

FURUNO

OPERATOR'S MANUAL

AUTOPILOT

Model **NAVpilot-1000**

FURUNO ELECTRIC CO., LTD.

9-52 Ashihara-cho,
Nishinomiya, 662-8580, JAPAN

• FURUNO Authorized Distributor/Dealer

All rights reserved. Printed in Japan

Pub. No. OME-72780-M1

(TAYA) NAVpilot-711C

A : OCT. 2013
M1 : NOV. 22, 2024



0 0 0 2 0 0 7 2 3 1 1

IMPORTANT NOTICES

General

- This manual has been authored with simplified grammar, to meet the needs of international users.
- The operator of this equipment must read and follow the instructions in this manual. Wrong operation or maintenance can void the warranty or cause injury.
- Do not copy any part of this manual without written permission from FURUNO.
- If this manual is lost or worn, contact your dealer about replacement.
- The contents of this manual and the equipment specifications can change without notice.
- The example screens (or illustrations) shown in this manual can be different from the screens you see on your display. The screens you see depend on your system configuration and equipment settings.
- Save this manual for future reference.
- Any modification of the equipment (including software) by persons not authorized by FURUNO will void the warranty.
- The following concern acts as our importer in Europe, as defined in DECISION No 768/2008/EC.
 - Name: FURUNO EUROPE B.V.
 - Address: Siriusstraat 86, 5015 BT, Tilburg, The Netherlands
- The following concern acts as our importer in UK, as defined in SI 2016/1025 as amended SI 2019/470.
 - Name: FURUNO (UK) LTD.
 - Address: West Building Penner Road Havant Hampshire PO9 1QY, U.K.
- Operation of the vessel is solely responsibility of the customer. FURUNO will not be not responsible for any damage associated with misuse of this equipment.
- All brand, product names, trademarks, registered trademarks, and service marks belong to their respective holders.

How to discard this product

Discard this product according to local regulations for the disposal of industrial waste. For disposal in the USA, see the homepage of the Electronics Industries Alliance (<http://www.eiae.org/>) for the correct method of disposal.

How to discard a used battery

Some FURUNO products have a battery(ies). To see if your product has a battery, see the chapter on Maintenance. If a battery is used, tape the + and - terminals of the battery before disposal to prevent fire, heat generation caused by short circuit.

In the European Union

The crossed-out trash can symbol indicates that all types of batteries must not be discarded in standard trash, or at a trash site. Take the used batteries to a battery collection site according to your national legislation and the Batteries Directive 2006/66/EU.

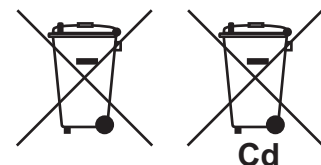

In the USA

The Mobius loop symbol (three chasing arrows) indicates that Ni-Cd and lead-acid rechargeable batteries must be recycled. Take the used batteries to a battery collection site according to local laws.

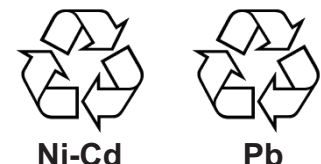



In the other countries

There are no international standards for the battery recycle symbol. The number of symbols can increase when the other countries make their own recycle symbols in the future.

















SAFETY INSTRUCTIONS

Follow the safety instructions listed below and throughout this manual to prevent damage to your equipment or vessel and to prevent harm to the operator or other personnel on-board. The results of failing to follow the instructions and guidelines outlined herein are listed below.

 WARNING	Indicates a condition that can cause death or serious injury if not avoided.
 CAUTION	Indicates a condition that can cause minor or moderate injury if not avoided.

 Warning, Caution	 Prohibitive Action	 Mandatory Action
--	--	---

 WARNING	
	Do not open the equipment unless you are well familiar with electrical circuits. Only qualified personnel should work inside the equipment.
	Turn off the power at the switchboard before beginning the installation. Fire or electrical shock can result if the power is left on.
	Do not change course when traveling at high speed. The boat may turn sharply, which results in an accident.
	Do not use auto steering in the following situations: - Speed 40 knots or higher - Navigating in a narrow channel - Entering or exiting a harbor - Area of heavy marine traffic - Cruising where the field of view is poor due to narrow visibility, fog, mist, or rain - Vessel is stopped
	Do not use the simulation mode on the boat. The rudder may move suddenly. This is a special-purpose mode for technicians.
	Do not use the ORBIT mode in rough seas. Because the boat turns a 360° circle around the waypoint, a large wave or strong wind can cause the boat to capsize.

 WARNING	
	Observe the following cautions when using the autopilot: - Maintain a vigilant watch - Watch for drifting of vessel
	In an emergency, manually steer the vessel. The autopilot cannot avoid vessels, etc. automatically.
	Before starting or resuming auto steering, confirm that the actual heading matches the heading shown on this autopilot. If the displayed heading is not the same as the actual heading, the vessel may be steered in an unexpected direction, which could result in an accident such as collision.
	For the figure-eight mode, confirm that no object is in the general vicinity of the waypoint. The distance from the waypoint to the turning point depends on boat's speed.
	Use the correct fuse. Use of a wrong fuse can cause fire or damage the equipment.
	Use the proper power cable. Use JIS type DPY-2.5 or the equivalent. Other types can cause fire.

WARNING

 **When connecting a geomagnetic heading sensor, correct magnetic field deviation.**

If an autopilot is used without the compensation, unexpected course change may occur.

 **Confirm that no one is near the rudder when bleeding air from oil cylinder.**

The rudder may move unexpectedly, possibly causing bodily injury.

 **Set [Remote Controller 1/2] on the [RC Setup] menu properly according to remote controller connected.**

If not done properly, malfunction may occur. Especially, take care when setting the NFU-type remote controller.

 **Install a control unit equipped with the STBY key, or an “auto steering cancel button” (local supply) at the helm and all steering stations, to disable rudder control by the autopilot in an emergency.**

An accident may result if the auto steering cannot be canceled immediately. To enable auto steering cancellation from an auto steering cancel button, set [In Port1] or [In Port2] to [Go STBY] on the [Universal Port] menu. See section 7.8.

CAUTION

 **Do not apply excessive force or shock to the LCD.**

The unit may be damaged.

 **In case of power failure, turn off the autopilot or manually steer the vessel.**

Leaving the equipment in the AUTO or NAV mode during power failure will cause wear on the rudder mechanism.

 **Do not use high-pressure cleaners to clean this equipment.**

This equipment has the waterproof rating outlined in the specifications, at the back of this manual. However, the use of high-pressure cleaning equipment can cause water ingress, resulting in damage to, or failure of, the equipment.

CAUTION

 **Confirm that the power supply voltage is compatible with the voltage rating of the equipment.**

Connection to the wrong power supply can cause fire or damage the equipment.

 **Observe the following compass safe distances to prevent interference to a magnetic compass:**

		Standard compass	Steering compass
Control Unit	FAP-7011C	0.50 m	0.35 m
	FAP-7001 (Option)	0.35 m	0.30 m
Processor Unit FAP-7002		0.45 m	0.30 m
Remote Controllers (Option)		0.30 m	0.30 m

 **Separate the reversible pump at least one meter from communications equipment, communications antenna and communications cabling to prevent interference.**

 **Keep the following points in mind when using Fantum Feedback™.**

The autopilot cannot detect the rudder position when using Fantum Feedback™. Therefore, over-steering after reaching rudder limit can occur. If over-steering continues, the drive unit may malfunction, preventing automatic steering. To prevent over-steering, keep the following points in mind.

- Use the autopilot within the speed at which the autopilot can control the vessel. Pay particular attention when keeping the stern facing windward (or into the current) in the SABIKI mode.
- Always check the rudder position to stop the rudder with the autopilot before reaching the rudder limit.
- When the rudder reaches rudder limit, the drive unit is temporarily disabled and the autopilot cannot move the rudder. If this occurs, the deviation alarm (see section 3.5) sounds regardless of the setting value. In this case, switch to the STBY mode and turn the helm to move the rudder.

SAFETY INSTRUCTIONS

WARNING LABEL

A warning label is attached to the processor unit. Do not remove the label. If the label is missing or damaged, contact your dealer about replacement.

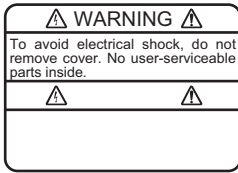

Name: Warning Label (1)
Type: 86-003-1011
Code No.: 100-236-231

About the TCT LCD

The TFT LCD is constructed using the latest LCD techniques, and displays 99.99% of its pixels. The remaining 0.01% of the pixels may drop out or blink, however this is not an indication of malfunction.

TABLE OF CONTENTS

FOREWORD.....	ix
SYSTEM CONFIGURATION	xi
EQUIPMENT LISTS.....	xii
1. OPERATIONAL OVERVIEW.....	1-1
1.1 Controls	1-1
1.2 How to Turn the Power On/Off	1-2
1.2.1 How to power the system	1-2
1.2.2 How to power off the system	1-2
1.3 How to Adjust the Brilliance.....	1-3
1.4 How to Set the Display Color.....	1-3
1.5 How to Select a Display.....	1-4
1.5.1 Graphic displays.....	1-4
1.5.2 Numerical display	1-7
1.5.3 How to select the display data.....	1-8
1.5.4 How to select the display data with the key operation (STBY mode only)	1-10
2. STEERING MODES.....	2-1
2.1 STBY Mode	2-1
2.2 AUTO Mode.....	2-2
2.2.1 How to get the AUTO mode	2-2
2.2.2 Advanced AUTO mode	2-3
2.3 NAV Mode	2-4
2.3.1 How to get the NAV mode.....	2-4
2.3.2 Sailing method for the NAV mode	2-5
2.3.3 Waypoint switching method.....	2-6
2.3.4 How to set the steering behavior of your boat after you arrive to a waypoint.....	2-6
2.4 Response Feature	2-7
2.4.1 How to activate the auto response feature.....	2-7
2.4.2 How to activate the manual response feature	2-7
2.5 TURN Mode.....	2-8
2.5.1 How to select a normal turn and start the turn	2-8
2.5.2 Types of normal turns.....	2-9
2.6 FishHunter™ Mode	2-10
2.6.1 How to select a FishHunter™ turn and start the turn	2-10
2.6.2 Types of FishHunter™ turns	2-13
2.6.3 How to set FishHunter™ turn parameters.....	2-16
2.7 SABIKI Mode (Outboard Vessels Only).....	2-18
2.7.1 How to use the SABIKI mode	2-19
2.7.2 How to adjust the SABIKI mode response	2-20
2.7.3 Rudder drive settings for the SABIKI mode.....	2-20
2.8 How to Navigate to a TLL Position	2-21
2.9 DODGE Mode	2-22
2.9.1 How to dodge in the AUTO and NAV modes	2-22
2.9.2 How to FU dodge in the STBY mode	2-22
2.9.3 How to NFU dodge in the STBY mode.....	2-22
2.10 REMOTE Mode	2-22
2.10.1 Dial-type remote controller (FAP-5551, FAP-5552)	2-22
2.10.2 Lever-type remote controller (FAP-6221, FAP-6222).....	2-23
2.10.3 Dodge-type remote controller (FAP-6231, FAP-6232)	2-24

TABLE OF CONTENTS

2.11 WIND Mode (for sailboats).....	2-25
2.11.1 How to get the WIND mode	2-25
2.11.2 Wind angle mode	2-26
2.11.3 TACK mode.....	2-27
2.11.4 Tacking in WIND mode (WIND TACK).....	2-29
2.11.5 How to reverse a heading change using the keys/knob.....	2-31
2.12 OVRD mode (for EVC system)	2-32
2.13 Safe Helm Mode	2-33
2.14 Power Assist Mode	2-34
3. ALARMS	3-1
3.1 Alarm Menu.....	3-1
3.2 Alarm Buzzer.....	3-1
3.3 Buzzer Interval	3-2
3.4 Watch Alarm.....	3-2
3.5 Deviation Alarm.....	3-2
3.6 XTE Alarm.....	3-3
3.7 Arrival Alarm.....	3-3
3.8 Speed Alarm	3-4
3.9 Depth Alarm	3-4
3.10 Water Temperature Alarm.....	3-5
3.11 Trip Distance Alarm, Trip Distance Reset	3-5
3.11.1 How to set the trip log alarm	3-5
3.11.2 How to reset the trip distance.....	3-6
3.12 Wind Alarms (for sailboats).....	3-6
3.12.1 Heading change alarm.....	3-6
3.12.2 Wind deviation alarm.....	3-7
3.12.3 True and apparent wind speed alarm	3-7
3.13 Alarm Log.....	3-8
4. USER MENU	4-1
4.1 Parameter Setup	4-1
4.1.1 Sea state	4-1
4.1.2 Trim gain	4-4
4.1.3 Speed calculation.....	4-5
4.2 Rudder Drive Level (For Fantum Feedback™).....	4-5
4.3 Net Towing	4-5
4.4 Course After Operation of a Remote Controller	4-6
4.5 Nav Data Source	4-6
4.6 NavNet vx2 Synchronization	4-7
4.7 Data Source Setup.....	4-8
4.7.1 Sensor sync	4-8
4.7.2 Data source selection.....	4-8
4.8 System Setup Menu	4-9
4.9 Menu Shortcuts	4-10
4.9.1 How to create a menu shortcut	4-10
4.9.2 How to delete a menu shortcut	4-11
5. MAINTENANCE, TROUBLESHOOTING.....	5-1
5.1 Preventive Maintenance.....	5-1
5.2 Replacement of Fuse	5-2
5.3 Diagnostics.....	5-2
5.3.1 Diagnostic menu	5-2
5.3.2 Processor unit test	5-3
5.3.3 Control unit test.....	5-3
5.3.4 EVC interface test.....	5-4

5.3.5	NMEA0183 test	5-5
5.3.6	CAN bus test	5-5
5.3.7	Key test	5-5
5.3.8	Screen test	5-6
5.3.9	Rudder test	5-6
5.3.10	Helm sensor test	5-10
5.4	System Data	5-11
5.5	Messages	5-11
5.5.1	Message pop-up display	5-11
5.5.2	Message board	5-12
5.5.3	Message description	5-12
5.6	Sensor in Use Display	5-14
6.	INSTALLATION AND WIRING	6-1
6.1	Installation	6-1
6.1.1	Installation location	6-1
6.1.2	When FAP-7011 is replaced with FAP-7011C	6-1
6.1.3	How to install the control unit	6-2
6.2	Wiring	6-4
6.2.1	Wiring notices	6-4
6.2.2	Connection with the processor unit	6-5
6.2.3	Auto steering cancel button	6-7
6.2.4	Connection for the interface kit	6-7
7.	INITIAL SETTINGS	7-1
7.1	How to Select Language and Units, Open the Installation Menu Window	7-1
7.2	Display Setup	7-2
7.3	Ship's Characteristics Menu	7-3
7.4	Dockside Setup Menu	7-4
7.4.1	Dockside setup for the rudder reference unit	7-5
7.4.2	Dockside setup for Fantum Feedback™	7-10
7.4.3	How to set the safe helm mode and power assist mode	7-13
7.4.4	Confirmation of the dockside setup	7-17
7.5	CAN bus Port Setup	7-19
7.6	NMEA0183 Port Setup	7-21
7.7	Data Source Setup	7-23
7.8	Universal Port Setup	7-24
7.8.1	GENERAL IN port setup	7-24
7.8.2	GENERAL OUT port setup	7-25
7.9	Sea Trial	7-26
7.9.1	How to calibrate the compass (PG-500/PG-700)	7-26
7.9.2	How to set the rudder deadband	7-28
7.10	Data Calibration	7-29
7.11	Parameter Setup Menu	7-29
7.11.1	Sea state	7-30
7.11.2	Trim gain	7-32
7.11.3	Speed calculation	7-33
7.12	AUTO Option Menu	7-33
7.13	NAV Option Menu	7-34
7.13.1	How to select the source for nav data	7-35
7.14	Fish Hunter Option Menu	7-36
7.15	Wind Option Menu	7-37
7.16	System Setup Menu	7-38
7.17	RC (Remote Controller) Setup Menu	7-38
7.18	All Clear (Default Setting)	7-39

TABLE OF CONTENTS

APPX. 1 MENU TREE	AP-1
APPX. 2 JIS CABLE GUIDE	AP-6
SPECIFICATIONS	SP-1
PACKING LIST	A-1
OUTLINE DRAWING	D-1
INTERCONNECTION DIAGRAM	S-1
INDEX.....	IN-1

FOREWORD

A Word to the Owner of the NAVpilot-711C

Congratulations on your choice of the NAVpilot-711C. We are confident you will see why the FURUNO name has become synonymous with quality and reliability.

Since 1948, FURUNO Electric Company has enjoyed an enviable reputation for innovative and dependable marine electronics equipment. This dedication to excellence is furthered by our extensive global network of agents and dealers.

Your equipment is designed and constructed to meet the rigorous demands of the marine environment. However, no machine can perform its intended function unless properly operated and maintained. Please carefully read and follow the operation and maintenance procedures set forth in this manual.

Thank you for considering and purchasing FURUNO.

We would appreciate feedback from you, the end-user, about whether we are achieving our goal.

Features

The NAVpilot-711C can steer a power boat or sailboat whose length is between 30 and 80 ft, and high-speed vessel (max. 40 kn).

The main features of the NAVpilot-711C are

- “Adaptive” technology allows NAVpilot to continually improve your vessel’s steering on every voyage
- Auto set-up and self-learning for vessel speed and course
- Versatile, high-resolution color LCDs provide a variety of user-defined display configurations
- One-touch operation for STBY, NAV and AUTO modes
- “FishHunter™” guides your vessel in circle, orbit, spiral, figure-eight, square or zigzag maneuver around fish or other target
- Network up to six control units

CE/UKCA declaration

With regards to CE/UKCA declarations, please refer to our website (www.furuno.com) for further information about RoHS conformity declarations.

Disclosure of Information about China RoHS

With regards to China RoHS information for our products, please refer to our website (www.furuno.com).

Operator's Guide

Operator's Guide gives you the basic information on the operation of this model.

Please visit our website from the following two dimensional code. Manuals for other models are also available on our website.



Operator's Guide is available in the following 11 languages.

- English
- French
- Spanish
- German
- Italian
- Portuguese
- Danish
- Swedish
- Norwegian
- Finnish
- Japanese

Each language has two pages.

SYSTEM CONFIGURATION

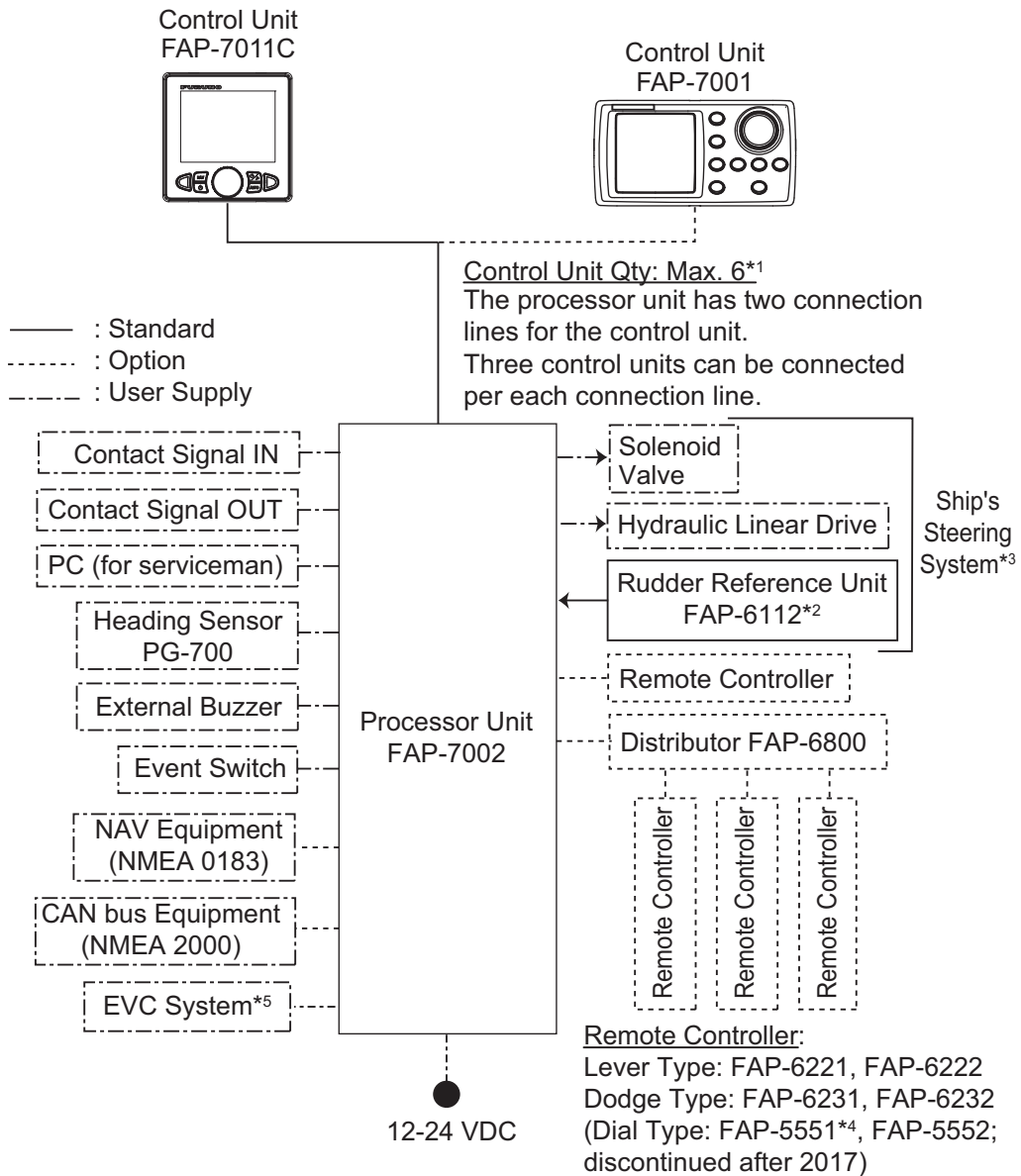

*1: Attach the terminator (type: BD-07AFFM-LR7001) to the port not used on the last control unit in the series.

*2: Not required for Fantum Feedback™ ([Rudder Sensor] = [Fantum Feedback]).

*3: Not required for a EVC system equipped vessel.

*4: Connect one Dial-type Remote Controller FAP-5551 to one Distributor FAP-6800.

*5: EVC systems compatible with the NAVpilot are as follows:

EVC System	Remarks
VOLVO PENTA IPS	Requires VOLVO interface kit FAP-6300 (available as an optional extra).
YAMAHA Helm Master	Requires YAMAHA HM interface kit FAP-6310 (available as an optional extra).
YANMAR VC10	<ul style="list-style-type: none"> Connect through the NMEA data converter IF-NMEA2K2 (ver.01.07 or later). Requires connector assembly AT06-2S-EC01-VCT-030 (available as an optional extra).
SEASTAR SOLUTIONS OPTIMUS	<ul style="list-style-type: none"> Connect through the NMEA data converter IF-NMEA2K2 (ver.01.16 or later). The software version of the connected Main PCM (Pump Control Module) must be "Rev. T" or later.

EQUIPMENT LISTS

Standard supply

Name	Type	Code No.	Qty	Remarks
Control Unit	FAP-7011C	-	1	
Processor Unit	FAP-7002	-	1	
Rudder Reference Unit	FAP-6112-200	-	1	May or may not be supplied depending on order.
Installation Materials	CP64-03101	001-082-720	1	For processor unit
	CP64-02601	009-001-170	1	For rudder reference unit May or may not be supplied depending on order.
Spare Parts	SP64-01501	001-082-710	1	For processor unit, fuse
Sponge	TZ8103008A	-	1	For control unit, installation materials
Cable Assy.	BD-07AFFM-LR-150	001-081-180-10	1	
Terminator	BD-07AFFM-LR-7001	001-081-140-10	1	For control unit, accessory
VOLVO Interface Kit	FAP-6300	000-036-494	1	May or may not be supplied depending on order.
YAMAHA HM IF Kit	FAP-6310	000-027-160		

Option supply

Name	Type	Code No.	Remarks
Control Unit	FAP-7001	-	Max. 5 optional units
	FAP-7011C	-	Max. 5 optional units
Remote Controller	FAP-6221	-	Lever Type, w/connector
	FAP-6222	-	Lever Type, no connector
	FAP-6231	-	Dodge type, w/connector
	FAP-6232	-	Dodge type, no connector
Rudder Reference Unit	FAP-6112-200	-	w/20 m cable
Junction Box	FI-5002	-	w/self-tapping screws
NMEA Data Converter	IF-NMEA2K2	-	
VOLVO Interface Kit	FAP-6300	000-036-494	For the EVC system equipped vessel
YAMAHA HM IF Kit	FAP-6310	000-027-160	
IPS Interface Unit	IF-700IPS	000-022-972	
VOLVO IPS Gateway	AUTOPILOT-GATEWAY	-	
YAMAHA HM Gateway	YAMAHA HM GATEWAY	-	
Distributor	FAP-6800	000-090-242	For connection of three remote controllers
Terminator	BD-07AFFM-LR7001	001-081-140-10	

Name	Type	Code No.	Remarks
Cable Assy.	MJ-A10SPF0001-060+	001-081-150-10	For distributor, 6 m
	MJ-A10SPF0001-120+	001-081-160-10	For distributor, 12 m
	BD-07AFFM-LR-100	001-081-170-10	For control unit, 10 m, connector at one end
	BD-07AFFM-LR-150	001-081-180-10	For control unit, 15 m, connector at one end
	BD-07AFFM-LR-200	001-081-190-10	For control unit, 20 m, connector at one end
	BD-07AF-07AF-LR-100	001-081-200-10	For control unit, 10 m, connector at both ends
	BD-07AF-07AF-LR-200	001-081-210-10	For control unit, 20 m, connector at both ends
	M12-05BFFM-010	000-167-965-10	CAN bus drop cable, 1 m, micro
	M12-05BFFM-020	000-167-966-10	CAN bus drop cable, 2 m, micro
	M12-05BFFM-060	000-167-967-10	CAN bus drop cable, 6 m, micro
	CB-05BFFM-010	000-167-971-10	CAN bus drop cable, 1 m, micro, mini
	CB-05BFFM-020	000-167-972-10	CAN bus drop cable, 2 m, micro, mini
	CB-05BFFM-060	000-167-973-10	CAN bus drop cable, 6 m, micro, mini
T-Connector	SS-050505-FMF-TS001	000-168-603-10	For CAN bus, micro+micro
	NC-050505-FMF-TS001	000-160-507-10	For CAN bus, mini+micro
Termination Resistor	LTWMC-05BMMT-SL8001	000-168-604-10	For CAN bus, micro, male
	LTWMN-05AMMT-SL8001	000-160-508-10	For CAN bus, mini, male
	LTWMC-05BFFT-SL8001	000-168-605-10	For CAN bus, micro, female
	LTWMN-05AFFT-SL8001	000-160-509-10	For CAN bus, micro, male
Connector Assembly	AT06-2S-EC01-VCT-030	000-193-626-10	For connection with Yanmar VC10
Flush Mount Kit	FAP-7001-FLUSH-KIT	001-082-730	For FAP-7001
Bracket Assembly	FAP-7001-BRACKET	001-082-750	For FAP-7001
	OP64-12	001-434-490	For FAP-7011C
	OP64-2	009-004-030	For FAP-5551/5552
Flush Mount Kit	OP64-4	009-005-790	For FAP-6221/6222, panel type
	OP64-5	009-005-800	For FAP-6221/6222, surface type
Operator's Guide	MLG-72780-*	000-178-291-1*	Hard copy manual, Multi-language

Discontinued products

The following products are discontinued:

Name	Type	Date
Remote Controller	FAP-5551	December, 2017
	FAP-5552	December, 2017

This page is intentionally left blank.

1. OPERATIONAL OVERVIEW

1.1 Controls

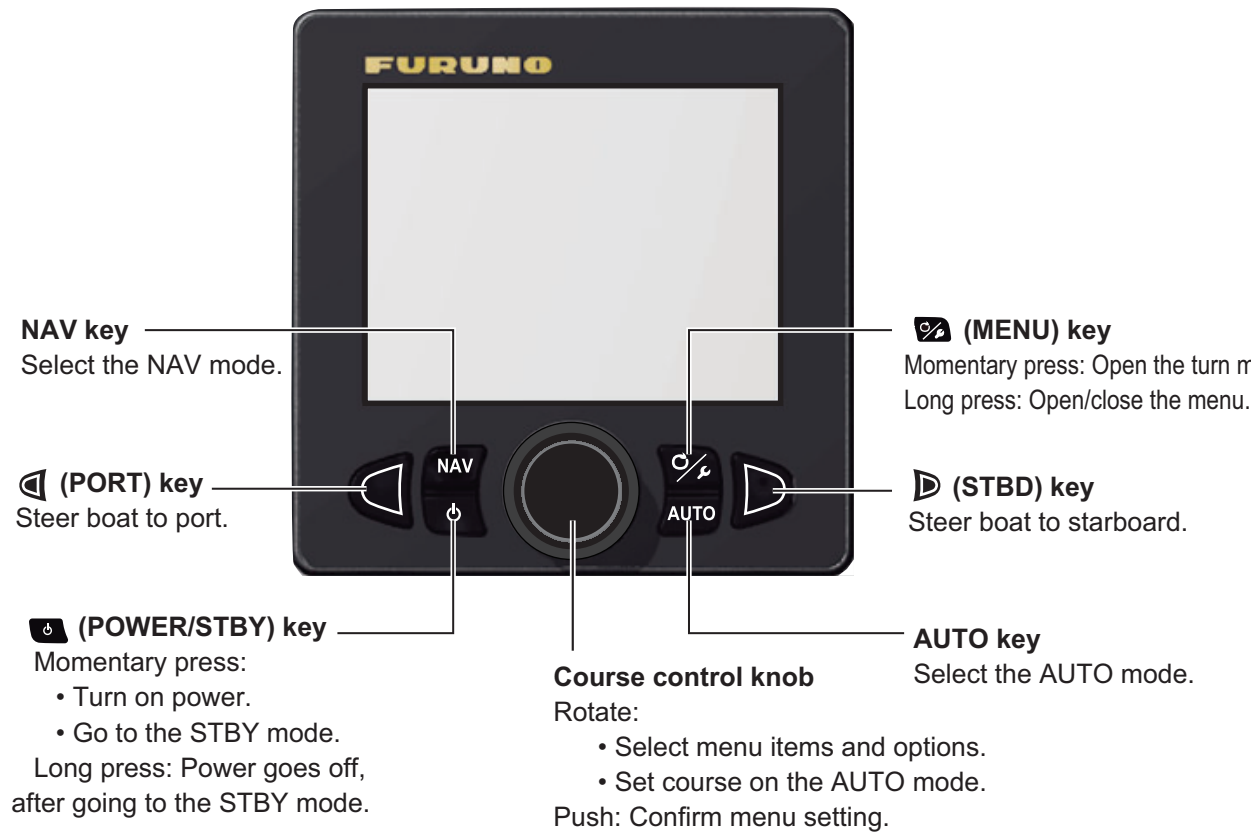

Press and hold the **(POWER/STBY) key**, then press the **AUTO** key to get the WIND mode (sailboats only).

1.2 How to Turn the Power On/Off

Note: When the heading sensor is PG-500/PG-700/Satellite Compass™, do not set sail for four minutes after turning on the heading sensor. This allows time for the heading sensor to output heading data.

1.2.1 How to power the system

Press the  key to power the system. A beep sounds and the result of the start up test appears followed by the start screen. The startup test checks the ROM, RAM, backup data of the processor unit and control unit, etc. The test also checks for rudder angle information from the rudder reference unit.

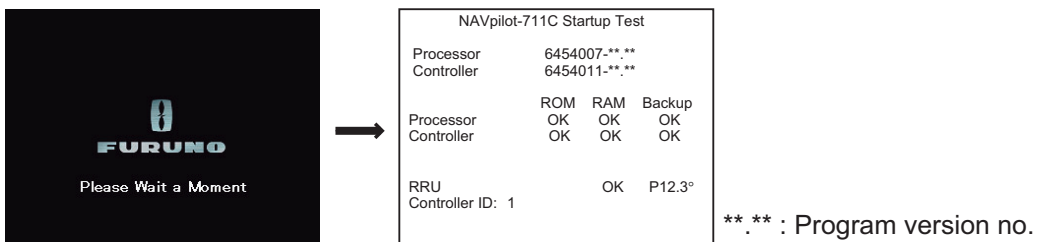

Note: The content of the startup test changes according to your system configuration.

If “NG” appears for any item, an error message, shown in the table below, appears. Follow the information provided in the message to restore normal operation. If you cannot restore normal operation, contact your dealer.

Error message	Meaning
System has failed startup test. Please contact a local FURUNO representative for repair if problem re-occurs.	The system has failed the start up test.
Back-up data is corrupt factory defaults will be restored (processor). Push any key to continue.	Backup data of the processor unit is corrupted.
Back-up data is corrupt factory defaults will be restored (controller). Push any key to continue.	Backup data of the control unit is corrupted.
EVC Interface has failed startup test. Please contact a local FURUNO representative for repair. Push any key to continue.	System error of the IPS interface unit or NMEA data converter. Turn off the autopilot, contact your dealer.
No connect EVC Interface. Please check the EVC Interface. Push check the heading sensor.	The IPS interface unit or NMEA data converter is not connected. Check the connection with IPS interface unit or NMEA data converter.

1.2.2 How to power off the system

Long press the  key to power off the system. While pressing the key, the display shows the number of seconds remaining until the power is turned off.

1.3 How to Adjust the Brilliance

1. Long press the  key to open the menu.

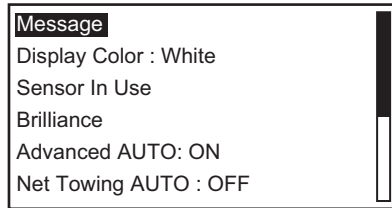

2. Rotate the **Course control** knob to select [Brilliance] then push the knob. The brilliance adjust window appears. The window closes automatically when there is no operation for a while.

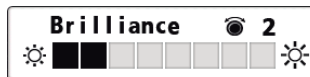

3. Rotate the **Course control** knob to adjust the brilliance. The higher the value, the brighter the display.
4. Push the **Course control** knob to close the window.
5. Push the  key to close the menu.

1.4 How to Set the Display Color

1. Long press the  key to open the menu.

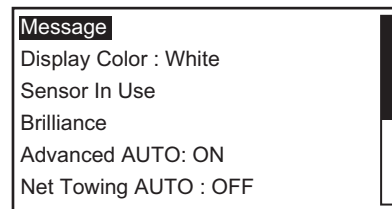

2. Rotate the **Course control** knob to select the current setting for [Display Color] then push the knob.
3. Rotate the **Course control** knob to select the display color.
[White]: White-themed display
[Black]: Black-themed display

Example: [Display Color] = [White]

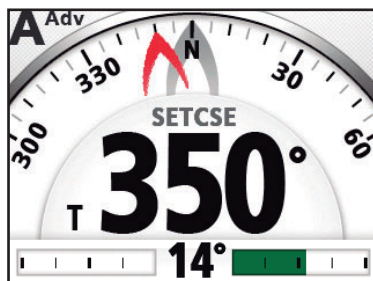

Example: [Display Color] = [Black]

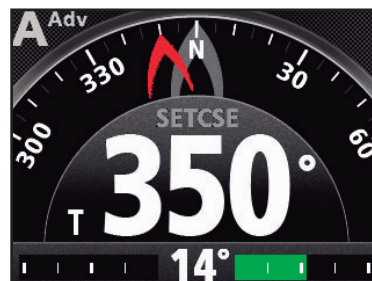

4. Push the  key to close the menu.

1.5 How to Select a Display

There are three displays to select from each steering mode.

To select a display, do the following operation according to the steering mode.

- STBY mode: Press the  key
- AUTO and WIND mode: Press the **AUTO** key.
- NAV mode: Press the **NAV** key.

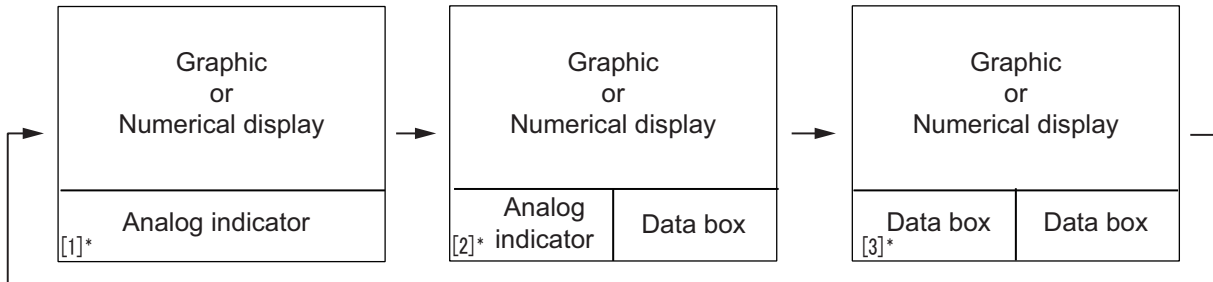

*: Page no. appears when selecting display.

Note: Page layout of the page 3 depends on setting of [Data Box Format].

1.5.1 Graphic displays

There are five types of the graphic displays: compass, highway, wind, rudder, engine speed display.

Compass display

The compass display show ship's heading data. The compass rotates to keep the ship's heading (gray pointer) at the top of the display. Requires heading data.

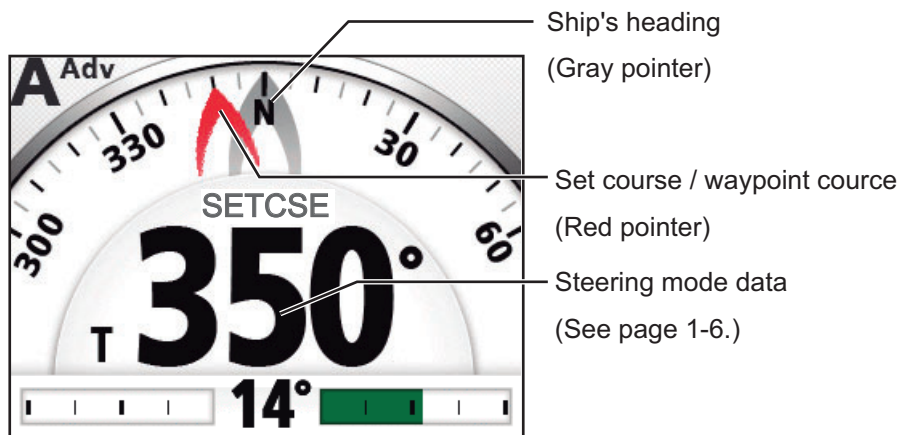

Highway display

The highway display provides a graphic presentation of your boat's progress along its intended course. The own ship marker moves according to your boat's track to the waypoint.

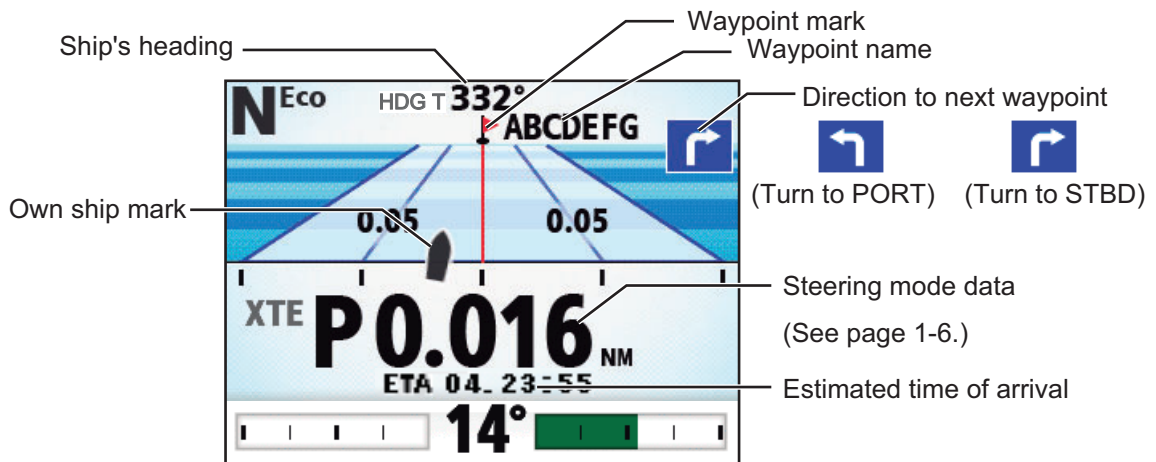

Wind display

The wind display shows wind angle and wind speed. The data can be shown in true wind or apparent wind. The **apparent wind** is the actual flow of air acting upon a sail, or the wind as it appears to the sailor. The **true wind** is the wind seen by a stationary observer in velocity and direction. Requires a wind sensor.

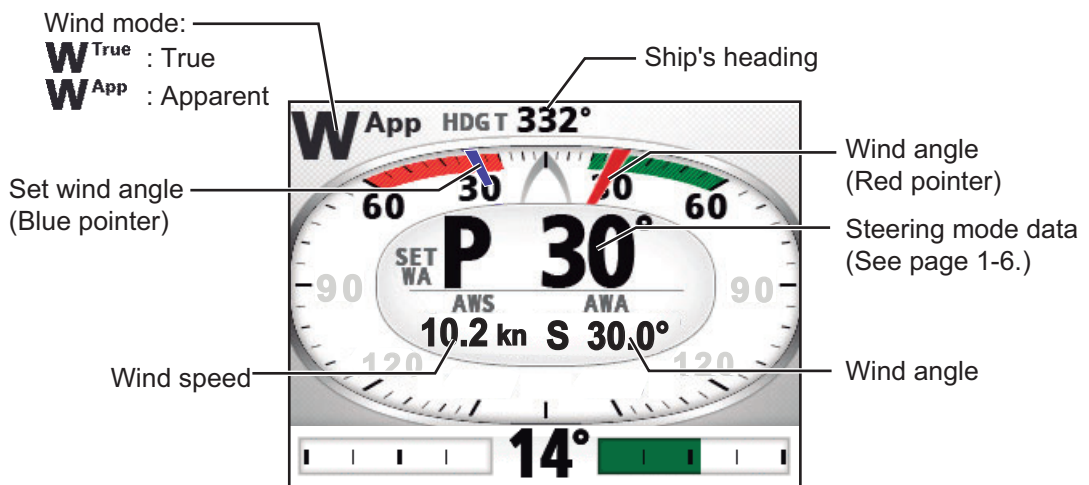

1. OPERATIONAL OVERVIEW

Rudder display

The rudder display shows analog and digital rudder angle.

Note: Not available with Fantum Feedback™.

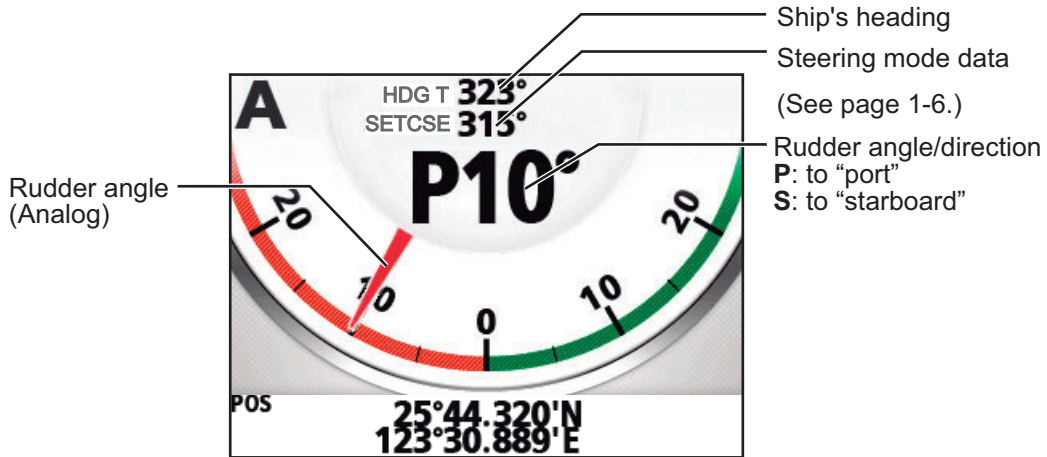

Engine speed display

The engine speed display shows the engine revolution. Requires engine speed data.

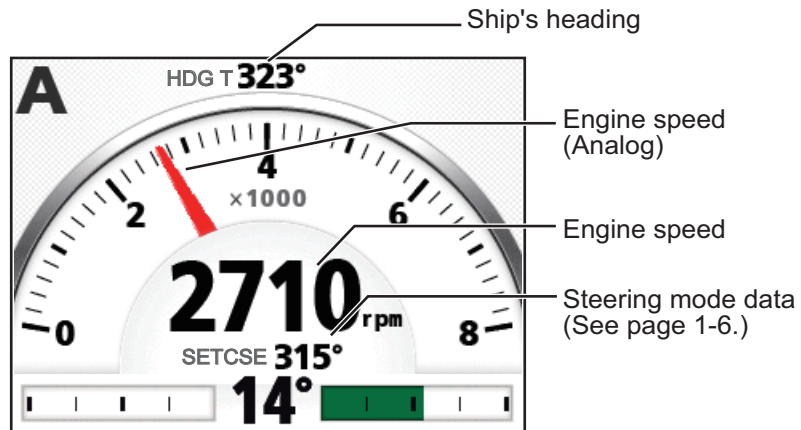

Steering mode data

The table below shows the steering mode data that appears on the graphic display.

Steering mode	Display
STBY mode	Ship's heading
AUTO mode	Set course
NAV mode [NAV mode] = [Course]	Waypoint course
NAV mode [NAV mode] = [XTE(Precision)] or [XTE(Economy)]	Cross-track error
WIND mode	Set wind angle

1.5.2 Numerical display

The numerical display provides relevant navigation data according to the steering mode, on three screens.

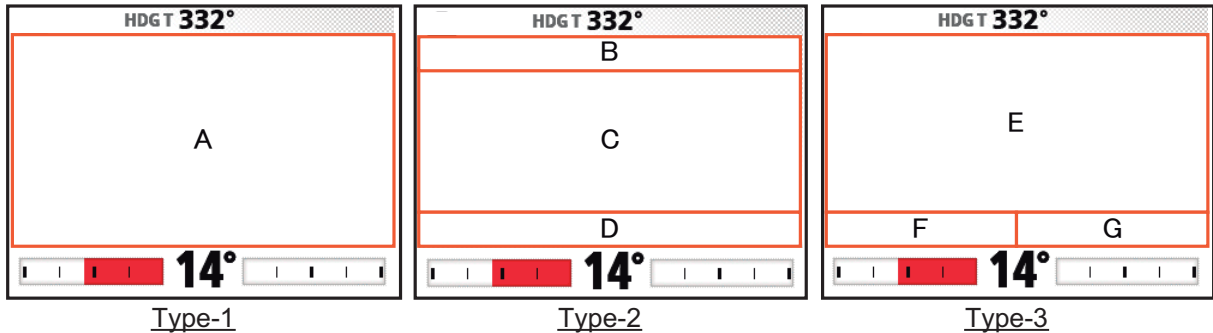

The table below shows the layout and data provided with each steering mode.

Steering mode	Layout	Display data
STBY mode	Type-1	A: Ship's heading
AUTO mode	Type-1	A: Set course
NAV mode ([NAV mode] = [Course])	Type-2	B: Waypoint name C: Waypoint course D: ETA (Estimated time of arrival)
NAV mode ([NAV mode] = [XTE(Precision)] or [XTE(Economy)])	Type-2	B: Waypoint name C: Cross-track error D: ETA (Estimated time of arrival)
WIND mode	Type-3	E: Set wind angle F: Wind speed G: Wind angle

1.5.3 How to select the display data

You can select the display data to show in the STBY, AUTO, NAV, and WIND modes.

1. Long press the  key to open the menu.
2. Rotate the **Course control** knob to select [Other Menu] then push the knob.
3. Rotate the **Course control** knob to select [System Setup] then push the knob.
4. Rotate the **Course control** knob to select [Display Data Select Menu] then push the knob.

The window as shown below appears.

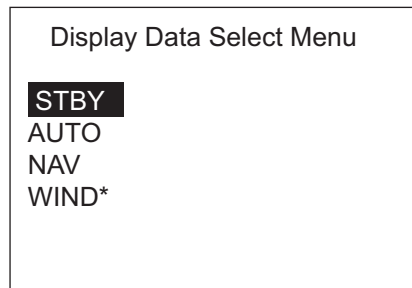

*: Sailboats only

5. Rotate the **Course control** knob to select the steering mode desired then push the knob.
6. Rotate the **Course control** knob to select the current setting for display division desired then push the knob.

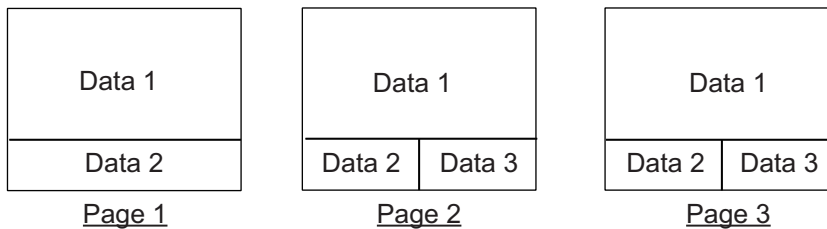

Note: Page layout of the page 3 depends on setting of [Data Box Format].

7. Rotate the **Course control** knob to select display data desired then push the knob.

The table below shows all the display data available.

Page/Data	Data Displayed	Data meaning
Graphic / numerical data Page 1: [Data 1] Page 2: [Data 1] Page 3: [Data 1]	[Normal]	Numerical display (see section 1.5.2)
	[Compass]	Compass rose
	[Highway]	Graphic presentation of progress towards waypoint
	[Wind Apparent]	Analog and digital apparent wind direction speed
	[Wind True]	Analog and digital true wind direction speed
	[Rudder]* ¹	Analog and digital rudder angle
	[Engine Speed]	Analog engine speed (revolution meter)
Analog indicator Page 1: [Data 2] Page 2: [Data 2]	[Rudder]* ¹	Rudder angle
	[Deviation]	Heading deviation For WIND mode, wind deviation
	[Steering Direction]* ²	Steering direction

Page/Data	Data Displayed	Data meaning
Data box Page 2: [Data 3] Page 3: [Data 2] / [Data 3]* ³	[POSN]	Own ship's position data
	[COG]	Course over ground
	[SOG]	Speed over ground
	[STW]	Speed through water
	[Temp]	Water temperature
	[DPTH]	Depth
	[BRG]	Bearing to waypoint
	[RNG]	Range to waypoint
	[WPT]	Waypoint position (Latitude/Longitude)
	[XTE]	Cross-track error
	[TTG]	Time-to-go to waypoint
	[ETA]	Estimated time of arrival to waypoint
	[Date]	Current date
	[Time]	Current time
	[Wind Apparent]	Apparent wind direction/speed
	[Wind True]	True wind direction/speed
	[Volt]	Input/output voltage to processor unit
	[Trip]	Trip distance
	[Air Temp]	Air temperature
	[Atmos Press.]	Atmospheric pressure
[Humidity]	Humidity	
[Dew Point]	Dew point	

*1: Not shown with Fantum Feedback™.

*2: Shown with Fantum Feedback™.

*3: Shown when [Data Box Format] = [2Boxes].



Note: When input data for following items exceed the display range, the NAVpilot indication changes to show an asterisk with the upper (or lower) limit value. For example, when input data for SOG exceed the upper limit, the NAVpilot indicates “*99.9kn”.

- Air Temp
- Atmos Press.
- BRG
- DPTH
- Humidity
- RNG
- SOG
- STW
- Temp
- Trip
- Volt
- Wind Apparent
- Wind True
- XTE
- Rudder



8. Push the  key several times to close the menu.

1.5.4 How to select the display data with the key operation (STBY mode only)

You can select the display data to show in the STBY mode with the key operation.

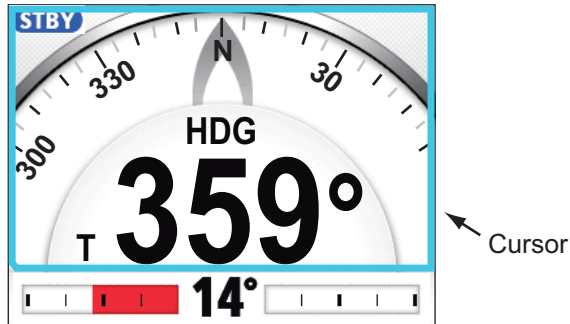
1. Short press the  key to go to the STBY mode.
2. Press the  key again to select a display.
3. Long press the **Course control** knob.
The item selected by the cursor is circumscribed with a thick rectangle, as in the illustration below.



4. Press the  or  key to put the cursor on the data to change.
5. Rotate the Course control knob to select the display data then push the knob.

2. STEERING MODES

This chapter describes the steering modes and functions of the NAVpilot.

Note: If the auto steering cancel button (local supply) is installed, the button cancels auto steering then switches to manual steering (STBY mode).

Cautions when switching steering modes

- **PG-500 or PG-700 heading sensor**
 - The message "Initializing heading sensor. This takes two minutes, please wait." may appear when switching steering modes. In this case, wait approx. two minutes to allow for initialization of the heading sensor, then switch steering modes.
 - When the heading sensor is restarted because of power supply interruption, etc. while the autopilot is controlling the rudder, the message indicated above appears and the autopilot stops the rudder control. If this happens, switch to the STBY mode, then steer the vessel manually.
- **Satellite Compass™ heading sensor**
 - The heading may not be output immediately after the Satellite Compass™ is powered on. Wait until the heading appears on the display.
 - The Satellite Compass™ may not be able to calculate heading when entering an area where satellites are blocked (for example, under a bridge). When this occurs, the message "Missing heading data" appears and the autopilot stops. Immediately switch to the STBY mode, then steer manually until the heading appears on the display.

2.1 STBY Mode

After turning on the power, the equipment goes to the STBY mode. This is a manual steering mode. When sailing into or out of a harbor, steer the vessel in the STBY mode by using the steering wheel (helm) of your boat. In the STBY mode, "STBY" appears on the display.

The compass rotates to keep the ship's heading (gray pointer) at the top of the display.

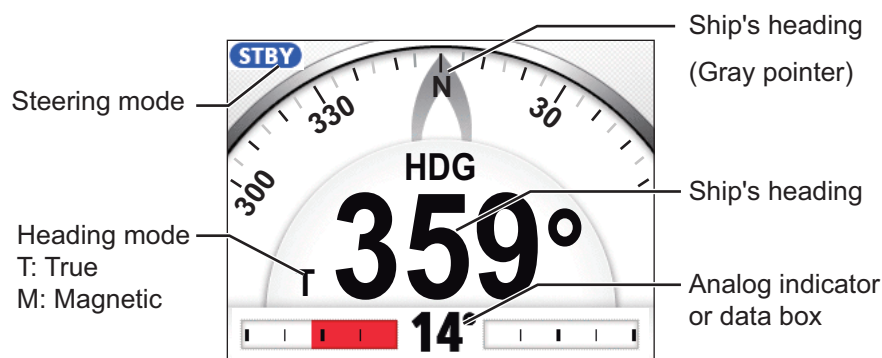

Display example: STBY mode

2.2 AUTO Mode

The AUTO mode steers the boat automatically on a course set by the operator.

The AUTO mode will not compensate for the effects of wind or tide, which can push you off course athwart in the ship direction. Use the AUTO mode for short, straight voyages. Otherwise switch to the NAV mode (see section 2.3).

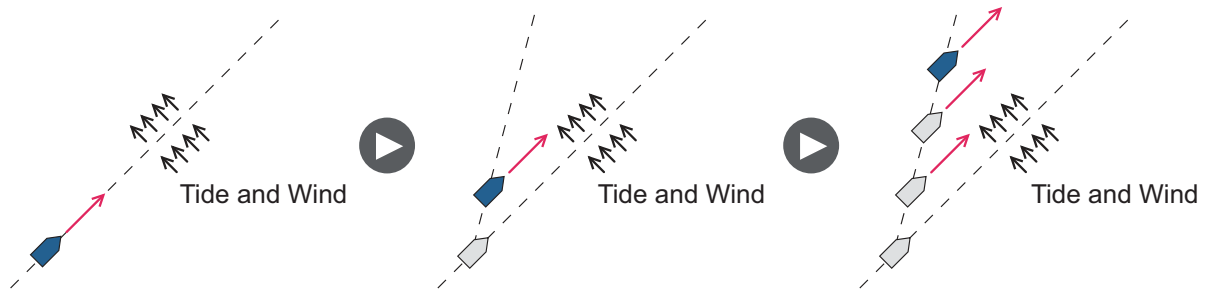

2.2.1 How to get the AUTO mode

To get the AUTO mode, do as follows:

1. Direct the boat toward required course.
2. Press the **AUTO** key to activate the AUTO mode.
Your boat automatically maintains the current course when the **AUTO** key is pressed. When the heading changes from the set course, the NAVpilot automatically adjusts the rudder to return the boat to the set course.
In the AUTO mode, the steering indication at the top left corner of the display shows "A".
The compass rotates to keep the ship's heading (gray pointer) at the top of the display.

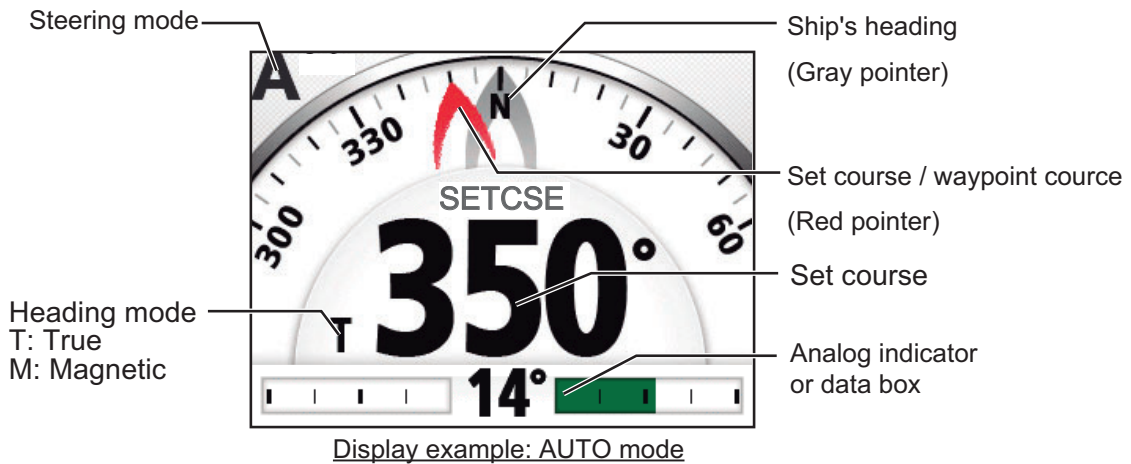

3. To change the course setting in the AUTO mode, rotate the **Course control** knob to the required course.
4. To exit the AUTO mode to steer manually, press the  key. Steer your boat by the helm.

2.2.2 Advanced AUTO mode

The AUTO mode keeps a set course, but your boat's course can change by the effects of tide and wind. To adjust for the effects of tide and wind, use the Advanced AUTO mode. The NAVpilot calculates your course according to your current position and heading, then sets a virtual "waypoint" in its memory to navigate towards. If either tide or wind begins to push you off course, the NAVpilot corrects your heading accordingly.

For use of the Advanced AUTO mode, connect a GPS navigator which outputs position data (Latitude and Longitude) to the NAVpilot.

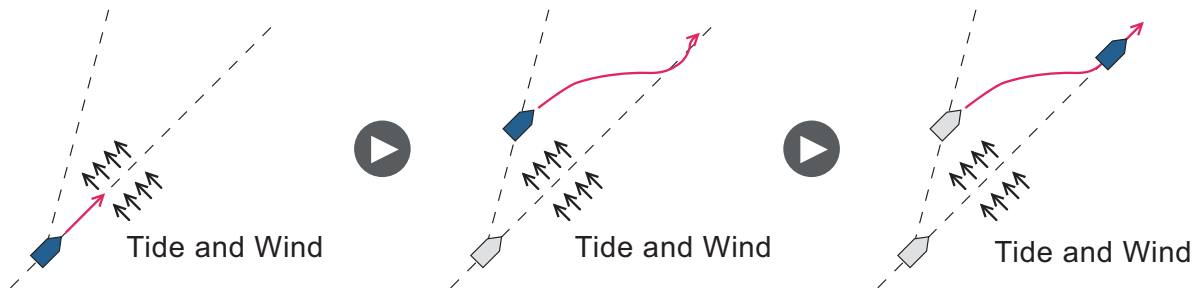

To get the Advanced AUTO mode, do as follows:

1. In the AUTO mode, long press the  key to show the menu.
2. Rotate the **Course control** knob to select the current setting for [Advanced AUTO] then push the knob. [Advanced AUTO] also appears on the [AUTO Option] menu.



3. Rotate the **Course control** knob to select [ON] then push the knob. The steering indication at the top left corner of the display changes as below. Select [OFF] to quit the Advanced AUTO mode.

A Adv

Note: When the position data is not input, the pop-up message "No Position Data" appears and audio alarm sounds. Press any key to stop the alarm, then confirm the connection with the GPS navigator.

4. Press the  key to close the menu.

You can switch between AUTO and Advanced AUTO modes by holding down the **AUTO** key three seconds to show the message "Advanced AUTO ON (OFF)".

Note: How strictly the Advanced AUTO mode keeps the course depends on the [NAV Mode] setting in the [NAV Option] menu.

[NAV Mode] setting

- [Course] and [XTE(Economy)] : Keeps the course within 0.03 NM.
- [XTE(Precision)] : Keeps the course within 0.01 NM.

2.3 NAV Mode

NAVpilot steers the vessel towards the current waypoint while compensating for the effects of tide and wind.

When connected to a GPS navigator, NAVpilot steers the vessel to follow a series of waypoints in sequence. When you arrive at each waypoint or destination, audible and visual alerts are activated.

The NAVpilot takes 15 seconds to activate the NAV mode after the NAVpilot receives the destination information.

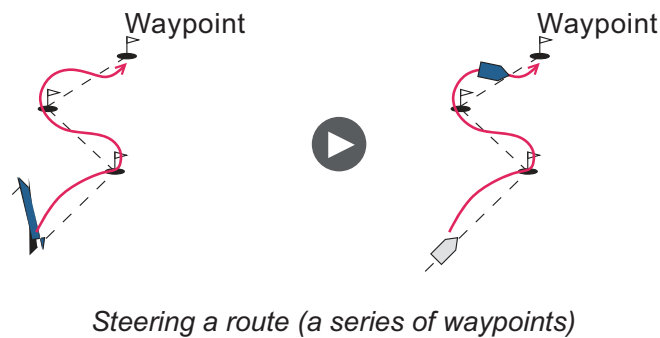
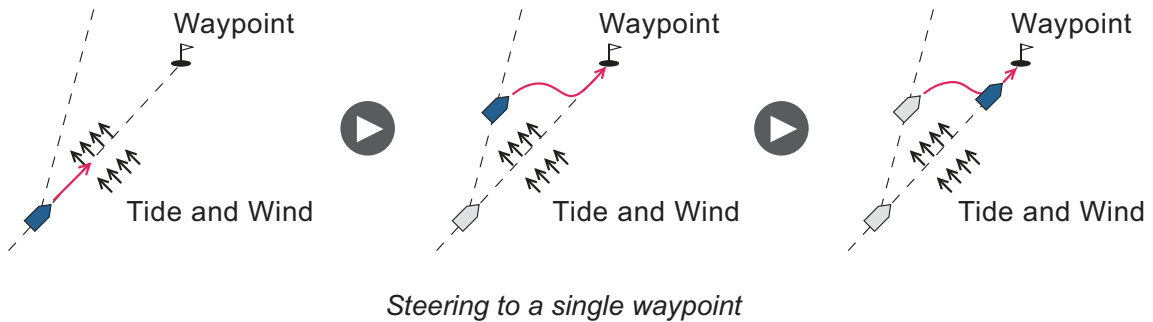

2.3.1 How to get the NAV mode

To get the NAV mode, do as follows:

1. Set the destination waypoint (or route) on the GPS navigator or chartplotter.
To navigate a route, make sure that your plotter is navigating towards the nearest or required waypoint before you put the NAVpilot into the NAV mode.
2. Manually steer the boat toward the waypoint.
3. Press the **NAV** key.
You are asked if you are sure to navigate to the waypoint selected.

4. Push the **Control course** knob to start to navigate to the waypoint.

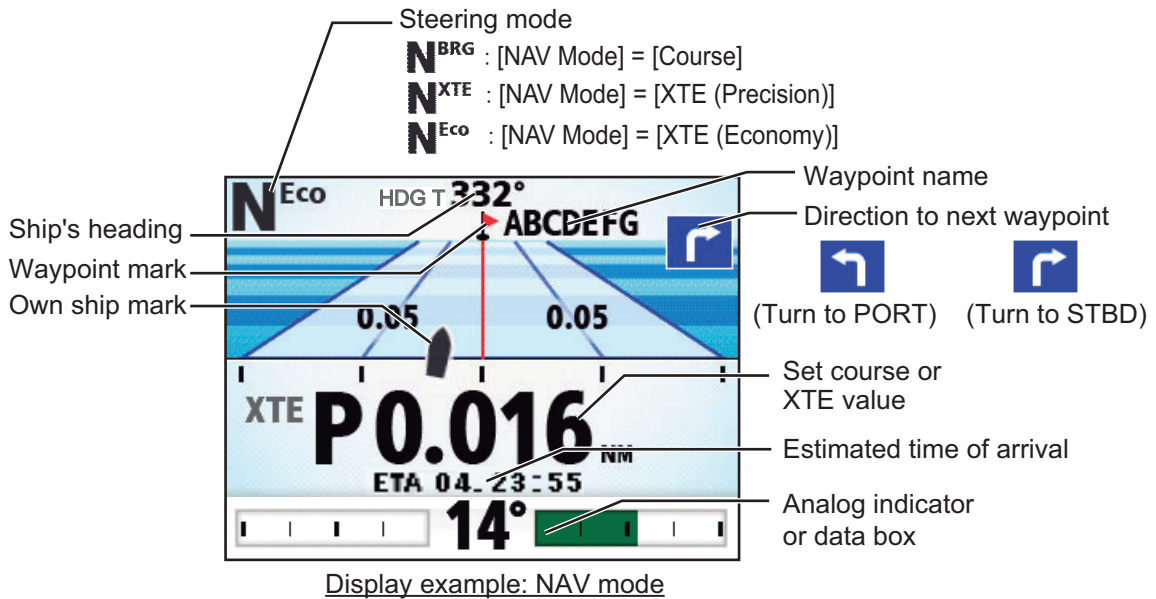

Note: The course reading on the NAVpilot is not always the same as the waypoint direction shown on the chartplotter.

2.3.2 Sailing method for the NAV mode

Your vessel can go off course between waypoints in the NAV mode. This can occur when, for example, a command is received from a remote controller. To return to the course set, three methods are available: [Course], [XTE (Precision)], and [XTE (Economy)].

- [Course]: The NAVpilot calculates a new course according to your new position (after dodging, etc.) that takes you directly to your destination waypoint.
- [XTE (Precision)] and [XTE (Economy)]: The NAVpilot uses the XTE (cross-track error) value to steer the boat towards your ORIGINAL course before dodging. [XTE (Precision)] provides for tighter course keeping, within 0.01 NM of the set course. [XTE (Economy)] gives less tighter course keeping, within 0.03 NM of the set course.

Note: [Course] is not available with Fantum Feedback™.

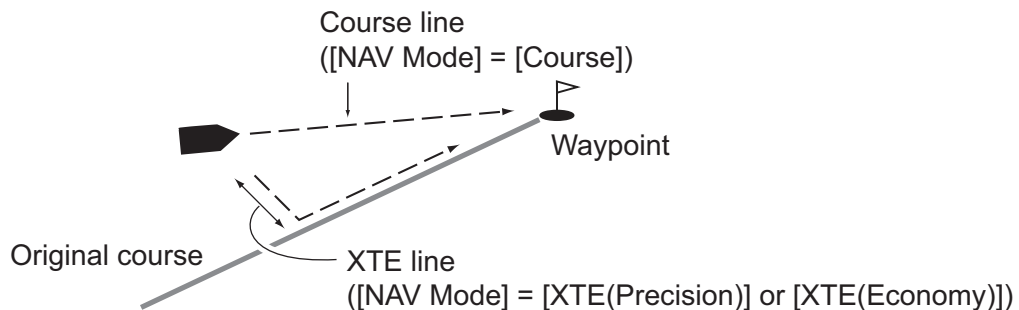

Select the sailing method as shown below.

1. In the NAV mode, long press the key to show the menu.

2. STEERING MODES

2. Rotate the **Course control** knob to select the current setting for [NAV Mode] then push the knob.
[NAV Mode] also appears on the [NAV Option] menu.

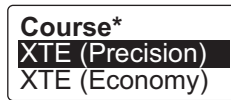

*: Not shown with Fantum Feedback™.

3. Rotate the **Course control** knob to select an option then push the knob.
4. Press the  key to close the menu.

Note: You can switch between [XTE (Precision)] and [XTE (Economy)] at any time in [NAV mode]. To switch, press and hold the **NAV** key. If [NAV mode] is set to [Course], press and hold the **NAV** key to switch to [XTE Precision], then release the **NAV** key. The shortcut now switches between [XTE (Precision)] and [XTE (Economy)].

2.3.3 Waypoint switching method

When you arrive at a waypoint on a route in the NAV mode, you can switch to the next waypoint automatically or manually.

Select waypoint switching method as follows:

1. In the NAV mode, long press the  key to show the menu.
2. Rotate the **Course control** knob to select the current setting for [Waypoint Switching] then push the knob.
[Waypoint Switching] also appears on the [NAV Option] menu.





3. Rotate the **Course control** knob to select an option then push the knob.
[Auto]: Switches to the next destination waypoint when your boat is within the arrival alarm area (set on the chartplotter). When your boat is within the arrival alarm area, the buzzer sounds for five seconds and the message "WPT was changed." appears.
[Manual]: Requires operator confirmation (pushing the **Course control** knob) before switching to the next waypoint. For manual switching, the NAVpilot sounds a five-second alarm when the vessel arrives at the destination waypoint. The message "Push any key to turn." appears. Push any key. Then, the message "WPT was changed." appears.
4. Press the  key to close the menu.

2.3.4 How to set the steering behavior of your boat after you arrive to a waypoint

When you arrive to the last waypoint in a route, the FishHunter™ mode can be activated automatically to steer the boat according to the FishHunter™ mode preset. For details of each preset, see section 2.6.

This function is not available with a sailboat.

To enable the FishHunter™ mode and set the steering behavior, do as follows:

1. In the NAV mode, long press the  key to show the menu.
2. Rotate the **Course control** knob to select the current setting for [After Arrival] then push the knob.
[After Arrival] also appears on the [NAV Option] menu.
For Fantum Feedback™, only [GO Straight] and [Orbit to STBD] appear.
 - [GO Straight]: Cruise straight after arriving at the last waypoint.
 - [Orbit to PORT]: Orbits to PORT around waypoint.
 - [Orbit to STBD]: Orbits to STBD around waypoint.
 - [Figure Eight PORT]: Turns to PORT in a figure-eight pattern.
 - [Figure Eight STBD]: Turns to STBD in a figure-eight pattern.
 - [Square PORT]: Turns to PORT in a square pattern.
 - [Square STBD]: Turns to STBD in a square pattern.
3. Rotate the **Course control** knob to select an option then push the knob.
4. Press the  key to close the menu.

GO Straight
Orbit to PORT
Orbit to STBD
Figure Eight PORT
Figure Eight STBD
Square PORT
Square STBD

2.4 Response Feature

The response feature provides for simple setting of the NAVpilot's parameter to counter the effects of wind, etc. Normally, use the auto response feature (see section 2.4.1). If you feel that the auto response feature is not working properly, adjust the response feature manually (see section 2.4.2). This feature is available in the following conditions:

- AUTO, NAV, WIND modes
- [Sea State] is set for [Full-Auto] or [Semi-Auto]. For the setting of [Sea State], see section 4.1.1.

2.4.1 How to activate the auto response feature

1. Push the **Course control** knob to show the [Response] window.
2. Press the  key to select [Auto].

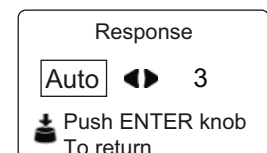

3. Push the **Course control** knob to confirm your setting and close the window.

2.4.2 How to activate the manual response feature

1. Push the **Course control** knob to show the [Response] window.

2. STEERING MODES

2. Press the  key to select the current setting value.

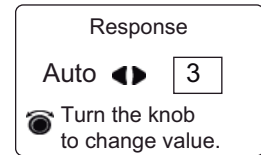

3. Rotate the **Course control** knob to set response level (setting range: 1-9).
Raise the response level to get back on course when external interference (wind, etc.) is pushing the boat off course.
4. Push the **Course control** knob to close the window.

2.5 TURN Mode

The TURN mode has two types: normal turn and FishHunter™ mode turn. For FishHunter™ mode turn, see section 2.6.

Note 1: Turn mode is not available with a sailboat.

Note 2: FishHunter™ mode turn is not available with Fantum Feedback™.

2.5.1 How to select a normal turn and start the turn

The normal turn provides three preset turning motions: 180°, 360°, and user turn. These turns are available in the AUTO and NAV mode and in clockwise and counter clockwise directions.

Select the 180°, 360°, or user turn as follows:

1. Press the  key to show the turn menu.

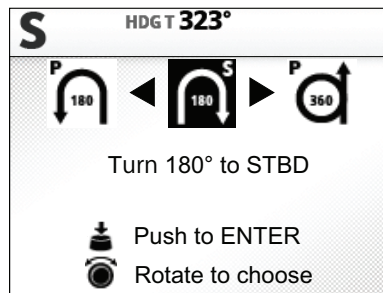

2. Rotate the **Course control** knob to select a turn.
The cursor highlights current selection. See section 2.5.2 and section 2.6.1 for description of turns.

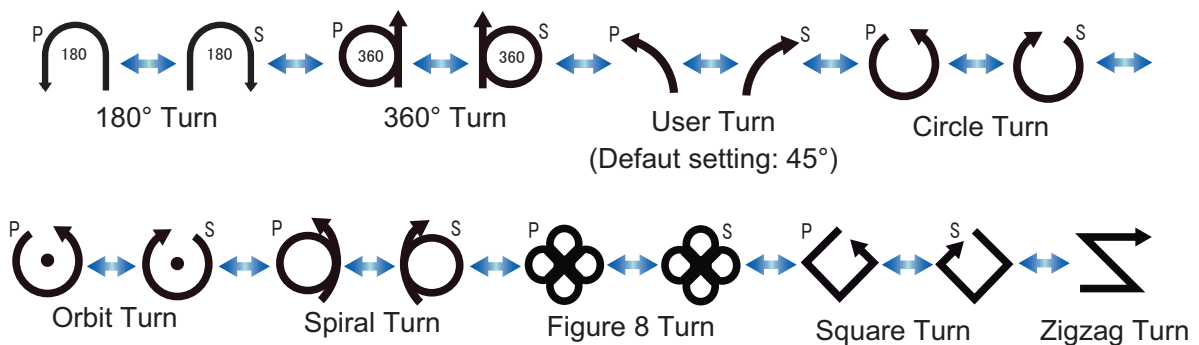

Note 1: You can set the parameters for the user turn (before starting the turn) by pressing the **D** key. For details, see "User turn" on page 2-9.

Note 2: Only 180°, 360°, and user turn are available with Fantum Feedback™.

3. Push the **Course control** knob to start the turn.

After you start the turn, the message "Beginning turn" appears, and the alarm sounds three times.

During the turn, the ship mark, which indicates own ship's course movement, appears on the turn display. The ship mark does not show accurate ship's movement.

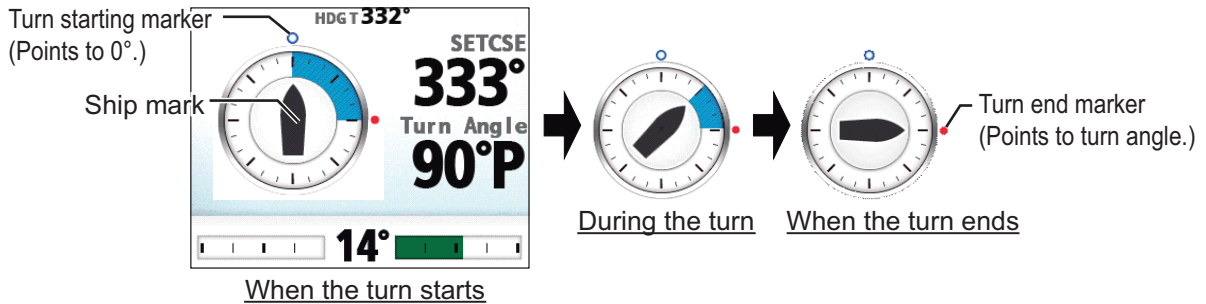

After the turn is completed, the message "Turn ended" appears, and the alarm sounds three times.

2.5.2 Types of normal turns

180° turn

This function changes the current set course by 180° in the opposite direction. This feature is very useful in a man overboard situation and whenever you want to steer back on a reciprocal heading.

360° turn

This function also provides a continuous turn feature with a constant rate of turn in a circle. This feature is useful in purse seining.

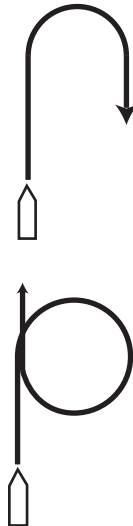

User turn

You can set desired turn angle with this turn, from 15° to 360° in 15° degree increments.

1. Press the **U** key to show the turn menu.
2. Rotate the **Course control** knob to select the user turn icon.



2. STEERING MODES

- Press the  key to set the turn angle for the user turn.

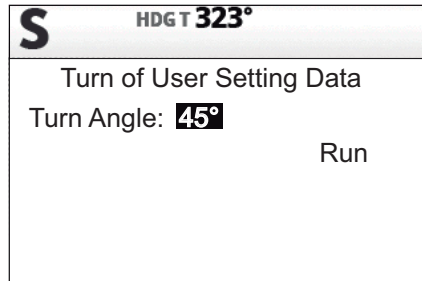

- The cursor is selecting the value for [Turn Angle]; push the **Course control** knob. The turn angle of the user turn can also be set at [System Setup] menu.
- Rotate the **Course control** knob to select the turn angle (setting range: 15° to 360°).
- To start the turn, rotate the **Course control** knob to select [Run] then push the knob.

2.6 FishHunter™ Mode

The FishHunter™ mode is a unique feature of FURUNO NAVpilot series. Find a fish target with your FURUNO sonar/sounder or bird target with your FURUNO radar and feed it to the NAVpilot. The NAVpilot will activate the FishHunter™ mode to perform circle, orbit, spiral, figure eight, square or zigzag maneuvers around the specified target.

Note: This function is not available with a sailboat or Fantum Feedback™.

2.6.1 How to select a FishHunter™ turn and start the turn

- Press the  key to show the turn menu.

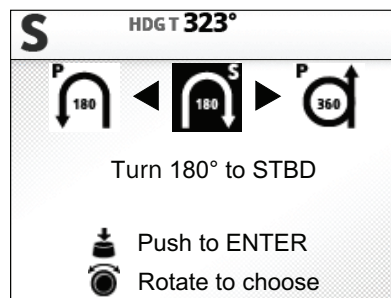

- Rotate the **Course control** knob to select a FishHunter™ turn. The cursor highlights current selection.

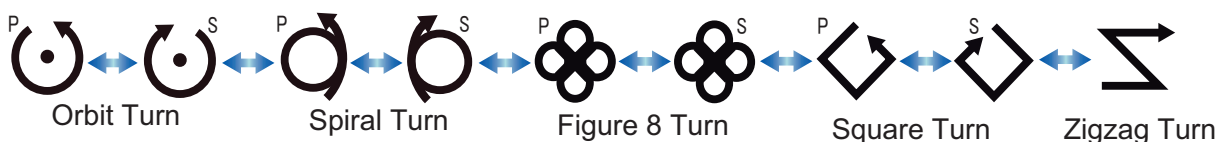
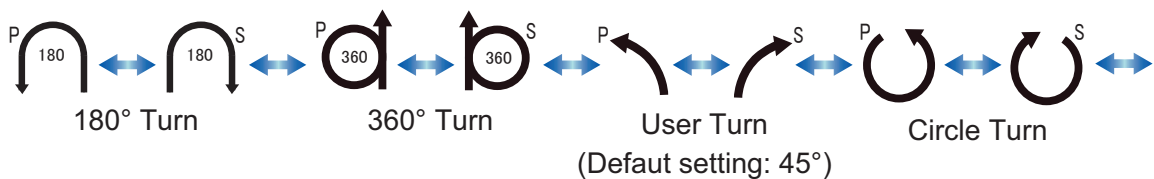

3. If you want to change the parameters for the turn, do 1) - 3) below. If you do not need to change the parameters, go to step 4.
 - 1) Press the  key to show the setting menu for the turn. See section 2.6.3 for details.
 - 2) Rotate the **Course control** knob to select the current setting value for the parameter then push the knob.
 - 3) Rotate the **Course control** knob to set a value then push the knob.
 - 4) Select [Run] then push the knob to start the turn.
4. Push the **Course control** knob to start the turn.
The message "Start to turn by fishing mode" appears, then your boat starts the turn selected.
Note: The orbit and spiral turns require that the speed of the boat be less than 10 kn. If the speed is higher, the message "Too fast to go fishing mode." appears. Reduce boat's speed to less than 10 kn.

During the turn, the ship mark, which indicates own ship's course movement, appears on the turn display. The ship mark does not show accurate ship's movement. To quit the turn, press the  key.

After the turn is completed, the message "Turn ended." appears.

Circle turn

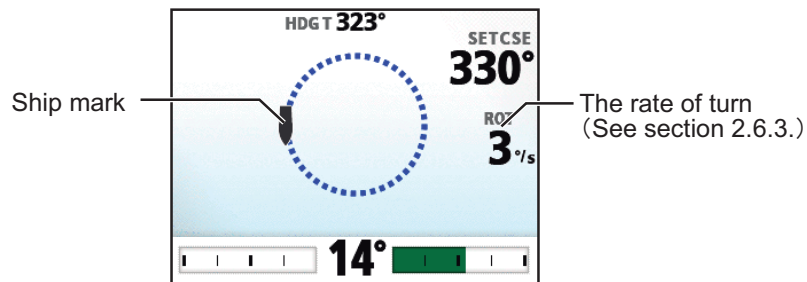

Orbit turn

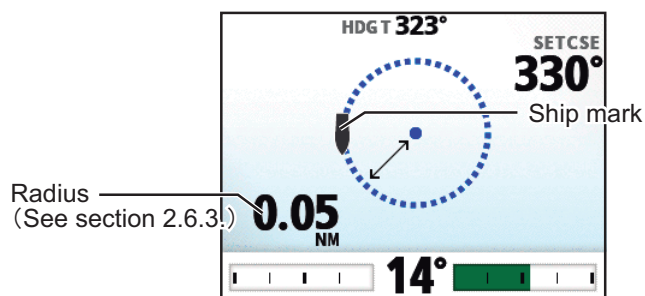

2. STEERING MODES

Spiral turn

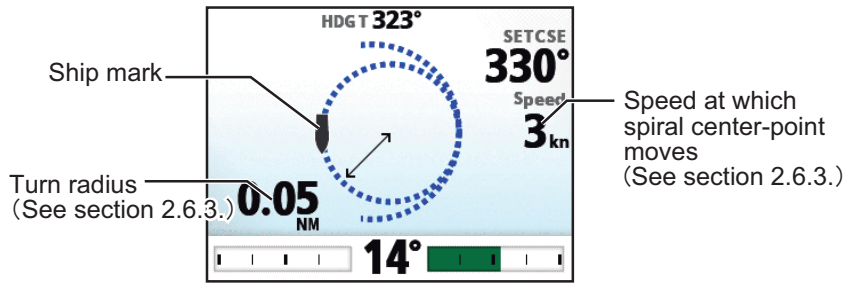

When you select the spiral turn while in the NAV mode or from the TLL menu (see section 2.8), the waypoint name and NAV or TLL icon appears.

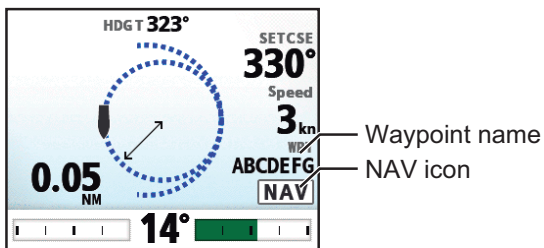

When the turn is selected in the NAV mode

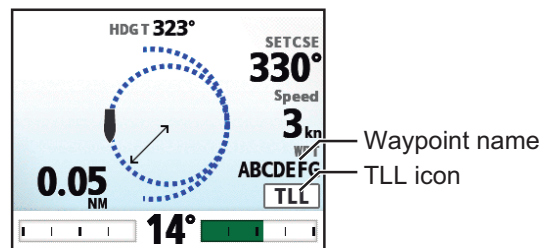

When the turn is selected from the TLL menu

Figure-eight turn

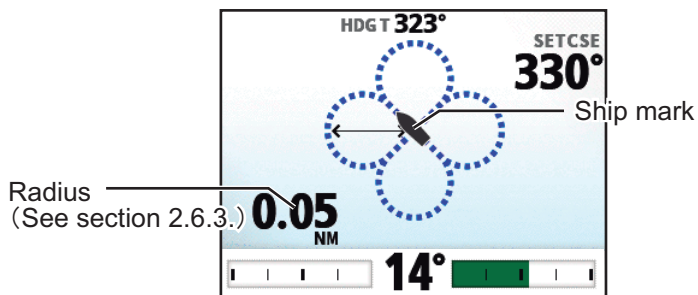

Square turn

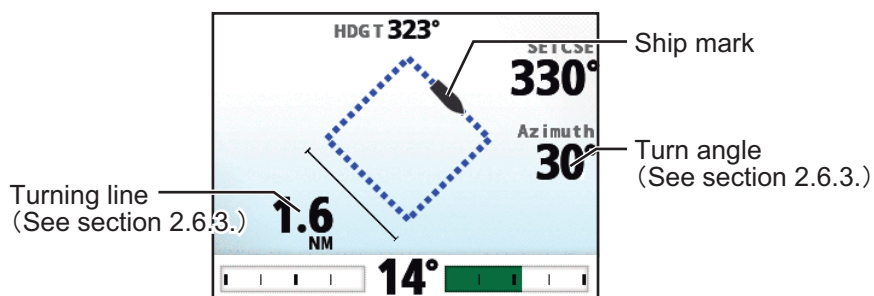

Zigzag turn

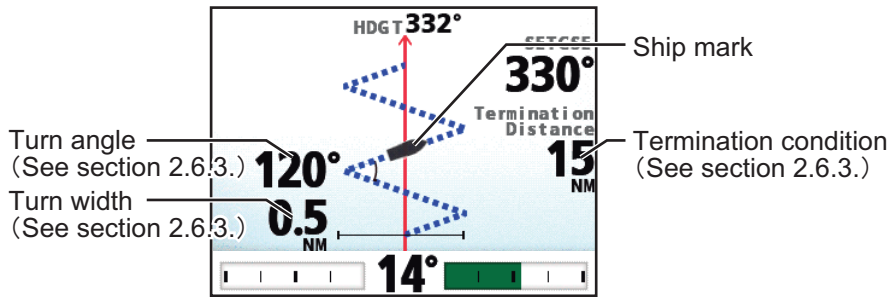

When you select the zigzag turn while in the NAV mode or from the TLL menu (see section 2.8), the waypoint name and NAV or TLL icon appears instead of the termination condition.

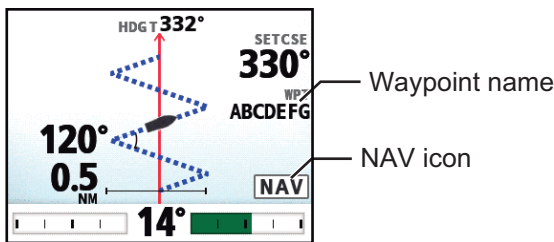

When the turn is selected in the NAV mode

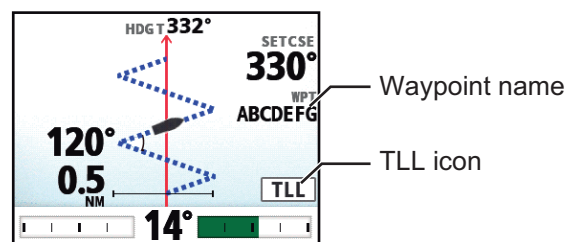

When the turn is selected from the TLL menu

2.6.2 Types of FishHunter™ turns

Circle turn

The circle turn can be used for circling fish or a particular object on the seabed. The rate of turn for the circle can be selected from the menu, but it cannot be higher than that set at installation. This turn can be affected by tide and wind.

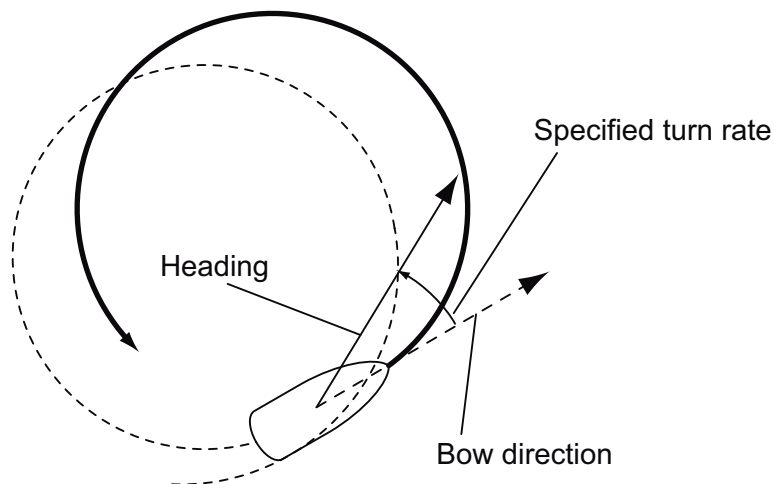

2. STEERING MODES

Orbit turn

In the AUTO mode, your boat orbits around its current position. For the NAV mode, the boat orbits around the (last) waypoint. This function requires a chartplotter or GPS navigator.

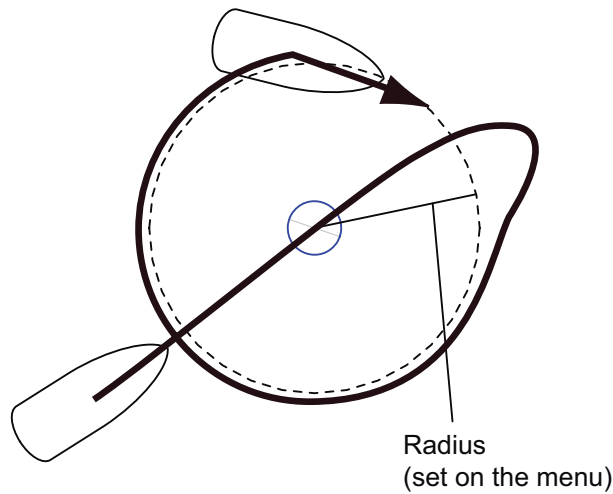

Spiral turn

The boat spirals in the direction of current heading (STBY), set course (AUTO) or the course to the next waypoint (NAV) that was active at the moment that the spiral turn is started.

The boat will continue to spiral until the  or **AUTO** key is pressed.

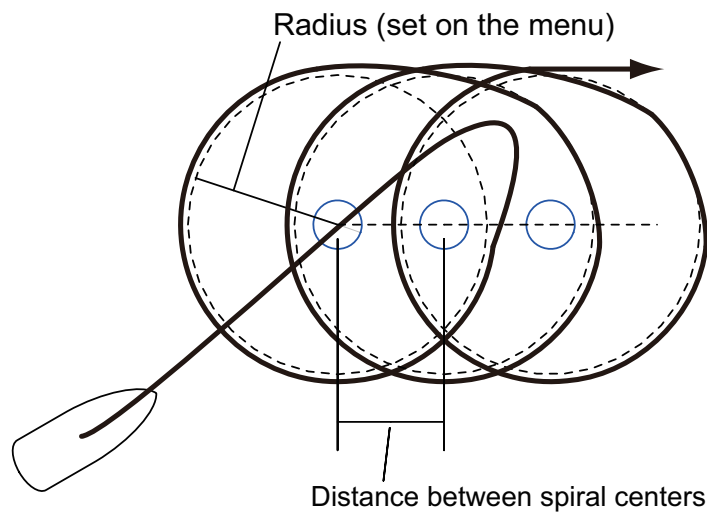

$$\text{Distance between spiral centers (NM)} = \frac{6.28 \times \text{Radius}}{\text{Spiral Speed (set on the menu)}}$$

Note: In the NAV mode, if the boat does not enter the arrival alarm area, the NAVpilot does not switch to the next waypoint. To prevent this, set the arrival alarm range as large as possible and activate the perpendicular function on the chartplotter.

Figure-eight turn

After the boat has traveled the radius set on the menu, it starts turning in a figure-eight pattern, automatically returning to the position where the figure-eight was initiated. The radius is set on the menu.

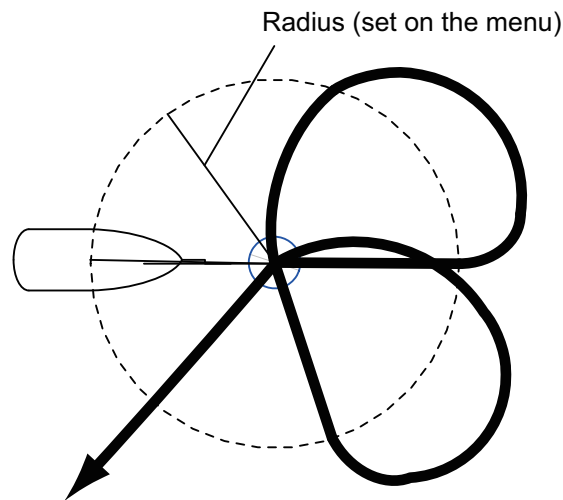
**Square turn**

The square turn is started from a waypoint. You can set length of the sides and the azimuth on the menu.

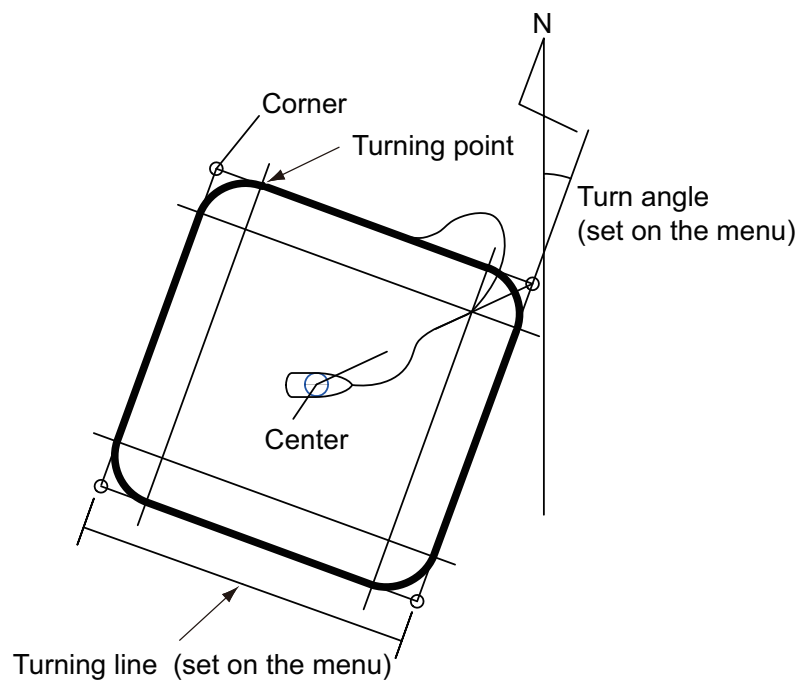

2. STEERING MODES

Zigzag turn

The zigzag turn starts from current position. The distance between legs, turn angle, number of turns and how to stop the zigzag turn can be set on the menu. This turn is available in the AUTO and NAV modes.

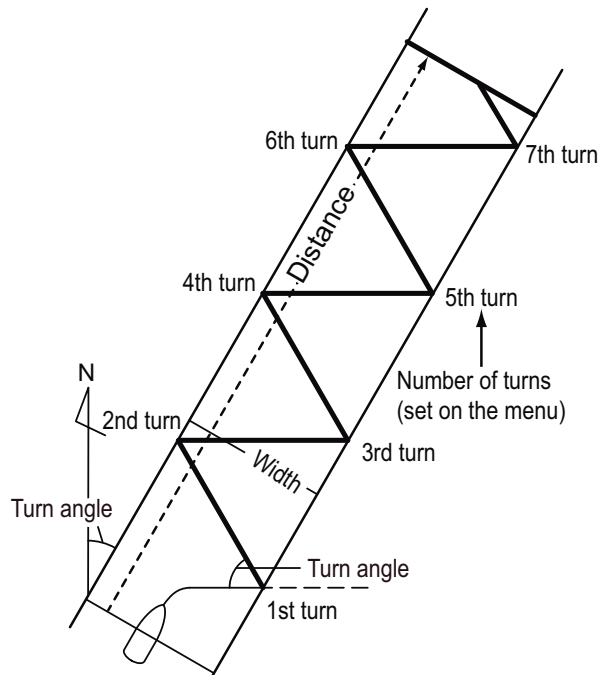

2.6.3 How to set FishHunter™ turn parameters

You can set the parameters for the FishHunter™ turns as follows:

1. Long press the  key to open the menu.
2. Rotate the **Course control** knob to select [Other Menu] then push the knob.
3. Rotate the **Course control** knob to select [Fish Hunter Option] then push the knob.

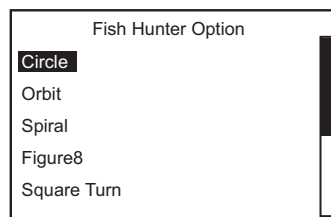

4. Rotate the **Course control** knob to select the turn desired then push the knob. Set the parameters for each turn referring to the figure bellow.

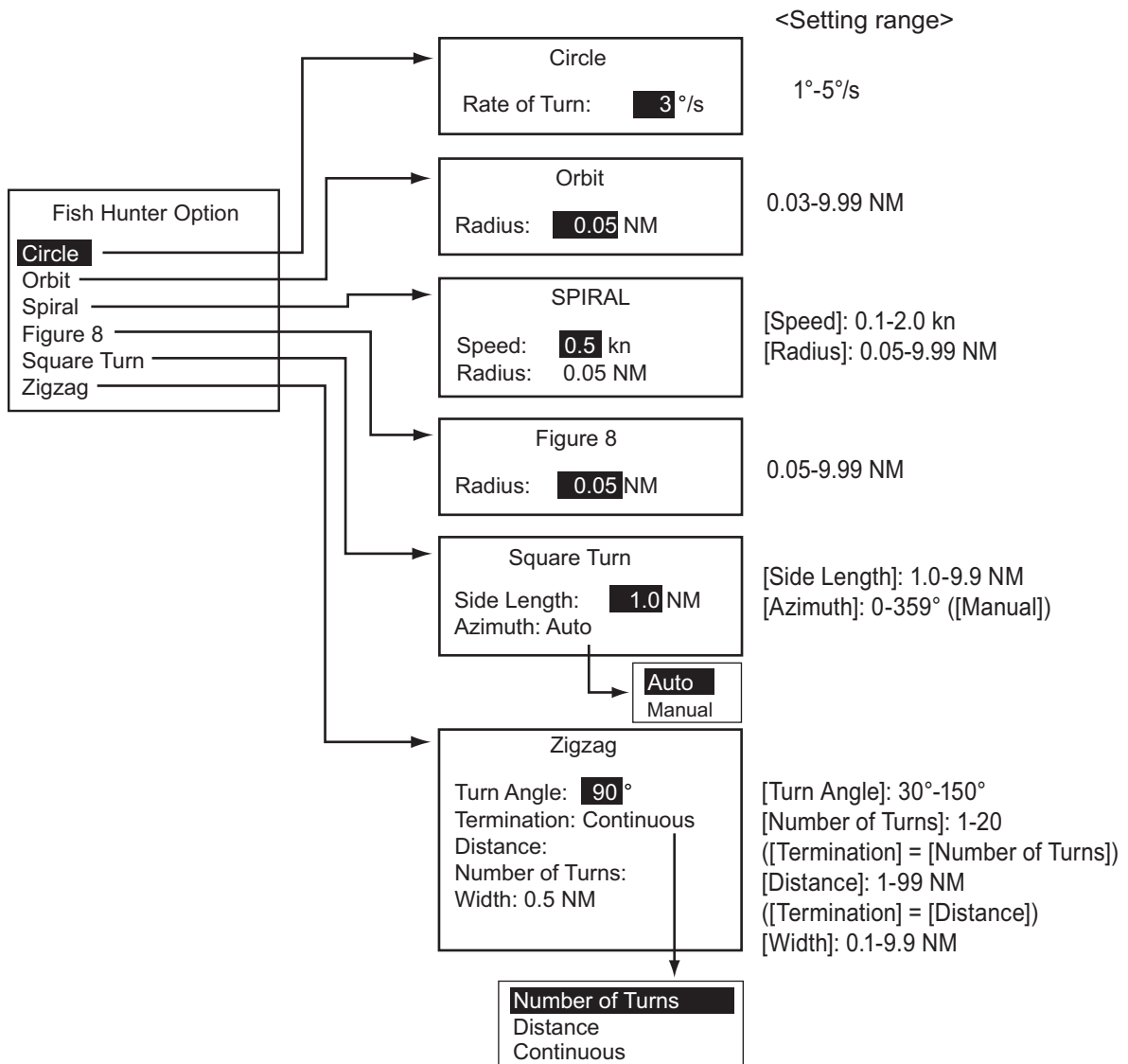

2.7 SABIKI Mode (Outboard Vessels Only)

The SABIKI mode controls the rudder while the vessel is using reverse thrust, effectively keeping the stern facing windward (or into the current) while keeping the bow leeward (or with the current).

Due to the SABIKI mode's ability to control the rudder, only the throttle requires periodic adjustment to keep the vessel facing in the same direction. The reduction of required adjustments allows you to focus more on fishing, even with a light crew on-board.

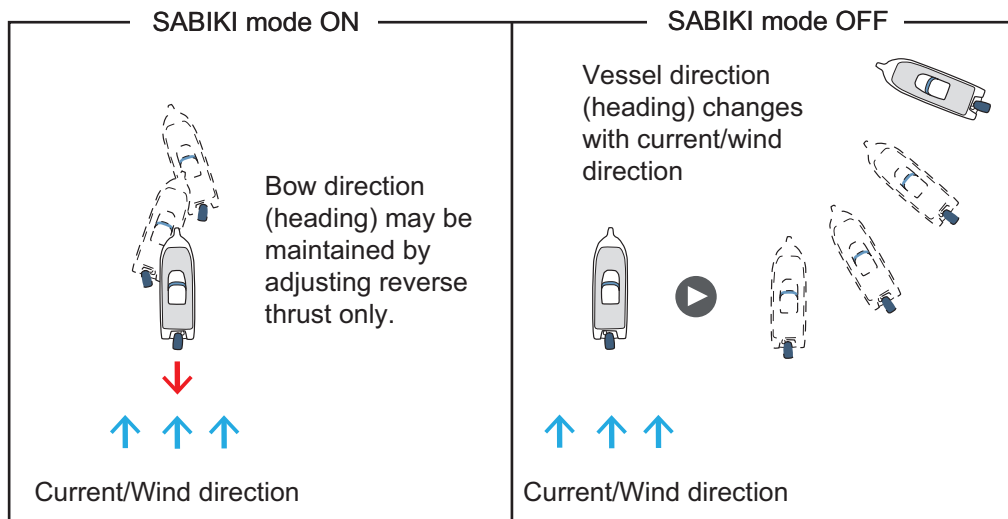

The SABIKI mode is designed for the following vessel types

- Vessels with outboard engines (Up to four engines).
- Vessels with a length of 40 feet or less.

Important notes regarding the SABIKI mode

- The SABIKI mode requires data input from a speed sensor. If [Speed Calculation] is set to [Manual], the SABIKI mode is not available.
- While the SABIKI mode is active, the following functions are disabled:
 - Dodge mode
 - Dodge-type remote control
- When the deviation alarm sounds, immediately change the vessel's direction.
- Where the deviation alarm setting is greater than [45°], during the SABIKI mode the setting is fixed at [45°]. When the SABIKI mode is deactivated, the deviation alarm setting returns to the previous setting.
- The SABIKI mode's performance in keeping the vessel facing the same direction is based on the outboard engine's reverse thrust.
- The SABIKI mode requires speeds of less than 5 knots. Where the vessel exceeds 5 knots, the pop up message "Reduce Speed for SABIKI (<5kn)" appears.
- The SABIKI mode is only available with the FAP-7011C. This mode is not available with the FAP-7001/FAP-7011/FAP-7021.
- To prevent over-steering, ensure the throttle is within reach while the SABIKI mode is active.
- Center the rudder before activating the SABIKI mode with Fantum Feedback™. If the SABIKI mode is activated when the rudder is turned, the autopilot can not control the vessel properly.

2.7.1 How to use the SABIKI mode



Preparations for the SABIKI mode

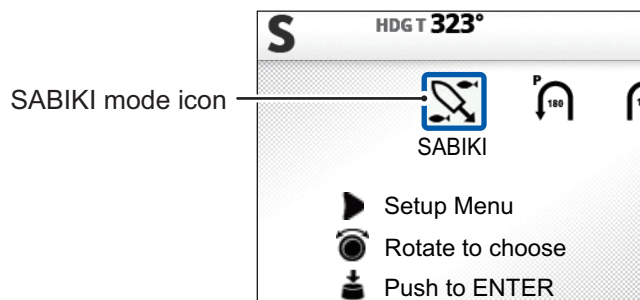

- Check that there is a speed sensor connected to the processing unit. Check that [Speed Calculation] is set to [Auto].
 - In the [Ship's Characteristics] menu, set [Boat Type] to [Planing] or [Semi-Displace].
 - In the [Ship's Characteristics] menu, set [SABIKI Mode] to [ON]. The [SABIKI Mode] option is not available unless the [Boat Type] is set to [Planing] or [Semi-Displace].
1. Reduce the vessel's speed to less than 5 knots.
 2. Orient the vessel with the stern in a windward direction, or into the current, then center the rudder.
 3. Push the  key to show the turn menu.

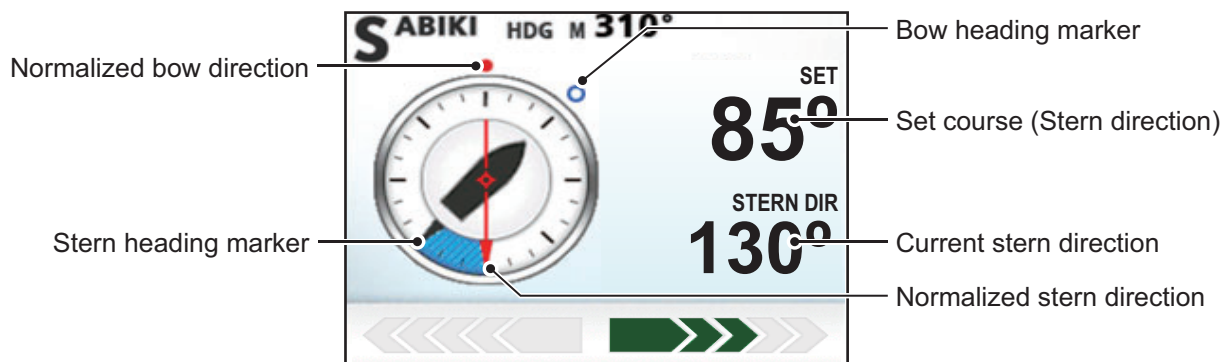

4. Select [SABIKI], then push the **Course control** knob. The SABIKI mode is activated and a screen similar to the one shown below is displayed.





The vessel direction (heading) may be adjusted manually during the SABIKI mode. This is helpful in situations such as wind direction change. There are two methods to change the vessel direction. The arrow keys ( and ) or the **Course control** knob. Use the stern direction as a reference when adjusting course.

- The  key and the  key adjust the heading according to the setting for [Arrow Key] in the [System Setup] menu. When [Arrow] Key is set to [Dodge], heading is adjusted in 10° increments.
- The **Course control** knob adjusts the heading in 1° increments.

When the stern is not facing the wind or current, increase reverse throttle as necessary, to adjust direction. Where this method does not rectify the vessel direction, see section 2.7.2.

2.7.2 How to adjust the SABIKI mode response

When vessel direction adjustment during the SABIKI mode is problematic, use the following procedure to adjust the response level for the SABIKI mode.

1. Push the  key to show the turn menu.
2. Select the SABIKI mode icon, then push the  key. The [SABIKI Option] window is displayed.

Note: The [Rudder Drive Level] menu option is not available when using Fantum Feedback™

The [SABIKI Option] window may also be displayed in the following manners:

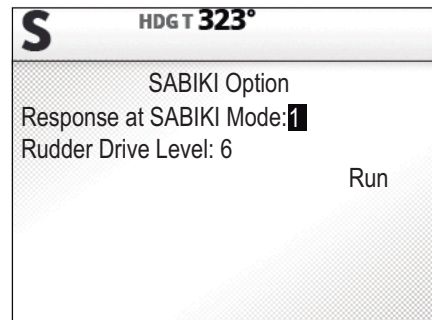

- While the SABIKI mode is active, press and hold the  key.
- From the menu: [Other Menu] → [SABIKI Option].



3. Select the current setting value at [Response at SABIKI Mode], then push the **Course control** knob.
4. Turn the **Course control** knob to adjust the response setting.
 - Where the SABIKI mode over-corrects the direction: Increase the response level. If the direction is over-corrected with this setting, reduce reverse throttle.
 - Where the SABIKI mode under-corrects direction: Reduce the response level. If the direction is under-corrected with this setting, increase reverse throttle.
5. To apply the response settings, push the **Course control** knob.
6. Rotate the **Course control** knob to select [Run], then push the knob.

2.7.3 Rudder drive settings for the SABIKI mode

During the SABIKI mode, it is possible to adjust the rudder drive settings. A high setting gives a larger rudder turn.

1. Push the  key to show the turn menu.
2. Select the SABIKI mode icon, then push the  key. The [SABIKI Option] window is displayed.

The [SABIKI Option] window may also be displayed in the following manners:

- While the SABIKI mode is active, press and hold the  key.
- From the menu: [Other Menu] → [SABIKI Option].

3. Select the current setting value at [Rudder Drive Level], then push the **Course control** knob.

Note: The [Rudder Drive Level] menu option is not available when using Fantum Feedback™.

4. Turn the **Course control** knob to adjust the drive level setting.
5. To apply the response settings, push the **Course control** knob.
6. Rotate the **Course control** knob to select [Run], then push the knob.

2.8 How to Navigate to a TLL Position

The moment TLL (Target Latitude and Longitude) data is input from a radar or echo sounder in the STBY, AUTO or NAV mode, a dialog box appears, where you can select how to progress towards that position. This mode requires position data and waypoint position data.

When the TLL data is input, the TLL menu as shown below appears. Rotate the **Course control** knob to select the turn. You can quit the turn but you can not change the turn mode.

Note: This mode is not available with a sailboat.

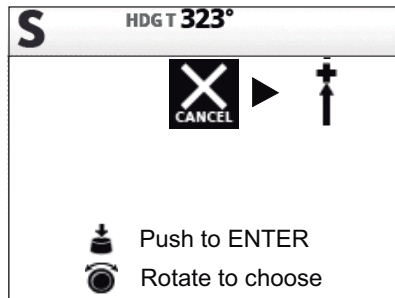

TLL menu

Options on the TLL menu

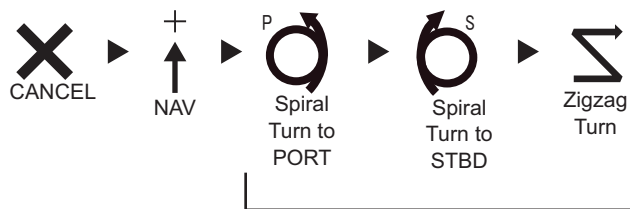

Not shown with Fantum Feedback™.

- **[CANCEL]:** Continues current steering mode.
- **[NAV]:** The boat goes to the TLL by the NAV mode. When [NAV] is selected, the steering mode indication at the top left corner of the display changes as shown right. N^{TLL}
- **[Spiral Turn to PORT (or STBD)]:** The boat goes to the TLL point in a spiral pattern. The waypoint name and TLL icon appear on the turn display.

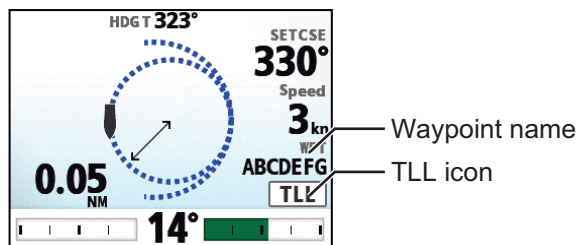

- **[Zigzag Turn]:** The boat follows a zigzag pattern to the TLL. The waypoint name and TLL icon appear on the turn display instead of the termination condition.

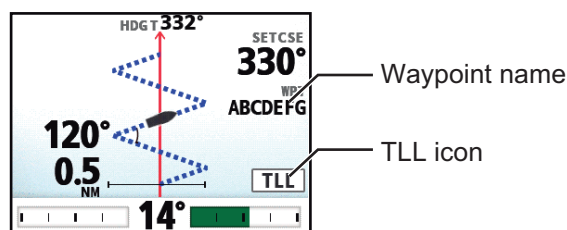

2.9 DODGE Mode

The DODGE mode is useful in situations where you need to quickly take control of the helm to avoid an obstruction.

To use the DODGE mode, set [Arrow Key] to [Dodge] on the [System Setup] menu.

2.9.1 How to dodge in the AUTO and NAV modes

Press the ◀ or ▶ key down to steer appropriately until the boat has cleared the obstruction. The equipment goes into the DODGE mode and the audible alarm sounds when one of the above keys is operated, to alert you to dodge operation. Note also that " **DODGE** " appears at the top left corner of the display. To quit the DODGE mode, release the ◀ or ▶ key.

2.9.2 How to FU dodge in the STBY mode

Press the ◀ or ▶ key simultaneously to steer appropriately until the boat has cleared the obstruction. The equipment goes into the FU mode, and " **FU** " appears at the top left corner of the display. Rotate the **Course control** knob to set the course. To escape from the FU mode, press the ⏻ key.

Note: FU dodge mode is not available with Fantum Feedback™.

2.9.3 How to NFU dodge in the STBY mode

Non-Follow up (NFU) is a manual steering mode that moves the rudder as long as the ◀ or ▶ key is operated. At this time, " **NFU** " appears at the top left corner of the display. To quit the NFU mode, release the key.

2.10 REMOTE Mode

Four types of optional remote controllers can be connected to your NAVpilot to control the NAVpilot from a remote location.

The REMOTE mode is available in the AUTO or NAV mode.

To use the REMOTE mode, select the mode of the remote controllers from the [RC Setup] menu (see section 7.17).

Note 1: Remote controllers are not available with Fantum Feedback™.

Note 2: When the [GENERAL IN] port setting is set to [AP Enable] (see section 7.8.1) and the remote control is turned OFF, the switch connected to the [GENERAL IN] port must be turned ON.

2.10.1 Dial-type remote controller (FAP-5551, FAP-5552)

These are FU-type remote controllers, and they can be used in the AUTO and NAV modes. The rudder moves until operation of the remote controller is stopped.

Note: These models are discontinued after 2017.

To use this function, set the remote mode of the remote controllers to [FU] on the [RC Setup] menu (see section 7.17).

1. Turn the switch on the remote controller to show " **FU-RC** " on the control unit.

Note: When the remote controller switch is turned on, the controls other than the ◀ and ▶ keys are inoperative.

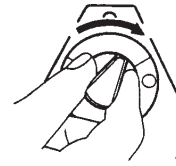

2. Rotate the dial on the remote controller to set the rudder angle.

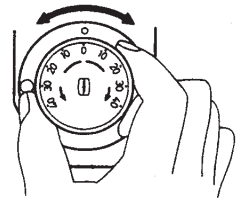

3. To turn off the REMOTE mode, turn off the remote controller.

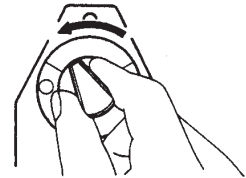

Control is returned to the main control unit and the mode that was previously active (AUTO or NAV) is restored. For the NAV mode, the boat will go to the destination way-point based on the nav steering method menu setting (see section 2.3.2).

2.10.2 Lever-type remote controller (FAP-6221, FAP-6222)

The lever-type controller has an ON/OFF switch and works like an NFU remote controller. When the remote controller is turned on, the user operates the remote controller to move the rudder and the rudder stops once operation of the remote controller is stopped.

To use this function, set the remote mode of the remote controllers to [NFU] on the [RC Setup] menu (see section 7.17).

1. Turn on the remote controller to show " **NFU-RC** " on the control unit.

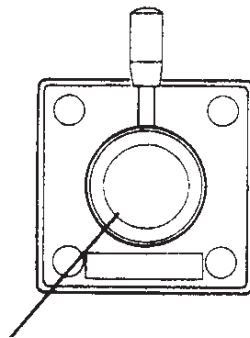

ON: Pull the lever.

Lever-type

2. STEERING MODES

2. Position the lever for the direction.

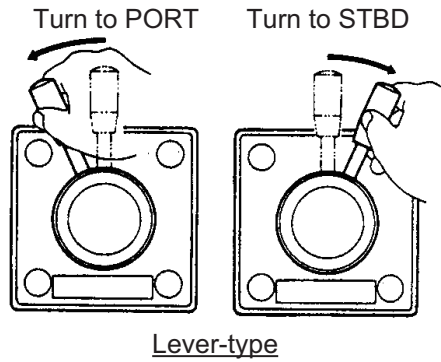

3. Turn off the remote controller to terminate the REMOTE mode.

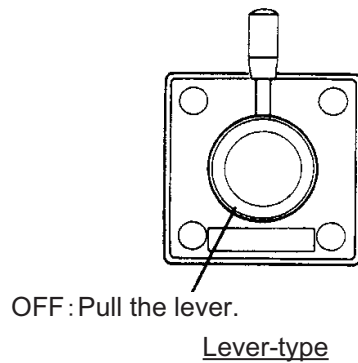

2.10.3 Dodge-type remote controller (FAP-6231, FAP-6232)

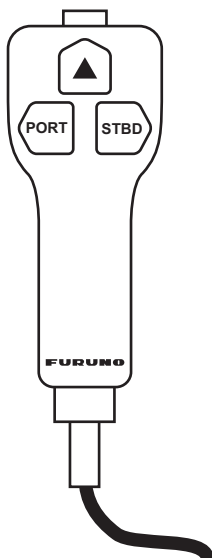

The dodge-type remote controller does not have a power switch. Operate it by simply pressing the direction buttons. The dodge-type remote controller sets your course and rudder is moved to steer the set course.

The dodge-type controller can be used in the AUTO and NAV mode. While you operate the dodge-type controller,

“**DODGE-RC**” appears on the controller unit.

To use this function, set the remote mode of the remote controllers to [Dodge] on the [RC Setup] menu (see section 7.17).

2.11 WIND Mode (for sailboats)



In the WIND mode, the NAVpilot steers the boat based on the wind angle. The NAVpilot consistently maintains the preset angle between ship's heading and wind direction (true or apparent), while eliminating the effects of turbulence and short term wind variations.

To use the WIND mode, set [Boat Type] to [Sailboat] on the [Ship's Characteristics] menu. Also, the wind sensor data is required.

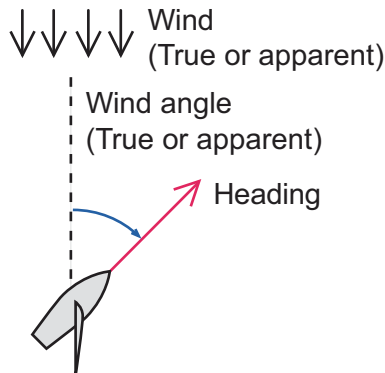
Note: The WIND mode is not available with Fantum Feedback.™



2.11.1 How to get the WIND mode

1. Direct the heading to the desired direction and trim the sail to keep the wind direction, in the STBY mode.
2. Press the **AUTO** key while holding the  key down to activate the WIND mode.
3. Rotate the **Course control** knob to set the wind angle.
4. To escape from the WIND mode, press the  key.

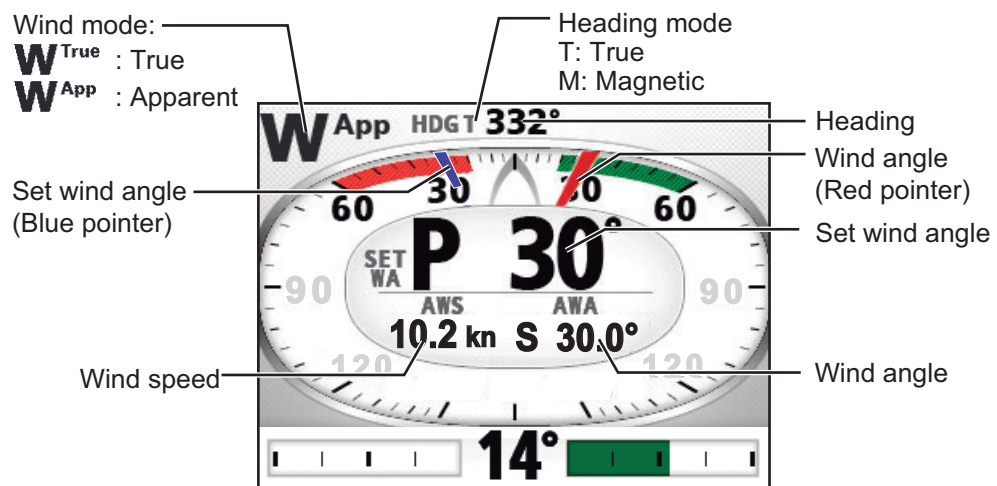

2. STEERING MODES

2.11.2 Wind angle mode

There are two wind angle modes: App (Apparent Wind Angle) and TWA (True Wind Angle).

Wind angle mode	Description	Steering mode indication
App (Apparent Win Angle)	The boat is steered so that the apparent wind angle is constant. AWA mode requires wind angle and speed data from a wind sensor. Use this mode when the wind is stable.	W^{App}
TWA (True Wind Angle)	The boat is steered so that the true wind angle (in relation to ship's bow) is constant. This mode requires apparent wind angle, apparent wind speed, your boat's speed and heading. Use this mode when there is an unstable downwind.	W^{TRUE}

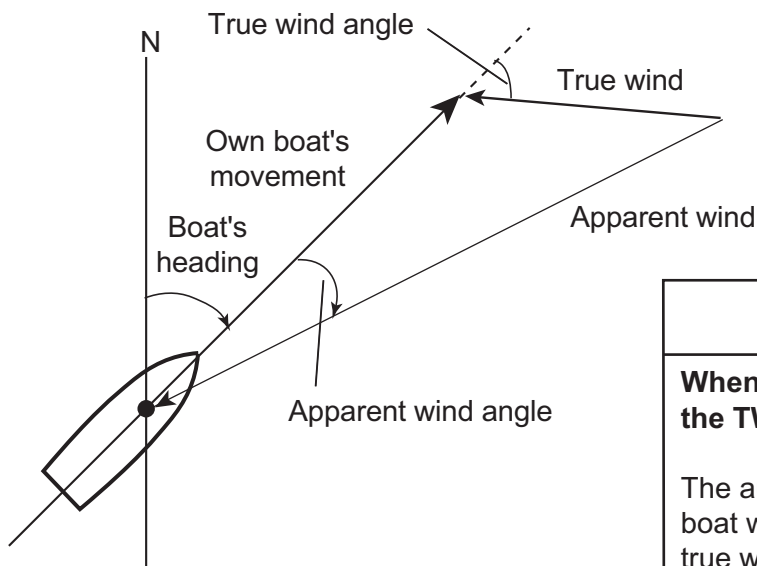

NOTICE

When running on engine, use the TWA mode.

The autopilot cannot control your boat when its speed exceeds the true wind speed in the App mode, which can lead to a potentially dangerous situation.

To select the wind angle mode, do the following:

1. In the Wind mode, long press the  key to open the menu.
2. Rotate the **Course control** knob to select the current setting for [Mode Type] then push the knob.
[Mode Type] also appears on the [Wind Option] menu.



3. Rotate the **Course control** knob to select an option then push the knob.
4. Press the  key to close the menu.

2.11.3 TACK mode

The TACK mode provides various tacking and gybing motions. Fixed and auto tacking are available. Use the tack mode when the true wind angle is less than 90°.

Tacking/gybing (fixed tack)

This function changes the current course by the degrees (set on menu) to port or starboard direction. There are two types of speed, [Slow] (for gybing) and [Fast] (for tacking) in this mode.

To start tacking/gybing, do the following:

1. Press the **AUTO** key to get the AUTO mode.
2. Press the  key to show the turn menu.
The tack angle depends on the value of [Fixed Tack Angle]. For how to set [Fixed Tack Angle], see "How to set the fixed tack angle" on page 2-28).

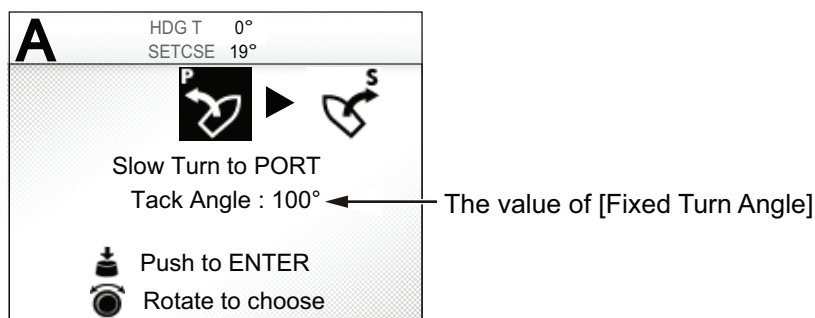

3. Rotate the **Course control** knob to select a turn.

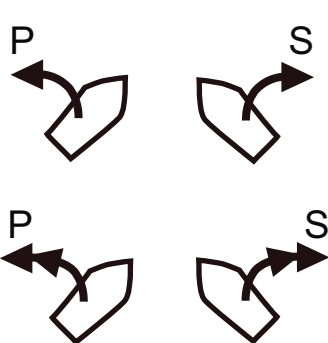

[Slow Turn to Port (STBD)]: For gybing, when the wind angle is larger than 120°. The boat slowly changes the heading angle.

[Fast Turn to Port (STBD)]: For tacking, when the true wind angle is less than 90°. The boat rapidly changes the heading angle.

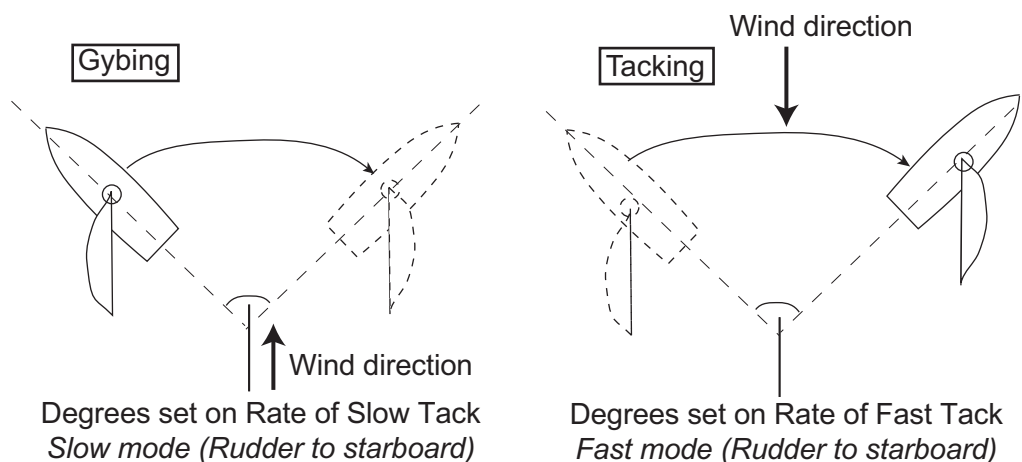

4. Push the **Course control** knob to start the turn.
After you start the turn, the message "Beginning turn" appears, and the alarm sounds three times.

2. STEERING MODES

- While confirming your heading, do jib sheet creasing and trimming operations. Your boat starts turning in the direction selected at step 3. During the turn, the ship mark, which indicates own ship's course movement, appears on the turn display. The ship mark does not show accurate ship's movement.

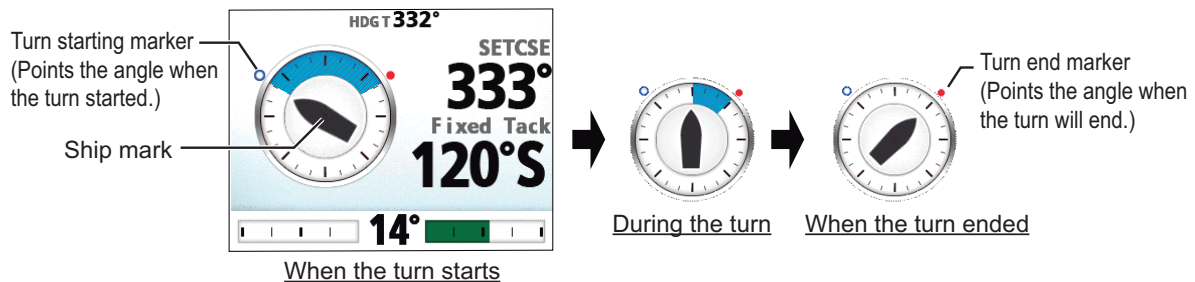



When the turning is completed, a beep sounds three times and the message "Turn ended" appears.

- The tacking angle can be set on the menu. See "How to set the fixed tack angle" on page 2-28.
- The amount of the time to wait before starting a turn after pushing the **Course control** knob can be set on the menu. See "How to set the tack timer" on page 2-31.



How to set the rate of turn for Fast and Slow tacking

The rate of turn is preset as 3° for [Slow Turn to PORT (or STBD)] and 20° for [Fast Turn to PORT (or STBD)]. If you need to change the value, do the following:

- In the WIND mode, long press the  key to open the menu.
- Rotate the **Course control** knob to select the current setting value for [Rate of Slow (Fast) Tack] then push the knob. [Rate of Slow (Fast) Tack] also appears on the [Wind Option] menu.
- Rotate the **Course control** knob to set the rate then push the knob.
- Press the  key to close the menu.

How to set the fixed tack angle

The fixed tacking mode requires the setting of tacking angle. Set the angle as follows:

- In the WIND mode, long press the  key to open the menu.
- Rotate the **Course control** knob to select the current setting value for [Fixed Tack Angle] then push the knob. [Fixed Tack Angle] also appears on the [Wind Option] menu.
- Rotate the **Course control** knob to set the angle then push the knob (setting range: 15°-179°).
- Press the  key to close the menu.

2.11.4 Tacking in WIND mode (WIND TACK)

In the WIND mode, the degree and direction of tacking are automatically set so that the boat receives the apparent wind on its opposite side with the same angle.

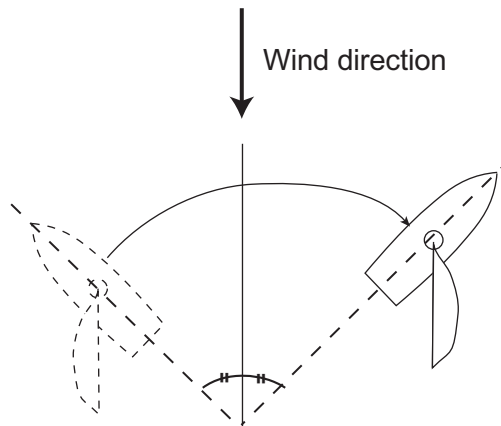

To start turning, do the following:

1. In the WIND mode, press the  key to show the Turn menu.
2. Rotate the **Course control** knob to select the direction to turn. The selections are "Turn to PORT" and "Turn to STBD". If you select an unavailable direction, the message "Wind dir is out of range for your choice" appears and the selection is refused. The turning direction is determined according to the heading at the time the key is pressed, as shown below.

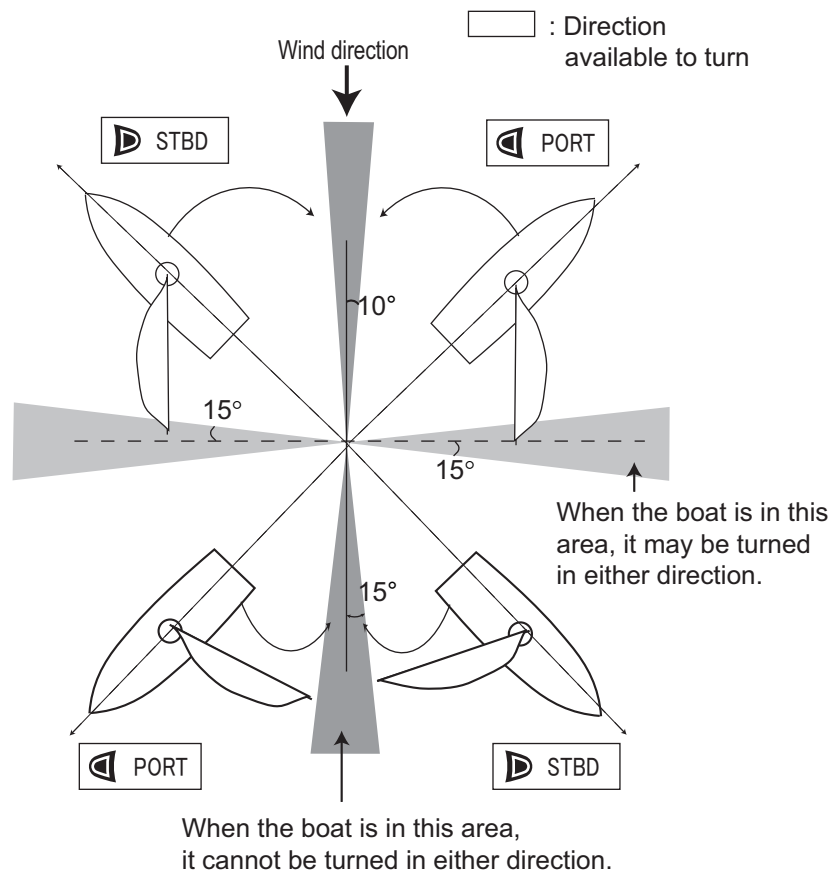

2. STEERING MODES

3. Push the **Course control** knob to start the turn.

The boat starts turning toward the selected direction until the heading changes twice that set when the **Course control** knob was pressed. After you start the turn, the message "Beginning turn" appears, and the alarm sounds three times.

During the turn, the ship mark, which indicates own ship's course movement, appears on the turn display. The ship mark does not show accurate ship's movement.

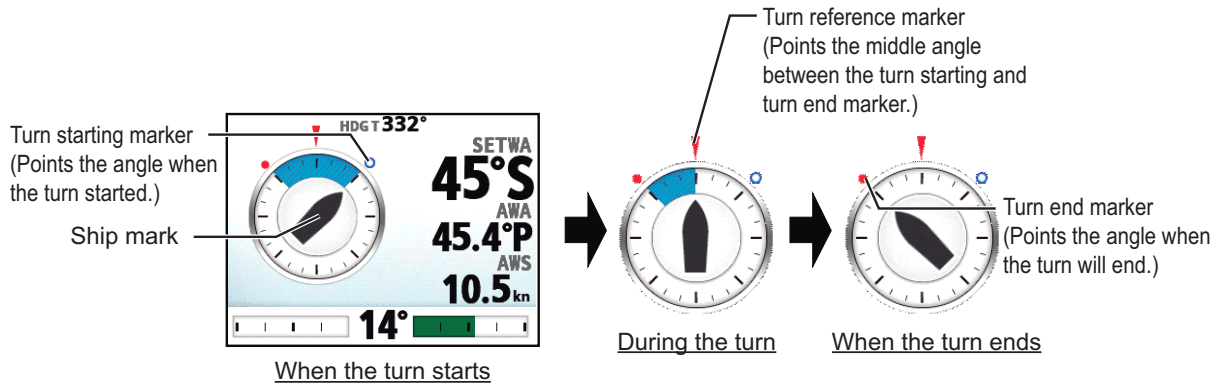



The amount of the time to wait before starting a turn after selecting the turn from the turn menu can be set on the menu. See "How to set the tack timer" on page 2-31.

When the turning is completed, a beep sounds three times and the message "Turn ended" appears.

How to set maximum rudder angle for wind tacking

The tacking in the WIND mode requires the setting of maximum rudder angle. This angle is calculated automatically when the NAVpilot is installed. If you need to change the value, do the following:

1. Long press the  key to open the menu.
2. Rotate the **Course control** knob to select the current setting value for [Wind Track Rud Angle] then push the knob.
[Wind Track Rud Angle] also appears on the [Wind Option] menu.
3. Rotate the **Course control** knob to set the angle then push the knob.
4. Press the  key to three times close the menu.

How to set the damping interval for wind data

You can set the damping interval for wind data to compensate for random fluctuation in wind data. The setting adjusts (damps) the amount of delay between receiving the data and displaying the data. Turn off wind damping if the wind data is received stably.

The port and starboard wind angles must be 55° or higher and the [Mode Type] must be selected to [AWA] (see section 2.11.2) to use this function.

1. Long press the  key to open the menu.
2. Rotate the **Course control** knob to select the current setting for [Wind Damping] then push the knob.
[Wind Damping] also appears on the [Wind Option] menu.
3. Rotate the **Course control** knob to select [ON] then push the knob.

4. Rotate the **Course control** knob to select the current wind damping interval then push the knob.
5. Rotate the **Course control** knob to set the interval then push the knob (setting range: 0.7 - 99 sec.).
See the table below for wind angle and wind damping interval.

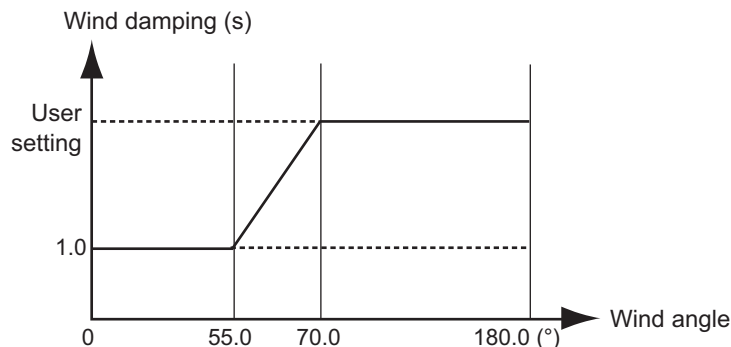



6. Press the  key to close the menu.

How to set the tack timer

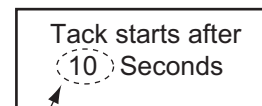

You can set the amount of time to wait before starting a turn (tack time), after selecting the turn from the turn menu. When you enable the tack timer, the countdown window shown right appears after selecting the turn from the turn menu.



Setting value of the tack timer





1. In the WIND mode, long press the  key to open the menu.
2. Rotate the **Course control** knob to select the current setting for [Tack Timer] then push the knob to show the tack timer options.
[Tack Timer] also appears on the [Wind Option] menu.
3. Rotate the **Course control** knob to select [ON] then push the knob.
4. Rotate the **Course control** knob to select the current timer value then push the knob.
5. Rotate the **Course control** knob to set the timer value then push the knob (setting range: 1 - 99 sec.).
6. Press the  key to close the menu.

2.11.5 How to reverse a heading change using the keys/knob

Heading changes may be reversed using the  or  key, or by using the **Course control** knob.

1. In the WIND mode, long press the  key to open the menu.
2. Rotate the **Course control** knob to select [Rotokey Wind Mode] then push the knob.
[Rotokey Wind Mode] also appears on the [Wind Option] menu.

2. STEERING MODES

3. Rotate the **Course control** knob to select the appropriate item, then push the knob.
 - [WA Inc/Dec]: Turn the **Course control** knob clockwise, or press the  key change the wind direction settings in the starboard direction and steer the bow to port. Turn the **Course control** knob counter-clockwise, or press the  key change the wind direction settings in the port direction and steer the bow to starboard.
Note: The  and  keys will not function in Dodge mode.
 - [CRS Change]: Controls are the opposite of [WA Inc/Dec].
4. Press the  key to close the menu.

2.12 OVRD mode (for EVC system)

When the EVC system controls the rudder, the OVRD (override) mode is automatically enabled. The autopilot can not control the vessel in the OVRD mode.

Note: The OVRD mode is enabled for the EVC system equipped vessel only.

OVRD mode activation in the STBY mode

When the OVRD mode activates in the STBY mode, [OVRD] appears at the top-left position of the display. At this time only the [Installation Menu] window and user menus are operative. When the EVC system releases control of the rudder, the autopilot goes to the STBY mode.

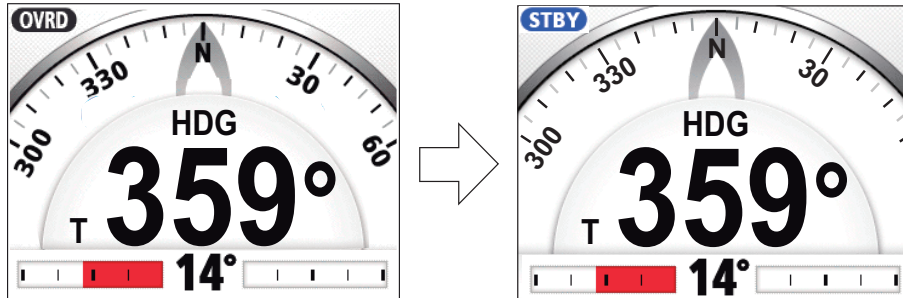

When the EVC system releases control of the rudder.

OVRD mode activation in the AUTO or NAV mode

When the OVRD mode activates in the AUTO or NAV mode, the audio alarm sounds, the message “EVC Override” appears, and the mode indication at the top-left position of the display shows [OVRD]. Press any key to stop the alarm and erase the pop-up. When the EVC system releases control of the rudder, the autopilot goes to the STBY mode.

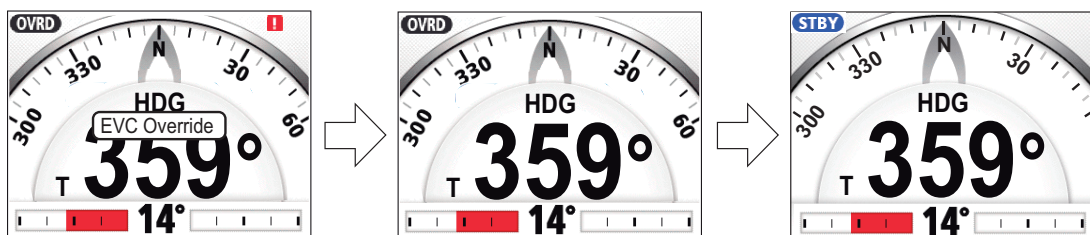

Press any key.

When the EVC system releases control of the rudder.

2.13 Safe Helm Mode

The safe helm mode, available with the Accu-Steer FPS 12V/24V drive unit, temporarily switches the NAVpilot to manual steering for the specified time interval when the helm is steered in an automatic steering mode (AUTO, NAV, etc.). This prevents continued turning of the helm. The mode and course indications flash when the safe helm mode activates.

The safe helm mode is deactivated and the previous automatic steering mode is restored in the following situations:

NAV mode: When the data from helm sensor is not input for the set time on [Return Delay]*.

AUTO, WIND mode, etc. (except NAV mode): When cruising straight ahead and the data from the helm sensor is not input for the set time on [Return Delay]*.

*: See “How to set the safe helm mode” on the next page to set [Return Delay].

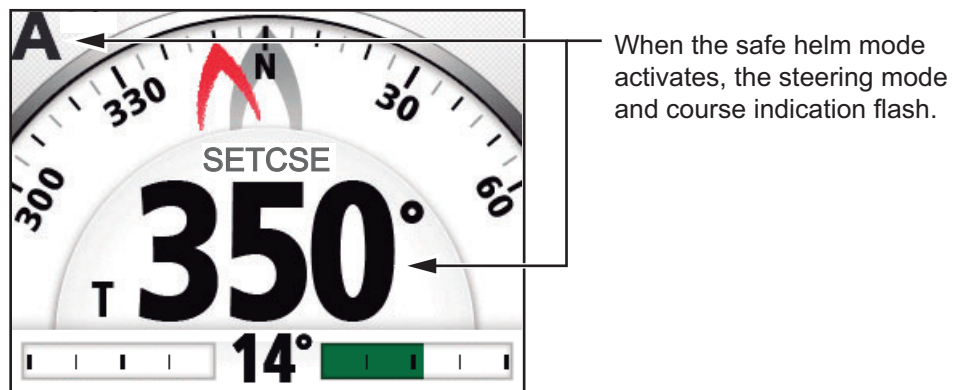

Display example: Safe helm mode in the AUTO mode

How to set the safe helm mode

1. In the STBY mode, long press the  key to open the menu in the STBY mode.
2. Rotate the **Course control** knob to select [Other Menu] then push the knob.
3. Rotate the **Course control** knob to select [Safe Helm/P.Assist Setup] then push the knob.

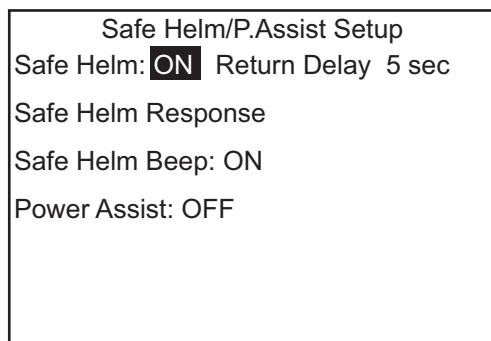



4. Rotate the **Course control** knob to select the current setting for [Safe Helm] then push the knob.
5. Rotate the **Course control** knob to select [ON] then push the knob.
6. Rotate the **Course control** knob to select the current setting value for [Return Delay] then push the knob.

2. STEERING MODES

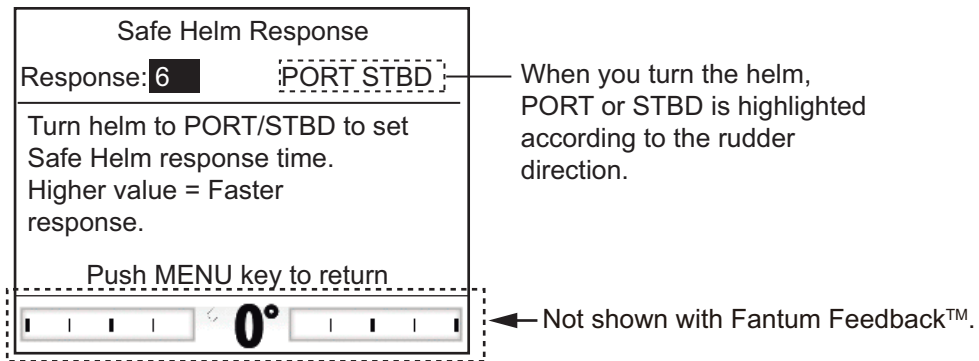
7. Rotate the **Course control** knob to set the return delay then push the knob. The setting range is 1-20 seconds.
 - **NAV mode:** When the data from the helm sensor is not input for the set time, the NAV mode is restored.
 - **AUTO, WIND mode, etc. (except NAV mode):** When cruising straight ahead and the data from the helm sensor is not input for the set time, the previous steering mode is restored.
8. Rotate the **Course control** knob to select [Safe Helm Response] then push the knob.



9. The cursor is selecting the current value for [Response]; push the **Course control** knob.
10. Rotate the **Course control** knob to select a value then push the knob. The higher the setting, the faster the response (setting range: 1-10).
11. Press the  key to close the [Safe Helm Response] window.
12. Rotate the **Course control** knob to select the current setting for [Safe Helm Beep] then push the knob.
13. Rotate the **Course control** knob to select [ON] or [OFF] then push the knob. [Safe Helm Beep] turns the beep on or off when the safe helm mode is activated.
14. Press the  key three times to close the menu.

2.14 Power Assist Mode

The power assist mode, available with the Accu-Steer FPS 12V/24V type drive, customizes manual steering to your own preferences. The mode is available during the safe helm mode and the STBY mode. The indication “” appears at top of the screen when this mode is active.

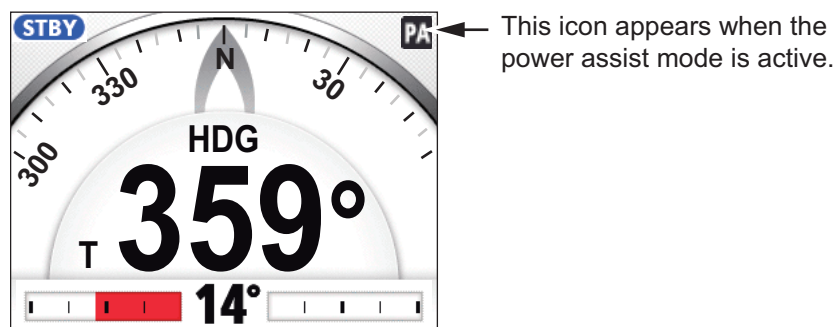

How to set the power assist mode

1. Long press the  key to open the menu in the STBY mode.
2. Rotate the **Course control** knob to select [Other Menu] then push the knob.
3. Rotate the **Course control** knob to select [Safe Helm/P.Assist Setup] then push the knob.
4. Rotate the **Course control** knob to select the current setting for [Power Assist] then push the knob.
5. Rotate the **Course control** knob to select [ON] then push the knob.
When this is done the menu items for the power assist mode appear.

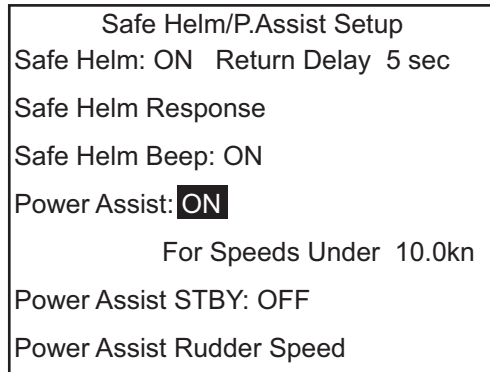

6. Rotate the **Course control** knob to select the current setting value for [For Speeds Under] then push the knob.
7. Rotate the **Course control** knob to set the highest speed at which power assist activates (setting range: 1.0-9.9 kn).
Note: When the power assist activates at high speed, the vessel may turn faster than intended. Set [For Speeds Under] according to the vessel and rudder feature.
8. Rotate the **Course control** knob to select the current setting for [Power Assist STBY] then push the knob.
9. If you want power assist in the STBY mode, select [ON] then push the knob. If not, select [OFF].
10. Rotate the **Course control** knob to select [Power Assist Rudder Speed] then push the knob.

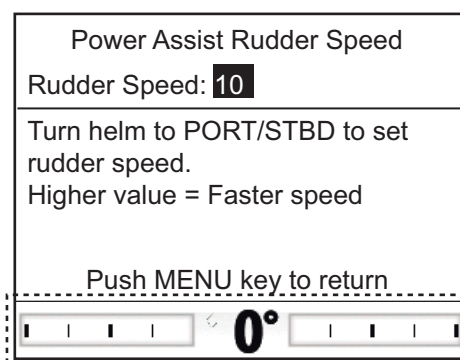

11. The cursor is selecting the current setting value for [Rudder Speed]; push the **Course Control** knob.
12. Rotate the **Course control** knob to select [Rudder Speed] then push the knob.
13. Rotate the **Course control** knob to select a value then push the **Course Control** knob (setting range: 1 to 10).
The higher the setting, the stronger the power assist.

2. STEERING MODES

14. Press the  key three times to close the menu.

How to confirm the rudder steering

Turn the helm to port and starboard and confirm that the power assist activates according to the helm steering. If the power assist only works in one direction, do the helm sensor test (see section 5.3.10.).

Note: Do the confirmation when the ship is docked or cruising at low speed in an area where there are few vessels and obstructions.

3. ALARMS

When an alarm is violated, the buzzer sounds, and the alarm icon () and a pop-up message display appear (see section 5.5.3). If an alarm occurs, change the steering mode to the STBY mode and control the vessel with the helm.

You can see which alarm(s) has been violated by opening [Alarm Log] from the [System Setup] menu. A maximum of 20 alarms are listed on [Alarm Log] (see section 3.13).

3.1 Alarm Menu

All alarm operations are done from the [Alarm] menu. To show the [Alarm] menu, do as follows:

1. Long press the  key to open the menu.
2. Rotate the **Course control** knob to select [Other Menu] then push the knob.
3. Rotate the **Course control** knob to select [Alarm] then push the knob.
The [Alarm] appears on the display.

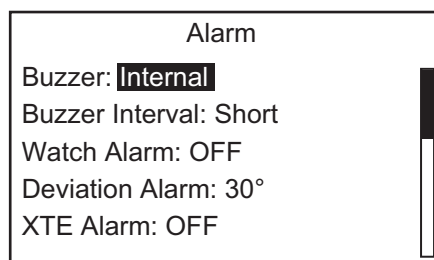

3.2 Alarm Buzzer

You can select the buzzer from which to output the audio alarm as follows. Use the external buzzer if the volume of the internal buzzer is not loud enough.

1. Open the [Alarm] menu.
2. Rotate the **Course control** knob to select the current setting for [Buzzer] then push the knob.
3. Rotate the **Course control** knob to select [Internal] or [Internal+External] then push the knob.
[Internal]: Buzzer in the control unit sounds.
[Internal+External]: Buzzer in the control unit and external buzzer sound.
4. Press the  key three times to close the menu.



3.3 Buzzer Interval

The sound pattern for the alarms can be selected as follows.

Note: For the external buzzer, the buzzer interval pattern can not be changed. The alarm buzzer of the external buzzer sounds continuously when an alarm is violated.

1. Open the [Alarm] menu.
2. Rotate the **Course control** knob to select the current setting for [Buzzer Interval] then push the knob.



3. Rotate the **Course control** knob to select the buzzer interval pattern then push the knob.
 - [Short]: Short alarm buzzer sounds repeatedly.
 - [Long]: Long alarm buzzer sounds repeatedly.
 - [Continuous]: Releases the buzzer continuously.
4. Press the  three times to close the menu.

3.4 Watch Alarm

The watch alarm periodically warns the helmsman to check the NAVpilot when in the AUTO or NAV mode.

1. Open the [Alarm] menu.
2. Rotate the **Course control** knob to select the current setting for [Watch Alarm] then push the knob.
3. Rotate the **Course control** knob to select [OFF] or [ON] then push the knob. For [OFF], go to step 6.
4. Rotate the **Course control** knob to select the current setting value for [Watch Alarm] then push the knob.
5. Rotate the **Course control** knob to set the time interval then push the knob (setting range: 1 to 99 min).
6. Press the  key three times to close the menu.

If the set time passes without operation, the buzzer sounds and the message "The set time has passed" appears. Further, if three minutes elapses after the watch alarm has sounded, the alarm becomes louder. Press any key to stop the alarm.

3.5 Deviation Alarm

The deviation alarm sounds in the AUTO and NAV modes when the heading deviates more than the deviation alarm value.

Note 1: The setting value of the deviation alarm can be changed, but you cannot deactivate this alarm.

Note 2: When the autopilot cannot move the rudder with Fantum Feedback™, the deviation alarm sounds regardless of the setting value. In this case, switch to the STBY mode and turn the helm to move the rudder.

1. Open the [Alarm] menu.
2. Rotate the **Course control** knob to select the current setting value for [Deviation Alarm] then push the knob.
3. Rotate the **Course control** knob to set the degree of deviation then push the knob.
4. Press the  key three times to close the menu.

3.6 XTE Alarm

The XTE alarm, which is available in the NAV mode, alerts you when the course error has exceeded the XTE alarm setting.

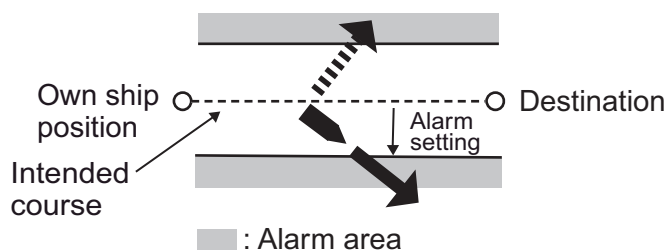

1. Open the [Alarm] menu.
2. Rotate the **Course control** knob to select [XTE Alarm] then push the knob.
3. Rotate the **Course control** knob to select [ON] or [OFF] then push the knob. For [OFF], go to step 6.
4. Rotate the **Course control** knob to select the current XTE alarm value then push the knob.
5. Rotate the **Course control** knob to set the XTE alarm value then push the knob (Setting range: 0.001 - 9.999 NM).
6. Press the  key three times to close the menu.

3.7 Arrival Alarm

The arrival alarm alerts you when you are within a specific distance from a waypoint.

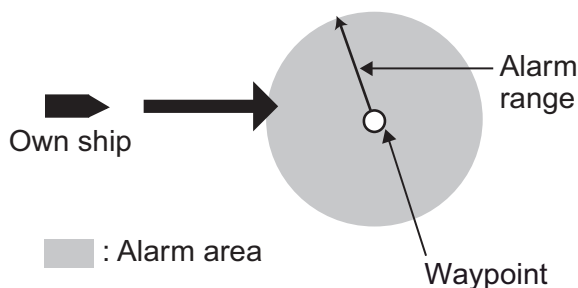

1. Open the [Alarm] menu.

3. ALARMS

2. Rotate the **Course control** knob to select the current setting for [Arrival Alarm] then push the knob.
3. Rotate the **Course control** knob to select [ON] or [OFF] then push the knob. For [OFF], go to step 6.
4. Rotate the **Course control** knob to select the current arrival alarm value then push the knob.
5. Rotate the **Course control** knob to set the arrival alarm value then push the knob (setting range: 0.01 - 9.99 NM).
6. Press the  key three times to close the menu.

3.8 Speed Alarm

The speed alarm warns you when the speed of your boat is within, outside, over or under the speed range setting. Requires speed data.

1. Open the [Alarm] menu.
2. Rotate the **Course control** knob to select the current setting for [Speed Alarm] then push the knob.
The window shown right appears.
3. Rotate the **Course control** knob to select an option then push the knob. For [OFF], go to step 6.]
[OFF]: Turn the alarm off.
[Under]: Alarm sounds when ship's speed is under the set value.
[Over]: Alarm sounds when ship's speed is over the set value.
[Inside]: Alarm sounds when ship's speed is within the speed range set.
[Out of Range]: Alarm sounds when ship's speed is outside the range set.
4. Rotate the **Course control** knob to select the current value then push the knob.
5. Rotate the **Course control** knob to set the value then push the knob.
For [Over] and [Under], set a value.
For [Inside] and [Out of Range], set the upper and lower limits for the alarm.
6. Press the  key three times to close the menu.

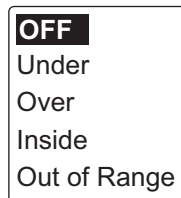

3.9 Depth Alarm

The depth alarm warns you when the bottom is shallower, deeper, within or outside the depth alarm setting. Requires a depth sensor.

1. Open the [Alarm] menu.
2. Rotate the **Course control** knob to select the current setting for [Depth Alarm] then push the knob.
The window shown right appears.
3. Rotate the **Course control** knob to select an option then push the knob. For [OFF], go to step 6.
[OFF]: Turn the alarm off.
[Shallow]: Alarm sounds when depth is less than the set value.
[Deep]: Alarm sounds when depth is greater than the set value.
[Inside]: Alarm sounds when depth is within the depth range set.

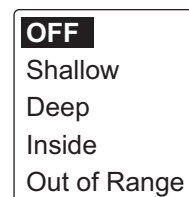

[Out of Range]: Alarm sounds when depth is outside the range set.

4. Rotate the **Course control** knob to select the current setting value.
5. Rotate the **Course control** knob to set the value then push the knob.
For [Shallow] and [Deep], set a value.
For [Inside] and [Out of Range], set the upper and lower limits for the alarm.
6. Press the  key three times to close the menu.

3.10 Water Temperature Alarm

The water temperature alarm warns you when the water temperature is within, outside, over or under the temperature range setting. Also, it is available to alert you when temperature changes over the value set within a minute. Requires a water temperature sensor.

1. Open the [Alarm] menu.
2. Rotate the **Course control** knob to select the current setting for [Temp Alarm] then push the knob.
The window shown right appears.
3. Rotate the **Course control** knob to select an option then push the knob. For [OFF], go to step 6.
[OFF]: Turn the alarm off.
[Under]: Alarm sounds when water temperature is less than the set value.
[Over]: Alarm sounds when water temperature is higher than the set value.
[Inside]: Alarm sounds when water temperature is within the range set.
[Out of Range]: Alarm sounds when water temperature is outside the range set.
[Shear]: Alarm sounds when the temperature changes over the value set within a minute.
4. Rotate the **Course control** knob to select the current setting value then push the knob.
5. Push the **Course control** knob to set the value then push the knob.
[Over], [Under], [Shear]: Set a value.
[Inside], [Out of Range]: Set the upper and lower limits for the alarm.
6. Press the  key three times to close the menu.

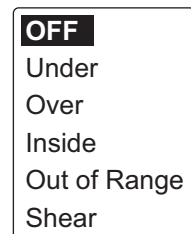

3.11 Trip Distance Alarm, Trip Distance Reset

3.11.1 How to set the trip log alarm

The trip log alarm alerts when you have traveled a specific distance.

1. Open the [Alarm] menu.
2. Rotate the **Course control** knob to select the current setting for [Trip Log] then push the knob.
3. Rotate the **Course control** knob to select [ON] or [OFF] then push the knob. For [OFF], go to step 6.

3. ALARMS

4. Rotate the **Course control** knob to select the current setting value then push the knob.
5. Push the **Course control** knob to set the value then push the knob.
6. Press the  key three times to close the menu.

3.11.2 How to reset the trip distance

Follow the procedure below to reset the trip distance to zero.

1. Open the [Alarm] menu.
2. Rotate the **Course control** knob to select the option for [Clear Trip Log] then push the knob.
3. Rotate the **Course control** knob to select [Yes] then push the knob.
The confirmation message shown below appears.

Clear Trip Log
Are you sure?
Yes: Push ENTER knob
No : Push another key

4. To reset the trip distance, push the **Course control** knob. If you do not want to reset the trip distance, push any key other than the **Course control** knob.
5. Press the  key three times to close the menu.

3.12 Wind Alarms (for sailboats)

The Wind alarm, which is an alarm exclusively for sailboats, has four conditions which generate both audio and visual alarms: heading change, wind deviation, true wind speed and apparent wind speed.

To access the [Wind Alarm] menu, do the following:

1. Long press the  key to open the menu.
2. Rotate the **Course control** knob to select [Other Menu] then push the knob.
3. Rotate the **Course control** knob to select [Alarm] then push the knob.
4. Rotate the **Course control** knob to select [Wind Alarm] then push the knob.
The [Wind Alarm] appears on the display.

Wind Alarm

Heading Change Alarm: **OFF**

Wind Deviation Alarm: 45°

True Wind Spd Alarm: OFF

App. Wind Spd Alarm: OFF

3.12.1 Heading change alarm

The heading change alarm sounds when own boat's heading changes remarkably by the effects of true wind angle. Set the heading value and alarm range as shown in the procedure which follows.

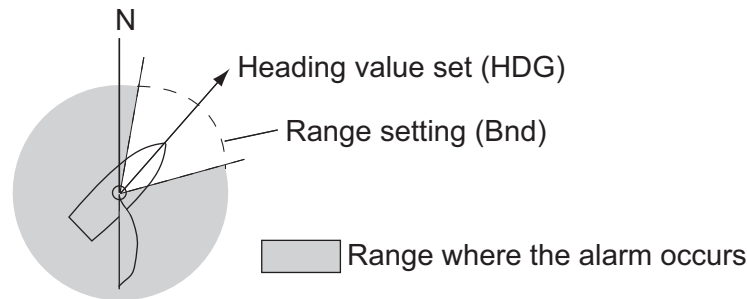

1. Open the [Wind Alarm] menu.
2. Rotate the **Course control** knob to select the current setting for [Heading Change Alarm] then push the knob.
3. Rotate the **Course control** knob to select [ON] then push the knob. The line below [Heading Change Alarm] shows two values ([HDG] and [Bnd]).
4. Rotate the **Course control** knob to select the current setting value for [HDG] then push the knob.
5. Rotate the **Course control** knob to set a value then push the knob.
6. Rotate the **Course control** knob to select the current setting value for [Bnd] then push the knob.
7. Rotate the **Course control** knob to set a value then push the knob.
8. Press the  key four times to close the menu.

3.12.2 Wind deviation alarm

The wind deviation alarm sounds when the current wind angle is greater than the wind angle limit set.

Note: The setting value of the wind deviation alarm can be changed, but you can not deactivate this alarm.

1. Open the [Wind Alarm] menu.
2. Rotate the **Course control** knob to select the current setting value for [Wind Deviation Alarm] then push the knob.
3. Rotate the **Course control** knob to set a value then push the knob.
4. Press the  key four times to close the menu.

3.12.3 True and apparent wind speed alarm

The true or apparent wind speed alarm warns you when the true or apparent wind speed is over or under the true wind speed alarm setting.

1. Open the [Wind Alarm] menu.
2. Rotate the **Course control** knob to select the current setting for [True Wind Spd Alarm] (true) or [Apparent Wind Spd Alarm] (apparent) menu then push the knob.
3. Rotate the **Course control** knob to select [ON] then push the knob.
4. Rotate the **Course control** knob to select the current value then push the knob.
5. Rotate the **Course control** knob to set the upper and lower limits for the alarm then push the knob.
6. Press the  key four times to close the menu.

3.13 Alarm Log

The Alarm Log shows the date, time and alarm no. of violated alarms. A maximum of 20 alarms are listed on the Alarm Log. When the capacity is exceeded, the oldest alarm is deleted to make a room for the latest.

To show this log, do as follows.

1. Long press the  key to open the menu.
2. Rotate the **Course control** knob to select [Other Menu] then push the knob.
3. Rotate the **Course control** knob to select [System Setup] then push the knob.
4. Rotate the **Course control** knob to select [Alarm Log] then push the knob.
The Alarm Log appears on the display.

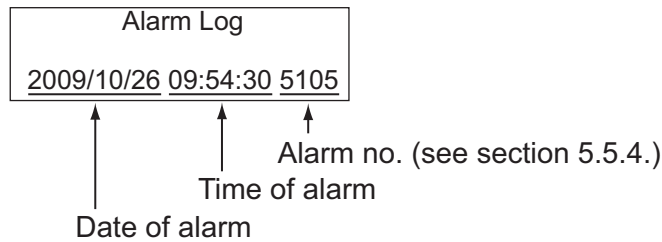

4. USER MENU

This chapter shows you how to customize your NAVpilot to suit the characteristics of your boat and your operational needs. The items shown in each menu depend on the mode in use.

4.1 Parameter Setup

The various parameters for your NAVpilot are set up from the [Parameter Setup] menu. To open the [Parameter Setup] menu, do as follows.

1. In the STBY mode, long press the  key to open the menu.
2. Rotate the **Course control** knob to select [Other Menu] then push the knob.
3. Rotate the **Course control** knob to select [Parameter Setup] then push the knob. The [Parameter Setup] menu appears.

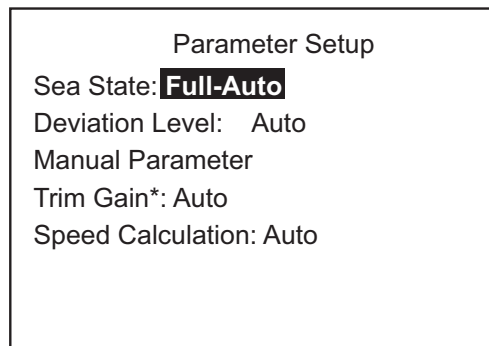

*: Not shown with Fantum Feedback™.

4.1.1 Sea state

How to select NAVpilot steering parameters

Your NAVpilot has two types of steering features for parameter adjustment:

- **Automatic adjustment feature:** Sets up the equipment according to ship's characteristics and sea state, for optimum performance in the AUTO, NAV and WIND modes.
- **Self-learning feature:** Adjusts parameters for rudder ratio, counter rudder and auto trim gains are constantly optimized based on the steering history of your boat, and are stored in memory for future navigation.

1. Open the [Parameter Setup] menu.
2. Rotate the **Course control** knob to select the current setting for [Sea State] then push the knob.

The window shown below appears.

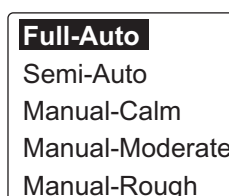



4. USER MENU

3. Rotate the **Course control** knob to select the option which best matches current sea state then push the knob.
[Full-Auto]: Auto adjustment and self-learning are on.
[Semi-Auto]: Auto adjustment is on, self-learning is off.
[Manual-Calm]: Self-learning is off, using the parameter selected for calm sea.
[Manual-Moderate]: Self-learning is off, using the parameters for a typical normal sea state.
[Manual-Rough]: Self-learning is off, using preset parameters for a typical rough sea state.

For normal, everyday operation, the [Full-Auto] mode is recommended. However, if you want the NAVpilot to steer the boat based on experience-related parameters, but you don't want the pilot to be in "self-learning" mode, select the [Semi-Auto].

Note: The course keeping accuracy may be decreased if the sea state is different from the experience-related parameters. This option is provided if you happen to be using the pilot in a situation that you do not anticipate encountering again.

4. For [Full-Auto], set the deviation level as follows. For items other than [Full-Auto], go to step 5.
 - 1) Rotate the **Course control** knob to select the current setting for [Deviation Level] then push the knob. 
 - 2) Rotate the **Course control** knob to select [Auto] or [Level].
For [LEVEL], you may set a value between 1 and 9. A lower number keeps the course more precisely but the rudder may be turned more often. With a higher number, the rudder is fixed, but the course may not be kept as precisely.
5. Press the  key three times to close the menu.

How to manually set NAVpilot steering parameters

When [Manual-Calm], [Manual-Moderate] or [Manual-Rough] is selected as the sea state, set [Manual parameter] as below.

You can set three parameters for the manual function: [Weather], [Rudder Gain] and [Counter Rudder].

1. Open the [Parameter Setup] menu.
2. Rotate the **Course control** knob to select [Manual Parameter] then push the knob.
The display as shown below appears.

Manual Parameter			
	Calm	Moderate	Rough
Weather	1 °	2°	3°
Rudder Gain	3	5	10
Counter Rud.	1	2	4

3. Rotate the **Course control** knob to select the current setting for [Weather]-[Calm] then push the knob.

4. Rotate the **Course control** knob to set value then push the knob (setting range: 0° to 10°).
5. Set [Weather-Moderate], [Weather-Rough] similarly.
6. Set [Rudder Gain] and [Counter Rud.] similarly.
Setting range: 1-20 for [Rudder Gain], and 0-20 for [Counter Rud.]
7. Press the  key four times to close the menu.

Guidelines for how to set [Sea State]

[Weather]: When the sea is rough, the boat's heading fluctuates to port and starboard. If the rudder is driven very often to maintain the set course, the helm mechanism may wear out. To prevent this, the weather adjustment makes the NAVpilot insensitive to minute course deviations. You may choose a degree between 1° to 10°. Until the course deviation exceeds the selected setting, steering to correct the heading will not be initiated.

The illustration at the top of the next page shows boat's track lines with weather setting 3° and 7°. When 7° is set, for example, the rudder is not driven until the course deviation exceeds 7°. Increasing the setting reduces activation of the steering gear, however the boat tends to zigzag. When the sea is calm, set a smaller value.

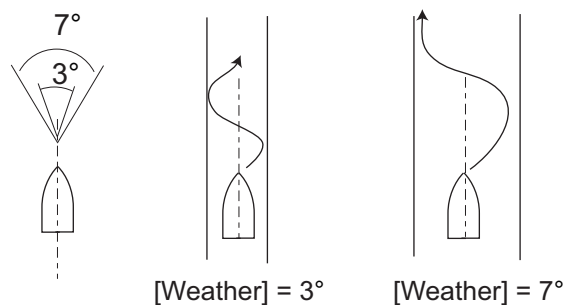

[Rudder Gain]: When the boat's heading deviates from the set course, the NAVpilot adjusts the rudder to correct it. The rudder angle (number of degrees) which is steered against every degree of course deviation is known as the rudder gain.

Set the rudder gain so that the boat does not make frequent yaw. The figure shown below provides general guidelines for setting the rudder gain.

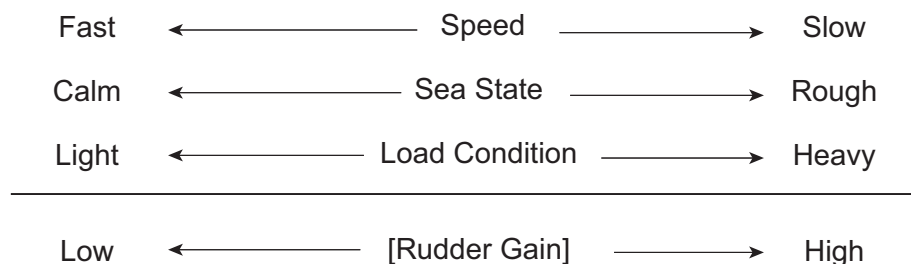

[Counter Rudder]: If the boat is heavily loaded, the heading could change excessively because of inertia. This phenomenon causes the vessel to "overshoot" the intended course. If this happens, the NAVpilot will steer the rudder to the opposite side and the heading will turn in the opposite direction excessively again. In an extreme case the heading oscillates several times until it finally settles in the new course. An adjustment known as "counter rudder" prevents this kind of oscillation.

4. USER MENU

Counter rudder is usually not required for small boats. When your boat zigzags a lot before settling in the new course, increase the counter rudder setting.

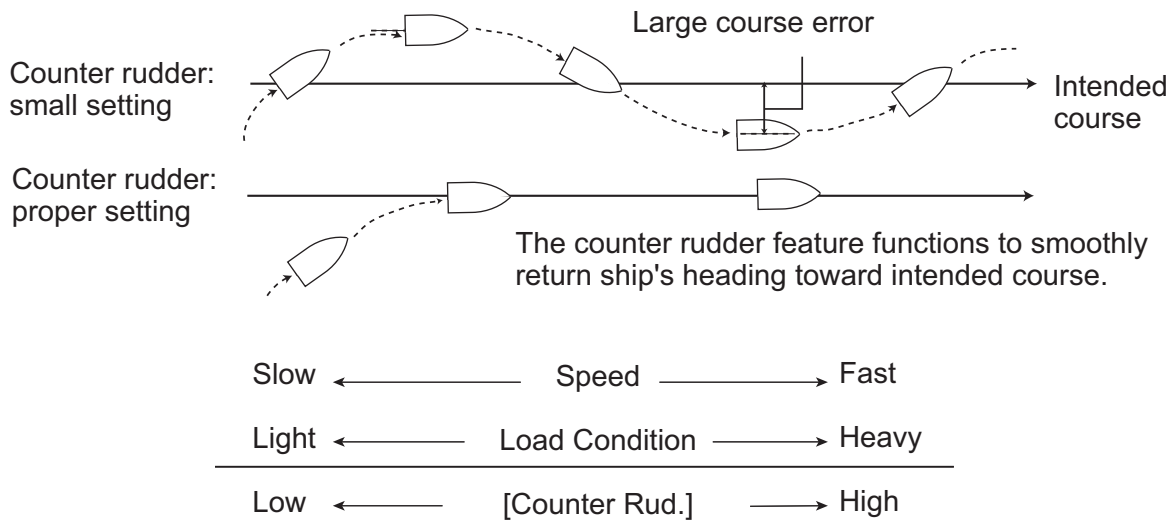

4.1.2 Trim gain

The NAVpilot continually monitors the boat's trim in order to keep the trim sensitivity optimum. A lower setting is common because boat's trim usually does not change quickly. A large number changes the trim compensation value more frequently. Too high of a setting may result in the following problems.

- Trim sensitivity is over-affected, resulting that a trim appears in both port and starboard directions alternately.
- Trim compensation mechanism responds to the yawing, resulting in more serious oscillation of ship's heading.

Note: Trim gain is not available with Fantum Feedback™.

To automatically set the trim, do as follows:

1. Open the [Parameter Setup] menu.
2. Rotate the **Course control** knob to select the current setting for [Trim Gain] then push the knob.
3. Rotate the **Course control** knob to select [Auto] or [Manual] then push the knob.
4. For [Auto] go to step 5. For [Manual], do as follows:
 - 1) Rotate the **Course control** knob to select the current value and push the knob.
 - 2) Rotate the **Course control** knob to set a value then push the knob (setting range: 1 to 20).

The default value is automatically calculated according to length of your boat, entered on the [Ship's Characteristics] menu at installation.
5. Press the  key three times to close the menu.

4.1.3 Speed calculation

Speed is normally entered automatically, from your navigator. If the navigator fails, manually enter speed.

1. Open the [Parameter Setup] menu.
2. Rotate the **Course control** knob to select the current setting for [Speed Calculation] then push the knob.
3. Rotate the **Course control** knob to select [Auto] or [Manual] then push the knob.
4. For [Auto] go to step 5. For [Manual], do as follows:
 - 1) Rotate the **Course control** knob to select the current value then push the knob.
 - 2) Rotate the **Course control** knob to set a value then push the knob (setting range: 0.1 - 99.0).
5. Press the  key three times to close the menu.

4.2 Rudder Drive Level (For Fantum Feedback™)

For Fantum Feedback™, the amount of helm operation required to move the rudder can be adjusted. The higher the setting, the less helm required to move the rudder.

1. Long press the  key to open the menu.
2. Rotate the **Course control** knob to select the current value for [Rudder Drive Level] then push the knob.

Note: When the rudder reference unit is installed, [Rudder Drive Level] does not appear.
3. Rotate the **Course control** knob to set a value then push the knob (setting range: 1 - 20).
4. Press the  key to close the menu.

4.3 Net Towing

When a boat is towing fishing gear its stern is "dragged" by the net. This causes the boat to stray from its intended course. To keep the boat on course, you need to adjust the trim manually, which can be bothersome. If you do not want to be bothered with trim adjustments, you can enable the automatic towing function to have the trim automatically adjusted. This feature is useful for trawlers and purse seiners.

This feature can be assigned to a switch box connected to the GENERAL IN port. For details, see section 7.8.

Note 1: This feature is not available with a sailboat or Fantum Feedback™.

Note 2: Keep the boat on a straight course before enabling the automatic towing function.

1. Long press the  key to open the menu.
2. Rotate the **Course control** knob to select the current setting for [Net Towing AUTO] then push the knob.
[Net Towing AUTO] is also appeared on the [AUTO Option] menu.

4. USER MENU

Note: When [In Port1] or [In Port2] is set for [Net Towing AUTO], [Net Towing AUTO] on the menu is inoperative.

3. Rotate the **Course control** knob to select [OFF] or [ON] then push the knob.
4. Push the  key to close the menu.

4.4 Course After Operation of a Remote Controller

Select the course to follow after a remote controller is operated.

Note: This feature is not available with Fantum Feedback™.

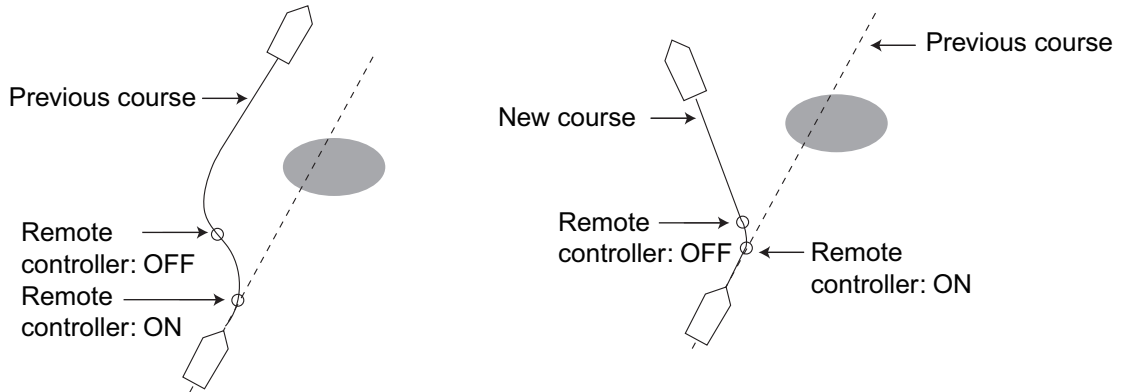

[Cse After Remote] = [Previous Course]

[Cse After Remote] = [Present Course]

1. In the AUTO mode, long press the  key to open the menu.
2. Rotate the **Course control** knob to select the current setting for [Cse After Remote] then push the knob.
[Cse After Remote] also appears on the [AUTO Option] menu.

Previous Course
Present Course

3. Rotate the **Course control** knob to select desired option then push the knob.
[Previous Course]: Keep the course before the operation of a remote controller.
[Present Course]: Keep the course after the operation of a remote controller.
4. Press the  key to close the menu.

4.5 Nav Data Source

Select the source of nav data to use in the NAV mode.

1. In the AUTO mode, long press the  key to open the menu.
2. Rotate the **Course control** knob to select [Nav Data Source] then push the knob.
[Nav Data Source] is also appeared on the [NAV Option] menu.

NAV Data Source
Data Source: **Source1**
Source1: PORT1
Source2: PORT2

3. Rotate the **Course control** knob to select the current setting for [Data Source] then push the knob.

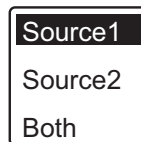

4. Rotate the **Course control** knob to select data source then push the knob. If you have more than one source of nav data, you can select [Both]. In this case, the nav data fed by [Source2] is used when that of [Source1] is not available.

Note: If you have NavNet vx2 equipment connected and it is synchronized with the NAVpilot ([NavNet2] turned on in the [NAV Option] menu, [Source2] is automatically selected (see section 4.6).

5. Rotate the **Course control** knob to select the current setting for [Soutce1] then push the knob.





If you have some equipment which outputs nav data, the name appears in the window. In the example above, a NavNet 3 equipment, with unique ID of 000C2F, is connected.

*: Not shown when [Boat Type] = [EVCS Boat].

6. Rotate the **Course control** knob to select source then push the knob.
7. If you have more than one device that outputs nav data, you can select it at [Source2].
8. Press the  key to close the menu.

4.6 NavNet vx2 Synchronization

The NAVpilot goes to the NAV mode when it receives a P sentence (proprietary FURUNO sentence) from a NavNet vx2 equipment. For example, "autopilot information". You can turn this feature on or off as follows:

1. In the NAV mode, long press the  key to open the menu.
2. Rotate the **Course control** knob to select [NavNet2] then push the knob. [NavNet2] also appears on the [NAV Option] menu.
3. Rotate the **Course control** knob to select [OFF] or [ON] then push the knob.
4. Press the  key to close the menu.

4.7 Data Source Setup

4.7.1 Sensor sync

When NavNet3 or NavNet TZtouch devices are connected to the same network with the NAVpilot, the sensors connected to NavNet3 or NavNet TZtouch devices are available for the NAVpilot. Do as follows to share the sensors:

1. In the STBY mode, long press the  key to open the menu.
2. Select [Other Menu] → [System Setup] → [Sensor Selection] to open the [Sensor Selection] menu.

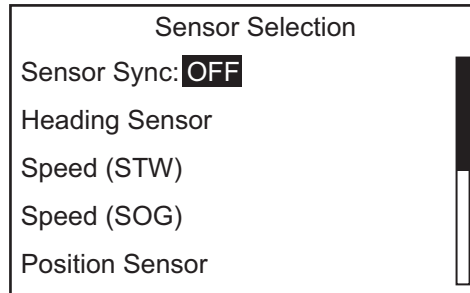

3. The cursor is selecting the current setting for [Sensor Sync]; push the **Course control** knob.
4. Rotate the **Course control** knob to select [ON] or [OFF] then push the knob. When [Sensor Sync] is set to [ON], the sensors connected to NavNet3 or NavNet TZtouch devices are available for the NAVpilot.
5. Press the  key several times to close the menu.

4.7.2 Data source selection

Do as follows to select the data source.

1. Turn on all sensors connected to the NAVpilot.
2. In the STBY mode, long press the  key to open the menu.
3. Select [Other Menu] → [System Setup] → [Sensor Selection] to open the [Sensor Selection] menu.
4. Select the appropriate data to set the data source, then push the **Course control** knob.

The following display example is when [Heading Sensor] is selected.

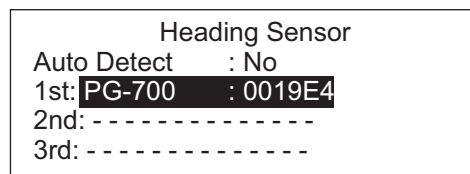

When [Auto Detect] is selected to [Yes], the NAVpilot automatically detects and connects to data sources within the network. In case of multiple heading sensors, the sensors are prioritized in the order of FURUNO CAN bus heading sensor, other CAN bus heading sensor, NMEA0183 heading sensor. After detecting sensors, [Auto Detect] changes to [No] from [Yes]. If desired, you can change the data source priority as follows:

- 1) Rotate the **Course control** knob to select the number then push the knob.



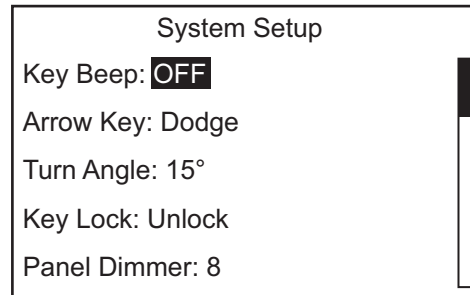

- 2) Rotate the **Course control** knob to select a sensor then push the knob.
5. Press the  key several times to close the menu.

4.8 System Setup Menu

The [System Setup] menu provides various functions which once set do not require frequent adjustment. Set the items in this menu according to operational needs, current environment, etc. To open this menu, open the menu and select [Other Menu] followed by [System Setup].



[System Setup] menu description

Item	Description
[Key Beep]	Turn the key beep on or off. [ON]: The key beep sounds, [OFF]: No key beep
[Arrow Key]	Set the function of arrow keys when pressed to dodge an obstruction in the AUTO and WIND modes. [Dodge], [5°], [10°], [Manual]. For [Manual], select degree of turn from 1°-90°.
[Turn Angle]	Set the angle of User turn in the turn mode. Setting range: 15°-360°, 15° steps
[Key Lock]	<p>Activate or deactivate the key lock of the control unit.</p> <ul style="list-style-type: none"> [Lock]: Keys are locked. When any key other than  key of the locked control unit is pressed the message shown below appears. Also, the lock icon () appears when [Lock] is selected. <p>To unlock, press the  key while holding down the  key. If the locked the control unit is powered off, the next time the control unit is powered, the keys of the control unit are locked.</p> <ul style="list-style-type: none"> [UNLOCK]: Keys are not locked. <div style="border: 1px solid black; padding: 5px; width: fit-content;"> <p>This controller is locked. To unlock, Hold MENU key down and push > key.</p> </div>
[Panel Dimmer]	Set the backlighting level for the panel dimmer (setting range: 1-8).
[Password]*	Assign a four-digit password to use to unlock the keys and menu on the control unit (setting range: 0000-9999).
[Password Function]*	Activates or deactivates password requirement. Select [ON] to require a password to access menus. If the password is entered correctly, the menu becomes operative and the option setting for this item changes to [OFF].
[Save User Setting]	Save current settings as user default settings. Select [Yes] or [No].
[Load User Setting]	Load user default settings. The equipment is automatically restarted to restore saved user settings. Select [Yes] or [No].
[Save Display Setting]	Save all display-related settings. Select [Yes] or [No].
[Load Display Setting]	Load currently saved display-related settings. Select [Yes] or [No].

4. USER MENU

Item	Description
[Alarm Log]	You can see which alarm(s) has(have) been violated. A maximum of 20 alarms are listed (see section 3.13.). When the capacity is exceeded, the oldest alarm is deleted to make a room for the latest.
[Sim/Demo]	Activate or deactivate the demonstration mode. DO NOT use this function on board your boat; it is intended for use by service technicians. [OFF]: Deactivate the demonstration mode. [Demo Slide Show]: Shows the slide show to demonstrate the NAVpilot. [Simulator]: The NAVpilot can be operative by the preset simulation data. [Sim W/Drive]: The NAVpilot can be operative same as simulation mode, but the data for rudder information is required to input.
[Diagnostic]	Perform various diagnostics on the NAVpilot system. See section 5.3. Available in the STBY mode only.
[Display Data Select Menu]	Set and select the data to show in each steering mode. See section 1.5.3 for the procedure.
[Sensor Selection]	Select the data source. See section 4.7.
[System Data]	Show system data. See section 5.4.

*: The [Password] and the [Password Function] are not available when the version of the control unit is as below.



- NAVpilot-711C: Ver.01.11 or later.

4.9 Menu Shortcuts

You can create menu shortcuts to the STBY mode menu for menu items which you often use. Up to 20 shortcuts can be created.

4.9.1 How to create a menu shortcut

The procedure below shows you how to create a menu shortcut for the arrival alarm.

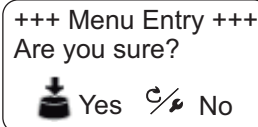

1. Press the  key to go to the STBY mode.
2. Long press the  key to open the menu.
3. Select the menu item for which you want to create a menu shortcut.
For example, select [Arrival Alarm] from the [Alarm] menu.
4. Long press the  key to show the following prompt.

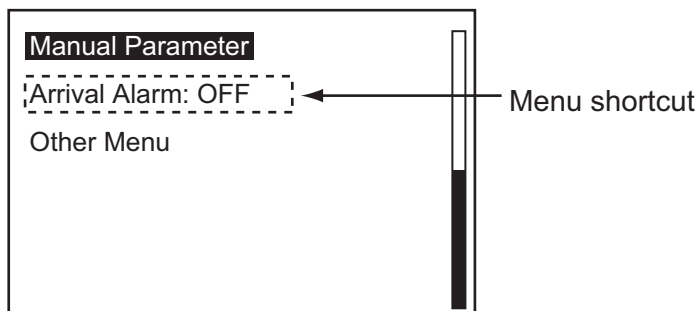

5. Push the **Course control** knob to create the shortcut. The shortcut is then added to the STBY mode menu.



4.9.2 How to delete a menu shortcut

1. Press the  key to go to the STBY mode.
2. Long press the  key to open the menu.
3. Rotate the **Course control** knob to select the menu item to delete.
4. Long press the  key to show the following message.

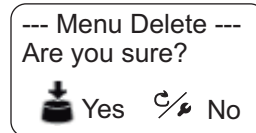

5. Push the **Course control** knob to delete the shortcut.

4. USER MENU

This page is intentionally left blank.

5. MAINTENANCE, TROUBLE-SHOOTING

⚠ WARNING

ELECTRICAL SHOCK HAZARD
Do not open the equipment.

 This equipment uses high voltage that can cause electrical shock. Only qualified persons can work inside the equipment.

NOTICE

Do not apply paint, anti-corrosive sealant or contact spray to plastic parts or equipment coating.

Those items contain products that can damage plastic parts and equipment coating.

5.1 Preventive Maintenance

Regular maintenance is necessary for best performance. Create a maintenance schedule which includes the items shown below.

Item	Check point	Remedy
Control unit connectors	Check for tight connection.	Tighten loosened connectors.
Ground terminal	Check for tight connection and corrosion	Clean or replace the ground wire as necessary.
Cabinet	Dust on the cabinet	Remove dust with a dry clean cloth. Do not use commercial cleaners to clean the equipment. Those cleaners can remove paint and markings.
LCD	Dust on the LCD dims picture.	Clean the LCD carefully to prevent damage, with tissue paper and an LCD cleaner. To remove dirt or salt deposits, use an LCD cleaner and wipe slowly with lens paper so as to dissolve the dirt or salt. Change the paper frequently so the salt or dirt will not damage the LCD. Do not use solvents like thinner, acetone or benzene for cleaning.

5.2 Replacement of Fuse

Two fuses (125V 4A) in the processor unit protect the equipment from reverse polarity of the ship's mains and equipment fault. If a fuse blows, you cannot turn on the power. Have a qualified technician check the set.

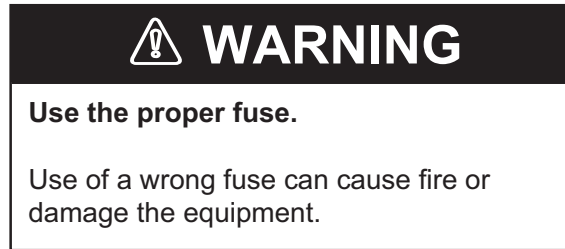

Parts name	Type	Code no.	Remarks
Fuse	FGMB 125V 4A PBF	000-157-482-10	Supplied as spare parts

5.3 Diagnostics

The tests on the diagnostic menu check if your NAVpilot works properly. The tests are for use by service technicians, but you can do the tests to help the technician in troubleshooting.

If NG appears, repeat the test. If the error condition continues, contact your dealer.

5.3.1 Diagnostic menu

1. In the STBY mode, long press the  key to open the menu.
2. Rotate the **Course control** knob to select [Other Menu] then push the knob.
3. Rotate the **Course control** knob to select [System Setup] then push the knob.
4. Rotate the **Course control** knob to select the current setting for [Diagnostic] then push the knob.
The diagnostic test options window appears.

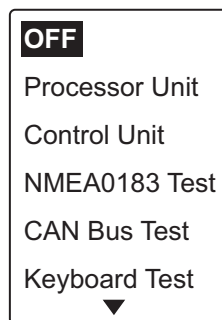

Note: The test options change according to the setting of NAVpilot.

5.3.2 Processor unit test

This test checks the processor unit for correct operation. Open the diagnostic test options window, select [Processor Unit] then push the **Course control** knob.

Processor Unit	ID: 39768
ROM: OK	6454007-**. **
	6454009-**. **
RAM: OK	Backup: OK
Rudder Angle: OK	0°
Bypass/Clutch:	0.7A
RC1/RC2:	OFF -1° /OFF -2°
Input Voltage:	24.5 V
Port1/Port2/CAN:	- /- /OK
CAN ID: 39713	CPU/PWR: */*

*: Version no.
**. **: Program version no.

To close the test result, press the  key.

Test result items of the processor unit test

- [Processor Unit ID]: NMEA2000 Unique ID
- [ROM]: ROM test result ("OK" or "NG"), program number
- [RAM]: RAM test result ("OK" or "NG")
- [Backup]: Backup data test result ("OK" or "NG")
- [Rudder Angle]: The test result of rudder reference unit ("OK" or "NG"). For Fantum Feedback™, "Fantum Feedback" is displayed. Not shown when [Boat Type] is set to [EVCS Boat].
- [Bypass/Clutch]: Presence or absence of bypass/clutch and bypass/clutch amperage. "Not Present" shown in case of no connection. Not shown when [Boat Type] is set to [EVCS Boat].
- [RC1/RC2]: Remote controller state (ON or OFF) and rudder signal input value. Not shown with Fantum Feedback™.
- [INPUT VOLTAGE]: Source voltage
- [Port1/Port2/CAN]: I/O test for NMEA0183 and CAN bus ("OK" or "NG").
- [CAN ID]: Control unit port ID
- [CPU/PWR]: CPU and PWR board version number

5.3.3 Control unit test

This test checks the control unit for correct operation. Open the diagnostic test options window, select [Control Unit] then push the **Course control** knob.

Control Unit	
ROM: OK	6454011-**. **
	6454010-**. **
RAM: OK	Backup: OK
Communication:	OK
Controller ID:	2
CAN ID: 0	CPU:*

*: Version no.
**. **: Program version no.

To close the test result, press the  key.

Test result items of the control unit test

- [ROM]: ROM test result ("OK" or "NG"), program number
- [RAM]: RAM test result ("OK" or "NG")
- [Backup]: Backup data test result ("OK" or "NG")
- [Communication]: Communication state between the processor unit and control unit ("OK" or "NG")
- [Controller ID]: ID of the control unit
- [CAN ID]: ID of CAN bus equipment
- [CPU]: CPU board version number

5.3.4 EVC interface test

This test confirms the program version no. of the IPS interface unit (IF-700IPS) or NMEA data converter (IF-NMEA2K2).

Open the diagnostic test options window, select [Processor Unit] then push the **Course control** knob. This test is available when [Boat Type] is set to [EVCS Boat].

```
EVC Interface
ROM: OK 6454018*-.**.**
        6454019*-.**.**
RAM: OK
```

*: Program no. for IF-700IPS. In case of IF-NMEA2K2, the following program no. appears.
1451436_**.**
1451437_**.**
:: Program version no.

To close the test result, press the  key.

Test result items of the EVC interface test

- [ROM]: ROM test result ("OK" or "NG"), program number
- [RAM]: RAM test result ("OK" or "NG")

5.3.5 NMEA0183 test

This test checks for correct input and output of NMEA 0183 data from PORT1 and PORT2. Open the diagnostic test options window, select [NMEA0183 TEST] then push the **Course control** knob.

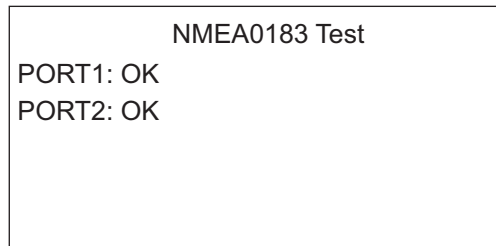

To close the test result, press the  key.

Test result items of the NMEA0183 test

- [PORT1]/[PORT2]: Test result of the communication with NMEA0183 equipment ("OK" or "NG"). "-" appears when there is no NMEA0183 equipment connection.

5.3.6 CAN bus test

This test checks the CAN bus network. Open the diagnostic test options window, select [CAN Bus Test] then push the **Course control** knob.

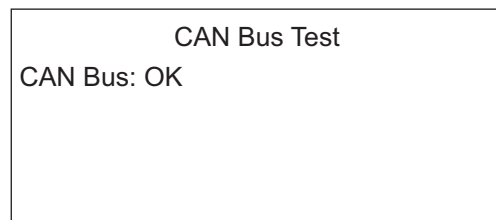

To close the test result, press the  key.

Test result item of the CAN bus test

- [CAN Bus]: Test result of the communication with CAN bus network "OK" or "NG"). "-" appears when there is no CAN bus network connection.

5.3.7 Key test

The key test checks the key operation on the control unit. Open the diagnostic test options window, select [Keyboard Test] then push the **Course control** knob.

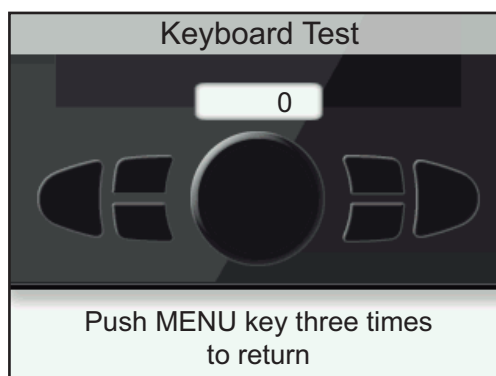

5. MAINTENANCE, TROUBLESHOOTING

Press each key and the **Course control** knob. The related on-screen location fills in blue if the key or knob is normal. Rotate the **Course control** knob. The figure inside the circle on the screen counts up or down with knob rotation.

To finish the test, press the  key three times.

5.3.8 Screen test

The screen test checks the LCD for proper display of colors. Open the diagnostic test options window, select [Screen Test] then push the **Course control** knob. Push the **Course control** knob to change the screen.

To finish the test, press the  key.

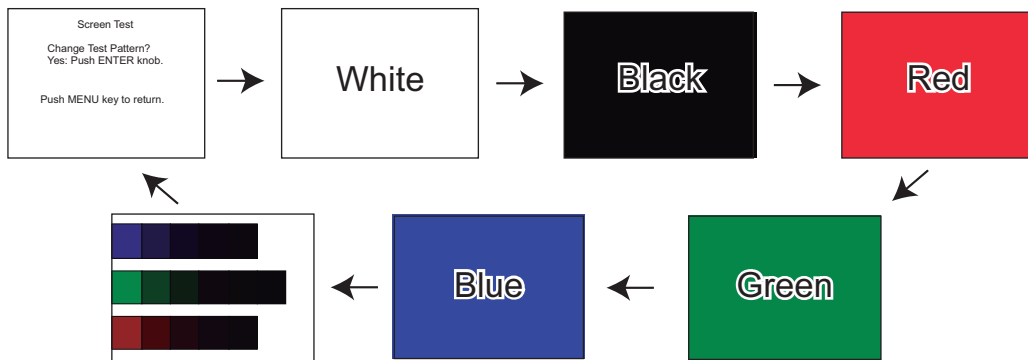

5.3.9 Rudder test

The rudder test checks drive type, presence or absence of bypass/clutch circuit, etc. Open the diagnostic test options window, select [Rudder Test] then push the **Course control** knob.

Note: The rudder test is not available when [Boat Type] is set to [EVCS Boat].

When the rudder reference unit is installed

1. Open the diagnostic test options window, select [Rudder Test] then push the **Course control** knob.

The message shown below appears.

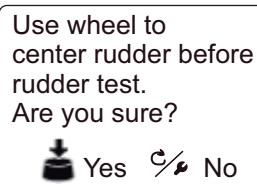

2. Center the rudder then push the **Course control** knob.
During the test, the message shown below appears.

Testing Rudder-PLS Wait.
Push any key to abort

When the rudder test is completed, the message shown below appears.

Rudder test completed.
Push any key to continue

Note: If the rudder test is not completed satisfactory, the steering mode can not be changed from the STBY mode.

- Press any key to show the test result.
For detail of the test result, see "The result of the rudder test" on page 5-9.

For Fantum Feedback™



This rudder test is the different from the one done at installation, in the following respects:

- The adjustment of the rudder speed is not available.
- The result calculated by the rudder test is not reflected to the control of the NAVpilot.

- Open the diagnostic test options window, select [Rudder Test] then push the **Course control** knob.

The message shown below appears.

Use wheel to center rudder before rudder test.
Are you sure?

 Yes  No

- Center the rudder then push the **Course control** knob.
The message shown below appears.

Move rudder to PORT or STBD hard limit by using wheel or arrow key.

 Move Rudder

 Rudder at Hard limit

 Abort

- Turn the helm or press the  or  key hard-over to PORT/STBD then push the **Course control** knob.



The message shown below appears.

Push and hold arrow key pressed to mode rudder to oppsite hard limit.

 Move to STBD

 Move to PORT



 Abort

- Long press the  or  key hard-over in the opposite direction from step 3. While pressing a key, the message shown below appears.

Don't release the key until the rudder has reached the hard limit!

Note: Hold down the key more than three seconds. When you release the key within three seconds, the message shown right appears. Push the **Course control** knob and go back to step 3.

Rudder test is uncompleted. Retry?

 Yes  No

5. MAINTENANCE, TROUBLESHOOTING

5. When the rudder reaches the hard limit, release the ◀ or ▶ key. When you release the key, the message shown below appears.

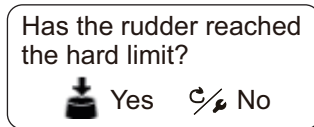

6. Do one of the following.

- If the rudder reached the hard limit properly: Push the **Course control** knob. After pushing the knob, the message shown below appears according to the key pressed at step 4.

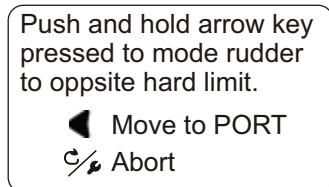

▶ key is pressed at step 4

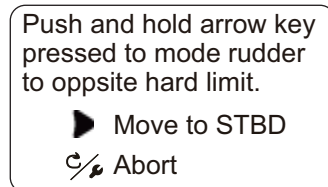

◀ key is pressed at step 4

- If the rudder did not reach the hard limit properly: Press the ⚠ key to show the message below.

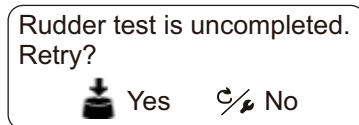

If retry the rudder test, push the **Course control** knob and go back to step 3. If not, press the ⚠ key to abort the rudder test.

7. Long press the ◀ or ▶ key hard-over in the opposite direction from step 4. While pressing a key, the message shown below appears.

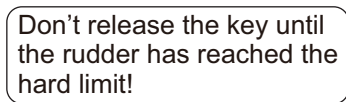

Note: Hold down the key more than three seconds. When you release the key within three seconds, the message shown right appears. Push the **Course control** knob and go back to step 3.

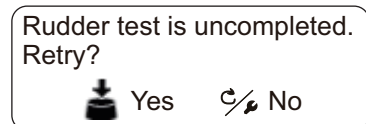

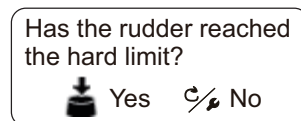

8. When the rudder reaches the hard limit, release the ◀ or ▶ key. When you release the key, the message shown below appears.

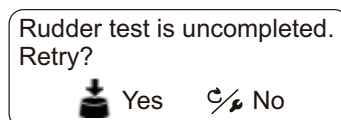

9. Do one of the following.

- If the rudder reached the hard limit properly: Push the **Course control** knob to show the test result. For details of the test result, see "The result of the rudder test" on page 5-9.
- If the rudder did not reach the hard limit properly: Press the ⚠ key to show the following message.



If retry the rudder test, push the **Course control** knob and go back to step 3. If not, press the  key to abort the rudder test.

The result of the rudder test

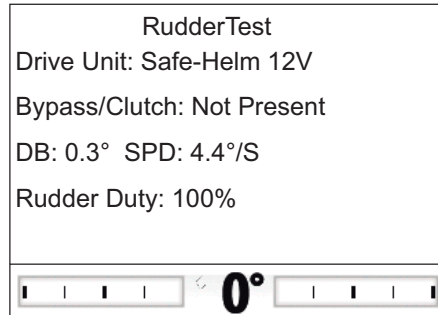

- [Drive Unit]: Drive type used with the NAVpilot.
- [Bypass/Clutch]*: Presence or absence of bypass/clutch.
- [DB]*: Rudder deadband.
- [SPD]*: Rudder speed.
- [Rudder Duty]: The rudder control value required to obtain rudder speed of 5°/sec.
- Rudder angle indicator*: Displays the rudder angle during the rudder test.

*: Not shown with the Fantum Feedback™.

When the rudder test is completed, a message announces the results of the test.

Message	Meaning
Rudder test completed.	Rudder tested OK.
Rudder speed is too fast to control the vessel. The vessel may not be controlled properly.	Rudder speed is too fast.
Rudder speed is too slow to control the vessel. The vessel may not be controlled properly.	Rudder speed is too slow.
Deadband is too big to control the vessel. The vessel may not be controlled properly.*	Deadband is too large.
Deadband is too big rudder speed is too fast to control the vessel. The vessel may not be controlled properly.*	Deadband is too large; rudder speed is too fast.
Deadband is too big rudder speed is too slow to control the vessel. The vessel may not be controlled properly.*	Deadband is too large; rudder speed is too slow.
Rudder test failed.*	Rudder test is failed. Retry the rudder test. If the rudder test is not completed satisfactory, the steering mode can not be changed from the STBY mode.

*: Not shown with Fantum Feedback™.

5.3.10 Helm sensor test

The helm sensor test checks the connection between the Accu-Drive FPS 12V/24V helm sensor and the processor unit. This test is not available for other types of helm sensors.

1. Select [Rudder Test] from the diagnostic test options window then push the **Course control** knob.

The message shown below appears.

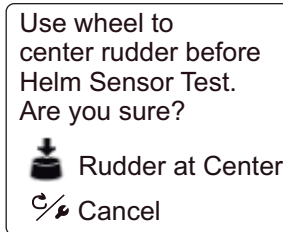

2. Center the rudder then push the **Course control** knob to show one of the following pop-up messages.

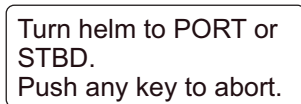

When the RRU is installed

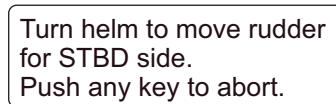

For Fantum Feedback™

3. **When the RRU is installed:** Turn the helm to PORT or STBD direction.
For Fantum Feedback™: Turn the helm to STBD direction.
4. **When the RRU is installed:** Turn the helm to the opposite direction from step 3.
For Fantum Feedback™: Turn the helm to PORT direction.

If the connection is normal, the message "Helm Sensor Test completed. Push ENTER to continue." appears. For failure, "Helm Sensor Test failed. Check the sensor. Push ENTER to continue." appears. Check that your helm sensor is Accu-Drive FPS 12V/24V. Also, check that the helm sensor is correctly connected to the processor unit.

5. Push the **Course control** knob to show the result of the helm sensor test.

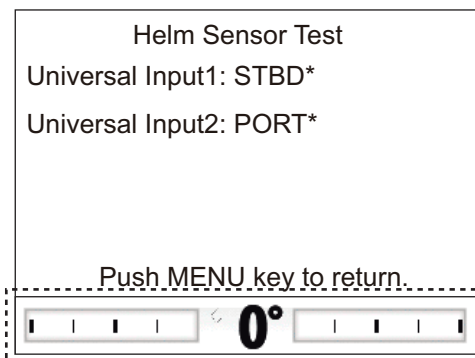

← Not shown with Fantum Feedback™.

*: "--" appears if the test failed.

6. Press the key to finish the test.

5.4 System Data

The system data display allows you to confirm the equipment and drive system status. To show this display, open the [System Setup] menu, select [System Data] then push the **Course control** knob. For details of the [System Setup] menu, see section 4.8.

Input Voltage: 24.4 V
Controller ID: 2
Drive Unit: Reversible 24V
Bypass/Clutch: Not Present
P/C Temp: 71.3°F/91.1°F
Motor Drive Cur: 10.0 A
Bypass Clutch Cur: 0.0 A

To close the system data display, press the  key.

Items on the system data display

- [Input Voltage]: Voltage input to the NAVpilot.
- [Controller ID]: ID of the controller that displays the system data
- [Drive Type]: Drive type used with the NAVpilot. Not shown when [Boat Type] is set to [EVCS Boat].
- [Bypass/Clutch]: Presence or absence of bypass/clutch. Not shown with Fantum Feedback™ or when [Boat Type] is set to [EVCS Boat].
- [P/C Temp]: Temperature of processor unit / control unit.
- [Motor Drive Cur]: Motor drive current. Max. value is 25.0 A.
- [Bypass/Clutch Cur]: Bypass/clutch current. Max. value is 3.0 A. Not shown with Fantum Feedback™.

5.5 Messages

Your equipment displays messages to alert you to potential equipment problem and operation status.

5.5.1 Message pop-up display

When the system detects alarm violation, error, etc., an error message and the alarm icon () appear, and the audio alarm sounds. Confirm the contents of the message, then press any key to close the message and silence the audio alarm. If the error occurs frequently, contact your dealer for advice.

Note: Appropriate measures may be required depending on the content of the alarm or error. See section 5.5.3.

5.5.2 Message board

The message board contains the information about the latest alarm/error messages. To show the message board, do as follows:

1. Long press the  key to open the menu.
2. Rotate the **Course control** knob to select [Message] then push the knob.

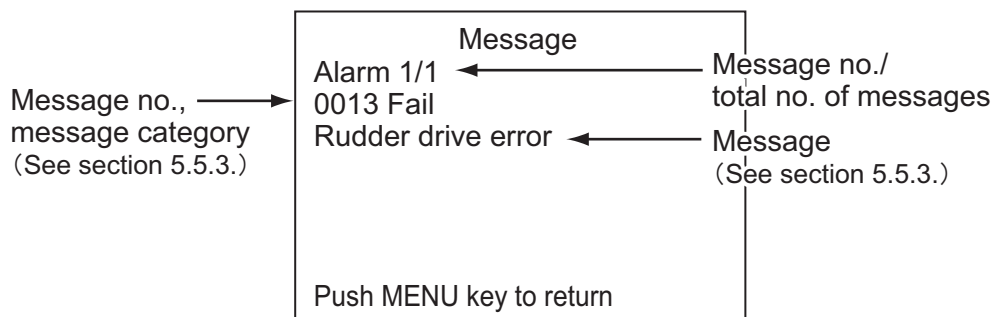

To close the message board, press the  key.

5.5.3 Message description

Error no.	Error message	Meaning, remedy
Alarm		
5101	Deviation alarm	Deviation alarm violated.
5103	Wind deviation alarm	Wind deviation alarm violated.
5105	Arrival alarm	You are nearing a waypoint.
5107	Cross track error	Your boat is off course by the amount set on the XTE alarm.
5203	The preset time has passed.	The watch alarm has activated. Operate any key to confirm presence.
5301	Heading change alarm	Heading change alarm violated.
5303	True wind speed alarm	True wind alarm violated (sailboats only).
5305	App wind speed alarm	Apparent wind alarm violated (sailboats only).
5307	Speed alarm	Speed alarm violated.
5309	Water temp alarm	Water temperature alarm violated.
5311	Depth alarm	Depth alarm violated.
5313	Trip alarm	Your boat has traveled the distance set for the trip alarm.
Error		
1101	Too fast to go fishing mode. Please slow down less than 10 kn.	Set speed below 10 knots then go to respective mode.
1102	Reduce Speed For SABIKI (<5kn)	Speed is in excess of 5 kn. Reduce speed to less than 5 kn to use the SABIKI mode.
1201	Communication error	No communication between processor unit and control unit. Turn off power.
1203	FU remote controller error	Check remote controller.
1301	Missing heading data	Check heading sensor.
1303	Heading data is shifted.	Heading data has changed abruptly. Check heading sensor.
1305	No speed data. Please check speed source or enter manual speed value in Parameter Setup.	Check the speed source or enter the speed manually.

Error no.	Error message	Meaning, remedy
1307	No wind data	Check wind sensor.
1309	Wind data is shifted.	Wind data has changed abruptly. Check wind sensor.
1311	No NAV data. Wait for 1 seconds.	Check nav data sensor.
1315	Degradation of NAV data quality.	Check nav data sensor.
1317	No position data	Check position-fixing equipment.
1801	EVC Interface error	Communication error between the processor unit and IPS interface unit or NMEA data converter. Check the connection with IPS interface unit or NMEA data converter.
1803	No contact with EVC.	Communication error with the EVC system. Check the connection with the EVC system
1901	Rate sensor error	Check rate sensor.
1903	Backup error	All user and engineer default settings are restored. Reenter installation settings.
1905	Initializing heading sensor. This takes two minutes, please wait.	The heading sensor is initializing. Wait approx. two minutes until the heading sensor completes initial-izing.
Fail		
0001	Drive unit error. Please turn OFF and check drive circuit.	Turn off power
0003	Drive unit overloaded. Please turn OFF and check drive circuit.	Turn off power.
0005	Drive unit is overheated. Please turn OFF and check drive circuit.	Temperature of drive circuit is higher than 80°C (176°F). Turn off power.
0007	Bypass/clutch drive error. Please turn OFF and check drive circuit.	Bypass/clutch error. Turn off power.
0009	Bypass/clutch is overloaded. Please turn OFF and check drive circuit.	Bypass/clutch overload. Turn off power.
0011	Bypass/clutch is shorted out. Please turn OFF and check drive circuit.	Bypass/clutch is shorted. Turn off power.
0013	Rudder drive error	Turn off power.
0017	Rudder angle error	Turn off power.
0019	EVC interface fail.	System error of the IPS interface unit or NMEA data converter. Turn off power, and then check the condition of the IPS interface unit or NMEA data converter.
0301	Communication error	No communication between processor unit and all control units. Turn off power.
Notice		
2001	Input voltage is under limit	Input voltage under limit. Check power supply.
2003	Input voltage is over limit	Input voltage over limit. Check power supply.
2101	NAV mode parameter error	Invalid parameter entered in NAV mode. Reenter parameter.
2105	Start to turn by fishing mode	Boat is starting to turn after dodge operation.
2107	Circle mode stopped	Circle mode was stopped.
2109	Mode was changed.	Steering mode changed.
2201	Warning. Remote controller's SW is ON	Remote controller switch is ON. Turn it OFF to continue operation.
2301	Heading source are changed.	Heading source changed.
2303	Wind source are changed.	Wind source changed.

Error no.	Error message	Meaning, remedy
2305	Position source are changed.	Position source changed.
2307	Speed source are changed.	Source of speed changed.
2309	Vessel speed is very slow. Check the speed sensor.	When the STW keeps 0.2 kn or below for 15 seconds while the STW is used for rudder control parameter, this error message appears. Check the STW sensor.
2330	Arrived at waypoint	Arrival alarm alerts you to arrival at final waypoint.
2340	Waypoint was changed	Switching to next waypoint.
2360	No water temp data	Check water temperature sensor.
2362	No depth data	Check depth sensor.
2401	The preset time passed.	The watch alarm has activated. Operate any key to confirm presence.
2370	Helm Sensor error	Check helm sensor.
2801	EVC Override	The OVRD mode is enabled.
2901	No compass adjustment	Check heading sensor.

5.6 Sensor in Use Display

The [Sensor In Use] display provides a comprehensive list of the sensors connected to your NAVpilot.

1. In the STBY mode, long press the  key to open the menu.
2. Rotate the **Course control** knob to select [Sensor In Use] then push the knob. The display shows the source for each data and the equipment identifier number.

Sensor In Use	
HDG : PG-700	: 0019E4
STW : Port 2	
SOG : Port 2	
POSN: Port 1	
Wind : -----	

For example the source of HDG is the FURUNO PG-700 and its equipment identifier number is 0019E4. Dashed lines indicate no connection or sensor is not currently active.

To close the [Sensor In Use] display, press the  key.

6. INSTALLATION AND WIRING

This chapter shows you how to install and wire the control unit FAP-7011C. For the units other than FAP-7011C, see the installation manual (IME-72720).

6.1 Installation

6.1.1 Installation location

Keep in mind the following points when selecting an installation location.

- Select a location with good ventilation.
- Install the unit where shock and vibration are minimal.
- Select a location considering the working and maintenance space for the installation.
- Use the supplied display hard cover when the system is not in use.
- Locate the unit away from heat sources.
- Observe the compass safe distance (standard: 0.50 m, steering: 0.35 m) to prevent interference to a magnetic compass.
- Select a location where the flatness is less than 1 mm.
- The control unit can not be installed at the location where the bulkhead thickness is more than 20 mm.
- As necessary, waterproof around the mounting hole after the installation to prevent water entry.

6.1.2 When FAP-7011 is replaced with FAP-7011C

The width of FAP-7011 is different from that of FAP-7011C.

When FAP-7011 is installed on a desktop

The bracket used for FAP-7011 can not be used with FAP-7011C.

When FAP-7011 is installed with the surface mount

Do one of the following according to the thickness of the bulkhead (d):

- $d \leq 10$ mm:
Using the mount template at the back of this manual, open a hole for the projection of the control unit. Modification to the mounting hole (90 mm diameter) is not required.
- $10 \text{ mm} < d \leq 20$ mm:
Using the mount template at the back of this manual, open a mounting hole of 95 mm diameter, and a hole for the projection of the control unit.

When FAP-7011 is installed with the flush mount

The square mounting hole for FAP-7011 is not compatible with FAP-7011C. Prepare the mounting board for installing FAP-7011C.

6.1.3 How to install the control unit

1. Detach the nut lock then unfasten the toothed nut.

The rear side of the control unit FAP-7011C

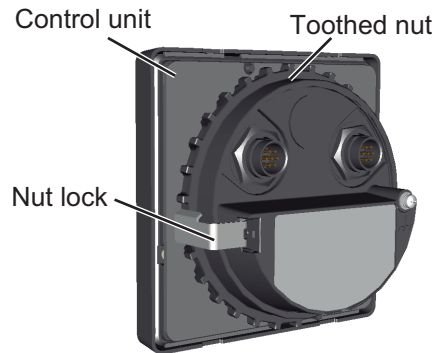

2. Using the mount template at the back of this manual, open a mounting hole in the installation site.

Note: According to the bulkhead thickness (d), the diameter of the mounting hole changes as follows:

- $d \leq 10$ mm: Open a mounting hole of 90 mm in diameter.
- 10 mm $< d \leq 20$ mm: Open a mounting hole of 95 mm in diameter.

3. Attach the surface mount sponge to the mounting location.
Fit the notch of the sponge with the hole for the projection of the control unit to prevent the sponge from blocking the hole.

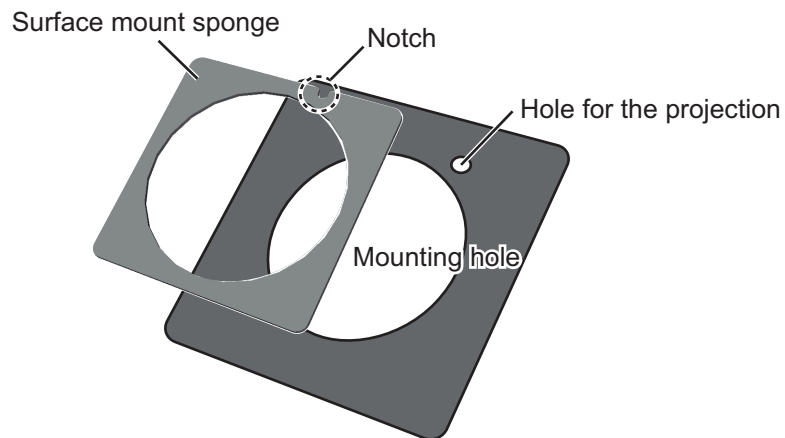

4. Set the unit to the mounting hole.

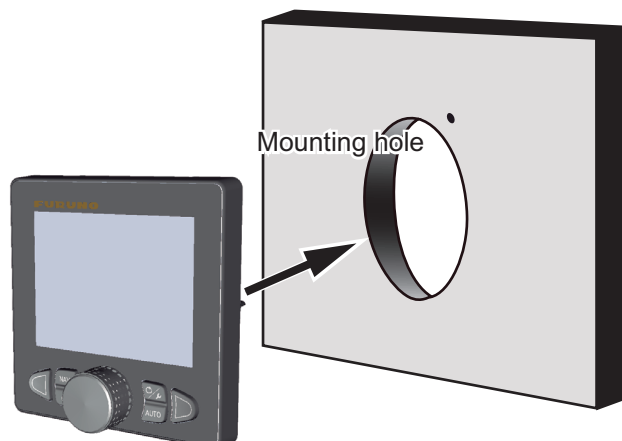

- Fasten the toothed nut to the unit by hand, referring to the illustration below to see how to orient the nut according to the thickness of the bulkhead (d). After fastening the nut, confirm that the unit is fixed stably.

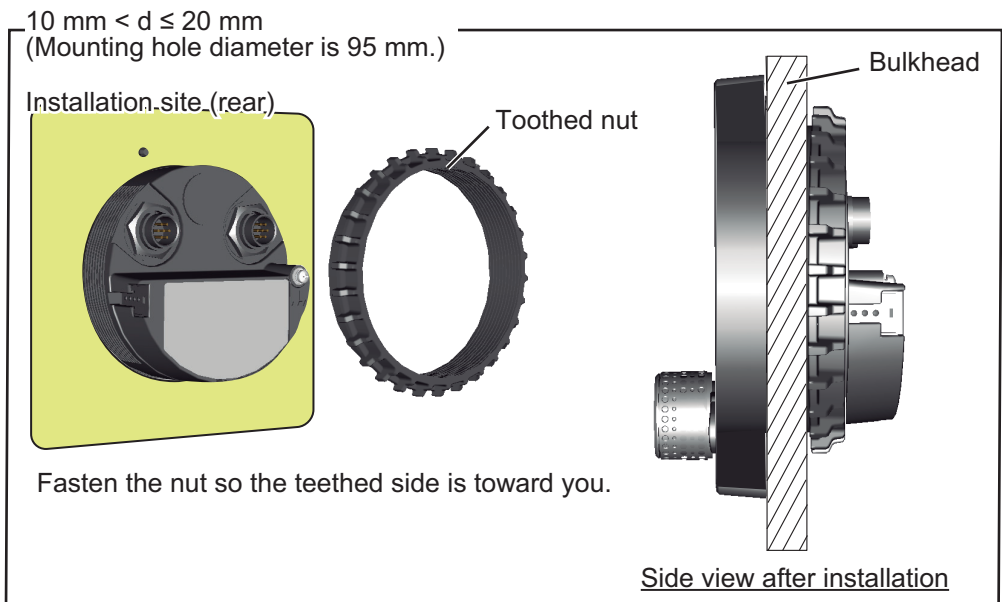
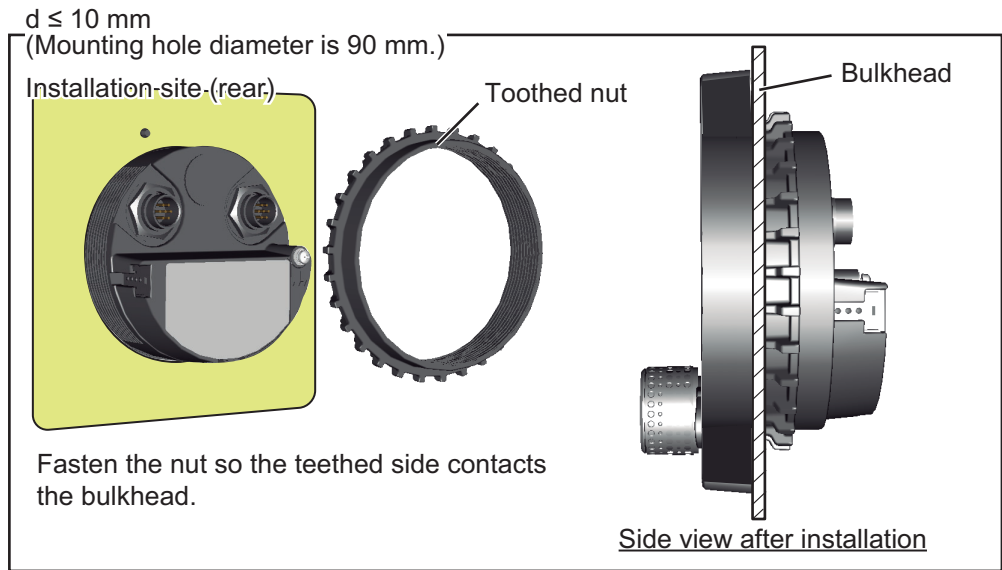

- See the figure below to insert the nut lock all the way in to prevent the toothed nut from loosening.

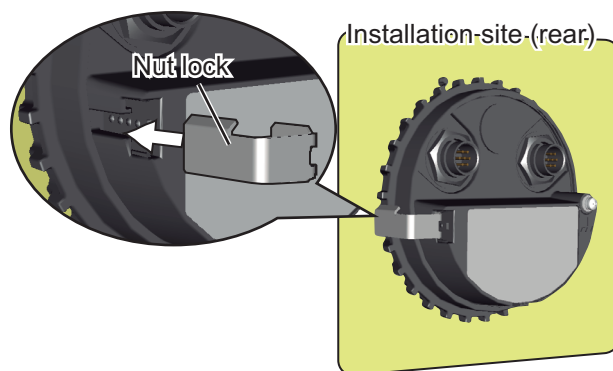

6.2 Wiring

A maximum of six control units can be connected. The TB8 port of the processor unit has two connection lines for the control unit. Three control units can be connected in a daisy chain connection per each connection line.

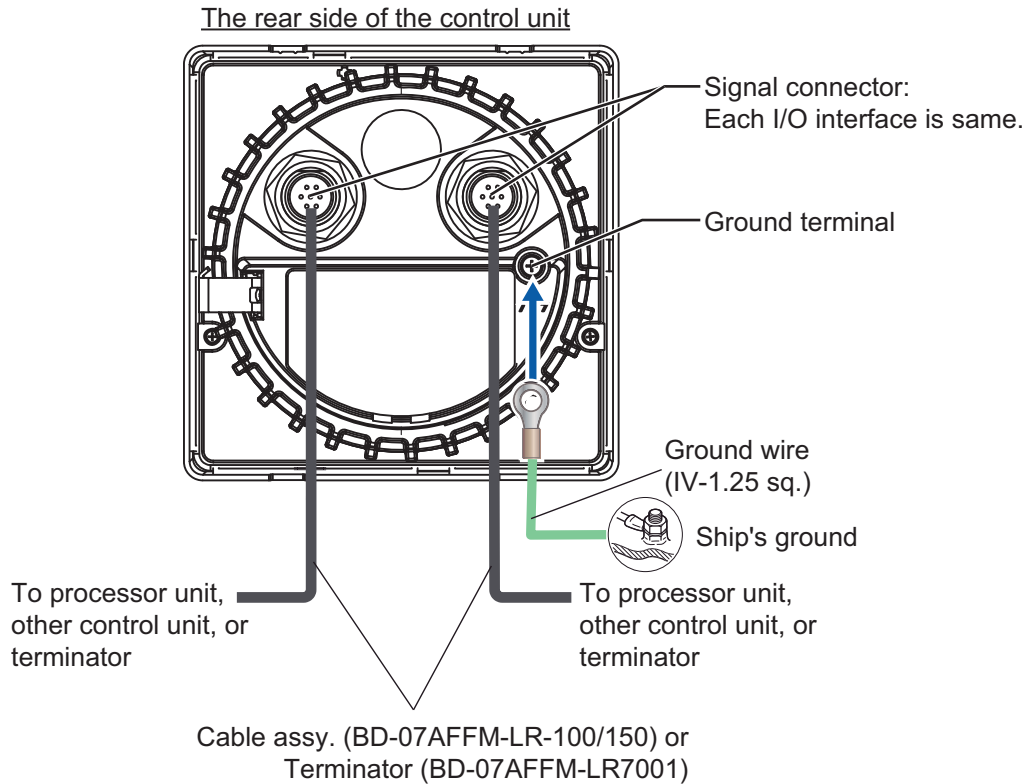

6.2.1 Wiring notices

Keep the following wiring notices in mind.

- To connect a single control unit, use pin no. 1 to 7 of the TB8 port.
- To use both lines of the TB8 port, short pin #3-#4 of the jumper block J104 (default setting: #1-#2 short).

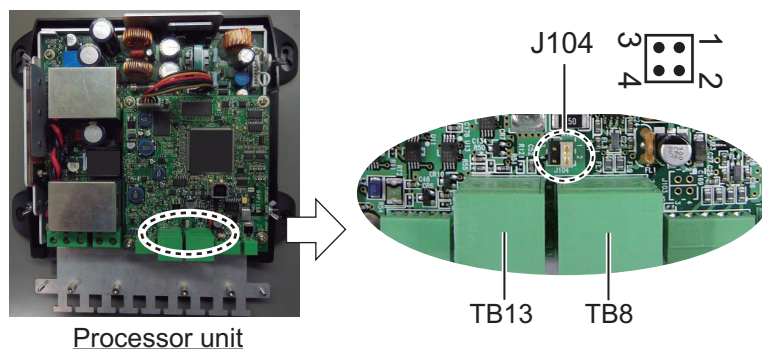

- To connect the control unit to processor unit, use the cable assy. (type: BD-07AF-FM-LR-150).
- To connect the control units in a daisy chain connection, use the optional cable assy. (type: BD-07AF-07AF-LR-100).

- Attach the terminator (type: BD-07AFFM-LR7001) to the port not used on the last control unit in the series. If the terminator is not attached, the control unit may not work properly.
- The total length of cables in a series must be within 30 m.

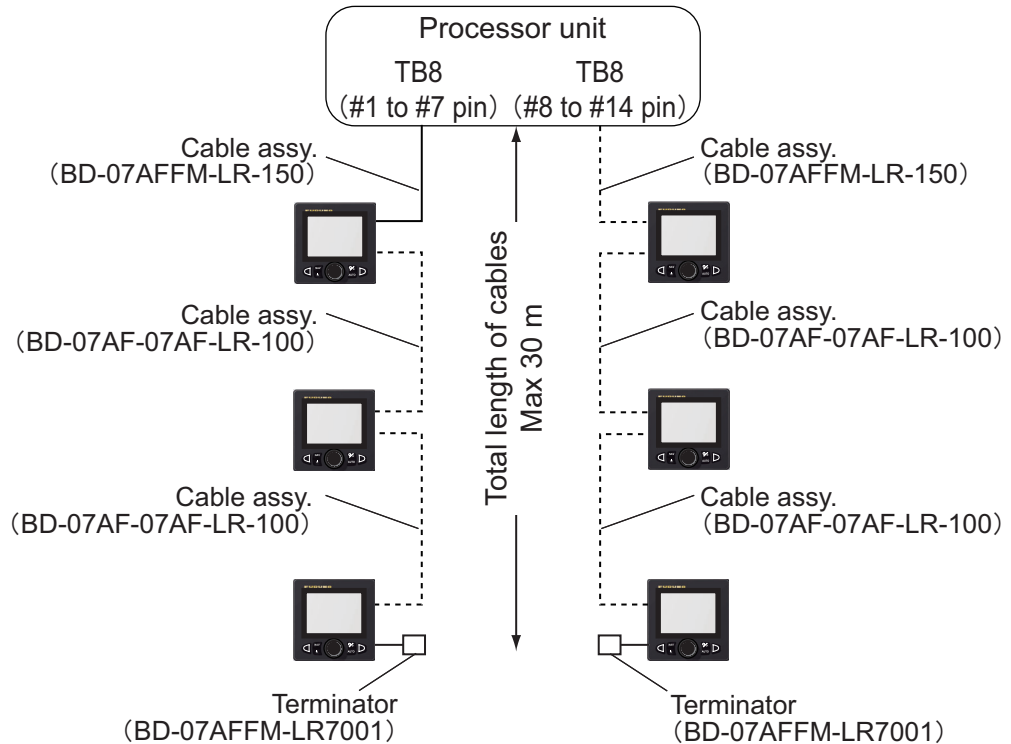

6.2.2 Connection with the processor unit

Do as follows to connect the control unit to the TB8 port on the processor unit.

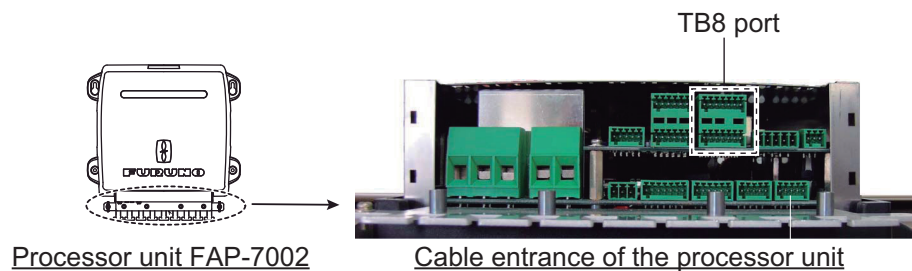

1. Remove the outside cover of the processor unit; hold the right and left sides of the cover and pull the cover outward.

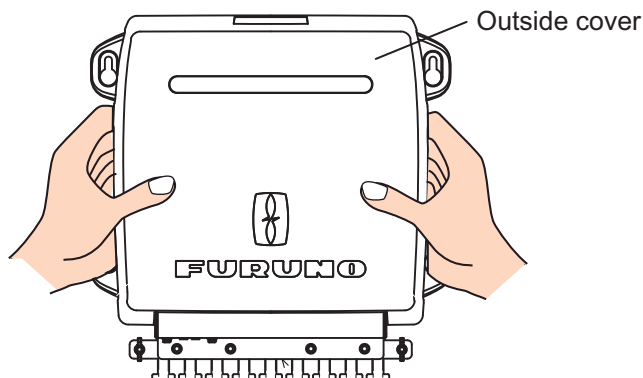

6. INSTALLATION AND WIRING

- Remove the four screws circled below.

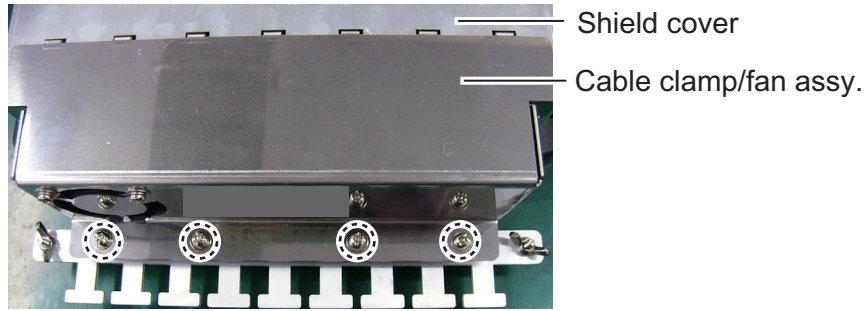

- Remove the cable clamp/fan assy. from the shield cover.
Note: When removing the cable clamp/fan assy., be careful not to apply tension to the fan connector.
- Disconnect the fan connector.

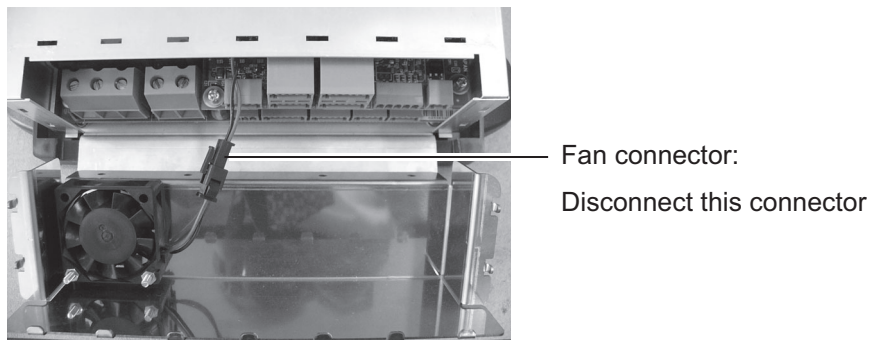

- Put the cable cores of the cable assy. (type: BD-07AFFM-LR-100/150) into their correct connector block, then connect to the TB8 port.

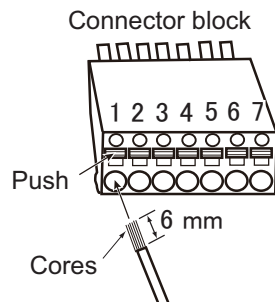
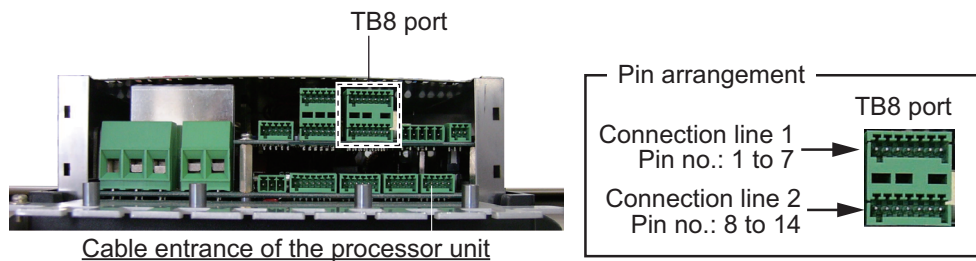

How to put wire into connector block

- Make length of cores 6 mm.
- Twist cores.
- Push spring-loaded catch with slotted-head screwdriver.
- Insert core into hole.
- Release screwdriver.
- Pull wire to confirm it is securely inserted.

Pin no.	Signal	Color	Pin no.	Signal	Color
1	POWER_SW1	White	8	POWER_SW2	White
2	GND	Blue	9	GND	Blue
3	CAN1_H	Yellow	10	CAN2_H	Yellow
4	CAN1_L	Green	11	CAN2_L	Green
5	12V_P	Red	12	12V_P	Red
6	GND	Black	13	GND	Black
7	SHIELD	Drain	14	SHIELD	Drain

6. Fix the cable assy. to the cable clamp with a cable tie (supplied with processor unit).
7. Connect the fan connector.
8. Reattach the cable clamp/fan assy. and outside cover.

6.2.3 Auto steering cancel button

Install a control unit equipped with the **STBY** key, or an “auto steering cancel button” (local supply) at the helm and all steering stations, to disable rudder control by the autopilot in an emergency. Install the button where it can be easily operated.

Do the following to install the auto steering cancel button:

- 1) As shown in the figure below, connect an event switch (local supply) to GENERAL IN (TB5) of the processor unit. A maximum of two can be connected.

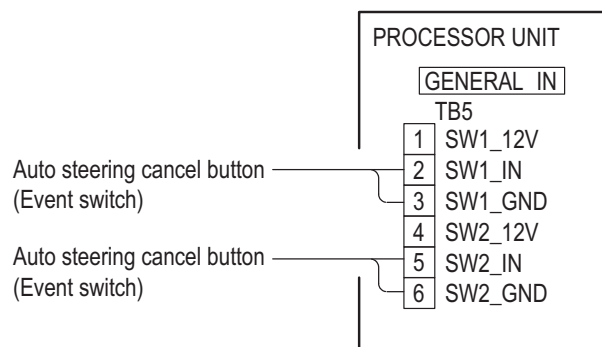

- 2) Change the setting of the GENERAL IN port. See section 7.8.1.

When the auto steering cancel button is pressed, autopilot rudder control is disabled and the steering mode changes to the STBY mode (manual steering).

6.2.4 Connection for the interface kit

When the VOLVO or YAMAHA EVC system is connected to the processor unit FAP-7002, the optional interface kit (FAP-6300/6310) is required. The optional T-connector, terminator and cable assembly are required for connection between the IPS interface unit and the gateway unit.

Refer to the Interface kit installation instructions (C72-01301) for details.

6. INSTALLATION AND WIRING

This page is intentionally left blank.

7. INITIAL SETTINGS

This chapter shows you how to enter initial settings, on the [Installation Menu] window. The menu contains some items that may not apply to your system. Minimally, the settings on the following menus must be done:

- [Ship's Characteristics] menu
- [Dockside Setup] menu

Note: The [Dockside Setup] menu is not shown when [Boat Type] is set to [EVCS Boat].

7.1 How to Select Language and Units, Open the Installation Menu Window

1. Press the  key to turn on the power.
The first time the system is powered, the language selection window appears.

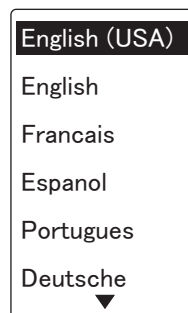

2. Rotate the **Course control** knob to select a language then push the knob.
3. Press the  key to open the [Units Setup] menu.
The units on the [Units Setup] menu are set according to the language selected.

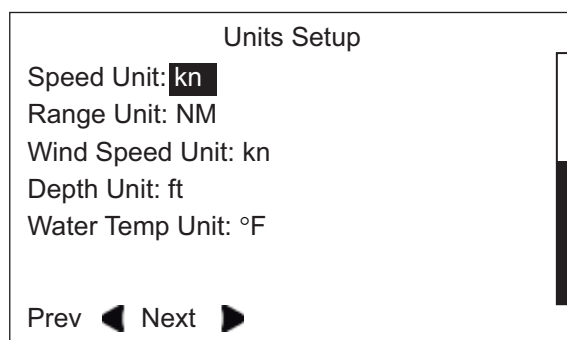

4. If you want to change the units, do as follows. If not, go to the next step.
 - 1) Rotate the **Course control** knob to select the current setting to change then push the knob.
 - 2) Rotate the **Course control** knob to select a unit then push the knob.

7. INITIAL SETTINGS

- Press the **D** key to open the [Operation Mode] menu.

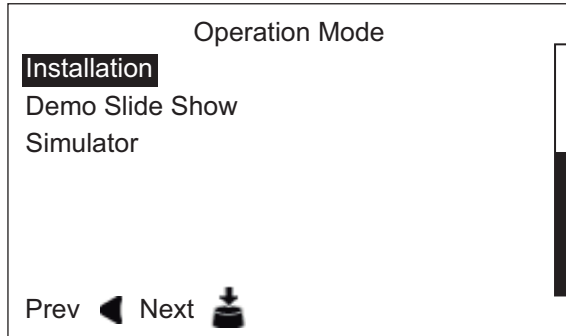

- The cursor is selecting [Installation]; push the **Course control** knob. The [Installation Menu] window appears.

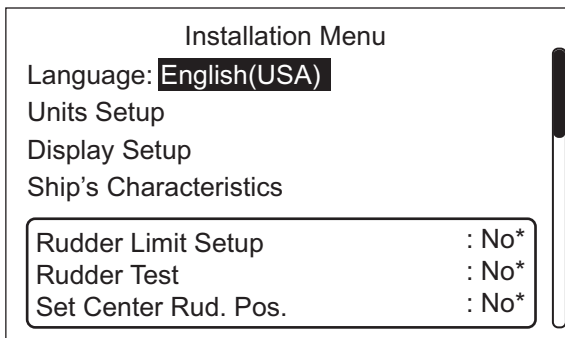

*: "No" is replaced with "Done" when respective setup is successfully completed.

Note 1: The items on the [Installation Menu] window change according to your system.

Note 2: The [Installation Menu] window can be opened from the STBY mode by pressing the **Course control** knob three times while holding down the **Q** key.

- Follow the procedures in the remaining sections (in the order shown) of this chapter to set up the NAVpilot.

7.2 Display Setup

The [Display Setup] menu sets up the display indications according to your needs, like how to show the data and time. To open the [Display Setup] menu, select [Display Setup] from the [Installation Menu] window.

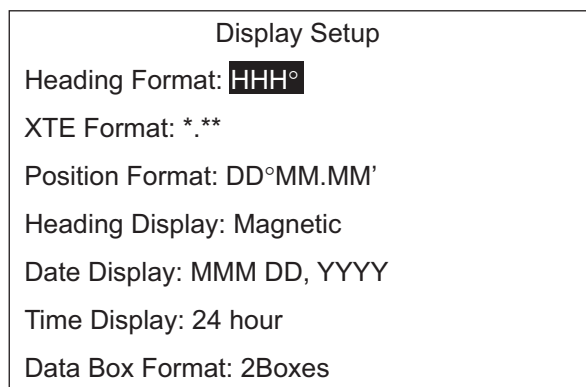

Items of the [Display Setup] menu

Item, description	Settings	Item, description	Settings
[Heading Format] Select how to show the heading indication, in three or four figures.	HHH° HHH.H°	[Date Display] Select how to show the date.	MMM DD, YYYY DD MMM YYYY YYYY MM DD
[XTE Format] Select how to show the XTE indication, in three or four figures.	*.** *.**	[Time Display] Select how to show the time.	12hour 24hour
[Position Format] Select how to show the position indication, in degrees, minutes, seconds,	DD°MM.MM' DD°MM.MMM' DD°MM.MMMM' DD°MM.SS.S"	[Data Box Format] Select how many data boxes to show on the nav data box. To show the nav data, appropriate sensors are required.	1Box 2Boxes
[Heading Display] Select how to show heading, true or magnetic.	Magnetic True		

7.3 Ship's Characteristics Menu

The [Ship's Characteristics] menu sets up the NAVpilot according to boat type, length, etc. To open the [Ship's Characteristics] menu, select [Ship's Characteristics] from the [Installation Menu] window.

Ship's Characteristics

Boat Type: **Semi-Displace**

Rudder Sensor*: Installed

SABIKI Mode*: OFF

Boat Length: 40ft (12.2m)

Cruising SPD: 30kn

Rate of Turn: 5°/s

Response Type: Standard

*: Shown when [Boat Type] = [Planing] or [Semi-Displace].

- The cursor is selecting the current setting for [Boat Type]; push the **Course control** knob.

Planing	—	Jet boats, fast patrol boats, sport fishing boats
Semi-Displace	—	Pilot boats, power boats, fast catamaran boats
Displacement	—	Pedal boats, fishing boats, work boats, houseboats
Sailboat	—	Sailboats
EVCS Boat	—	EVC system equipped boats

- Rotate the **Course control** knob to select your boat type then push the knob. When you select [Planing] or [Semi-Displace], the following items appear on the [Ship's Characteristics] menu.

Menu item	Description
[Rudder Sensor]	Change settings for the rudder sensor. <ul style="list-style-type: none"> • [Installed]: Rudder reference unit is installed. • [Fantom Feedback]: Rudder reference unit is not installed.
[SABIKI Mode]	Activate/deactivate SABIKI mode. When SABIKI mode is activated, the menu is changed accordingly. See section 2.7 for more information. Select [ON] to activate, [OFF] to deactivate SABIKI mode. <p>Note: SABIKI mode is only available for vessels under 40 ft with outboard engines.</p>

Note 1: If [Boat Type] is changed after completion of the installation settings, re-enter initial settings to reflect change in boat type.

Note 2: When [SABIKI Mode] is active, or [Rudder Sensor] is set to [Fantom Feedback], the options for [Boat Type] are limited to [Planing] or [Semi-Displace].

3. Set [Boat Length], [Cruising Speed], [Rate of Turn], and [Response Type] as follows:
 - 1) Rotate the **Course control** knob to select the current value of an item then push the knob.
 - 2) Rotate the **Course control** knob to set a value then push the knob.

Note 1: Set the [Rate of Turn] according to your boat's specifications. If the rate is set higher than your boat's specifications, the rudder may turn abruptly when arriving at a waypoint, creating a dangerous situation. Further, it may not be possible to change course correctly if the rate is higher than the actual rate of turn of your boat.

Note 2: [Response Type] switches the parameters of the adjustment function according to the ship type. The adjustment function is a fixed parameter setting that adjusts the control parameters when automatic adjustment of them does not suit the ship. For other than wide-beam ships, set the [Response Type] to [Standard]. If the ship has a wide beam and control is affected, set to [WB01] or [WB02]. Compared to [Standard], [WB01] and [WB02] increase the counter rudder. [WB02] has a higher gain than [WB01].

7.4 Dockside Setup Menu

The [Dockside Setup] menu for the rudder reference unit (RRU) and Fantom Feedback™ is different. To open the [Dockside Setup] menu, select [Dockside Setup] from the [Installation Menu] window.

Note: The [Dockside Setup] menu is not shown when [Boat Type] is set to [EVCS Boat].

7.4.1 Dockside setup for the rudder reference unit

Dockside Setup

Select RRU Type: **Rotary (Inboard)**

RRU Sensor Alignment

Air Bleeding: No

Rudder Limit Setup

Auto Rudder Limit:

Manual Rudder Limit:

Rudder Test: No

RRU type

1. Select the current setting for [Select RRU Type] from the [Dockside Setup] menu then push the **Course control** knob.
2. Rotate the **Course control** knob to select a correct option then push the knob.
 [Rotary(Inboard)]: For FURUNO rudder reference unit FAP-6112.
 [Linear(Outboard)]: For Teleflex linear sensor AR4502.

Rotary (Inboard)

Linear (Outboard)

RRU sensor alignment

1. Select [RRU Sensor Alignment] from the [Dockside Setup] menu then push the **Course control** knob.
 The message shown below appears.

Measure rudder center position and confirm displayed value is $< 5^\circ$ if not, adjust RRU arm or magnet. NAVPILOT will correct reversed PORT & STBD indication later. Push any key to continue

2. Press any key to show the window shown below.

RRU Sensor Alignment

Alignment Tone: **ON**

Push MENU key to Return

0°

3. With the rudder physically centered, confirm that the displayed rudder angle indication is less than or equal to $\pm 5^\circ$. If not, you must adjust the rudder sensor body or magnet position (For Teleflex linear sensor AR4502) so that the indicator is within $\pm 5^\circ$ before continuing.

Note: If the rudder angle indication shows “*9°”, input data exceed the display range or the processor unit does not detect the rudder reference unit. Check the connection with the rudder reference unit.

7. INITIAL SETTINGS

[Alignment Tone]: There is an alignment tone that you can use to help you make this adjustment remotely. A beep sounds continuously when the indicator is within $\pm 5^\circ$. If you do not need the alignment tone, set [Alignment Tone] to [OFF].

4. Press the  key to close the [RRU Sensor Alignment] window.

Air bleeding

1. Select the option for [Air Bleeding] from the [Dockside Setup] menu then push the **Course control** knob.
2. Rotate the **Course control** knob to select [Yes] then push the knob.

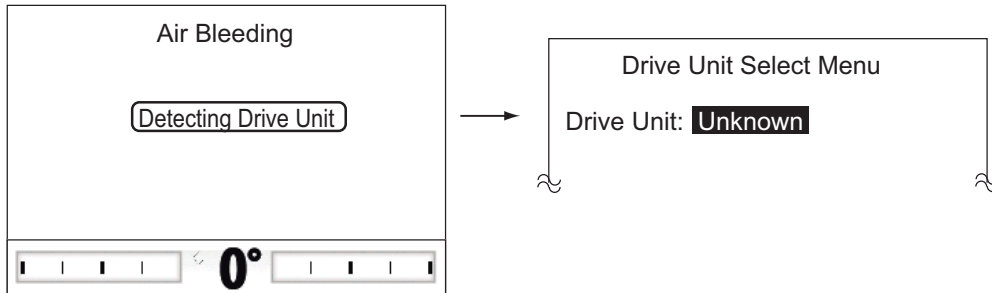

The message “Detecting Drive Unit” appears while detecting your drive unit. If your drive unit is “Reversible” or the drive unit can not be detected, the drive selection menu appears. If your drive unit is “Solenoid”, the drive selection menu does not appear.

3. Select [Unknown] then push the **Course control** knob to show the window below. If the drive unit selection menu does not appear, go to step 6.

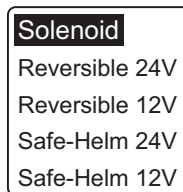



4. Rotate the **Course control** knob to select the drive unit then push the knob. If you select [Safe-Helm 12V (or 24V)], the message shown below appears. Push the knob to close the message.

A helm Sensor is Installed. Safe Helm and Power Assist are available. Push ENTER to continue.

5. Confirm that the message shown below appears then push the  key.

Push arrow keys to enable pumpset
Push MENU key when done

6. Press the  key until the indicator is completely filled.
7. Remove the appropriate rudder cap of the cylinder to bleed air, then reattach the cap.
8. Press the  key until the indicator is completely filled.
9. Remove the appropriate rudder cap of the cylinder to bleed air, then reattach the cap.
10. Repeat step 6 - 9 to bleed air completely.
11. Press the  key to finish the air bleeding.

Rudder limit setup

Set the rudder center position, then set the maximum rudder limits or “hard-over“ points for the rudder system.

NAVpilot automatically sets the port/starboard direction of the rudder angle in this step. It does not matter which way the rudder reference unit arm or linear sensor rod is installed as this correction will be done electronically. Therefore, it is recommended that you make both port and starboard rudder values the same.

1. Select [Rudder Limit Setup] from the [Dockside Setup] menu then push the **Course control** knob.

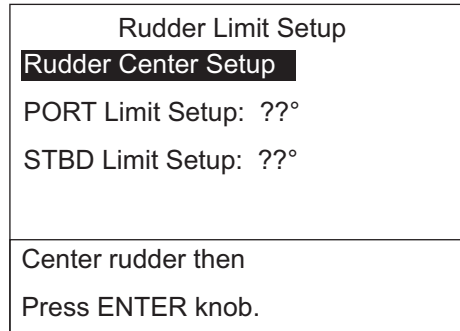

2. The cursor is selecting [Rudder Center Setup]; push the **Course control** knob. The message shown below appears.

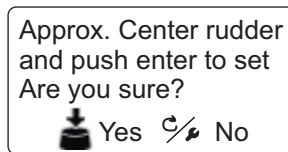

3. Turn the helm so the rudder is centered then push the **Course control** knob.
4. Rotate the **Course control** knob to select the current setting value for [PORT Limit Setup] then push the knob.
5. Turn the helm hard-over to port then enter the port rudder limit.
6. Rotate the **Course control** knob to select the current setting value for [STBD Limit Setup] then push the knob.
7. Turn the helm hard-over to starboard then enter the starboard rudder limit.

Note: If one of the following messages appears, retry the rudder limit setup. If the message appears again, adjust the rudder reference unit.

- RRU center pos is out of range-turn helm or adjust RRU then try again.
- RRU STBD (or PORT) pos is out of range-turn helm or adjust RRU then try again.
- RRU Setup Error-Must turn helm hard over PORT/STBD. Retry?

When you try to escape from the [Rudder Limit Setup] menu and there is some un-completed setting items, the message shown below appears. Confirm the items shown on the message, and do the uncompleted items.

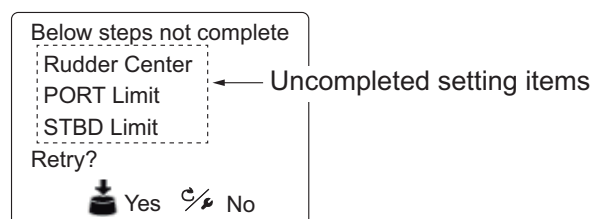

7. INITIAL SETTINGS

Auto rudder limit

Auto rudder limit determines the maximum rudder movement in degrees from the mid position in the AUTO, NAV, Turn, FishHunter™, Dodge and WIND modes. The value set here should not be greater than the limit set for the rudder limit.

Complete the rudder limit setup before entering the auto rudder limit.

1. Select the current setting value for [Auto Rudder Limit] from the [Dockside Setup] menu then push the **Course control** knob.
2. Rotate the **Course control** knob to set the rudder limit desired then push the knob (setting range: 10° to max. rudder limit).
Set the auto rudder limit angle to a value less than the maximum rudder angle (set in the [Rudder Limit Setup] menu). Generally, set the value approx. 10% lower than the value set in the [Rudder Limit Setup] menu.

Manual rudder limit

In the remote (FU and NFU), FU dodge or NFU dodge modes, usually a wide range of rudder angles are used, and therefore a larger number should be entered. however, the setting must not exceed the rudder limit angle which is inherent on your boat.

Do not set the limit higher than the rudder limit. It is recommended to set the manual rudder limit equal to or greater than the auto rudder limit. If the manual rudder limit is set lower than the auto one, the rudder may be returned to center position too quickly when the vessel is doing automatic turning by operation from the remote controller or the dodge key.

Complete the rudder limit setup before entering the manual rudder limit.

1. Select the current setting value for [Manual Rudder Limit] from the [Dockside Setup] menu then push the **Course control** knob.
2. Rotate the **Course control** knob to set the rudder limit desired then push the knob (setting range: 10° to max. rudder limit).

Rudder test

For power steering vessels with an engine-driven power steering pump, the engines must be running and slightly above idle before doing this test. Also, BEFORE doing this test, check that [Rudder Deadband] in the [Sea Trial] menu is set to [Auto].

1. Select the option for [Rudder Test] from the [Dockside Setup] menu then push the **Course control** knob.
2. Rotate the **Course control** knob to select [Yes] then push the knob.
3. Push the **Course control** knob to start the rudder test.

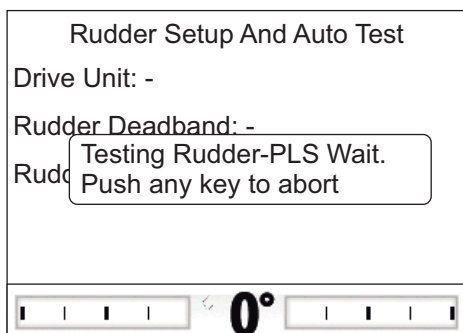

The rudder test automatically detects the drive unit.

- Solenoid: The test automatically continues.
- Reversible: The drive selection menu appears. Select the drive unit. Then, the test continues.

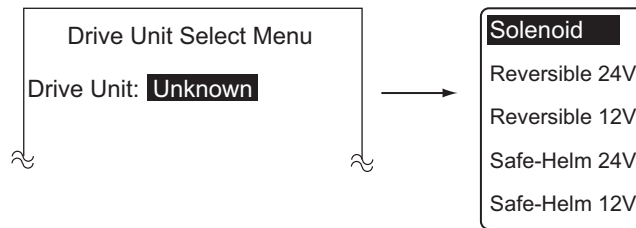

After the test is completed, one of the following messages appears.

- Rudder Test completed. Push any key to continue.
- Rudder speed is too slow (fast) to control the vessel. The vessel may not be controlled properly.

Note 1: When one of the following messages appears, the rudder test could not be completed successfully. Retry the test after resolving the problem.

- Rudder Test Failed.
- RUDDER ANGLE ERROR. Check drive circuit.
- RUDDER DRIVE ERROR. Check drive circuit.

Note 2: When the message "Deadband is too big to control the vessel. The vessel may not be controlled properly. Please see inst manual for manual db setting. Push any key to continue." appears, set the rudder deadband manually (see section 7.9.2).

4. Press any key to show the rudder test result.

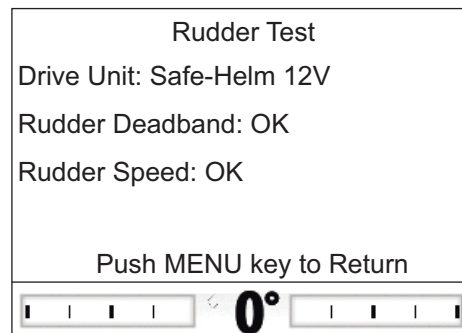

- [Drive Unit]: Drive type used with the NAVpilot: [Reversible 12V (or 24V)], [Safe-Helm 12V (or 24V)], or [Solenoid].
- [Rudder Deadband]: Rudder Deadband ([OK] or [Big])
- [Rudder Speed]: Rudder speed ([OK], [Fast], or [Slow])

Note 1: If the rudder deadband is higher than 1.3°, the boat can not be controlled correctly. Check for air in the steering system and if the rudder speed is greater than 10°/s.

Note 2: Do not turn the power off within two seconds after finishing the rudder test. If the power is turned off accidentally, retry the rudder test.

5. Press the  key to close the rudder test window.

7.4.2 Dockside setup for Fantum Feedback™

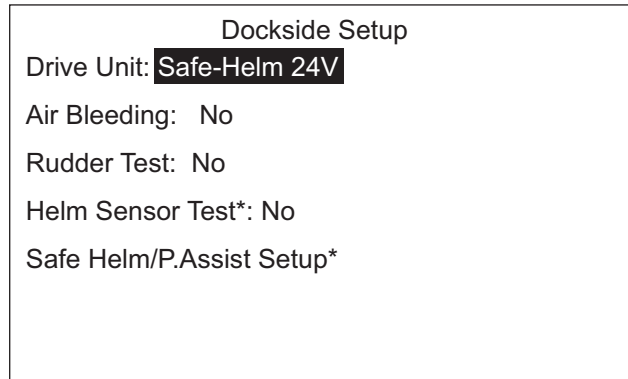

*: Displayed if Accu-Steer drive unit is selected.

Drive unit setup



1. Select the current setting for [Drive Unit] from the [Dockside Setup] menu then push the **Course control** knob.
2. Rotate the **Course control** knob to select the drive unit type then push the knob. Setting option: [Reversible 24V], [Reversible 12V], [Safe-Helm 24V], [Safe-Helm 12V]

Air bleeding

Air bleeding can not be performed if the drive unit has not been selected.

1. Select the option for [Air Bleeding] from the [Dockside Setup] menu then push the **Course control** knob.
2. Rotate the **Course control** knob to select [Yes] then push the knob. The message shown below appears.

Push arrow key to enable pumpset
Push MENU key when done



3. Press the  key.
4. Remove the appropriate rudder cap of the cylinder to bleed air, then reattach the cap.
5. Press the  key.
6. Remove the appropriate rudder cap of the cylinder to bleed air, then reattach the cap.
7. Repeat steps step 3-6 to bleed air completely.
8. Press the  key to finish air bleeding.

Rudder test



The rudder test can not be performed if the drive unit has not been selected.



1. Select the option for [Rudder Test] from the [Dockside Setup] menu then push the **Course control** knob.



2. Rotate the **Course control** knob to select [Yes] then push the knob.
The message shown below appears.



Use wheel to center rudder before rudder test.
Are you sure?
 Yes  No





3. Center the rudder then push the **Course control** knob.
The message shown below appears.



Push and hold STBD arrow key until rudder moves.
 Move Rudder
 Abort



4. Press the  key and confirm the direction of rudder movement.
5. Release the  key.
The message shown below appears.



Which side did rudder move to?
 STBD side
 PORT side
 Not Move/Abort

6. Press the  or  key according to the direction of rudder movement found in step 4.
The message shown below appears.

Move rudder to PORT or STBD hard limit by using wheel or arrow key.
  Move Rudder
 Rudder at Hard limit
 Abort

7. Turn the helm or press the  or  key hard-over to PORT/STBD then push the **Course control** knob.
The message shown below appears.



Push and hold arrow key pressed to move rudder to opposite hard limit.
 Move to STBD
 Move to PORT
 Abort



8. Long press the  or  key hard-over in the opposite direction from step 7.
While pressing a key, the message shown right appears.



Don't release the key until the rudder has reached the hard limit!

7. INITIAL SETTINGS

Note: Hold down the key more than three seconds. When you release the key within three seconds, the message shown right appears. Push the **Course control** knob and go back to step 7.



Rudder test is uncompleted.
Retry?
 Yes  No



9. When the rudder reaches the hard limit, release the  or  key to display the message shown right.

Has the rudder reached the hard limit?
 Yes  No

10. Do one of the following.

- If the rudder reached the hard limit properly: Push the **Course control** knob. After pushing the knob, the message shown below appears according to the key pressed at step 8.



Push and hold arrow key pressed to mode rudder to oppsite hard limit.
 Move to PORT
 Abort

Push and hold arrow key pressed to mode rudder to oppsite hard limit.
 Move to STBD
 Abort



 key is pressed at step 8

 key is pressed at step 8

- If the rudder did not reach the hard limit properly: Press the  key to show the following message.



Rudder test is uncompleted.
Retry?
 Yes  No



If retry the rudder test, push the **Course control** knob and go back to step 7. If not, press the  key to abort the rudder test.



11. Long press the  or  key hard-over in the opposite direction from step 8. While pressing a key, the message shown right appears.

Don't release the key until the rudder has reached the hard limit!

Note: Hold down the key more than three seconds. When you release the key within three seconds, the message shown right appears. Push the **Course control** knob and go back to step 7.

Rudder test is uncompleted.
Retry?
 Yes  No

12. When the rudder reaches the hard limit, release the  or  key to display the message shown right.

Has the rudder reached the hard limit?
 Yes  No

13. Do one of the following.

- If the rudder reached the hard limit properly: Push the **Course control** knob. After the test is completed, one of the following messages appears.
 - Rudder test completed. Push any key to continue.
 - Rudder speed is too slow (fast) to control the vessel. The vessel may not be controlled properly.

If the steering speed needs to be adjusted, the following message appears. To adjust the steering speed, push the **Course control** knob and go back to step 7. If adjustment is not required, press the  key to abort the rudder test.

Rudder speed is not appropriate. Retry test to adjust rudder speed?

 Adjust
 Abort

- If the rudder did not reach the hard limit properly: Press the  key to show the following message.

Rudder test is uncompleted. Retry?

 Yes  No

If retry the rudder test, push the **Course control** knob and go back to step 7. If not, press the  key to abort the rudder test.

14. Push any key to show the rudder test result.

Rudder Test

Drive Unit: Safe-Helm 12V
Rudder Speed: OK
Rudder Drive Level: 11

Push MENU key to Return

- [Drive Unit]: Drive type used with the NAVpilot: [Reversible 12V (or 24V)] or [Safe-Helm 12V (or 24V)]
- [Rudder Speed]: Rudder speed ([OK], [Fast], or [Slow])
- [Rudder Drive Level]: The amount of helm operation required to move the rudder.

Note: Do not turn the power off within two seconds after finishing the rudder test. If the power is turned off accidentally, retry the rudder test.

15. Press the  key to close the rudder test window.

7.4.3 How to set the safe helm mode and power assist mode

The safe helm and power assist features are available with the Accu-Steer FPS 12V (or 24V) drive unit. If your drive unit is different, go to section 7.4.4.



Perform the helm sensor test before safe helm and power assist setup.

Helm sensor test (for Accu-Steer FPS 12V (or 24V) drive)

The helm sensor test checks the connection between the processor unit and the Accu-Steer FPS 12V (or 24V) drive.

1. Select the option for [Helm Sensor Test] from the [Dockside Setup] menu then push the **Course control** knob.
2. Rotate the **Course control** knob to select [Yes] then push the knob. The message shown below appears.

Use wheel to center rudder before Helm Sensor Test. Are you sure?

 Rudder at Center
 Cancel

7. INITIAL SETTINGS

- Center the rudder then push the knob to show one of the following messages.

Turn helm to PORT or STBD.
Push any key to abort.

When the RRU is installed

Turn helm to move rudder for STBD side.
Push any key to abort.

For Fantum Feedback™

- When the RRU is installed:** Turn the helm to PORT or STBD direction.
For Fantum Feedback™: Turn the helm to STBD direction.
- When the RRU is installed:** Turn the helm to the opposite direction from step 4.
For Fantum Feedback™: Turn the helm to PORT direction.
If the connection is normal, the message "Helm Sensor Test completed. Push ENTER to continue." appears. For failure, "Helm Sensor Test failed. Check the sensor. Push ENTER to continue." appears. Check that your helm sensor is Accu-Drive FPS 12V/24V. Also, check that the helm sensor is correctly connected to the processor unit.

- Push the **Course control** knob to show the helm sensor test result.

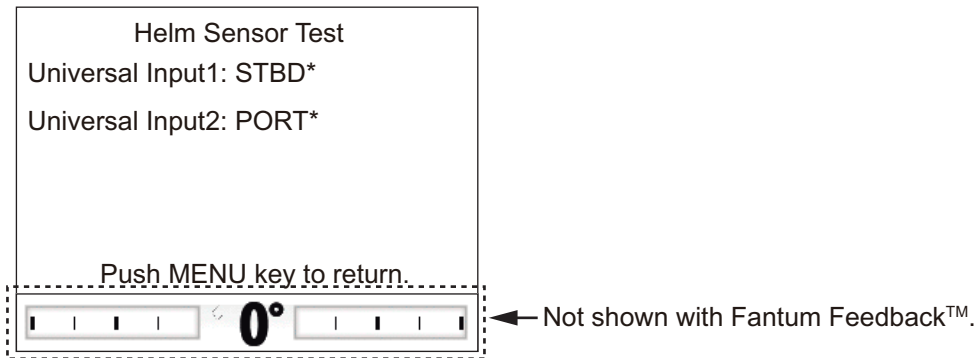

*: "--" appears if the test failed.

- Press the  key to finish the helm sensor test.

Safe helm setup (for Accu-Steer FPS 12V (or 24V) drive)

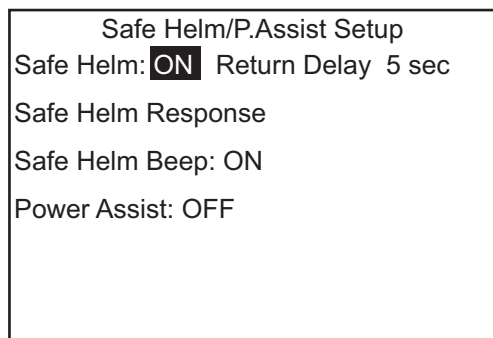

Perform the helm sensor test before doing the safe helm setup. For details of the helm sensor test, see "Helm sensor test (for Accu-Steer FPS 12V (or 24V) drive)" on page 7-13.

- Select [Safe Helm/P.Assist Setup] from the [Dockside Setup] menu then push the **Course control** knob.
[Safe Helm/P.Assist Setup] appears on the [Dockside Setup] menu after the helm sensor test is successfully completed.

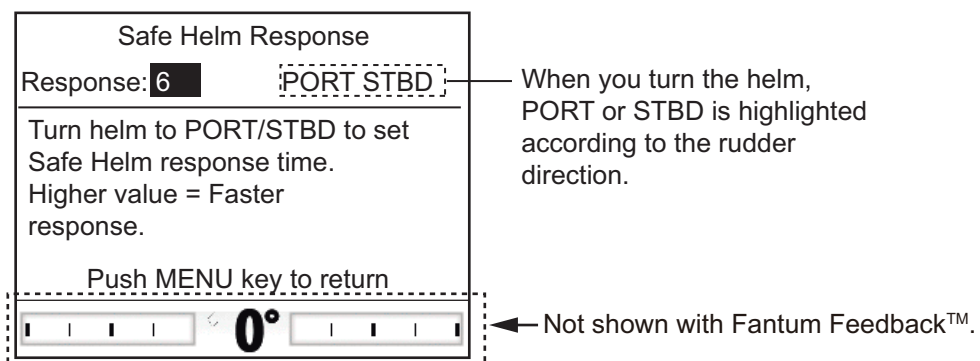

2. Rotate the **Course control** knob to select the current setting for [Safe Helm] then push the knob.
3. Rotate the **Course control** knob to select [ON] then push the knob to activate the safe helm.
4. Rotate the **Course control** knob to select the current setting value for [Return Delay] then push the knob.
5. Rotate the **Course control** knob to set a value for [Return Delay] then push the knob (setting range: 1-20 sec.).
 - **NAV mode:** When the data from the helm sensor is not input for the set time, NAV mode is restored.
 - **Other than NAV mode):** When cruising straight ahead and the data from the helm sensor is not input for the set time, the previous steering mode is restored.
6. Rotate the **Course control** knob to select [Safe Helm Response] then push the knob.



7. The cursor is selecting the current setting value for [Response]; push the **Course control** knob.
8. Rotate the **Course control** knob to select a value then push the knob (setting range: 1-10).
The higher the value the faster the response.
9. Press the  key to close the [Safe Helm Response] window.
10. Rotate the **Course control** knob to select the current setting for [Safe Helm Beep] then push the knob.
11. Rotate the **Course control** knob to select [ON] or [OFF] then push the knob.
[Safe Helm Beep] turns the beep on or off when the safe helm mode is activated.
12. Press the  key to close the [Safe Helm/P.Assist] menu.

Power assist setup (for Accu-Steer FPS 12V (or 24V) drive)

Perform the helm sensor test before doing the power assist setup. For details of the helm sensor test, see "Helm sensor test (for Accu-Steer FPS 12V (or 24V) drive)" on page 7-13.

1. Select [Safe Helm/P.Assist Setup] from the [Dockside Setup] menu then push the **Course control** knob.
[Safe Helm/P.Assist Setup] appears on the [Dockside Setup] menu after the helm sensor test is successfully completed.
2. Rotate the **Course control** knob to select the current setting for [Power Assist] then push the knob.

7. INITIAL SETTINGS

3. Rotate the **Course control** knob to select [ON] then push the knob to activate the power assist.
When this is done, the menu items for power assist appear.

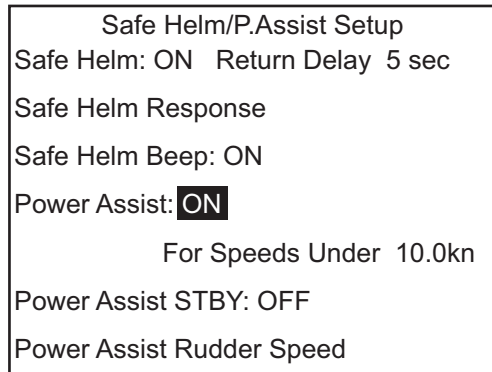

4. Rotate the **Course control** knob to select the current setting value for [For Speeds Under] then push the knob.
5. Rotate the **Course control** knob to set the highest speed at which power assist activates (setting range: 1.0-25.0 kn).
Note: When the power assist activates at high speed, the vessel may turn faster than intended. Set [For Speeds Under] according to the vessel and rudder feature.
6. Rotate the **Course control** knob to select the current setting for [Power Assist STBY] then push the knob.
7. If you want power assist in the STBY mode, select [ON] then push the **Course control** knob. If not, select [OFF].
8. Rotate the **Course control** knob to select [Power Assist Rudder Speed] then push the knob.

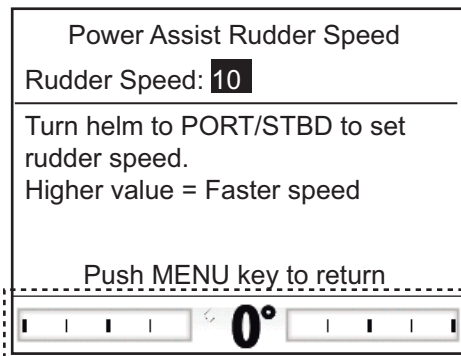

← Not shown with Fantum Feedback™.

9. The cursor is selecting the current setting value for [Rudder Speed]; push the **Course control** knob.
10. Rotate the **Course control** knob to select a value then push the knob (setting range: 1-10).
The higher the setting, the stronger the power assist.
11. Press the  key to close the [Safe Helm/P.Assist] menu.

7.4.4 Confirmation of the dockside setup

After entering the dockside setup, confirm that the dockside setup is completed correctly, and the safe helm and power assist features work properly.

When the rudder reference unit is installed

- Confirmation of the rudder limit setup
 1. Show the rudder angle indicator.
 2. Turn the helm hard-over to port at the dockside.
 3. Confirm that the rudder angle indicator shows the value set at [STBD Limit Setup].
 4. Turn the helm hard-over to starboard at the dockside.
 5. Confirm that the rudder angle indicator shows the value set at [PORT Limit Setup].
- Confirmation of the AUTO mode at the dockside
 1. Show the rudder angle indicator.
 2. Select the AUTO mode at the dockside.
 3. Rotate the **Course control** knob clockwise to set course.
 4. Confirm that the rudder turns to starboard with the rudder angle indicator.
 5. Rotate the **Course control** knob counterclockwise to set course.
 6. Confirm that the rudder turns to port with the rudder angle indicator.
- Confirmation of the AUTO mode at sea
 1. Select the safe area and cruise at low speed.
 2. Select the AUTO mode and confirm that NAVpilot controls the vessel properly.
- Helm sensor test

Note: Confirm that your boat carries the Accu-Steer FPS 12V (or 24V) drive unit.

 1. Select [Helm Sensor Test] from the diagnostic menu.
 2. Select [Yes] to start the helm sensor test.
 3. Center the rudder then push the **Course control** knob.
 4. Turn the helm to port or starboard, and then confirm that the steering direction at this step ("PORT" or "STBD") is shown at [Universal Input 1].
 5. Turn the helm to the opposite direction from step 4, and then confirm the steering direction at this step ("PORT" or "STBD") is shown at [Universal Input 2].
- Confirmation of the power assist feature activation

When [Power Assist] is set to [ON], do the following procedure.

 1. When [Power Assist STBY] is set to [ON], select the STBY mode. When [Power Assist STBY] is set to [OFF], select the AUTO mode.
 2. Turn the helm to port slowly, and then confirm that the power assist is activated and the rudder turns to port.
 3. Turn the helm to starboard slowly, and then confirm that the power assist is activated and the rudder turns to starboard.
- Confirmation of the safe helm and power assist features

When [Safe Helm] and [Power Assist] is set to [ON], do the following procedure.

 1. Select the safe area and cruise at minimum speed.

7. INITIAL SETTINGS

2. Select the AUTO mode.
3. Turn the helm and adjust the response at [Safe Helm Response].
4. While turning the helm, confirm that the power assist feature does not work too strongly. If necessary, adjust the value at [Power Assist Rudder Speed].
5. Center the rudder and stop steering. Then the steering mode is changed to the AUTO mode automatically. Adjust the return delay at [Return Delay].
6. Set the ship's speed to the value set at [For Speed Under].
7. Turn the helm, and then confirm that the safe helm and power assist feature activate correctly.
Note: Do not turn the helm rapidly. If the power assist feature works strongly, the vessel may turn faster than intended.
8. Turn the helm and adjust the response at [Safe Helm Response].
9. When it is difficult to cruise at the speed set at step 6, adjust the setting value at [For Speeds Under] so that you can control the vessel easily.

For Fantum Feedback™

- Confirmation of the rudder steering
 1. Select the AUTO mode at the dockside.
 2. Rotate the **Course control** knob clockwise to set course.
 3. Confirm visually that the rudder turns to starboard.
 4. Rotate the **Course control** knob counterclockwise to set course.
 5. Confirm visually that the rudder turns to port.
- Confirmation of the AUTO mode at sea
 1. Select the safe area and cruise at low speed.
 2. Select the AUTO mode and confirm that NAVpilot controls the vessel properly.
- Helm sensor test
Note: Confirm when you install the Accu-Steer FPS 12V (or 24V) drive unit.
 1. Select [Helm Sensor Test] from the diagnostic menu to start the helm sensor test.
 2. Center the rudder then push the knob to show the message.
 3. Turn the helm to port, and then confirm that "PORT" is shown at [Universal Input 1].
 4. Turn the helm to starboard, and then confirm that "STBD" is shown at [Universal Input 2].
- Confirmation of the power assist feature
When [Power Assist] is set to [ON], do the following procedure.
 1. When [Power Assist STBY] is set to [ON], select the STBY mode. When [Power Assist STBY] is set to [OFF], select the AUTO mode.
 2. Turn the helm to port slowly, and then confirm visually that the power assist is activated and the rudder turns to port.
 3. Turn the helm to starboard slowly, and then confirm visually that the power assist is activated and the rudder turns to starboard.
- Confirmation of the safe helm and power assist features
When [Safe Helm] and [Power Assist] is set to [ON], do the following procedure.

1. Select the safe area and cruise at minimum speed.
2. Select the AUTO mode.
3. Turn the helm and adjust the response at [Safe Helm Response].
4. While turning the helm, confirm that the power assist feature does not work too strongly. If necessary, adjust the value at [Power Assist Rudder Speed].
5. Center the rudder and stop steering. Then the steering mode is changed to the AUTO mode automatically. Adjust the return delay at [Return Delay].
6. Set the ship's speed to the value set at [For Speed Under].
7. Turn the helm, and then confirm that the safe helm and power assist feature activate correctly.

Note: Do not turn the helm rapidly. If the power assist feature works strongly, the vessel may turn faster than intended.
8. Turn the helm and adjust the response at [Safe Helm Response].
9. When it is difficult to cruise at the speed set at step 6, adjust the setting value at [For Speeds Under] so that you can control the vessel easily.

7.5 CAN bus Port Setup

The [CAN Bus Setup] menu sets up the equipment connected to the CAN bus port. To open the [CAN Bus Setup] menu, select [CAN Bus Setup] from the [Installation Menu] window.

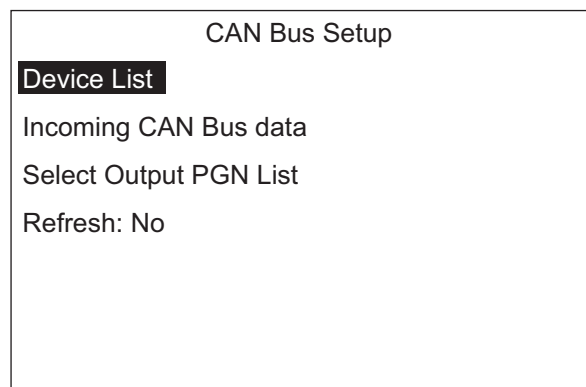

1. The cursor is selecting [Device List]; push the **Course control** knob. The [Device List] display shows the name of the CAN bus equipment connected to the CAN bus port. In the example illustration, the FURUNO heading sensor PG-700 is connected. The series of alphanumeric characters which follow the model name are the CAN bus unique number.
 
2. To change the device name, do the following. If you do not need to change the name, go to step 3.
 - 1) Push the **Course control** knob.
 - 2) Rotate the **Course control** knob to select character then push the knob.
 - 3) The cursor moves to the next character. Repeat step 2 to change the character. You can select the input location with the ◀ and ▶ keys. The name can have a maximum of 14 characters.

7. INITIAL SETTINGS

3. Press the  key to return to the [CAN Bus Setup] menu.
4. Rotate the **Course control** knob to select [Incoming CAN Bus data].

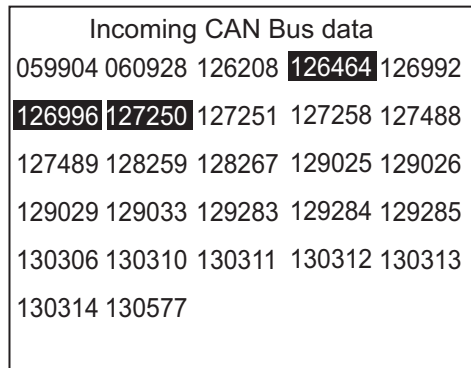

```
Incoming CAN Bus data
059904 060928 126208 126464 126992
126996 127250 127251 127258 127488
127489 128259 128267 129025 129026
129029 129033 129283 129284 129285
130306 130310 130311 130312 130313
130314 130577
```

This display shows all the NMEA 2000 sentences that the NAVpilot is capable of receiving. The Parameter Group Number (PGN) the NAVpilot is currently receiving are highlighted.

5. Press the  key to return to the [CAN Bus Setup] menu.
6. Rotate the **Course control** knob to select [Select Output PGN List] then push the knob.

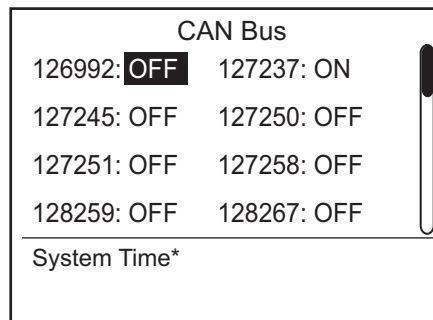

```
CAN Bus
126992: OFF 127237: ON
127245: OFF 127250: OFF
127251: OFF 127258: OFF
128259: OFF 128267: OFF
System Time*
```

*: The PGN title of the selected PGN is displayed.

This display shows all the NMEA 2000 PGNs that can be output to the connected NMEA 2000 network. The sentences selected for output show "ON". To turn a sentence ON or OFF, go to step 7. If you do not need to change the settings, go to step 8.

Note: Turn OFF the sentence "127245" (rudder) in case of Fantum Feedback™.

7. To turn an NMEA 2000 sentence ON or OFF, do the following:
 - 1) Rotate the **Course control** knob to select a sentence then push the knob.
 - 2) Rotate the **Course control** knob to select [ON] or [OFF] then push the knob.
8. Press the  key to return to the [CAN Bus Setup] menu.
9. Rotate the **Course control** knob to select the option for [Refresh] then push the knob.
10. Rotate the **Course control** knob to select [Yes] then push the knob. After five seconds, the [Devise List] display is refreshed.

7.6 NMEA0183 Port Setup

The [NMEA0183 Setup] menu sets the NMEA0183 port according to the equipment connected to the port. To open the [NMEA0183 Setup] menu, select [NMEA0183 Setup] from the [Installation Menu] window.

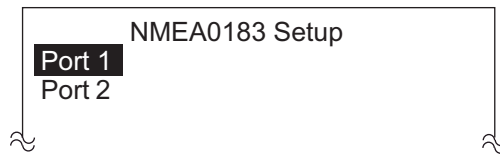

Note: [Port2] is not shown when [Boat Type] is set to [EVCS boat].

1. The cursor is selecting [Port1]; push the **Course control** knob.

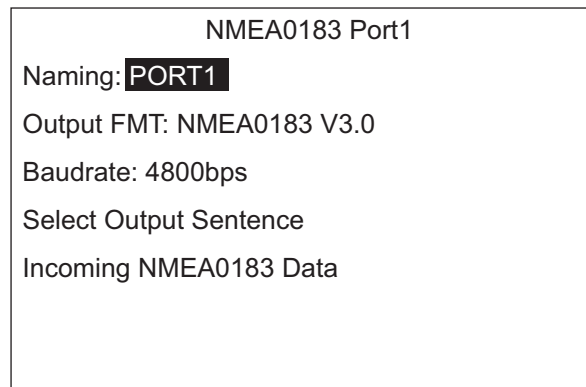

2. The cursor is selecting the current name for [Naming]. This menu item lets you change the name of the port. For example, equipment type, model number, etc. The name can have a maximum of 14 alphanumeric characters. If you don't need to change the name, go to step 3.
 - 1) Push the **Course control** knob.
 - 2) Rotate the **Course control** knob to select character then push the knob.
 - 3) The cursor moves to the character. Repeat step 2 to change the character.
You can select the input location with the ◀ and ▶ keys.
3. Rotate the **Course control** knob to select the current setting for [Output FMT] then push the knob.
4. Rotate the **Course control** knob to select the output format of the equipment then push the knob.
5. Rotate the **Course control** knob to select the current value for [Baudrate] then push the knob.
6. Rotate the **Course control** knob to select the baud rate of the equipment then push the knob.

NMEA0183 V1.5
NMEA0183 V2.0
NMEA0183 V3.0

4800bps
38400bps

7. INITIAL SETTINGS

7. Rotate the **Course control** knob to select [Select Output Sentence] then push the knob.

One of the following displays appear depending on the NMEA output format selected.

Ver 1.5		
DBT: OFF	GGA: OFF	GLL: OFF
HDM: OFF	HDT: OFF	MTW: OFF
RMB: OFF	RMC: OFF	ROT: OFF
VHW: OFF	VTG: OFF	VWR: OFF
VWT: OFF	ZDA: OFF	

Ver 2.0		
DBT: OFF	DPT: OFF	GGA: OFF
GLL: OFF	HDG: OFF	HDT: OFF
MTW: OFF	MWV: OFF	RMB: OFF
RMC: OFF	ROT: OFF	RSA: OFF
VHW: OFF	VTG: OFF	ZDA: OFF

Ver 3.0		
DBT: OFF	DPT: OFF	GGA: OFF
GLL: OFF	GNS: OFF	HDG: OFF
HDT: OFF	MTW: OFF	MWV: OFF
RMB: OFF	RMC: OFF	ROT: OFF
RSA: OFF	VHW: OFF	VTG: OFF
ZDA: OFF		

8. To turn a sentence ON or OFF, do the following;
- Note:** Turn OFF the sentence “RSA” (rudder) in case of Fantum Feedback™.
- 1) Rotate the **Course control** knob to select the sentence then push the knob.
 - 2) Rotate the **Course control** knob to select [ON] or [OFF] then push the knob.
9. Press the  key to return to the [NMEA0183 Port1] menu.
10. Rotate the **Course control** knob to select [Incoming NMEA0183 Data] then push the knob.

Incoming NMEA0183 Data					
AAM	DBT	HDG	RMB	VHW	ZDA
APB	DPT	HDM	RMC	VTG	
BOD	GGA	HDT	ROT	VWR	
BWC	GLL	MTW	THS	VWT	
BWR	GNS	MWV	TLL	XTE	

This display shows the NMEA0183 sentences currently being received.

11. Press the  key twice to return to the [NMEA0183 Port Setup] menu.
If you have equipment connected to the NMEA0183 port 2, set up the equipment similar to how you set up the equipment in the NMEA0183 port 1.
- Note:** [Port2] is not shown when [Boat Type] is set to [EVCS boat].

7.7 Data Source Setup

The [Sensor Selection] menu selects the data source. To open the [Sensor Selection] menu, select [Sensor Selection] from the [Installation Menu] window.

Before doing this procedure, turn on all CAN bus equipment connected to the CAN bus network of the NAVpilot.

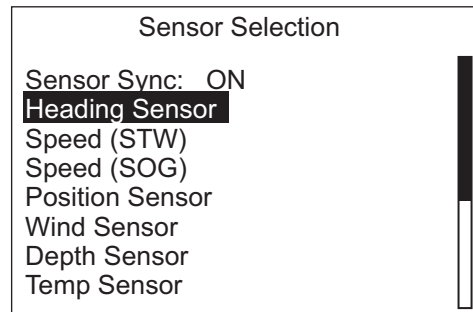

Sensor sync

When NavNet3 or NavNet TZtouch devices are connected to the same network with the NAVpilot, the sensors connected to NavNet3 or NavNet TZtouch devices are available for the NAVpilot. Do as follows to share the sensors:

1. The cursor is selecting the current setting for [Sensor Sync]; push the **Course control** knob.
2. Rotate the **Course control** knob to select [ON] or [OFF] then push the knob. When [Sensor Sync] is set to [ON], the sensors connected to NavNet3 or NavNet TZtouch devices are available for the NAVpilot.

Data source selection

Do as follows to select the data source.

1. Turn on all sensors connected to the NAVpilot.
2. Select the appropriate data to set the data source, then push the **Course control** knob.

The following display example is when [Heading Sensor] is selected.

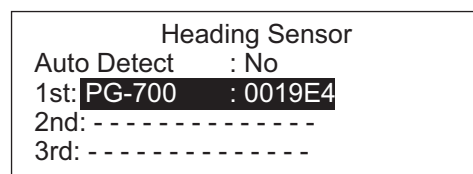

When [Auto Detect] is selected to [Yes], the NAVpilot automatically detects and connects to data sources within the network. In case of multiple heading sensors, the sensors are prioritized in the order of FURUNO CAN bus heading sensor, other CAN bus heading sensor, NMEA0183 heading sensor. After detecting sensors, [Auto Detect] changes to [No] from [Yes]. If desired, you can change the data source priority as follows:

- 1) Rotate the **Course control** knob to select the number then push the knob.
- 2) Rotate the **Course control** knob to select a sensor then push the knob.

7.8 Universal Port Setup



The [Universal Port] menu sets up the GENERAL IN and GENERAL OUT ports. To open the [Universal Port] menu, select [Universal Port] from the [Installation Menu] window.

GENERAL IN: A switch box is connected to this port to control the NAVpilot from a remote location.

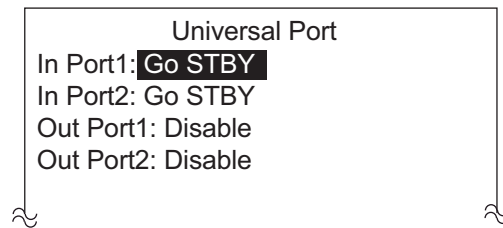
GENERAL OUT: A buzzer sounds or a lamp lights at a remote location when the specified function is done on the NAVpilot.



7.8.1 GENERAL IN port setup

1. The cursor is selecting the current setting for [In Port]; push the **Course control** knob.
2. Rotate the **Course control** knob to select the command or function for a switch box connected to the port.
 - [Disable]: The port is disabled.
 - [AP Enable]: Set the switch to ON to get full control of the boat with the NAVpilot. The OFF position provides only the STBY mode functions.
 - [Go STBY] (default setting): The switch, when operated, puts the NAVpilot in the STBY mode.
 - [Go AUTO]: The switch, when operated, puts the NAVpilot in the AUTO mode.
 - [PORT Arrow Key]: The switch, when operated, controls the  key on the NAVpilot.
 - [STBD Arrow Key]: The switch, when operated, controls the  key on the NAVpilot.
 - [Net Towing AUTO]: The switch, when operated, enables the automatic towing function when a boat is towing fishing gear. This menu item is not available in the following cases.
 - For a sailboat or Fantum Feedback™
 - When [Net Towing AUTO] is set to [ON] in the menu for each mode or [AUTO Option] menu.
 - [Function Key]: Assign function of equipment connected to the NAVpilot.

3. If you selected [Function Key], do the following to select a function. If not, go to step 4.
 - 1) Rotate the **Course control** knob to select the current setting for [Function Key] then push the knob.

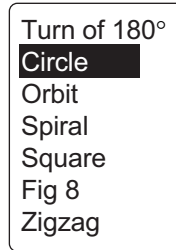

For Fantum Feedback™, only [Turn of 180°] is selective.

- 2) Rotate the **Course control** knob to select a turn then push the knob.
 - 3) Rotate the **Course control** knob to select the current setting for [PORT/STBD] then push the knob.
 - 4) Rotate the **Course control** knob to select the direction of the turn then push the knob.
4. If you have another device connected to the UNIVERSAL IN port, set it up at [In Port 2].

7.8.2 GENERAL OUT port setup

1. Rotate the **Course control** knob to select the current setting for [Out Port1] then push the knob.
2. Rotate the **Course control** knob to select the action that triggers an external buzzer or lamp then push the knob.
A lamp lights or an external buzzer sounds when;
 - [EXT Buzzer]: The [Buzzer] setting on the [Alarm] menu is automatically set to [Internal+External].
 - [STBY Mode]: Manual mode.
 - [AUTO Mode]: AUTO mode.
 - [NAV Mode]: NAV mode.
 - [AUTO/NAV Mode]: AUTO or NAV mode.
 - [AP Control]: Operating mode where the NAVpilot controls the rudder.
 - [PORT Arrow Key]: The PORT arrow key (◀) is operated.
 - [STBD Arrow Key]: The STBD arrow key (▶) is operated.
 - [Disabled]: Function disabled.
3. If you have another device connected to the UNIVERSAL OUT port, set it up at [Out Port2].

7.9 Sea Trial

According to the presence or absence of the rudder reference unit, the menu items on the [Sea Trial] menu change. To open the [Sea Trial] menu, select [Sea Trial] from the [Installation Menu] window.

When the rudder reference unit is installed

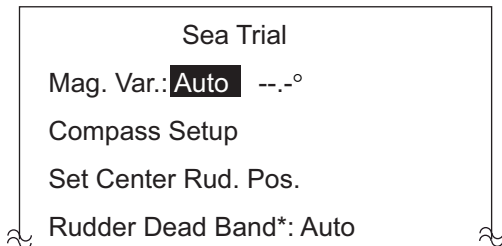

When the rudder reference unit is not installed

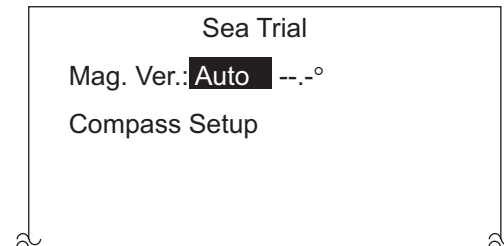

*: Set [Auto] to do rudder test.
Set [Manual] to adjust rudder deadband.

Setting for [Mag. Var/]

With a magnetic heading sensor (PG-500/PG-700, etc.), magnetic variation information is necessary to display true heading data. In almost all cases, a GPS will be connected to the NAVpilot and the GPS will send this variation information to the NAVpilot automatically. Therefore, set [Mag. Var.] to [Auto]. In special cases where a manual variation is required, you may input these values manually. Note that this selection is only effective when [Heading Display] is set to [True] on the [Display Setup] menu.

When [Heading Display] is set to [True] on the [Display Setup] menu, the NAVpilot will display true heading information even though the NAVpilot may be connected to a magnetic heading sensor. This is very valuable when connecting a FURUNO FAR-21x7 series radar to the NAVpilot because these radars can not be set for a magnetic heading input and the "Waypoint Lollipop" will only align properly when true heading is used.

7.9.1 How to calibrate the compass (PG-500/PG-700)

If you have selected the FURUNO PG-500/PG-700 as a heading sensor, do the procedure below to calibrate the compass and get automatic distortion compensation.

- This procedure is not applicable to heading sensors other than PG-500/PG-700.
- It is not necessary to perform any adjustments locally at the PG-500/PG-700. NAVpilot has full control of these heading sensors.

1. Rotate the **Course control** knob to select [Compass Setup] from the [Sea Trial] menu then push the knob.

Compass Setup	
Select Compass:	1st
Compass Calib.:	NO
Auto Calib. Update:	ON
Compass Offset :	E 0.0°
Restart PG-700*	
Compass Clear:	NO* ²
Compass Information	
COG - - -°	HDG: T178°

*1: Appears with connection of PG-700. Restarts PG-700. Turn the steering mode to the STBY mode to restart PG-700.

*2: Appears with connection PG-500/PG-700. Restore sensor's factory defaults. For recalibrating compass.

2. Confirm that the cursor is selecting [1st] at [Select Compass]. Calibrate the 1st compass and then calibrate others.
 - 1) Rotate the **Course control** knob to select the current setting for [Compass Calib.] then push the knob.

No
Auto*
Manual

*: Not shown with Fantum Feedback™.

- 2) Rotate the **Course control** knob to select [Auto] or [Manual] then push the knob.

[Auto]: The boat turns to starboard about three or four full circles for calibration. Note that the boat will turn to starboard with the degree set at [Manual Rudder Limit] on the [Dockside Setup] menu. For the EVC system equipped boats, the boat will turn to starboard with 26°.

[Manual]: Use the helm to turn the boat to port or starboard for three or four full circles in a speed of about one minute/circle to perform the calibration.
- 3) Push the **Course control** knob to start the calibration.

For [Auto], the boat starts to turn to starboard, and then the calibration starts automatically. For [Manual], turn the boat to starboard or port in a circular course. Cruise in a speed of about one minute/circle.

 - To stop the calibration while the ship is turning, press any key to show the message "Calibration stopped. Please retry.". Press any key to return to the [Sea Trial] menu.
 - When the calibration is successfully completed, the message "Calibration completed." appears. Press any key to return to the [Sea Trial] menu.
 - If the calibration failed, the message "Calibration not completed. Retry calibration." appears. Push the **Course control** knob to retry the calibration, or press any key to return to the [Sea Trial] menu.
- 4) Rotate the **Course control** knob to select the current setting for [Auto Calib. Update] then push the knob.
- 5) Rotate the **Course control** knob to select [ON] then push the knob. The AUTO LED lights on the PG-500.

7. INITIAL SETTINGS

3. If you have another PG-500/PG-700, select it at [Select Compass] and calibrate it following the above procedure.
4. If the heading data shown on the control unit differs from the indication of the ship's compass, apply an offset at [Compass Offset]. This offset is applied to the heading sensor data. For example, if the control unit display shows 125° though the ship's compass reading is 120°, enter "5".
 - 1) Rotate the **Course control** knob to select the current setting value for [Compass Offset] then push the knob.
 - 2) Rotate the **Course control** knob to set a value then push the knob (setting range: E 0.0°-E 180.0°, W 0.0°-W 179.9°).
5. Rotate the **Course control** knob to select [Compass Information] then push the knob.

The [Compass Information] display show the name and software version of the compass connected to the NAVpilot.

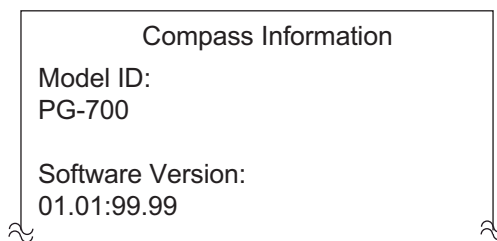

6. Press the  key twice to return to the [Compass Setup] menu.
7. Rotate the **Course control** knob to select [Set Center Rud. Pos.] then push the knob.

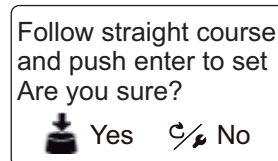

You must set the rudder position at 0° on the [Sea Trial] menu. If this setting is not completed, the boat may wander. For dual-engine boats, be sure that the engines are synchronized and maintain a normal cruising speed.

8. Run the boat between 10 and 15 knots.
9. When the ship runs straight, push the **Course control** knob to set.

7.9.2 How to set the rudder deadband

Set the rudder deadband automatically or manually.

1. Rotate the **Course control** knob to select the current setting for [Rudder Deadband] from the [Sea Trial] menu then push the knob.
2. Rotate the **Course control** knob to select [Manual] or [Auto] then push the knob.
3. For [Manual], do as follows:
 - 1) Rotate the **Course control** knob to select the current value for [Rudder Deadband] then push the knob.
 - 2) Rotate the **Course control** knob to set a value then push the knob.

Note: When the rudder test is performed after setting the rudder deadband manually, set the rudder deadband again.

7.10 Data Calibration

The [Data Calibration] menu lets you apply an offset to speed, wind, temperature and depth data. To open the [Data Calibration] menu, select [Data Calibration] from the [Installation Menu] window.

If the indication on the control unit differs from actual value, apply an offset to correct the indication. Current indications on the control unit appear in parentheses.

Data Calibration	
STW:	0° % (--- kn)
Wind ANG:	0.0° (---.- °) A
Wind SPD:	0.0kn (--- kn) A
	0%
Temp:	0°F (---.- °F)
Depth:	0ft (--- ft)

1. Rotate the **Course control** knob to select the sensor you want to compensate from the [Data Calibration] menu then push the knob.
2. Rotate the **Course control** knob to set a value then push the knob. Enter a negative value when the indication is higher than the actual value; a positive value when it is lower than the actual value. For example, if the depth indication is 100 feet and the actual depth is 98 feet, enter “-2”.

Item	Range of compensation	Item	Range of compensation
[STW]*	-50 - +50 (%)	[Temp]	-10 - +10 (°C), -18 - +18 (°F)
[Wind ANG]	-180.0 - +180.0 (°)	[Depth]	-15 - +100 (ft/m/fa/PB)
[Wind SPD]	-5 - +5 (kn, km/h, m/s, mph) or -50 - +50 (%)		

7.11 Parameter Setup Menu

The various parameters for your NAVpilot are set up from the [Parameter Setup] menu. To open the [Parameter Setup] menu, select [Parameter Setup] from the [Installation Menu] window.

Parameter Setup	
Sea State:	Full-Auto
Deviation Level:	Auto
Manual Parameter	
Trim Gain*:	Auto
Speed Calculation:	Auto

*: Not shown with Fantum Feedback™.

7.11.1 Sea state

How to select NAVpilot steering parameters

Your NAVpilot has two types of steering features for parameter adjustment:

- **Automatic adjustment feature:** Sets up the equipment according to ship's characteristics and sea state, for optimum performance in the AUTO, NAV and WIND modes.
- **Self-learning feature:** Adjusts parameters for rudder ratio, counter rudder and auto trim gains are constantly optimized based on the steering history of your boat, and are stored in memory for future navigation.

1. Rotate the **Course control** knob to select the current setting for [Sea State] from the [Parameter Setup] menu then push the knob.
2. Rotate the **Course control** knob to select the option which best matches current sea state then push the knob.

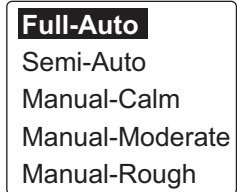

- [Full-Auto]: Auto adjustment and self-learning are on.
- [Semi-Auto]: Auto adjustment is on, self-learning is off.
- [Manual-Calm]: Self-learning is off, using the parameter selected for calm sea.
- [Manual-Moderate]: Self-learning is off, using the parameters for a typical normal sea state.
- [Manual-Rough]: Self-learning is off, using preset parameters for a typical rough sea state.

For normal, everyday operation, the [Full-Auto] mode is recommended. However, if you want the NAVpilot to steer the boat based on experience-related parameters, but you don't want the pilot to be in "self-learning" mode, select the [Semi-Auto].

Note: The course keeping accuracy may decrease if the sea state is different from the experience-related parameters. This option is provided if you happen to be using the pilot in a situation that you do not anticipate encountering again.

3. For [Full-Auto], set the deviation level as follows:
 - 1) Rotate the **Course control** knob to select the current setting for [Deviation Level] then push the knob.
 - 2) Rotate the **Course control** knob to select [Auto] or [Level].
For [LEVEL], you may set a value between 1 and 9. A lower number keeps the course more precisely but the rudder may be turned more often. With a higher number, the rudder is fixed, but the course may not be kept as precisely.



How to manually set NAVpilot steering parameters

When [Manual-Calm], [Manual-Moderate] or [Manual-Rough] is selected as the sea state, set [Manual parameter] as below.

You can set three parameters for the manual function: [Weather], [Rudder Gain] and [Counter Rud.].

1. Rotate the **Course control** knob to select [Manual Parameter] from the [Parameter Setup] menu then push the knob.
The display as shown below appears.

Manual Parameter			
	Calm	Moderate	Rough
Weather	1°	2°	3°
Rudder Gain	3	5	10
Counter Rud.	1	2	4

2. Rotate the **Course control** knob to select the current setting value of [Weather]-[Calm] then push the knob.
3. Rotate the **Course control** knob to set a value (setting range: 0° to 10°) to push the knob.
4. Set [Weather-Moderate], [Weather-Rough] similarly.
5. Set [Rudder Gain] and [Counter Rud.] similarly.
Setting range: 1-20 for [Rudder Gain], and 0-20 for [Counter Rud.]

Guidelines for how to set [Sea State]

[Weather]: When the sea is rough, the boat's heading fluctuates to port and starboard. If the rudder is driven very often to maintain the set course, the helm mechanism may wear out. To prevent this, the weather adjustment makes the NAVpilot insensitive to minute course deviations. You may choose a degree between 1° to 10°. Until the course deviation exceeds the selected setting, steering to correct the heading will not be initiated.

The illustration at the top of the next page shows boat's track lines with weather setting 3° and 7°. When 7° is set, for example, the rudder is not driven until the course deviation exceeds 7°. Increasing the setting reduces activation of the steering gear, however the boat tends to zigzag. When the sea is calm, set a smaller value.

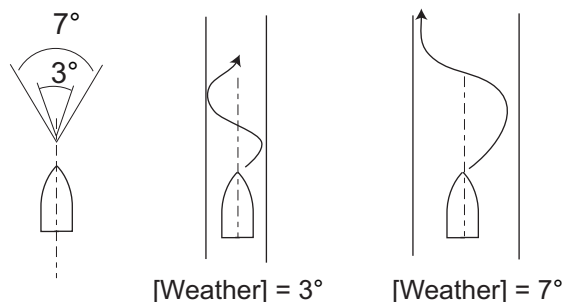

[Rudder Gain]: When the boat's heading deviates from the set course, the NAVpilot adjusts the rudder to correct it. The rudder angle (number of degrees) which is steered against every degree of course deviation is known as the rudder gain.

Set the rudder gain so that the boat does not make frequent yaw. The figure shown below provides general guidelines for setting the rudder gain.

7. INITIAL SETTINGS

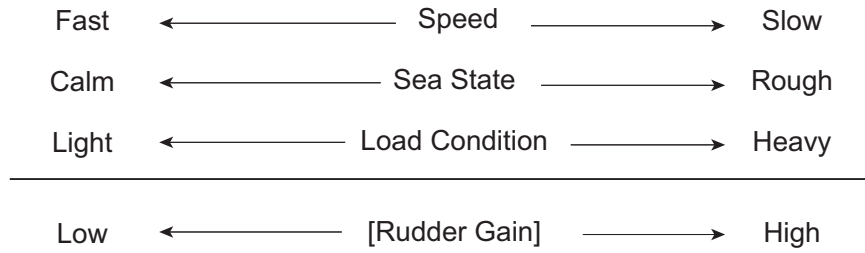

[Counter Rud.]: If the boat is heavily loaded, the heading could change excessively because of inertia. This phenomenon causes the vessel to "overshoot" the intended course. If this happens, the NAVpilot will steer the rudder to the opposite side and the heading will turn in the opposite direction excessively again. In an extreme case the heading oscillates several times until it finally settles in the new course. An adjustment known as "counter rudder" prevents this kind of oscillation.

Counter rudder is usually not required for small boats. When your boat zigzags a lot before settling in the new course, increase the counter rudder setting.

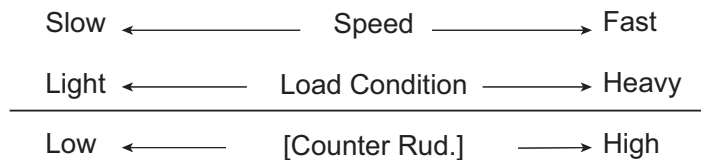
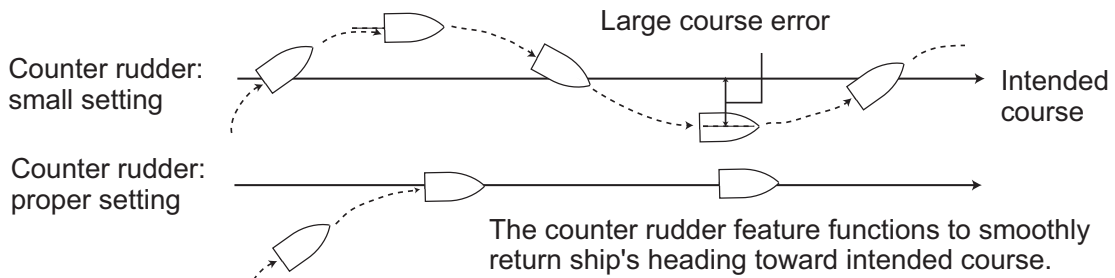

7.11.2 Trim gain

The NAVpilot continually monitors the boat's trim in order to keep the trim sensitivity optimum. A lower setting is common because boat's trim usually does not change quickly. A large number changes the trim compensation value more frequently. Too high of a setting may result in the following problems.

- Trim sensitivity is over-affected, resulting that a trim appears in both port and starboard directions alternately.
- Trim compensation mechanism responds to the yawing, resulting in more serious oscillation of ship's heading.

Note: Trim gain is not available with Fantum Feedback™.

To automatically set the trim, do as follows:

1. Rotate the **Course control** knob to select the current setting for [Trim Gain] from the [Parameter Setup] menu then push the knob.
2. Rotate the **Course control** knob to select [Auto] or [Manual] then push the knob.

3. For [Manual], do as follows:
 - 1) Rotate the **Course control** knob to select the current setting value and push the knob.
 - 2) Rotate the **Course control** knob to set a value then push the knob (setting range: 1 to 20).
The default value is automatically calculated according to length of your boat, entered on the [Ship's Characteristics] menu.

7.11.3 Speed calculation

Speed is normally entered automatically, from your navigator. If the navigator fails, manually enter speed.

1. Rotate the **Course control** knob to select the current setting for [Speed Calculation] from the [Parameter Setup] menu then push the knob.
2. Rotate the **Course control** knob to select [Auto] or [Manual] then push the knob.
3. For [Manual], do as follows:
 - 1) Rotate the **Course control** knob to select the current setting value then push the knob.
 - 2) Rotate the **Course control** knob to set a value then push the knob (setting range: 0.1 - 99.0).

7.12 AUTO Option Menu

The various features for the AUTO mode are set up from the [AUTO Option] menu. To open the [AUTO Option] menu, select [AUTO Option] from the [Installation Menu] window.

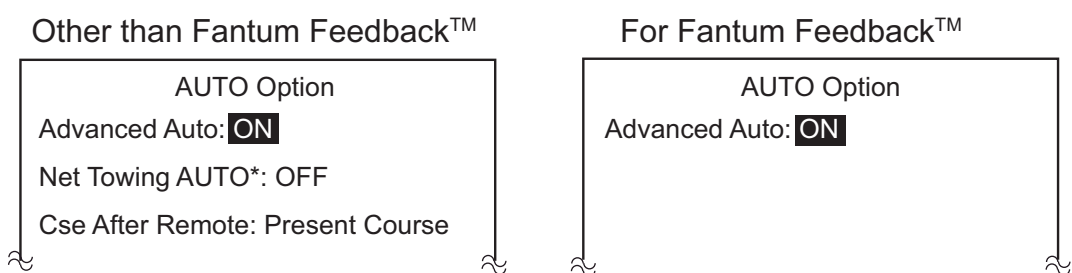

*: Not shown with a sailboat.

Item	Description	Settings
[Advanced AUTO]	The AUTO mode will maintain a set course, but your vessel's course may be shifted by the effects of tide and wind. To compensate for the effects of tide and wind, set [Advanced AUTO] to [ON]. Your NAVpilot must be connected to a GPS navigator which outputs position data (Latitude and Longitude) in CAN bus or NMEA0183 format.862	[OFF], [ON]

7. INITIAL SETTINGS

Item	Description	Settings
[Net Towing AUTO]	When a boat is towing fishing gear its stern is “dragged” by the net. This causes the boat to stray from its intended course. To keep the boat on course, your need to adjust the trim manually, which can be bothersome. If you do not want to be bothered with trim adjustments, your can enable the automatic towing function to have the trim automatically adjusted. This feature is useful for trawlers and purse seiners. This feature is not available for a sailboat or Fantum Feedback™.	[OFF], [ON]
[Cse After Remote]	Select the course to follow after a remote controller is operated. [Cse After Remote] is not shown in case of Fantum Feedback™.	[Previous Course], [Present Course]

7.13 NAV Option Menu

The various features for the NAV mode are set up from the [NAV Option] menu. To open the [NAV Option] menu, select [NAV Option] from the [Installation Menu] window.

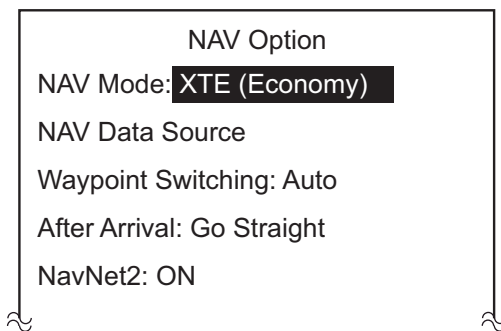

Item	Description	Settings
[NAV Mode]	Your vessel may go off course when navigating between waypoints in the NAV mode. This can happen when, for example, a command is received from a remote controller. To get you back on course, three methods are available [Course], [XTE (Precision)] and [XTE (Economy)]. For [Course], the NAVpilot calculates a new course based on your new position after dodging, etc. that takes you directly to your destination waypoint. [XTE (Precision)] and [XTE (Economy)] both use the XTE (cross-track error) value to steer the boat towards your original course before dodging. [XTE (Precision)] provides for more precise steering than [XTE (Economy)]. Note: [Course] is not shown in case of Fantum Feedback™.	[Course] [XTE (Precision)] [XTE (Economy)]
[NAV Data Source]	Select the source of nav data to use in the NAV mode. For how to select the source, see section 7.13.1.	

Item	Description	Settings
[Waypoint Switching]	When you arrive at a waypoint on a route in the NAV mode, you can switch to the next waypoint automatically or manually. The [Auto] setting will automatically switch to the next destination waypoint when your boat is within the arrival alarm area (set on the chart plotter). The [Manual] setting requires operator confirmation (pushing the knob) before switching to the next waypoint.	[Auto], [Manual]
[After Arrival]	Set how the boat is to be steered after arriving at the last waypoint in a route, in the NAV mode. This function is not available when boat type is selected as sail boat. Note: For Fantum Feedback™, only the items [Go Straight] and [Orbit to STBD] are available.	[Go Straight] [Orbit to PORT] [Orbit to STBD] [Figure Eight to PORT] [Figure Eight to STBD,] [Square PORT] [Square STBD]
[NavNet2]	The NAVpilot can automatically go to the NAV mode when it receives a P sentence (FURUNO proprietary) from a NavNet vx2 equipment. You can turn this feature on or off. This feature is disabled in the FishHunter™ mode.	[OFF] [ON]

7.13.1 How to select the source for nav data

Select the source of nav data to use in the NAV mode from the [NAV Option] menu.

1. Rotate the **Course control** knob to select [Nav Data Source] from the [NAV Option] menu then push the knob.

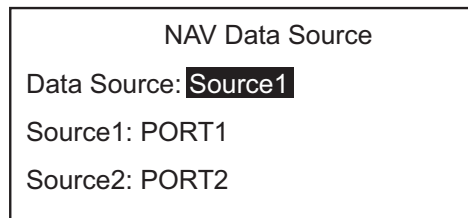

2. Rotate the **Course control** knob to select the current setting for [Data Source] then push the knob.

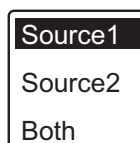

3. Rotate the **Course control** knob to select data source then push the knob. If you have more than one source of nav data, you can select [Both]. In this case, the nav data fed by [Source2] is used when that of [Source1] is not available.

Note: If you have NavNet vx2 equipment connected and it is synchronized with the NAVpilot ([NavNet2] turned on in the [NAV Option] menu, [Source2] is automatically selected.

4. Rotate the **Course control** knob to select [Source1] then push the knob.



7. INITIAL SETTINGS

If you have some equipment which outputs nav data, the name appears in the window. In the example above, a NavNet3 equipment, with the unique number of 000C2F, is connected.

*: Not shown when [Boat Type] = [EVCS Boat].

5. Rotate the **Course control** knob to select source then push the knob.
6. If you have more than one device that outputs nav data, you can select it at [Source2].

7.14 Fish Hunter Option Menu

You can set the parameters for the FishHunter™ turns on the [Fish Hunter Option] menu. To open the [Fish Hunter Option] menu, select [Fish Hunter Option] from the [Installation Menu] window.

Note: The [Fish Hunter Option] menu is not shown with a sailboat and Fantum Feedback™.

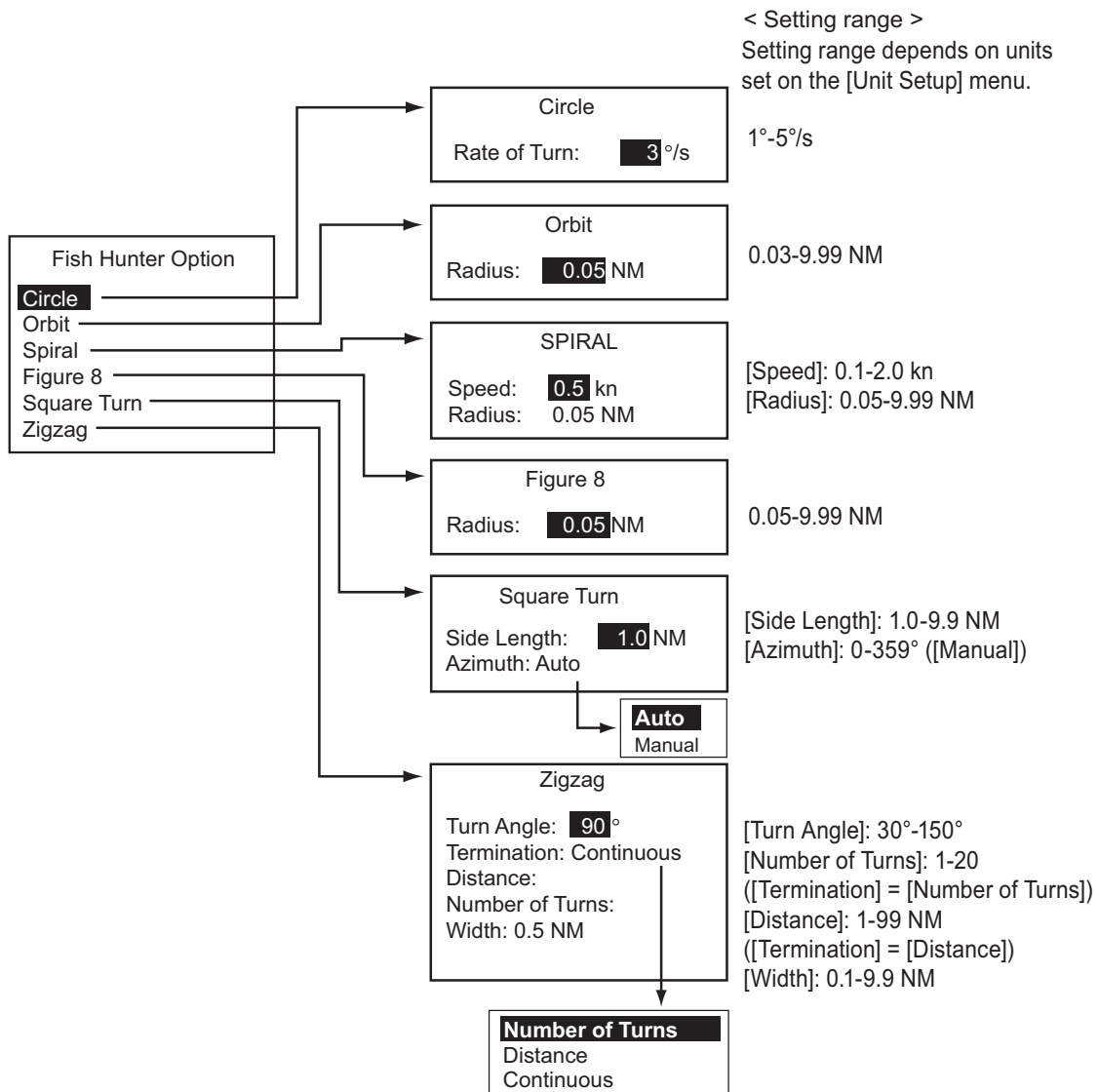

7.15 Wind Option Menu

You can set the parameters for the WIND mode on the [Wind Option] menu. To open the [Wind Option] menu, select [Wind Option] from the [Installation Menu] window.

Wind Option	
Mode Type:	AWA
Wind Tack Rud Angle:	35°
Wind Damping:	OFF
Fixed Tack Angle:	20°
Rate of Slow Tack:	3°/s
Rate of Fast Tack:	20°/s
Tack Timer:	OFF

Item	Description	Settings
[Mode Type]	There are two wind angle modes: AWA (Apparent Wind Angle) and TWA (True Wind Angle). [AWA]: The direction (in relation to ship's bow) of the wind as it appears on board your boat, detected by the wind sensor. AWA mode requires wind angle and speed data. Use this mode when the wind is stable. [TWA]: The actual wind direction, which is a combination of the apparent wind and your boat's movement. This mode requires apparent wind angle, apparent wind speed, your boat's speed and heading. Use this mode when there is an unstable downwind.	[AWA] [TWA]
[Wind Tack Rud Angle]	The tacking in the WIND mode requires the setting of maximum rudder angle. If you need to change the value, do it here.	10° - 45°
[Wind Damping]	You can set the damping interval for wind data to compensate for random fluctuation in wind data. The higher the setting the more "smooth" the data. However a high damping interval causes delay in receiving wind data, the amount of delay equivalent to the damping interval. Turn off wind damping if the wind data is received stably. This option is effective for port and starboard wind angles of 55° or higher and [Mode Type] is selected to [AWA].	[OFF] [ON] (0.7 - 99.9)
[Fixed Tack Angle]	The fixed tacking mode requires the setting of tacking angle.	15° - 179°
[Rate of Slow Tack]	Set the rate of slow tack.	1° - 10°/s
[Rate of Fast Tack]	Set the rate of fast tack.	1° - 30°/s
[Tack Timer]	Set the amount of time wait before starting a turn, after pushing the knob.	[OFF] [ON] (1 - 99 (sec))

7.16 System Setup Menu

The [System Setup] menu sets system settings such as key beep, panel dimmer, etc. To open the [System Setup] menu, select [System Setup] from the [Installation Menu] window.

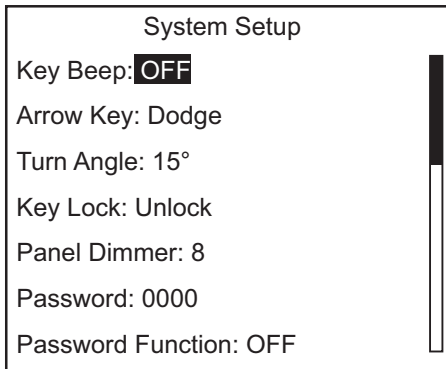

Note: The [Password] and the [Password Function] are not available when the version of the control unit is as below.
 •NAVpilot-711C: Ver.01.11 or later.

Menu items on the [System Setup] menu

For menu items other than the items below, see section 4.8.

- **[Save Eng Setting]:** Save the settings in the menus with the following exceptions:
 - [Display Setup] menu (except [Data Box Format])
 - [Dockside Setup] menu (except [Select RRU Type], [RRU Sensor Alignment], [Air Bleeding], [Rudder Limit Setup], [Rudder Test], [Helm Sensor Test])
 - [CAN Bus Setup] menu (except [Incoming CAN Bus Data], [Refresh])
 - [NMEA0183 Setup] menu
 - [Sensor Selection] menu (except [Auto Detect])
 - [System Setup] menu (except [Key Beep], [Key Lock], [Panel Dimmer], [Receive Screen], [All Clear], [Save/Load User Settings], [Save/Load Eng Setting], [Diagnostic], [Display Data Select Menu], [System Data])
- **[Load Eng Setting]:** Load the settings saved with [Save Eng Setting].
- **[Restore Factory Setting]:** Restores all default settings.

7.17 RC (Remote Controller) Setup Menu

The [RC Setup] menu sets the type of remote controller connected to the NAVpilot. To open the [RC Setup] menu, select [RC Setup] from the [Installation Menu] window.

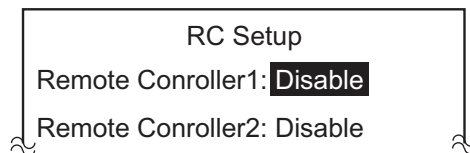

Note: The [RC Setup] menu is not shown in case of Fantum Feedback™.

1. The cursor is selecting the current setting for [Remote Controller1]; push the **Course control** knob.

2. Rotate the **Course control** knob to select the type of remote controller connected then push the knob.
[NFU]: Select for lever-type remote controller.
[FU]: Select for dial-type remote controller
[Dodge]: Select for dodge-type remote controller.
[Disable]: Disable remote controller operation.
3. Set the type for [Remote Controller2], if connected.

7.18 All Clear (Default Setting)

The all clear feature restores all default settings.

1. In the STBY mode, push the **Course control** knob three times while pressing the  key.
The [Installation Menu] window appears.
2. Rotate the **Course control** knob to select [System Setup] then push the knob.
3. Rotate the **Course control** knob to select the option for [Restore Factory Setting] then push the knob.
4. Rotate the **Course control** knob to select [Yes] then push the knob.

7. INITIAL SETTINGS

This page is intentionally left blank.

APPX. 1 MENU TREE

Menu in STBY mode

Long press the  key in the STBY mode

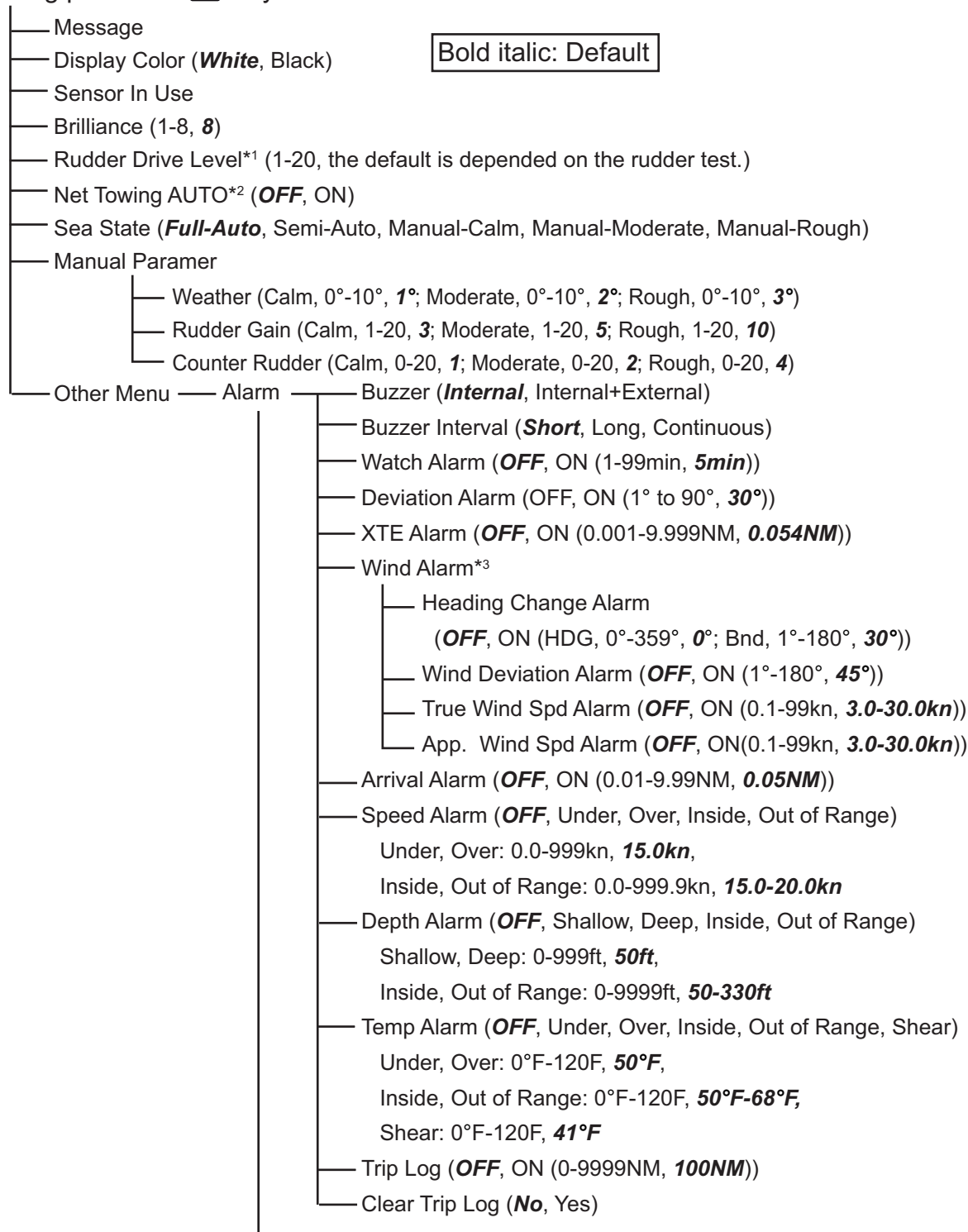

(Continued on next page)

*1: Shown with Fantum Feedback™.

*2: Not shown when [Boat Type] = [Sailboat] or in case of Fantum Feedback™.

*3: Shown when [Boat Type] = [Sailboat].

(Continued from previous page)

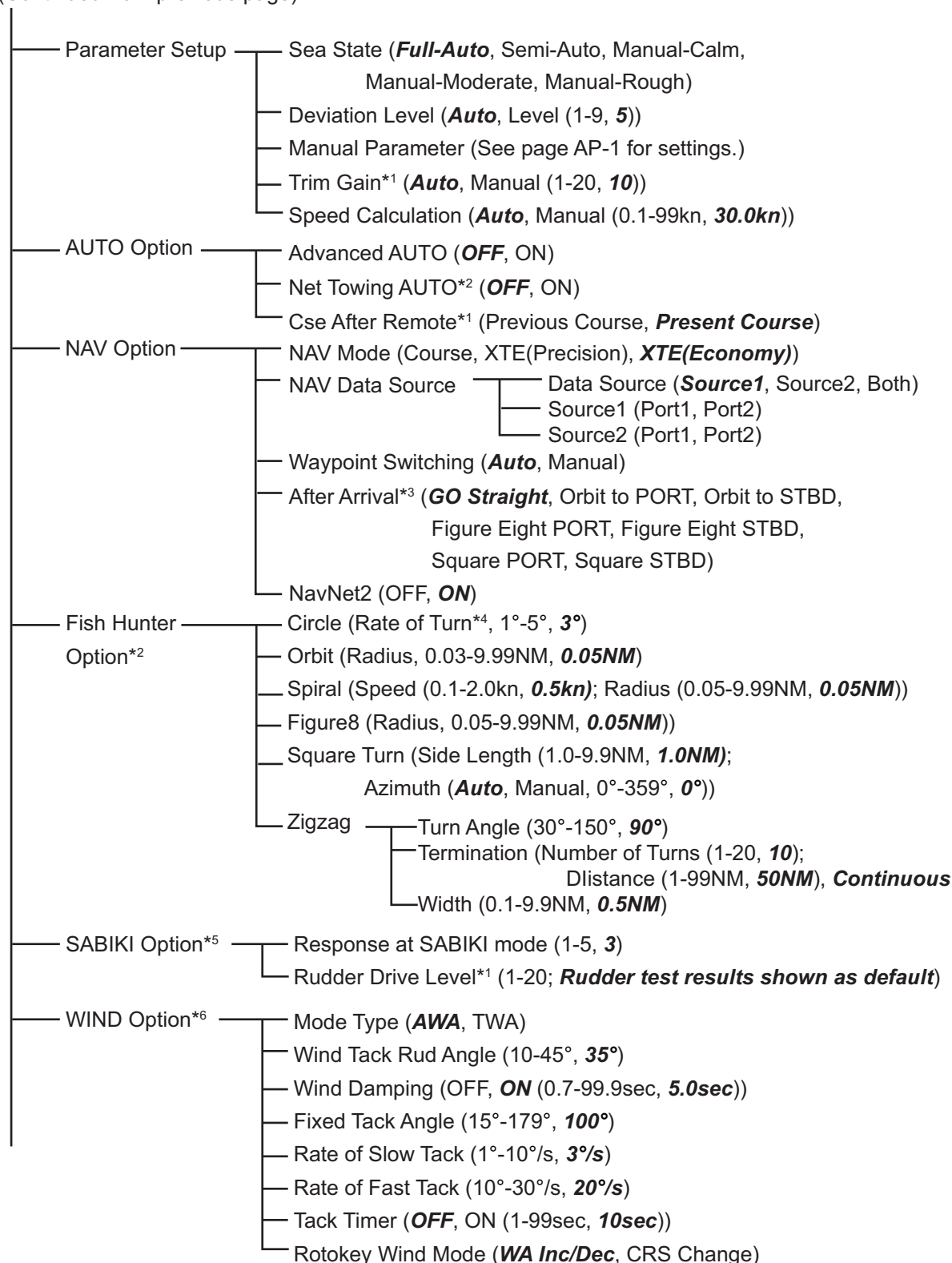

(Continued on next page)

*1: Not Shown with Fantum Feedback™.

*2: Not shown when [Boat Type] = [Sailboat] or in case of Fantum Feedback™.

*3: For Fantum Feedback™, only the [GO Straight] or [Orbit to STBD] are available.

*4: Cannot be set higher than [Rate of Turn] set on the [Ship's Characteristics] menu.

*5: Shown only when SABIKI mode is activated.

*6: Shown when [Boat Type] = [Sailboat].

(Continued from previous page)

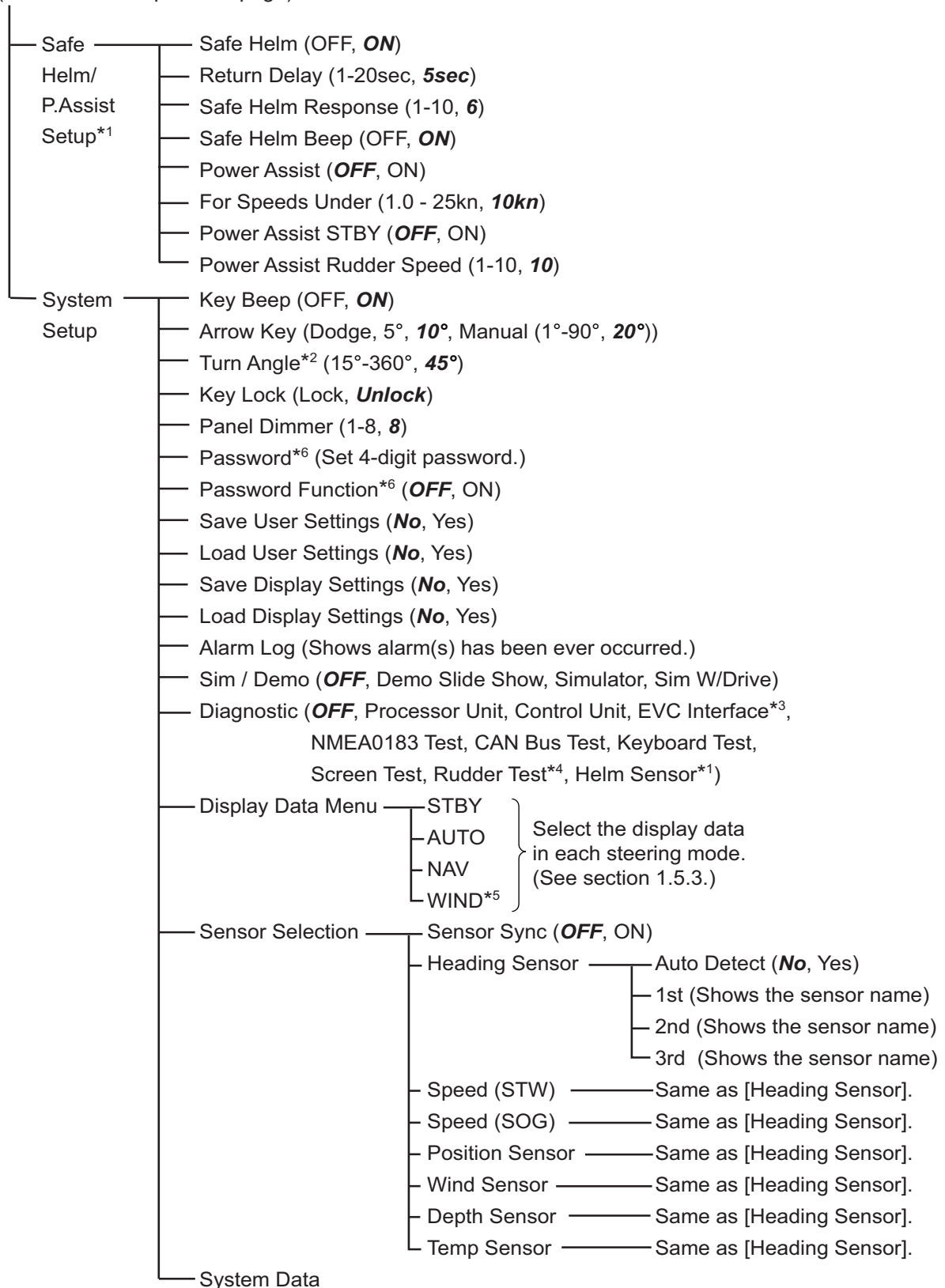

*1: Available with the Accu-Steer FPS 12V/24V type drive.

*2: Not shown when [Boat Type] = [Sailboat].

*3: Shown when [Boat Type] = [EVCS Boat].

*4: Not shown when [Boat Type] = [EVCS Boat].

*5: Shown when [Boat Type] = [Sailboat].

*6: Not available when the version of the control unit is as below.

•NAVpilot-711C: Ver.01.11 or later.

Menu in AUTO mode

Long press the  key in the AUTO mode

- Message
- Display Color (**White**, Black)
- Sensor In Use
- Brilliance (1-8, **8**)
- Rudder Drive Level*¹ (1-20, the default is depended on the rudder test.)
- Advanced AUTO (**OFF**, ON)
- Net Towing AUTO*² (**OFF**, ON)
- Cse After Remote*³ (Previous Course, **Present Course**)
- Sea State (**Full-Auto**, Semi-Auto, Manual-Calm, Manual-Moderate, Manual-Rough)
- Manual Paramer (See page AP-1.)
- Other Menu (See page AP-1 to AP-3.)

Menu in NAV mode

Long press the  key in the NAV mode

- Message
- Display Color (**White**, Black)
- Sensor In Use
- Brilliance (1-8, **8**)
- Rudder Drive Level*¹ (1-20, the default is depended on the rudder test.)
- NAV Mode (Course, XTE(Precision), **XTE(Economy)**)
- NAV Data Source
 - Data Source (**Source1**, Source2, Both)
 - Source1 (Port1, Port2)
 - Source2 (Port1, Port2)
- Waypoint Switching (**Auto**, Manual)
- After Arrival*⁴ (**GO Straight**, Orbit to PORT, Orbit to STBD,
Figure Eight PORT, Figure Eight STBD,
Square PORT, Square STBD)
- NavNet2 (OFF, **ON**)
- Sea State (**Full-Auto**, Semi-Auto, Manual-Calm, Manual-Moderate, Manual-Rough)
- Manual Paramer (See page AP-1.)
- Other Menu (See page AP-1 to AP-3.)

*1: Shown with Fantum Feedback™.

*2: Not shown when [Boat Type] = [Sailboat] or in case of Fantum Feedback™.

*3: Not shown with Fantum Feedback™.

*4: For Fantum Feedback™, only the [GO Straight] or [Orbit to STBD] are available.

Menu in WIND mode

Long press the  key in the WIND mode

- Message
- Display Color (**White**, Black)
- Sensor In Use
- Brilliance (1-8, **8**)
- Mode Type (**AWA**, TWA)
- Wind Tack Rud Angle (10-45°, **35°**)
- Wind Damping (OFF, **ON** (0.7-99.9sec, **5.0sec**))
- Fixed Tack Angle (15°-179°, **100°**)
- Rate of Slow Tack (1°-10°/s, **3°/s**)
- Rate of Fast Tack (10°-30°/s, **20°/s**)
- Tack Timer (**OFF**, ON (1-99sec, **10sec**))
- Rotokey Wind Mode (**WA Inc/Dec**, CRS Change)
- Sea State (**Full-Auto**, Semi-Auto, Manual-Calm, Manual-Moderate, Manual-Rough)
- Manual Paramer (See page AP-1.)
- Other Menu (See page AP-1 to AP-3.)

APPX. 2 JIS CABLE GUIDE

Cables listed in the manual are usually shown as Japanese Industrial Standard (JIS). Use the following guide to locate an equivalent cable locally.

JIS cable names may have up to 6 alphabetical characters, followed by a dash and a numerical value (example: DPYC-2.5).

For core types D and T, the numerical designation indicates the *cross-sectional Area (mm²)* of the core wire(s) in the cable.

For core types M and TT, the numerical designation indicates the *number of core wires* in the cable.

1. Core Type

D: Double core power line

T: Triple core power line

M: Multi core

TT: Twisted pair communications
(1Q=quad cable)

2. Insulation Type

P: Ethylene Propylene Rubber

3. Sheath Type

Y: PVC (Vinyl)

4. Armor Type

C: Steel

5. Sheath Type

Y: Anticorrosive vinyl sheath

6. Shielding Type

SLA: All cores in one shield, plastic tape w/aluminum tape

-SLA: Individually shielded cores, plastic tape w/aluminum tape



EX: ^{1 3 4 5 6} TTYCYSLA - 4
Designation type | # of twisted pairs

EX: ^{1 2 3 4} MPYC - 4
Designation type | # of cores

The following reference table lists gives the measurements of JIS cables commonly used with Furuno products:

Type	Core Area	Core Diameter	Cable Diameter	Type	Core Area	Core Diameter	Cable Diameter
DPYC-1.5	1.5mm ²	1.56mm	11.7mm	TTYCSLA-1	0.75mm ²	1.11mm	9.4mm
DPYC-2.5	2.5mm ²	2.01mm	12.8mm	TTYCSLA-1T	0.75mm ²	1.11mm	10.1mm
DPYC-4	4.0mm ²	2.55mm	13.9mm	TTYCSLA-1Q	0.75mm ²	1.11mm	10.8mm
DPYC-6	6.0mm ²	3.12mm	15.2mm	TTYCSLA-4	0.75mm ²	1.11mm	15.7mm
DPYC-10	10.0mm ²	4.05mm	17.1mm	TTYCY-1	0.75mm ²	1.11mm	11.0mm
DPYCY-1.5	1.5mm ²	1.56mm	13.7mm	TTYCY-1T	0.75mm ²	1.11mm	11.7mm
DPYCY-2.5	2.5mm ²	2.01mm	14.8mm	TTYCY-1Q	0.75mm ²	1.11mm	12.6mm
DPYCY-4	4.0mm ²	2.55mm	15.9mm	TTYCY-4	0.75mm ²	1.11mm	17.7mm
MPYC-2	1.0mm ²	1.29mm	10.0mm	TTYCY-4SLA	0.75mm ²	1.11mm	19.5mm
MPYC-4	1.0mm ²	1.29mm	11.2mm	TTYCYSLA-1	0.75mm ²	1.11mm	11.2mm
MPYC-7	1.0mm ²	1.29mm	13.2mm	TTYCYSLA-4	0.75mm ²	1.11mm	17.9mm
MPYC-12	1.0mm ²	1.29mm	16.8mm	TTPYCSLA-1	0.75mm ²	1.11mm	9.2mm
TPYC-1.5	1.5mm ²	1.56mm	12.5mm	TTPYCSLA-1T	0.75mm ²	1.11mm	9.8mm
TPYC-2.5	2.5mm ²	2.01mm	13.5mm	TTPYCSLA-1Q	0.75mm ²	1.11mm	10.5mm
TPYC-4	4.0mm ²	2.55mm	14.7mm	TTPYCSLA-4	0.75mm ²	1.11mm	15.3mm
TPYCY-1.5	1.5mm ²	1.56mm	14.5mm				
TPYCY-2.5	2.5mm ²	2.01mm	15.5mm				
TPYCY-4	4.0mm ²	2.55mm	16.9mm				

SPECIFICATIONS OF AUTOPILOT NAVpilot-711C

1 CONTROL UNIT

1.1 FAP-7011C

Display	4.1-inch TFT color LCD
Effective display area	82.56 x 61.92 mm, QVGA (320 x 240 dot)
Backlight	8 steps
Brilliance	700 cd/m ² typical

1.2 FAP-7001 (option)

Display	3.8-inch monochrome dot matrix LCD
Effective display area	85.2 x 43.6 mm (160 x 80 dot)
Backlight	8 steps
Contrast	16 steps

2 PROCESSOR UNIT

2.1 Steering mode	STBY, Auto, Dodge, Turn, Remote, Advanced auto*, Navigation*, Wind*, FishHunter ^{TM*}
2.2 Weather mode	AUTO, MANUAL-CALM/ MODERATE/ ROUGH
2.3 Rudder gain	AUTO/1-20 (Manual)
2.4 Counter rudder	AUTO/0-20 (Manual)
2.5 Trim gain	AUTO/1-20 (Manual)
2.6 Course change speed	1-30 deg/s
2.7 Rudder angle settings	10-45 deg
2.8 Alarm	Heading deviation, Cross-track error*, Ship's speed*, Depth*, Water temperature*, Wind*, Watch, Log trip*
2.9 Motor/ Solenoid drive	25A continuous, 50A for 5 seconds
2.10 Clutch/ Bypass drive	3A

*: external data required

3 IPS INTERFACE UNIT (OPTION)

3.1 Control system	EVC system
3.2 Steering mode	Auto, Manual, Dodge, Turn, Remote, Advanced auto*, Navigation*, Wind*, FishHunter ^{TM*} , Override (*: external data required)
3.3 Rudder function	Weather status, Rudder angle, Rudder gain, Trim gain, Course change speed (setting range: same as processor unit)

4 INTERFACE

4.1 Number of port	
NMEA0183	2 ports (includes the port for IPS interface unit)
CAN bus	1 port
Relay contact output	2 ports, alarm and status, 30V max., 3A max.

	Contact signal input	2 ports, event switch control
	USB	1 port, for maintenance only
4.2	Data sentences	NMEA 0183 Ver1.5/2.0/3.0
	Input	AAM, APB, BOD, BWC, BWR, DBT, DPT, GGA, GLL, GNS, HDG, HDM, HDT, MTW, MWV, ROT, RMB, RMC, THS, TLL, VHW, VTG, VWR, VWT, XTE, ZDA
	Output	DBT, DPT, GGA, GLL, GNS, HDG, HDM, HDT, MTW, MWV, RMB, RMC, ROT, RSA, VHW, VTG, VWR, VWT, ZDA
4.3	CAN bus PGN (NMEA2000)	
	Input	059392/904,060928,061184,126208/720/992/996, 127250/251/258/488/489,128259/267, 129025/026/029/033/283/284/285, 130306/310/311/312/313/314/577/880/818/821/827
	Output	059392/904,060928,061184,126208/464/720/992/996, 127237/245/250/251/258,128259/267, 129025/026/029/033/283/284/285, 130306/310/311/312/822/823/827

5 POWER SUPPLY

5.1	Processor unit (w/ control units)	12-24 VDC: 4.0-2.0 A (control unit: 6 sets)
5.2	IPS interface unit	12-24 VDC: 0.4-0.2 A

6 ENVIRONMENTAL CONDITION

6.1	Ambient temperature	-15°C to +55°C
6.2	Relative humidity	95% or less at 40°C
6.3	Degree of protection	
	Control unit	IP56
	Processor unit	IP20
	Rudder reference unit/ IPS I/F	IPX5
6.4	Vibration	IEC 60945 Ed.4

7 UNIT COLOR

7.1	Control/processor unit	N2.5
7.2	Remote controller	N3.0 (FAP-5552/6232), N1.5 (FAP-6212/6222)
7.3	Rudder reference unit	N1.5
7.4	Junction box/ IPS I/F	N3.0

PACKING LIST

FAP-7011C

64BB-X-9875 -3 1/1
A-1

NAME	OUTLINE	DESCRIPTION/CODE No.	Q'TY
ユニット UNIT			
操作部1D CONTROL UNIT 1D		FAP-7011C/-A/-B 000-042-830-00 **	1
付属品 ACCESSORIES			
ターミナルコネクタ TERMINATOR		BD-07AFFM-LR7001 001-081-140-10	1
工事材料 INSTALLATION MATERIALS			
スマウントスポンジ SPONGE		TZ8103008A0 000-200-230-10	1
ケーブル組品 CABLE ASSEMBLY		BD-07AFFM-LR-150 001-081-180-10	1
注意ラベル LABEL		64-032-1121-0 100-444-270-10	1 (*1)
注意ラベル(C) LABEL		64-032-1123-0 100-444-290-10	1 (*1)
注意ラベル(E) LABEL		64-032-1122-0 100-444-280-10	1 (*1)
図書 DOCUMENT			
ラベル貼付要領 LABEL ATTACHING GUIDE		C72-02301-* 000-200-658-1*	1
取扱説明書 OPERATOR'S MANUAL		OM*-72780-* 000-200-723-1* **	1

コード番号末尾の[**]は、選択品の代表コードを表します。

CODE NUMBER ENDING WITH "**" INDICATES THE CODE NUMBER OF REPRESENTATIVE MATERIAL.

(*1)は、それぞれ仕様選択品を表します。

(*1)INDICATE SPECIFICATION SELECTIVE ITEM.

(略図の寸法は、参考値です。 DIMENSIONS IN DRAWING FOR REFERENCE ONLY.)



表1 TABLE 1

寸法区分 (mm) DIMENSION	公差 (mm) TOLERANCE
L ≤ 50	±1.5
50 < L ≤ 100	±2.5
100 < L ≤ 500	±3

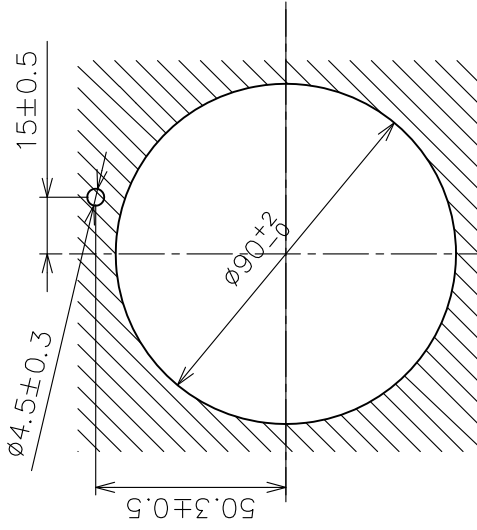
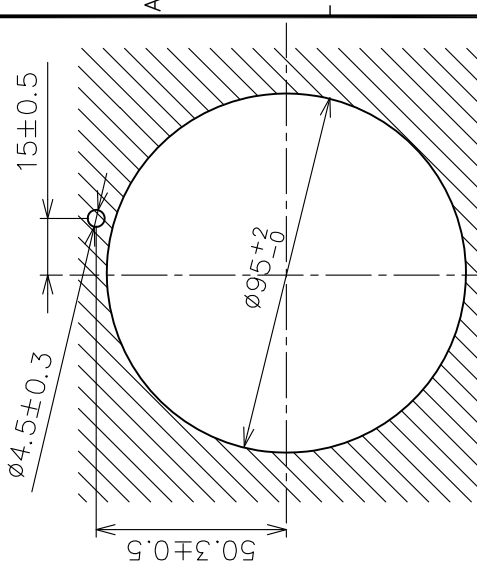

取付穴寸法図 (壁厚10mまで)
CUTOUT DIMENSIONS (BULKHEAD: 10 OR LESS)

取付穴寸法図 (壁厚10~20m用)
CUTOUT DIMENSIONS (BULKHEAD: 10 TO 20)

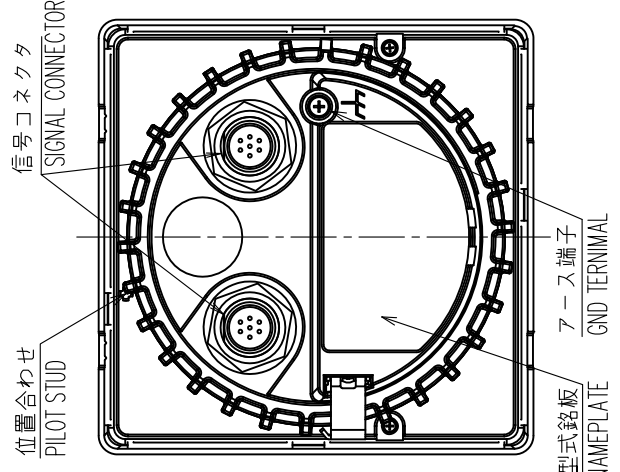
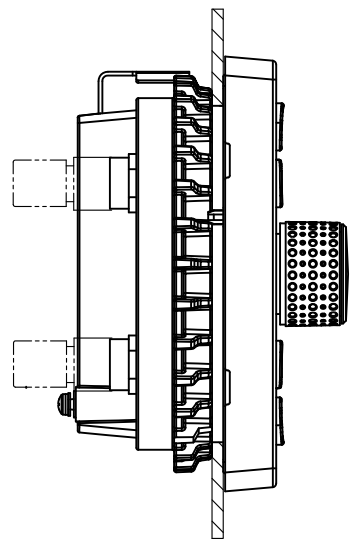

位置合わせ
PILOT STUD

信号コネクタ
SIGNAL CONNECTOR

型式銘板
NAMEPLATE

7-ース端子
GND TERMINAL

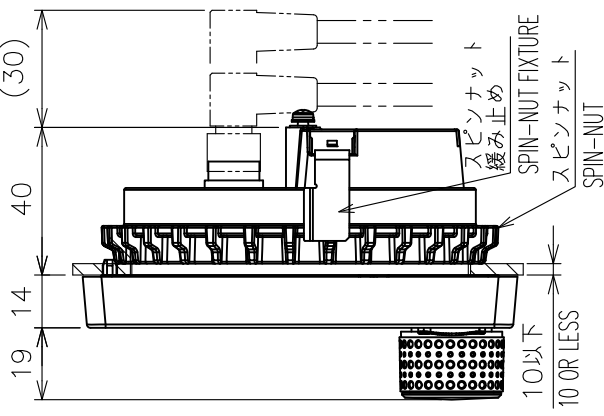

スピナット
緩み止め
SPIN-NUT FIXTURE

スピナット
SPIN-NUT

19 14 40 (30)

10以下
10 OR LESS

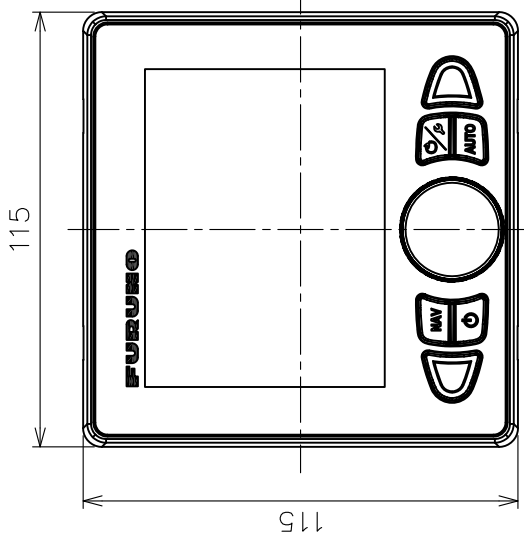

115

115

図1
Fig. 1

- 注記 1) 指定外の寸法公差は表1による。
2) 壁厚10~20の場合の取付方法は図1による。
(スピナット向きを逆にして取付ける)
- NOTE 1. TABLE 1 INDICATES TOLERANCE OF DIMENSIONS WHICH IS NOT SPECIFIED.
2. FIG. 1 INDICATES THE METHOD OF FIXING TO A BULKHEAD THICKNESS 10 TO 20.
(REVERSE THE SPIN-NUT TO SCREW THE UNIT)

DRAWN	4/Oct/2013	I. YAMASAKI	TITLE	FAP-7011C
CHECKED	4/Oct/2013	H. MAKI	名称	操作部
APPROVED	4/Oct/2013	H. MAKI	外寸図	外寸図
SCALE	1/100	質量はケーブルを含みません。 MASS DOES NOT INCLUDE CABLE.	NAME	CONTROL UNIT
DMC No.	C7278-G01-B	REF. No.	64-032-100G-3	OUTLINE DRAWING



表1 TABLE 1

ITEM No.	VOLVO INTERFACE KIT FAP-6300	YAMAHA INTERFACE KIT FAP-6310
1	IPS INTERFACE UNIT IF-700IPS	
2	MJ-A7SPF0005-020C	
3	VOLVO IPS GATEWAY	YAMAHA HM GATEWAY

A

B

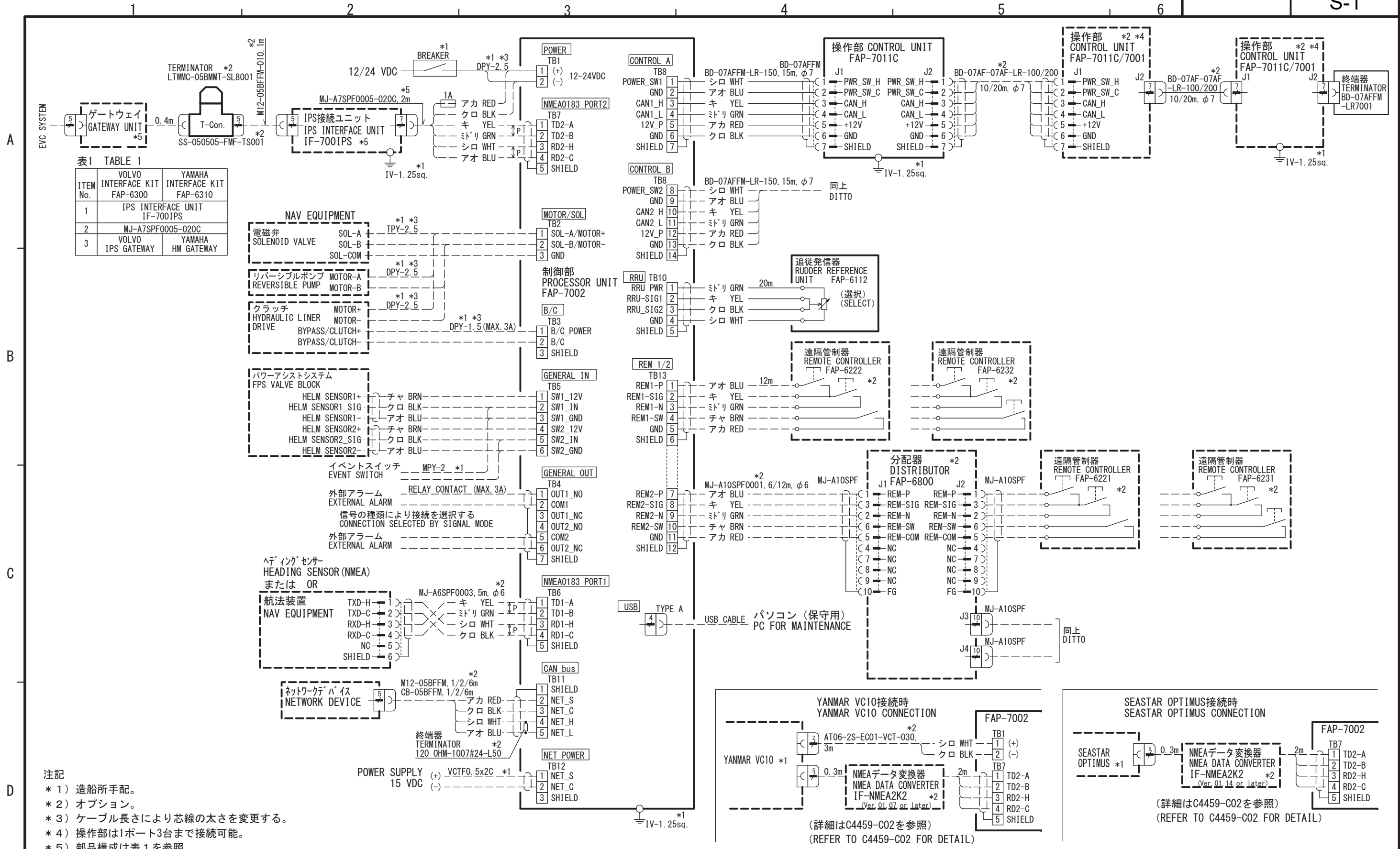
C

D

- 注記
- * 1) 造船所手配。
 - * 2) オプション。
 - * 3) ケーブル長さにより芯線の太さを変更する。
 - * 4) 操作部は1ポート3台まで接続可能。
 - * 5) 部品構成は表 1 を参照。

- NOTE
- *1: SHIPYARD SUPPLY.
 - *2: OPTION.
 - *3: CHANGE THE CORE SIZE ACCORDING TO CABLE LENGTH.
 - *4: THREE SETS OF CONTROL UNIT ARE AVAILABLE TO ONE PORT.
 - *5: REFER TO TABLE 1 FOR COMPONENT COMPOSITION.

DRAWN	1/Nov/2024 S. HAN	TITLE	NAVpilot-711C
CHECKED	1/Nov/2024 T. YAMASAKI	名称	自動操舵装置
APPROVED	5/Nov/2024 A. Murao		相互結線図
SCALE	MASS kg	NAME	AUTOPILOT
DWG No.	C7278-C01- J	REF. No.	INTERCONNECTION DIAGRAM

INDEX

Numerics

180-degree turn..... 2-9

A

Adjust the brilliance 1-3

Advanced AUTO mode 2-3, 7-33

Air bleeding 7-6, 7-10

Alarm buzzer 3-1

Alarm log 4-10

Alarm menu 3-1

Alarms

alarm menu 3-1

arrival alarm 3-3

buzzer 3-1

buzzer interval 3-2

depth alarm 3-4

deviation 3-2

heading change alarm 3-6

speed alarm 3-4

trip distance alarm 3-5

true wind speed alarm 3-7

watch alarm 3-2

water temperature alarm 3-5

wind deviation alarm 3-7

XTE alarm 3-3

Apparent wind speed alarm 3-7

Arrival alarm 3-3

Arrow key function 4-9

AUTO mode 2-2

Auto rudder limit 7-8

B

Buzzer interval 3-2

C

CAN bus port setup 7-19

CAN bus test 5-5

Circle turn 2-13

Compass display 1-4

Control Unit 1-1

Control unit test 5-3

Counter rudder setting 4-3, 7-32

Course after remote operation 4-6, 7-34

D

Data Source Setup 4-8, 7-23

Depth alarm 3-4

Deviation alarm 3-2

Diagnostic

CAN bus test 5-5

EVC interface test 5-4

Key test 5-5

Diagnostics

control unit test 5-3

diagnostics menu 5-2

helm sensor test 5-10

NMEA 0183 test 5-5

processor unit test 5-3

rudder test 5-6

screen test 5-6

Dial-type remote controller (FAP-5551, FAP-5552) 2-22

Display data in AUTO mode 4-10

Display settings saving, loading 4-9

Display setup 7-2

Dockside setup 7-4, 7-10

DODGE mode

AUTO mode 2-22

STBY mode 2-22

Drive unit setup 7-10

E

Engine speed display 1-6

EVC interface test 5-4

F

Fantum Feedback 7-4

Figure-eight turn 2-12, 2-15

FishHunter mode

circle turn 2-11, 2-13

figure-eight turn 2-15

orbit turn 2-14

spiral turn 2-12, 2-14

square turn 2-12, 2-15

zigzag turn 2-16

Fuse replacement 5-2

G

GENERAL IN 7-24

GENERAL OUT 7-24

Graphic display 1-4

H

Heading change alarm 3-6

Helm sensor test 5-10, 7-13

Highway display 1-5

I

Installation menu window 7-2

K

Key beep 4-9

Key lock 4-9

Key test 5-5

L

Language selection 7-1

M

Maintenance 5-1

Manual rudder limit 7-8

Menu shortcuts

creating 4-10

deleting 4-11

INDEX

- Menu tree AP-1
- Messages 5-11
- N**
- NAV mode
 - boat's behavior after switching waypoint.. 2-6
 - data source 4-6
 - description 2-4
 - sailing method for 2-5
 - waypoint switching method 2-6
- NavNet vx2 synchronization 4-7
- Net towing 4-5, 7-34
- NFU dodge in STBY mode 2-22
- NMEA 0183 test 5-5
- NMEA0183 port setup 7-21
- Numerical display 1-7
- O**
- Orbit turn 2-11, 2-14
- P**
- Panel dimmer 4-9
- Parameter setup menu 4-1
- Password 4-9
- Power assist mode 2-34
- Power assist setup 7-15
- Power off the system 1-2
- Power the system 1-2
- Processor unit test 5-3
- R**
- REMOTE mode 2-22
- Response feature
 - auto 2-7
 - manual 2-7
- RRU sensor alignment 7-5
- RRU type setting 7-5
- Rudder display 1-6
- RUDDER DRIVE LEVEL 4-5
- Rudder gain setting 4-3, 7-31
- Rudder limit setup 7-7
- Rudder test 5-6, 7-8, 7-10
- S**
- SABIKI mode 2-18
 - adjusting response 2-20
 - operation 2-19
 - rudder drive settings 2-20
- Safe helm mode 2-33
- Safe helm setup 7-14
- Screen test 5-6
- Sea state
 - automatic setup 4-1, 7-30
 - manual setup 4-2, 7-30
- Sea trial 7-26
- Select a display 1-4
- Selection of data 1-8, 1-10
- Set the display color 1-3
- Ship's characteristics setup 7-3
- Simulation mode 4-10
- Speed alarm 3-4
- Speed calculation 4-5, 7-33
- Spiral turn 2-14
- Square turn 2-15
- Startup test 1-2
- STBY mode
 - description 2-1
- Steering mode data 1-6
- System configuration xi
- System data 5-11
- T**
- TACK mode
 - AUTO mode 2-27
 - damping interval for wind data 2-30
 - fast, slow tracking rate of turn 2-28
 - fixed tack angle 2-28
 - max rudder angle 2-30
 - tack timer 2-31
 - WIND mode 2-29
- Trim gain setting 4-4, 7-32
- Trip distance alarm 3-5
- Trip distance reset 3-6
- True wind speed alarm 3-7
- Turn angle in TURN mode 4-9
- TURN mode
 - 180-degree turn 2-9
 - 360-degree turn 2-9
 - turn selection 2-8
 - user turn 2-9
- U**
- Unit selection 7-1
- Universal port setup 7-24
- User settings saving, loading 4-9
- User turn 2-9
- W**
- Watch alarm 3-2
- Water temperature alarm 3-5
- Weather setting 4-3, 7-31
- Wind deviation alarm 3-7
- Wind display 1-5
- WIND mode
 - starting 2-25
 - wind angle 2-26
- X**
- XTE alarm 3-3
- Z**
- Zigzag turn 2-13, 2-16

FURUNO Worldwide Warranty for Pleasure Boats (Except North America)

This warranty is valid for products manufactured by Furuno Electric Co. (hereafter FURUNO) and installed on a pleasure boat. Any web based purchases that are imported into other countries by anyone other than a FURUNO certified dealer may not comply with local standards. FURUNO strongly recommends against importing these products from international websites as the imported product may not work correctly and may interfere with other electronic devices. The imported product may also be in breach of the local laws and mandated technical requirements. Products imported into other countries as described previously shall not be eligible for local warranty service.

For products purchased outside of your country please contact the national distributor of Furuno products in the country where purchased.

This warranty is in addition to the customer's statutory legal rights.

1. Terms and Conditions of Warranty

FURUNO guarantees that each new FURUNO product is the result of quality materials and workmanship. The warranty is valid for a period of 2 years (24 months) from the date of the invoice, or the date of commissioning of the product by the installing certified dealer.

2. FURUNO Standard Warranty

The FURUNO standard warranty covers spare parts and labour costs associated with a warranty claim, provided that the product is returned to a FURUNO national distributor by prepaid carrier.

The FURUNO standard warranty includes:

- Repair at a FURUNO national distributor
- All spare parts for the repair
- Cost for economical shipment to customer

3. FURUNO Onboard Warranty

If the product was installed/commissioned and registered by a certified FURUNO dealer, the customer has the right to the onboard warranty.

The FURUNO onboard warranty includes

- Free shipping of the necessary parts
- Labour: Normal working hours only
- Travel time: Up to a maximum of two (2) hours
- Travel distance: Up to a maximum of one hundred and sixty (160) KM by car for the complete journey

4. Warranty Registration

For the Standard Warranty - presentation of product with serial number (8 digits serial number, 1234-5678) is sufficient. Otherwise, the invoice with serial number, name and stamp of the dealer and date of purchase is shown.

For the Onboard Warranty your FURUNO certified dealer will take care of all registrations.

5. Warranty Claims

For the Standard Warranty - simply send the defective product together with the invoice to a FURUNO national distributor. For the Onboard Warranty – contact a FURUNO national distributor or a certified dealer. Give the product's serial number and describe the problem as accurately as possible.

Warranty repairs carried out by companies/persons other than a FURUNO national distributor or a certified dealer is not covered by this warranty.

6. Warranty Limitations

When a claim is made, FURUNO has a right to choose whether to repair the product or replace it.

The FURUNO warranty is only valid if the product was correctly installed and used. Therefore, it is necessary for the customer to comply with the instructions in the handbook. Problems which result from not complying with the instruction manual are not covered by the warranty.

FURUNO is not liable for any damage caused to the vessel by using a FURUNO product.

The following are excluded from this warranty:

- a. Second-hand product
- b. Underwater unit such as transducer and hull unit
- c. Routine maintenance, alignment and calibration services.
- d. Replacement of consumable parts such as fuses, lamps, recording papers, drive belts, cables, protective covers and batteries.
- e. Magnetron and MIC with more than 1000 transmitting hours or older than 12 months, whichever comes first.
- f. Costs associated with the replacement of a transducer (e.g. Crane, docking or diver etc.).
- g. Sea trial, test and evaluation or other demonstrations.
- h. Products repaired or altered by anyone other than the FURUNO national distributor or an authorized dealer.
- i. Products on which the serial number is altered, defaced or removed.
- j. Problems resulting from an accident, negligence, misuse, improper installation, vandalism or water penetration.
- k. Damage resulting from a force majeure or other natural catastrophe or calamity.
- l. Damage from shipping or transit.
- m. Software updates, except when deemed necessary and warrantable by FURUNO.
- n. Overtime, extra labour outside of normal hours such as weekend/holiday, and travel costs above the 160 KM allowance
- o. Operator familiarization and orientation.

FURUNO Electric Company, March 1, 2011

FURUNO Warranty for North America

FURUNO U.S.A., Limited Warranty provides a twenty-four (24) months LABOR and twenty-four (24) months PARTS warranty on products from the date of installation or purchase by the original owner. Products or components that are represented as being waterproof are guaranteed to be waterproof only for, and within the limits, of the warranty period stated above. The warranty start date may not exceed eighteen (18) months from the original date of purchase by dealer from Furuno USA and applies to new equipment installed and operated in accordance with Furuno USA's published instructions.

Magnetrons and Microwave devices will be warranted for a period of 12 months from date of original equipment installation.

Furuno U.S.A., Inc. warrants each new product to be of sound material and workmanship and through its authorized dealer will exchange any parts proven to be defective in material or workmanship under normal use at no charge for a period of 24 months from the date of installation or purchase.

Furuno U.S.A., Inc., through an authorized Furuno dealer will provide labor at no cost to replace defective parts, exclusive of routine maintenance or normal adjustments, for a period of 24 months from installation date provided the work is done by Furuno U.S.A., Inc. or an AUTHORIZED Furuno dealer during normal shop hours and within a radius of 50 miles of the shop location.

A suitable proof of purchase showing date of purchase, or installation certification must be available to Furuno U.S.A., Inc., or its authorized dealer at the time of request for warranty service.

This warranty is valid for installation of products manufactured by Furuno Electric Co. (hereafter FURUNO). Any purchases from brick and mortar or web-based resellers that are imported into other countries by anyone other than a FURUNO certified dealer, agent or subsidiary may not comply with local standards. FURUNO strongly recommends against importing these products from international websites or other resellers, as the imported product may not work correctly and may interfere with other electronic devices. The imported product may also be in breach of the local laws and mandated technical requirements. Products imported into other countries, as described previously, shall not be eligible for local warranty service.

For products purchased outside of your country please contact the national distributor of Furuno products in the country where purchased.

WARRANTY REGISTRATION AND INFORMATION

To register your product for warranty, as well as see the complete warranty guidelines and limitations, please visit www.furunousa.com and click on "Support". In order to expedite repairs, warranty service on Furuno equipment is provided through its authorized dealer network. If this is not possible or practical, please contact Furuno U.S.A., Inc. to arrange warranty service.

FURUNO U.S.A., INC.
Attention: Service Coordinator
4400 N.W. Pacific Rim Boulevard
Camas, WA 98607-9408
Telephone: (360) 834-9300
FAX: (360) 834-9400

Furuno U.S.A., Inc. is proud to supply you with the highest quality in Marine Electronics. We know you had several choices when making your selection of equipment, and from everyone at Furuno we thank you. Furuno takes great pride in customer service.



Declaration of Conformity



We **FURUNO ELECTRIC CO., LTD.**

(Manufacturer)

9-52 Ashihara-Cho, Nishinomiya City, 662-8580, Hyogo, Japan

(Address)

declare under our sole responsibility that the product

AUTOPILOT NAVpilot-711C

(Model name, type number)

to which this declaration relates conforms to the following standard(s) or other normative document(s)

EU
EMC Directive 2014/30/EU

UK
SI 2016 No.1091 EMC Regulations 2016 as amended

IEC 60945 Ed.4.0: 2002

EN 60945: 2002

For assessment, see

- Test report
Furuno Labotech International Co., Ltd.
FLI 12-13-084, 17 Oct 2013

For assessment, see

- Test report
Furuno Labotech International Co., Ltd.
FLI 12-13-084, 17 Oct 2013

(title and/or number and date of issue of the standard(s) or other normative document(s))

On behalf of Furuno Electric Co., Ltd.

Nishinomiya City, Japan
26 July 2021

(Place and date of issue)

Akihiko Kanechika
Department General Manager
Quality Assurance Department

(name and signature or equivalent marking of authorized person)

PSTI Statement of Compliance

We **FURUNO ELECTRIC CO., LTD.**

(Name of manufacturer of the product)

9-52 Ashihara-Cho, Nishinomiya City, 662-8580, Hyogo, Japan

(Address of manufacturer of the product)

declare under our sole responsibility that the product

**AUTOPILOT,
NAVpilot-711C**

(Product type, batch)

December / 31 / 2026

(Support period for the product)

https://www.furuno.co.jp/en/csr/sociality/customer/product_security.html

(Weblink for latest information and contact to report to the manufacturer security issues)

to which this declaration relates conforms to the following standard(s) or other normative document(s)

Product Security and Telecommunications Infrastructure Act 2022

Product Security and Telecommunications Infrastructure (Security Requirements for
Relevant Connectable Products) Regulations 2023 Schedule 1

On behalf of Furuno Electric Co., Ltd.

Nishinomiya City, Japan
11 June 2024

(Place and date of issue)

Akihiko Kanechika
Department General Manager
Quality Assurance Department

(Signature, name and function of the signatory)



FAP-7011C
Surface Mount Template
サーフェイスマウント型紙

