

# FURUNO

MODEL

# SCX-20/21

## SATELLITE COMPASS™



SCX-20  
NMEA2000

SCX-21  
NMEA0183



SCX-20 ONLY



[www.furuno.com](http://www.furuno.com)

# AMAZING MULTI-GNSS SATELLITE COMPASS™

RELIABLE ACCURACY IN THE MOST CHALLENGING SITUATIONS

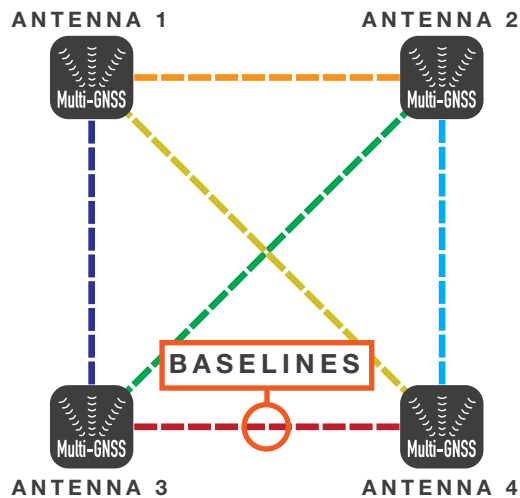

The SCX-20 and SCX-21 are designed with simplicity in mind and can be mounted virtually anywhere on the vessel.

**Utilizing four separate GNSS Antennas** for the ultimate in responsiveness, the SCX-20 and SCX-21 set a new standard for reliable and accurate heading for all of your marine electronics. Traditionally, a Satellite Compass™ calculates heading using one baseline between two antennas; the SCX-20/21's four antennas can calculate heading information using any one of the six baselines drawn between the four antennas.

The unprecedented quad-antenna design of the SCX-20 and SCX-21 makes them capable of calculating extremely accurate heading, pitch, roll, and heave information. They are the perfect heading solution for complex vessel installations where the view of satellites may sometimes be obstructed.



The SCX-20 is a perfect companion unit for the NAVpilot-300.



# RADAR ECHO TRAIL ZIG-ZAG DOMINATION

TESTED. PROVEN. SUPERIOR.

## FURUNO SCX-20/21

When connected to Furuno SCX-20/21, the Radar's echo trails hold steady and clearly depict an accurate echo trail thanks to the SCX-20/21's amazing accuracy.

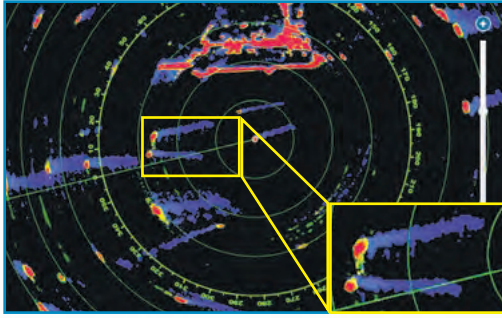

## Company A

Company A's satellite compass fails to uphold a steady heading, making echo trails virtually unintelligible.

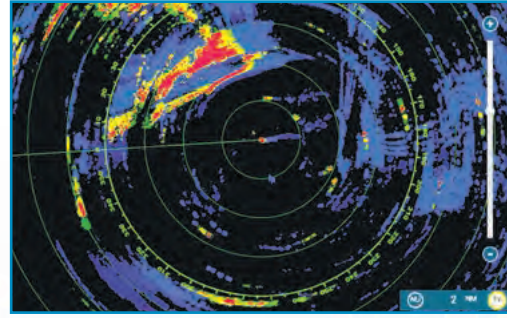

## Company B

Company B's heading accuracy fluctuates by +/- 3° with a slower update, causing an echo trail that has a wide zig-zag pattern.

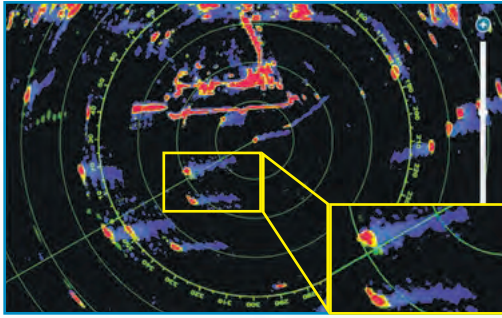

## Company C

Company C's heading accuracy fluctuates by +/- 5° with a faster update, causing an echo trail that is indistinguishable and confusing.

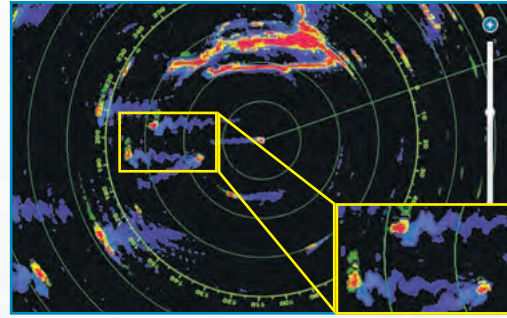

**MORE ACCURATE**

SCX-20/21 < COMPANY B < COMPANY C < COMPANY A

**LESS ACCURATE**

## RELAY CRITICAL DATA

Effortlessly connect with existing Furuno systems in order to elevate your awareness of own vessel and the surrounding area by displaying critical information across several products including NavNet TZtouch MFD's, NAVpilot-300, FI-70, and GP-39! Initial setup can be done from NavNet series MFD, NAVpilot-300 and GP-39.



- 3-Axis Speed
- Pitch, Roll, Heave
- Rate of Turn (RoT)
- Heading (HDG)

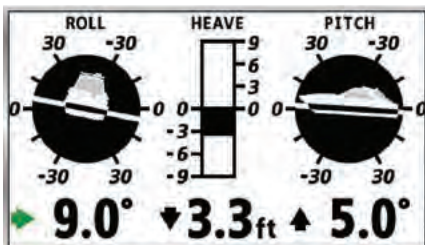

GP-39

FI-70

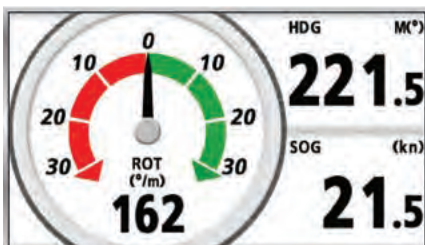





Connect the SCX-20 to NavNet TZtouch MFD's for highly accurate heading data!

## EXPERIENCE SUPERIOR ACCURACY

The SCX-20 and SCX-21 enhance the performance of onboard equipment such as Radar, Fish Finders, Sonar, and Autopilots. Accurate heading information empowers your NAVpilot to keep a better course, saving time, fuel, and money on every voyage; meanwhile, precise pitch, roll, and heave information stabilizes the display for many Furuno Fish Finders and Sonars, allowing for an accurate presentation even in the roughest of seas.

### RADAR/PLOTTER

True echo trails are available when the SCX-20 or SCX-21 is connected to your Furuno Radar, helping to determine own ship's movement as well as the movement of other vessels. Accurate speed and heading data ensures that target trails are displayed smoothly and accurately, without the jagged, zig-zag appearance common to compasses with a higher degree of deviation.

### TRUE MOTION TARGET TRAILS

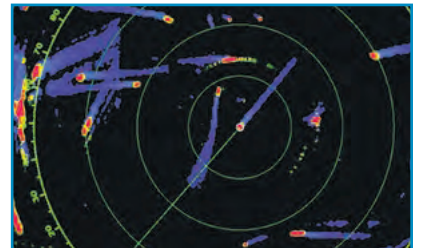

### FISH FINDER

Even in heavy seas, accurate heave compensation from SCX-20 or SCX-21 enable Fish Finders such as the FCV-1150 or NavNet TZtouch/TZtouch2/TZtouch3 to show you an unwavering presentation of the seabed, without the undulations caused by sea conditions.

### HEAVING COMPENSATION

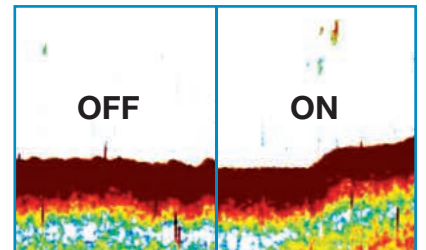

### SONAR

Accurate pitch and roll information allows Furuno Sonar systems to display a steady image on the screen, even in foul weather.

### PITCH & ROLL COMPENSATION

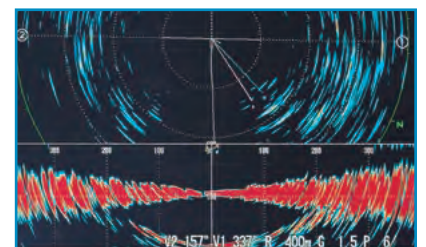

# SCX-20/21

## SATELLITE COMPASS™

- Perfect for NavNet TZtouch MFD, NAVpilot-300, and WASSP installations
- Outputs accurate Time, Position, Heading, COG/SOG, ROT, Roll/Pitch/Heave 3-Axis Speed, Air Temperature and Air Pressure data
- Unprecedented heading accuracy for Radars, Sonars, and Navigation
- Utilizes four Multi GNSS (GPS, QZSS, GLONASS, Galileo) antennas
- 1.0 degree heading accuracy, 0.02 knot speed accuracy
- Lightweight antenna - only 1.0kg!

### FURUNO SCX-20/21

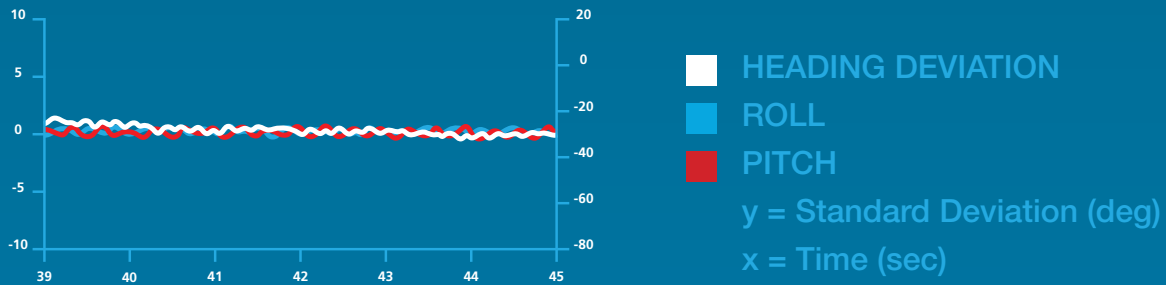

### COMPANY A

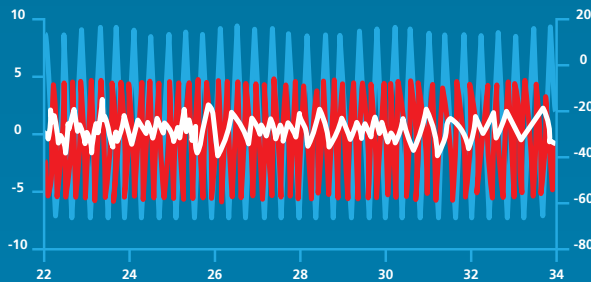

### COMPANY B

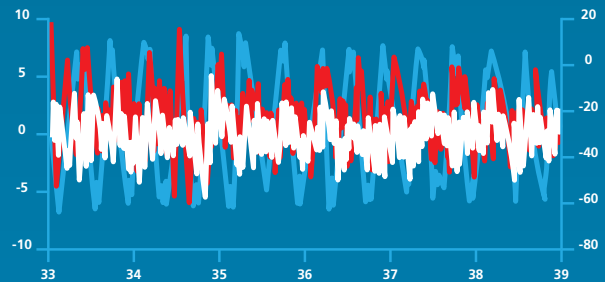

#### Test Conditions:

Roll - Amplitude 20°, 10 sec. period

Pitch - Amplitude 10°, 6 sec. period

Heading - 5°, 15 sec. period

Standard - ISO22090-3 (2015)



SCX-20  
NMEA2000



SCX-21  
NMEA0183

**GENERAL**

Frequency	1575.42 MHz (GPS/Galileo/QZSS/SBAS) 1602.5625 MHz (GLONASS)
Tracking Code	C/A (GPS/QZSS/SBAS), E1B (Galileo), L10F (GLONASS)
Attitude	Heading/Roll/Pitch: 1.0° rms (static) 0.5° rms (dynamic)
Follow Up	45°/sec
Heave Accuracy	σ5cm
Timing	(1PPS Accuracy: 50µs (SCX-21 only)
Settling Time	60 seconds approx.
Position Accuracy	
GPS:	5m approx. (2 drms, HDOP < 4)
MSAS:	4m approx. (2 drms, HDOP < 4)
WAAS:	3m approx. (2 drms, HDOP < 4)
Position Fix Time	50 seconds approx.
Update Interval	
Attitude:	50 Hz MAX
Position:	10 Hz MAX
Ship Speed Accuracy	
SOG:	0.02 kn rms (tracking satellites 5 or more) 0.2 kn rms (tracking satellites 3 or more)
VBW:	0.02 kn rms (tracking satellites 5 or more, at antenna position) 0.08 kn rms (tracking satellites 5 or more, at another position) 2.0% of ship's speed or 0.2 kn, whichever is greater (tracking satellites 3 or 4)
Pressure	850 to 1100 hPa (temp range: 0°C to > 50°C), ± 1.0 hPa (offset adjustment)
Temperature	-20°C to > 55°C (relative wind: ≥ 4 kn), ± 2.0°C (offset adjustment)

**POWER SUPPLY**

Standard: 12-24 VDC: 0.2-0.1 A (4 LEN @ 9 VDC)

**INTERFACE**

Ports	
SCX-20:	1 Port NMEA2000
Input	059392/904, 060160/416/928, 061184, 065240, 126208/720, 130847
Output	059392/904, 060928, 061184, 065280, 126208/464/720/992/993/996/998, 127250/251/252/257/258, 129025/026/029/538/539/540, 130310/312/314/316/577/578/816/817/818/819/822/823, 130833/834/842/843/845/846/847
SCX-21:	3 Ports NMEA0183, Tx 3 Ch, Rx 2 Ch 1 Port PPS, RS-485, rising edge detecting

Data Sentences	
Input:	AAM*, APB*, BOD*, BWC*, BWR*, RMB*, TLL*, XDR, XTE*
Output:	AAM*, APB*, BOD*, BWR*, DTM, GGA, GLL, GNS, GSA, GSV, HDG, HDT, HRM, POS, RMB*, RMC, ROT, THS, TLL*, VBW, VTG, XTE*, ZDA GPatt, GPphve, GPimu, pidat, SDmrk*, GPmstv, hdcom
P Sentences	*: GP-39 REQUIRED

**ENVIRONMENTAL CONDITIONS**

Ambient Temperature:	-25°C to +55°C (storage: -30°C to 70°C)
Relative Humidity:	95% or less at +40°C
Degree of Protection:	IP56

**EQUIPMENT**

Cable Assembly	SCX-20: FRU-NMEA-PMMFF cable (6m) SCX-21: FRU-CF-F cable (15m) SCX-20: Roof or Pole Mount SCX-21: Pole Mount ONLY
Standard	SCX-21: Pole Mount ONLY
Optional Supply	Installation materials, spare parts
Interface Unit:	SCX-20: FI-70 SCX-21: GP-39

**INTERCONNECTION DIAGRAM**

NMEA2000® Network Configuration:

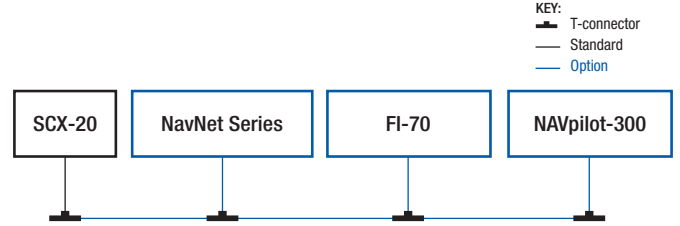

NMEA0183 Network Configuration:

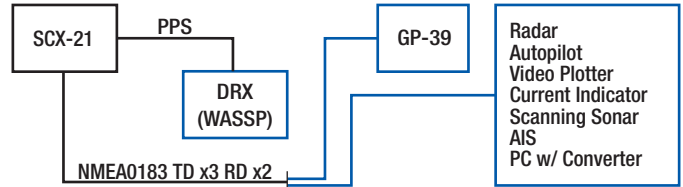

**UNIT DIAGRAMS**

SCX-20 w/ roof mount  
1.4 kg (3.0 lbs)

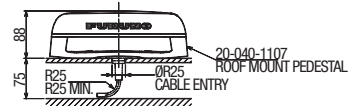
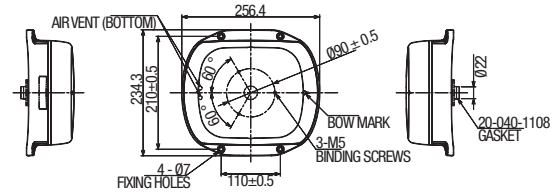

SCX-20 w/o mount  
1.0 kg (2.2 lbs)

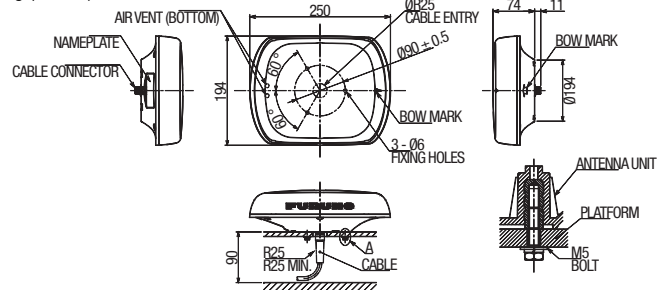

DETAIL FOR A (SCALE: 1/1)

SCX-20/21 w/ pole mount  
1.2 kg (2.64 lbs)

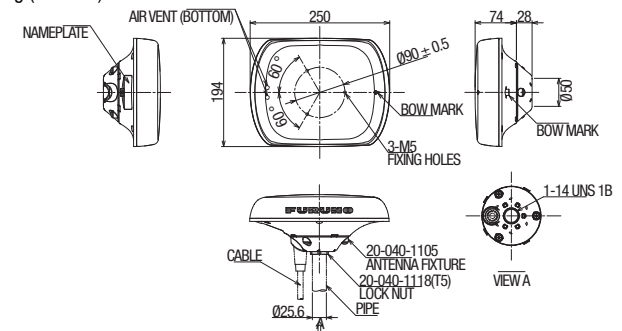

Catalog No. CA000001660  
B-2210LB

**FURUNO ELECTRIC CO., LTD.**

Japan www.furuno.com  
**FURUNO U.S.A., INC.**  
 U.S.A. www.furunousa.com  
**FURUNO PANAMA S.A.**  
 Republic of Panama www.furuno.com.pa  
**FURUNO (UK) LIMITED**  
 U.K. www.furuno.co.uk  
**FURUNO NORGE A/S**  
 Norway www.furuno.no

**FURUNO DANMARK A/S**

Denmark www.furuno.dk  
**FURUNO SVERIGE AB**  
 Sweden www.furuno.se  
**FURUNO FINLAND OY**  
 Finland www.furuno.fi  
**FURUNO POLSKA Sp. z o.o.**  
 Poland www.furuno.pl  
**FURUNO DEUTSCHLAND GmbH**  
 Germany www.furuno.de

**FURUNO FRANCE S.A.S.**

France www.furuno.fr  
**FURUNO ESPAÑA S.A.**  
 Spain www.furuno.es  
**FURUNO ITALIA S.R.L.**  
 Italy www.furuno.it  
**FURUNO HELLAS S.A.**  
 Greece www.furuno.gr  
**FURUNO (CYPRUS) LTD**  
 Cyprus www.furuno.com.cy

**FURUNO SHANGHAI CO., LTD.**

China www.furuno.com/cn  
**FURUNO CHINA CO., LTD.**  
 Hong Kong www.furuno.com/cn  
**FURUNO KOREA CO., LTD**  
 Korea  
**FURUNO SINGAPORE**  
 Singapore www.furuno.sg  
**PT FURUNO ELECTRIC INDONESIA**  
 Indonesia www.furuno.id

**FURUNO ELECTRIC (MALAYSIA) SDN. BHD.**

Malaysia www.furuno.com/my  
**BEWARE OF SIMILAR PRODUCTS**  
 All brand and product names are trademarks, registered trademarks, or service marks for their respective holders.  
**SPECIFICATIONS SUBJECT TO CHANGE WITHOUT NOTICE**