

FURUNO

OPERATOR'S MANUAL

MARINE RADAR

FAR-1513

FAR-1523

FAR-1513-BB

FAR-1523-BB

FAR-1518

FAR-1528

FAR-1518-BB

Model

FAR-1528-BB

Multi-Language Operator's Guide

Download Link

Multi-Language Operator's Guide gives you the basic information on the operation of this model. Please visit our website from the following two-dimensional code and download.



Operator's Guide is available in the following languages.

English, Simplified Chinese, Thai, Vietnamese, Bahasa Indonesia and Burmese.

FURUNO ELECTRIC CO., LTD.

9-52 Ashihara-cho,
Nishinomiya, 662-8580, JAPAN

• FURUNO Authorized Distributor/Dealer

All rights reserved. Printed in Japan

Pub. No. OME-36380-J1

(TAYA) FAR-15x3/15x8/BB

A : NOV. 2015

J1 : APR. 23, 2024



0 0 0 1 9 0 8 3 1 1 8

IMPORTANT NOTICES

General

- This manual has been authored with simplified grammar, to meet the needs of international users.
- The operator of this equipment must read and follow the instructions in this manual. Wrong operation or maintenance can void the warranty or cause injury.
- Do not copy any part of this manual without written permission from FURUNO.
- If this manual is lost or worn, contact your dealer about replacement.
- The contents of this manual and equipment specifications can change without notice.
- The example screens (or illustrations) shown in this manual can be different from the screens you see on your display. The screens you see depend on your system configuration and equipment settings.
- Save this manual for future reference.
- Any modification of the equipment (including software) by persons not authorized by FURUNO will cancel the warranty.
- The following concern acts as our importer in Europe, as defined in DECISION No 768/2008/EC.
 - Name: FURUNO EUROPE B.V.
 - Address: Siriusstraat 86, 5015 BT, Tilburg, The Netherlands
- The following concern acts as our importer in UK, as defined in SI 2016/1025 as amended SI 2019/470.
 - Name: FURUNO (UK) LTD.
 - Address: West Building Penner Road Havant Hampshire PO9 1QY, U.K.
- All brand and product names are trademarks, registered trademarks or service marks of their respective holders.
- Compliant with IMO MSC.302(87) "Bridge Alert Management".

How to discard this product

Discard this product according to local regulations for the disposal of industrial waste. For disposal in the USA, see the homepage of the Electronics Industries Alliance (<http://www.eiae.org/>) for the correct method of disposal.

How to discard a used battery

Some FURUNO products have a battery(ies). To see if your product has a battery, see the chapter on Maintenance. Follow the instructions below if a battery is used. Tape the + and - terminals of battery before disposal to prevent fire, heat generation caused by short circuit.

In the European Union

The crossed-out trash can symbol indicates that all types of batteries must not be discarded in standard trash, or at a trash site. Take the used batteries to a battery collection site according to your national legislation and the Batteries Directive 2006/66/EU.

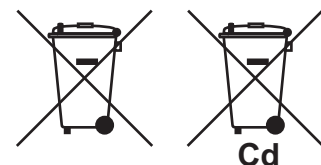

In the USA

The Mobius loop symbol (three chasing arrows) indicates that Ni-Cd and lead-acid rechargeable batteries must be recycled. Take the used batteries to a battery collection site according to local laws.





In the other countries

There are no international standards for the battery recycle symbol. The number of symbols can increase when the other countries make their own recycle symbols in the future.



SAFETY INSTRUCTIONS

The operator must read the applicable safety instructions before attempting to operate the equipment.

 DANGER	Indicates a potentially hazardous situation which, if not avoided, could result in death or serious injury.
 WARNING	Indicates a potentially hazardous situation which, if not avoided, could result in death or serious injury.
 CAUTION	Indicates a potentially hazardous situation which, if not avoided, could result in minor or moderate injury.

 Warning, Caution	 Prohibitive Action	 Mandatory Action
--	--	--

WARNING









Radio Frequency Radiation Hazard







The radar antenna emits electromagnetic radio frequency (RF) energy which can be harmful, particularly to your eyes. Never look directly into the antenna aperture from a close distance while the radar is in operation or expose yourself to the transmitting antenna at a close distance. Distances at which RF radiation level of 100, 50 and 10 W/m² are given in the table below.

Note: If the antenna unit is installed at a close distance in front of the wheel house, your administration may require halt of transmission within a certain sector of antenna revolution. This is possible. Ask your FURUNO representative or dealer to provide this feature.

Radar model	Transceiver	Magnetron	Antenna *1	100W/m ²	50W/m ²	10W/m ²
FAR-1513(-BB)	RTR-086A	MAF1565N	XN12A	N/A	-	2.1 m
			XN13A	N/A	-	1.9 m
FAR-1523(-BB)	RTR-087A	M1458F	XN12A	0.6 m	-	4.6 m
			XN13A	0.4 m	-	3.1 m
FAR-1518(-BB)	RTR-100	MAF1615B	XN12AF	0.3 m	0.7 m	4.1 m
			XN20AF	0.2 m	0.5 m	3.1 m
FAR-1528(-BB)	RTR-101	MG5436	XN20AF	0.6 m	1.2 m	6.1 m
			XN24AF	0.3 m	0.8 m	4.0 m

*1 XN12AF: 120cm, XN20AF: 198cm, XN24AF: 243cm

 WARNING	
	<p>ELECTRICAL SHOCK HAZARD. Do not open the equipment.</p> <p>Only qualified personnel should work inside the equipment.</p>
	<p>Turn off the radar power switch before servicing the antenna unit. Post a warning sign near the switch indicating it should not be turned on while the antenna unit is being serviced.</p>
	<p>Prevent the potential risk of being struck by the rotating antenna and exposure to RF radiation hazard.</p>
	<p>Do not disassemble or modify the equipment.</p> <p>Fire, electrical shock or serious injury can result.</p>
	<p>Immediately turn off the power at the ship's mains switchboard if water leaks into the equipment or the equipment is emitting smoke or fire.</p> <p>Continued use can cause fatal damage to the equipment.</p>

 WARNING	
	<p>Use the proper fuse.</p> <p>Use of a wrong fuse can result in damage to the equipment or cause fire.</p>
	<p>Keep heater away from equipment.</p> <p>Heat can alter equipment shape and melt the power cord, which can cause fire or electrical shock.</p>
	<p>Do not place liquid-filled containers near the equipment.</p> <p>Fire or electrical shock can result if a liquid spills into the equipment.</p>
	<p>Do not operate the equipment with wet hands.</p> <p>Electrical shock can result.</p>
	<p>Before servicing the radar, turn off the appropriate external breaker.</p> <p>Power is not removed from the radar simply by turning off its power switch.</p>

⚠ WARNING

No one navigational aid should be relied upon for the safety of vessel and crew. The navigator has the responsibility to check all aids available to confirm position. Electronic aids are not a substitute for basic navigational principles and common sense.

- ◆ This TT automatically tracks automatically or manually acquired radar targets and calculates their courses and speeds, indicating them by vectors. Since the data generated by the auto plotter are based on what radar targets are selected, the radar must always be optimally tuned for use with the auto plotter, to ensure required targets will not be lost or unwanted targets such as sea returns and noise will not be acquired and tracked.
- ◆ A target does not always mean a land-mass, reef, ships or other surface vessels but can imply returns from sea surface and clutter. As the level of clutter changes with environment, the operator should properly adjust the A/C SEA, A/C RAIN and GAIN controls to be sure target echoes are not eliminated from the radar screen.

WARNING LABEL

Warning labels are attached to the equipment. Do not remove any label. If a label is missing or damaged, contact a FURUNO agent or dealer about replacement.



DISPLAY UNIT & PROCESSOR UNIT

Name: Warning Label (1)
 Type: 86-003-1011-3
 Code No.: 100-236-233-10

ANTENNA UNIT

Name: Warning Label
 Type: 14-055-4202-1
 Code No.: 100-245-221-10

⚠ CAUTION

The plotting accuracy and response of this TT meets IMO standards. Tracking accuracy is affected by the following:

- ◆ Tracking accuracy is affected by course change. One to two minutes is required to restore vectors to full accuracy after an abrupt course change. (The actual amount depends on gyrocompass specifications.)
- ◆ The amount of tracking delay is inversely proportional to the relative speed of the target. Delay is on the order of 15 - 30 seconds for high relative speed; 30 - 60 seconds for low relative speed.
- ◆ The target tracking and pertinent vector calculation accuracy is influenced by the following:
 - Echo intensity
 - The range measurement accuracy; characterized by both random and biased measurement errors.
 - The angular measurement accuracy; characterized by beam shape, target glint and bias errors.
 - Radar transmission pulsewidth
 - Gyrocompass heading error
 - Speed log error
 - Current and wind (set & drift)
 - Course change (own ship and target)

The data generated by TT, AIS and video plotter are intended for reference only.

Refer to official nautical charts for detailed and up-to-date information.

TABLE OF CONTENTS

FOREWORD	xi
SYSTEM CONFIGURATION	xiii
1. OPERATIONAL OVERVIEW	1-1
1.1 Controls	1-1
1.2 How to Turn the Radar On/Off.....	1-3
1.3 How to Adjust the Brilliance.....	1-3
1.4 Display Indications.....	1-4
1.5 Menu Operations	1-6
1.5.1 How to access the main menu	1-6
1.5.2 How to operate the menus	1-6
1.6 How to Use the On-screen Box Menus	1-7
1.7 How to Use the CURSOR Menu	1-8
1.8 Cursor Data	1-9
1.9 How to Set Up Function Keys.....	1-10
1.10 How to Customize Operation.....	1-11
1.11 How to Select the Interface for Heading Input.....	1-12
1.12 How to Set Own Ship's Speed	1-12
1.12.1 Automatic speed input (log or GPS navigator).....	1-12
1.12.2 Manual speed input	1-13
1.13 How to Set the Own Ship Position.....	1-14
1.14 User Settings	1-15
1.14.1 How to reset the user settings	1-16
1.14.2 How to store/load user settings	1-16
1.15 How to Start/Stop Transmission.....	1-17
1.16 How to Tune the Receiver	1-17
1.16.1 How to select the tuning method	1-17
1.16.2 How to initialize tuning.....	1-18
1.16.3 How to tune the receiver manually	1-18
1.17 How to Select a Pulselength.....	1-18
1.17.1 How to change the pulselength	1-19
1.18 How to Adjust Sensitivity	1-19
1.19 How to Reduce Sea Clutter	1-20
1.19.1 How to select the method of clutter adjustment	1-20
1.19.2 How to fine-tune sea clutter reduction.....	1-20
1.19.3 How to manually reduce sea clutter	1-21
1.20 How to Reduce Rain Clutter	1-21
1.20.1 How to select the method of rain clutter reduction	1-22
1.20.2 How to manually reduce rain clutter	1-22
1.21 Interference Rejector	1-23
1.22 Echo Stretch.....	1-24
1.23 Echo Averaging	1-24
1.24 Automatic Clutter Elimination (ACE) Function.....	1-25
1.24.1 How to turn the Automatic Clutter Elimination (ACE) function on/off	1-25
1.24.2 How to adjust the gain in Automatic Clutter Elimination (ACE) mode	1-25
1.24.3 How to get high sensitivity.....	1-25
1.24.4 How to suppress false echoes	1-26
1.25 Noise Rejector	1-26
1.26 Wiper	1-26
1.27 How to Preset Controls for a Specific Navigation Purpose	1-27
1.27.1 How to select a customized echo.....	1-28
1.27.2 How to edit a customized echo	1-29

TABLE OF CONTENTS

1.27.3	How to restore a user customized echo to the saved settings.....	1-29
1.27.4	How to restore a user customized echo to the factory default settings.....	1-30
1.28	How to Reject Second-trace Echoes	1-30
1.29	Presentation Modes	1-31
1.29.1	How to select an presentation mode.....	1-31
1.29.2	Description of presentation modes.....	1-31
1.30	How to Select a Range Scale	1-33
1.31	How to Measure Range	1-33
1.31.1	How to show/hide the range rings.....	1-33
1.31.2	How to measure range with the variable range marker (VRM).....	1-34
1.31.3	How to set the VRM unit of measurement (non-IMO type only).....	1-35
1.31.4	How to show TTG to VRM	1-35
1.32	How to Measure Bearing.....	1-35
1.32.1	Methods to measure bearing	1-36
1.32.2	True or relative bearing	1-37
1.33	Collision Assessment by Offset EBL.....	1-37
1.33.1	How to assess risk of collision using the offset EBL	1-38
1.33.2	How to set the origin point reference for EBL OFFSET	1-39
1.34	How to Measure Range and Bearing Between Two Targets	1-39
1.35	How to Off-Center the Display	1-42
1.36	Target Trails	1-43
1.36.1	True or relative trails	1-43
1.36.2	Trail time	1-44
1.36.3	Trail gradation	1-44
1.36.4	Trail level.....	1-45
1.36.5	Narrow trails (Non-IMO only)	1-45
1.36.6	How to hide the trails temporarily.....	1-45
1.36.7	Trail stabilization in true motion.....	1-45
1.36.8	How to erase/restart trails	1-45
1.36.9	How to prevent sea clutter in true trails.....	1-46
1.36.10	How to show/hide land trails (Non-IMO only).....	1-46
1.37	Target Analyzer (Non-IMO only)	1-47
1.37.1	How to activate/deactivate the target analyzer	1-48
1.38	Target Alarm	1-48
1.38.1	How to set a target alarm.....	1-49
1.38.2	How to mute the target alarm.....	1-49
1.38.3	How to deactivate a target alarm	1-49
1.38.4	How to change target alarm attributes	1-50
1.39	PI (Parallel Index) Lines	1-50
1.39.1	How to set the maximum number of lines to display.....	1-50
1.39.2	How to change PI line bearing and interval.....	1-51
1.39.3	How to change the PI line bearing reference	1-51
1.39.4	How to change the PI line orientation	1-51
1.39.5	How to reset the PI lines to default (ship's heading).....	1-52
1.39.6	How to change PI line length	1-52
1.40	Zoom.....	1-53
1.41	How to Use Marks.....	1-54
1.41.1	How to select a mark type.....	1-54
1.41.2	How to select the mark inscription position	1-55
1.41.3	How to select the mark color (non-IMO type only).....	1-55
1.41.4	How to inscribe marks.....	1-56
1.41.5	How to set origin mark stabilization.....	1-56
1.41.6	How to delete marks	1-56
1.41.7	How to hide the heading line marker.....	1-57
1.41.8	How to hide/show the stern mark.....	1-57
1.41.9	How to set up the own ship symbol.....	1-57

1.41.10	How to use the INS marker	1-58
1.41.11	How to show/hide radar map marks	1-58
1.41.12	How to set the barge marker	1-58
1.42	Drop Mark.....	1-59
1.42.1	How to inscribe a drop mark.....	1-59
1.42.2	How to erase drop marks	1-59
1.43	How to Adjust Brilliance of On-screen Data	1-60
1.43.1	How to change color palettes	1-60
1.43.2	How to change the echo color	1-61
1.44	How to Display and Set Up Navigational Data	1-62
1.44.1	How to set up the navigational data	1-62
1.44.2	How to display navigational data	1-62
1.45	How to Use the Information Box.....	1-63
1.46	Interswitch	1-64
1.46.1	How to display antenna information	1-64
1.46.2	How to preset antenna and display combinations	1-64
1.47	Performance Monitor	1-66
1.47.1	How to activate/deactivate the performance monitor	1-66
1.47.2	How to check the radar's performance.....	1-67
1.48	How to Change the Reference Position	1-68
1.49	Anchor Watch	1-70
1.50	Alerts	1-70
1.50.1	What is an Alert?	1-70
1.50.2	How to Interpret the ALERT Box	1-71
1.50.3	How to acknowledge an alert	1-72
1.50.4	How to silence the alert buzzer	1-72
1.50.5	Alert list.....	1-72
1.50.6	Alert icons and their meanings	1-74
1.50.7	Responsibility Transfer Alert	1-75
1.50.8	How to adjust the alert sound level	1-75
1.51	How to Select a Display Mode (For Non-IMO types Only)	1-76
1.52	How to Manage SD-Card Data.....	1-77
1.52.1	How to access the SD-Card menu	1-77
1.52.2	How to save data.....	1-77
1.52.3	How to read (load) data	1-77
1.52.4	How to delete data	1-77
2.	RADAR OBSERVATION	2-1
2.1	General.....	2-1
2.1.1	Minimum and maximum ranges	2-1
2.2	False Echoes.....	2-3
2.3	SART (Search and Rescue Transponder).....	2-6
2.3.1	SART description	2-6
2.3.2	How to show SART marks on the radar display.....	2-6
2.3.3	General remarks on receiving SARTs.....	2-7
2.4	RACON.....	2-8
2.5	Radar Target Enhancer (RTE)	2-8
3.	TARGET TRACKING (TT).....	3-1
3.1	Precautions for Target Tracking Usage.....	3-1
3.2	TT Controls.....	3-2
3.3	TT Box Overview	3-2
3.4	How to Select the TT Mode.....	3-2
3.5	How to Acquire and Track Targets.....	3-3
3.5.1	How to manually acquire targets	3-3
3.5.2	How to automatically acquire targets	3-4

TABLE OF CONTENTS

3.6	How to Enter Own Ship Speed	3-4
3.6.1	Echo-referenced speed input	3-4
3.7	How to Cancel Target Tracking	3-5
3.7.1	How to cancel tracking for individual TT targets	3-5
3.7.2	How to cancel tracking for all TT targets	3-6
3.8	Lost Target	3-6
3.8.1	How to set the lost target filter	3-6
3.8.2	How to enable/disable the lost target alert	3-7
3.9	TT Symbols and Attributes	3-7
3.9.1	TT symbols	3-7
3.9.2	How to adjust symbol brilliance	3-8
3.9.3	How to set the symbol color	3-8
3.10	How to Display/Remove Target Data	3-9
3.10.1	How to display target data	3-9
3.10.2	How to remove target data	3-9
3.10.3	How to display, hide and sort the target list	3-10
3.10.4	How to use the target name feature (Non-IMO only)	3-11
3.11	Vector Modes	3-12
3.11.1	Description of vectors	3-12
3.11.2	How to change the vector length (time)	3-14
3.12	Past Position Display	3-14
3.12.1	How to display past position points and select the past position plotting interval	3-14
3.12.2	How to select the number of past position points to be displayed	3-14
3.13	Set and Drift	3-15
3.14	CPA/TCPA Alarm	3-16
3.14.1	How to set the CPA and TCPA ranges	3-16
3.14.2	How to acknowledge the TT CPA/TCPA alarm	3-16
3.15	Acquisition Zone	3-17
3.15.1	How to activate the first acquisition zone (AZ1)	3-17
3.15.2	How to set a polygon acquisition zone (AZ2)	3-18
3.15.3	How to sleep/deactivate an acquisition zone	3-18
3.15.4	How to acknowledge the acquisition zone alert	3-18
3.15.5	How to change the acquisition zone reference	3-19
3.15.6	How to set acquisition zone shape and stabilization	3-19
3.16	TT System Messages	3-20
3.17	TT Simulation Mode	3-21
3.18	Criteria for Tracking Target Selection	3-22
3.19	Factors Affecting TT Functions	3-23
4.	AIS OPERATION	4-1
4.1	Controls for AIS	4-3
4.2	AIS Symbols	4-4
4.3	How to Filter AIS Objects	4-8
4.4	How to Activate AIS Targets	4-8
4.4.1	How to activate specific targets manually	4-8
4.4.2	How to enable/disable the AIS auto activate function	4-9
4.4.3	How to limit the functions of the AIS auto activate function	4-9
4.5	How to Sleep AIS Targets	4-10
4.5.1	How to sleep individual activated AIS targets	4-10
4.5.2	How to sleep all activated AIS targets	4-10
4.6	How to Set Up For a Voyage	4-10
4.7	How to Display AIS Object Data	4-12
4.7.1	Basic AIS data	4-12
4.7.2	Expanded AIS data	4-13
4.7.3	How to remove AIS data from the display area	4-13

4.8	How to Change AIS Symbol Attributes.....	4-14
4.8.1	How to adjust the AIS symbol brilliance	4-14
4.8.2	How to change the AIS symbol color	4-14
4.8.3	How to change the ATON symbol color	4-14
4.9	Past Position Display.....	4-15
4.9.1	How to set the past position plotting interval	4-15
4.9.2	How to select the number of past position points to display.....	4-15
4.9.3	Past position display orientation	4-15
4.9.4	Stabilization in true motion	4-15
4.10	AIS Lost Object.....	4-16
4.10.1	How to set the AIS lost object filter.....	4-16
4.10.2	How to enable/disable the AIS lost alert.....	4-17
4.11	ROT Setting.....	4-17
4.12	AIS CPA/TCPA Alarm	4-18
4.12.1	How to set the CPA and TCPA ranges	4-18
4.13	How to Associate TT and AIS Targets	4-19
4.14	How to View Own Ship Data	4-20
4.15	How to Use AIS Messages.....	4-21
4.15.1	How to create and save messages	4-21
4.15.2	How to transmit messages	4-22
4.15.3	How to view messages.....	4-22
4.15.4	How to automatically display received messages	4-25
4.16	AIS System Messages	4-26
5.	VIDEO PLOTTER OPERATION	5-1
5.1	Orientation Modes	5-1
5.2	Radar Map.....	5-1
5.2.1	How to show/hide the radar map.....	5-1
5.2.2	Radar map marks.....	5-2
5.3	How to Align the Radar Map.....	5-2
5.3.1	How to disable the map alignment	5-3
5.4	Own Ship's Track	5-4
5.4.1	How to set the plotting interval	5-4
5.4.2	How to set the own ship track color.....	5-4
5.4.3	How to delete the own ship track	5-5
5.5	How to Use Waypoints	5-6
5.5.1	How to enter waypoints	5-6
5.5.2	How to erase waypoints	5-7
5.5.3	How to display the waypoint list	5-7
5.5.4	How to show/hide the waypoint name/number.....	5-7
6.	MAINTENANCE, TROUBLESHOOTING	6-1
6.1	Periodic Maintenance Schedule	6-2
6.2	How to Replace the Fuse	6-3
6.3	Life Expectancy of Major Parts.....	6-3
6.4	Trackball Maintenance	6-4
6.5	Easy Troubleshooting.....	6-4
6.6	Advanced-level Troubleshooting	6-5
6.7	Diagnostics	6-7
6.8	Fallback Arrangements.....	6-8
APPX. 1	MENU TREE	AP-1
APPX. 2	LONGITUDE ERROR TABLE (96 NM SCALE).....	AP-8
APPX. 3	ALERT CODES, MESSAGES AND MEANINGS.....	AP-10
APPX. 4	DATA COLOR AND MEANING	AP-21

TABLE OF CONTENTS

APPX. 5 ABBREVIATIONS.....	AP-22
APPX. 6 SYMBOLS.....	AP-27
APPX. 7 PARTS LOCATION	AP-34
APPX. 8 RADIO REGULATORY INFORMATION	AP-41
SPECIFICATIONS	SP-1
INDEX.....	IN-1

FOREWORD

A Word to the Owner of FAR-1513/FAR-1518 Series

Congratulations on your choice of the FURUNO FAR-1513/FAR-1518 series of radars. We are confident you will see why FURUNO has become synonymous with quality and reliability.

Since 1948, FURUNO Electric Company has enjoyed an enviable reputation for innovative and dependable marine electronics equipment. This dedication to excellence is furthered by our extensive global network of agents and dealers.

Your radar is designed and constructed to meet the rigorous demands of the marine environment. However, no machine can perform its intended function unless installed, operated and maintained properly. Please carefully read and follow the recommended procedures for operation and maintenance.

We would appreciate hearing from you, the end-user, about whether we are achieving our purposes.

Thank you for considering and purchasing FURUNO equipment.

Features

- Two methods of operation are available: RCU-028 (standard supply control unit) and RCU-030 (optional trackball unit). The ergonomically designed palm rest on the RCU-030 makes it easy to use.
- Simple operation with “point-and-click” menu functionality.
- All functions can be accessed using only the trackball unit.
- TT, AIS, Radar Map and Interswitch are supplied as standard.
- CPA/TCPA alarms.
- Targets activate the user-set alarm zone when entering or exiting the zone.
- The target analyzer function helps to find targets in high noise areas (rain/snow) or where there is interference from surface reflections.
- FAR-1518 and FAR-1528 comply with MED 2014/90/EU and also the following directives: IEC62388, IEC 62288 Ed. 3, IMO MSC. 192(79).
FAR-1513 and FAR-1523 comply with the RE Directive 2014/53/EU.

Signal processing functions

This radar has the signal processing functions listed in the table below.

Function	Description	Section
Interference rejector	Suppresses interference by other radars. Interference received simultaneously from multiple radars may be difficult to reduce.	section 1.21
Echo stretch	Enlarges target echoes, especially small echoes. Suppress interference, sea clutter and rain clutter before using echo stretch, to prevent enlargement of unwanted echoes.	section 1.22
Echo averaging	The radar samples echoes with each scan. Targets that show a large change with each scan are judged as clutter and are reduced to display only echoes from legitimate targets.	section 1.23
Automatic clutter elimination	Discriminates clutter from the radar echo, then reduces the clutter automatically.	section 1.24
Noise rejector	Reduces white noise then improves the on-screen S/N ratio by processing the weighted moving average filter for the received echoes in the range direction. Use this function with caution. Weak target echoes may disappear from the screen or the range resolution may worsen.	section 1.25

Program numbers

Software	Program No.	Remarks
SPU	0359344-02.**	Processor Unit
KEY	0359348-01.**	Control Unit
PM	0359296-01.**	Performance Monitor

** denotes minor modifications.

For further software information, please access the following URL:

<http://www.furuno.com/en/merchant/radar/FAR-15x8/>

CE/UKCA declaration

With regards to CE/UKCA declarations, please refer to our website (www.furuno.com), for further information about RoHS conformity declarations.

Disclosure of Information about China RoHS

With regards to China RoHS information for our products, please refer to our website (www.furuno.com).

SYSTEM CONFIGURATION

FAR-1513(-BB), FAR-1523(-BB)

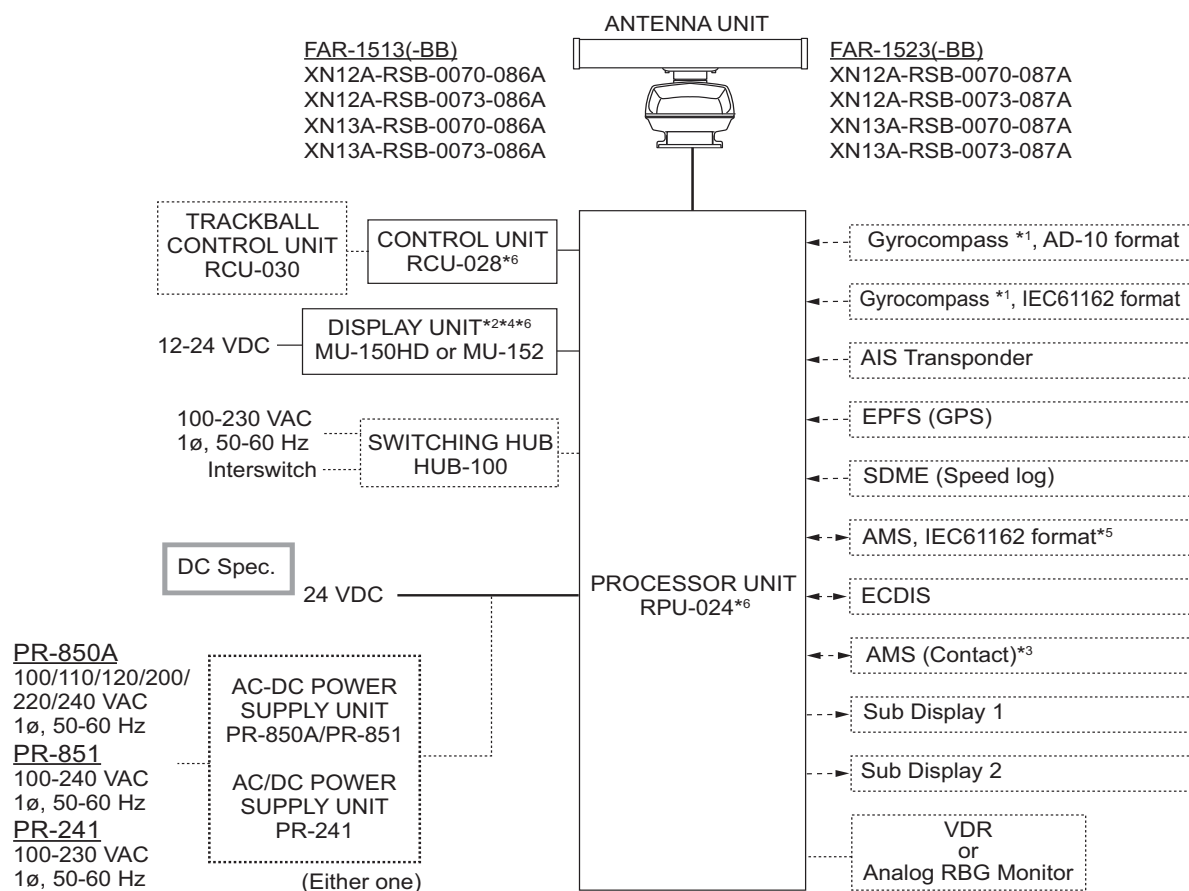

— : Standard supply
 : Optional or local supply

Equipment category

Unit	Category
Antenna	Exposed to the weather
Other units	Protected from the weather

*1: The gyrocompass must also have an update rate that is adequate for the ship's rate of turn. The update rate must be better than 40 Hz (HSC) or 20 Hz (conventional vessel).

*2: This monitor has been approved by the IMO for CAT 3. If a different monitor is to be used on IMO vessels, its effective diameter must meet the applicable Category requirements (CAT 3: Effective diameter 180 mm or higher; CAT 2: Effective diameter 250 mm or higher). For installation, operation and viewing distance of other monitors, see their respective manuals. For BB types, a monitor is to be prepared by the user.

*3: Characteristics of contact output for AMS (Alert Management System):

- (Load current) 250 mA
- (Polarity) Normally Open: 2 ports, Normally Close: 2 ports

*4: Standard supply with FAR-1513/FAR-1523 only.

*5: The ALR format is not BAM-compliant and shall not be used for new installation. It may be used for retrofitting on ships-in-operation only.

*6: DVI/USB Repeater required to extend the distance between the Processor Unit, Display Unit and/or Control Unit.

FAR-1518(-BB), FAR-1528(-BB)

NOTICE FOR FAR-1518(-BB)/FAR-1528(-BB)

The radar(s) must be interconnected to the following type approved sensors:

- Gyrocompass meeting requirements of the IMO resolution A.424(XI).
- EPFS meeting the requirements of the IMO resolution MSC.112(73).
- SDME meeting the requirements of the IMO resolution MSC.96(72).

The radar may be interconnected via HUB-100 to other FURUNO processing units having approved LAN ports.

The following sentences cannot be used for installations on SOLAS vessels: BWC, BWR, DBK, GBS, HDG, HDM and TLL.

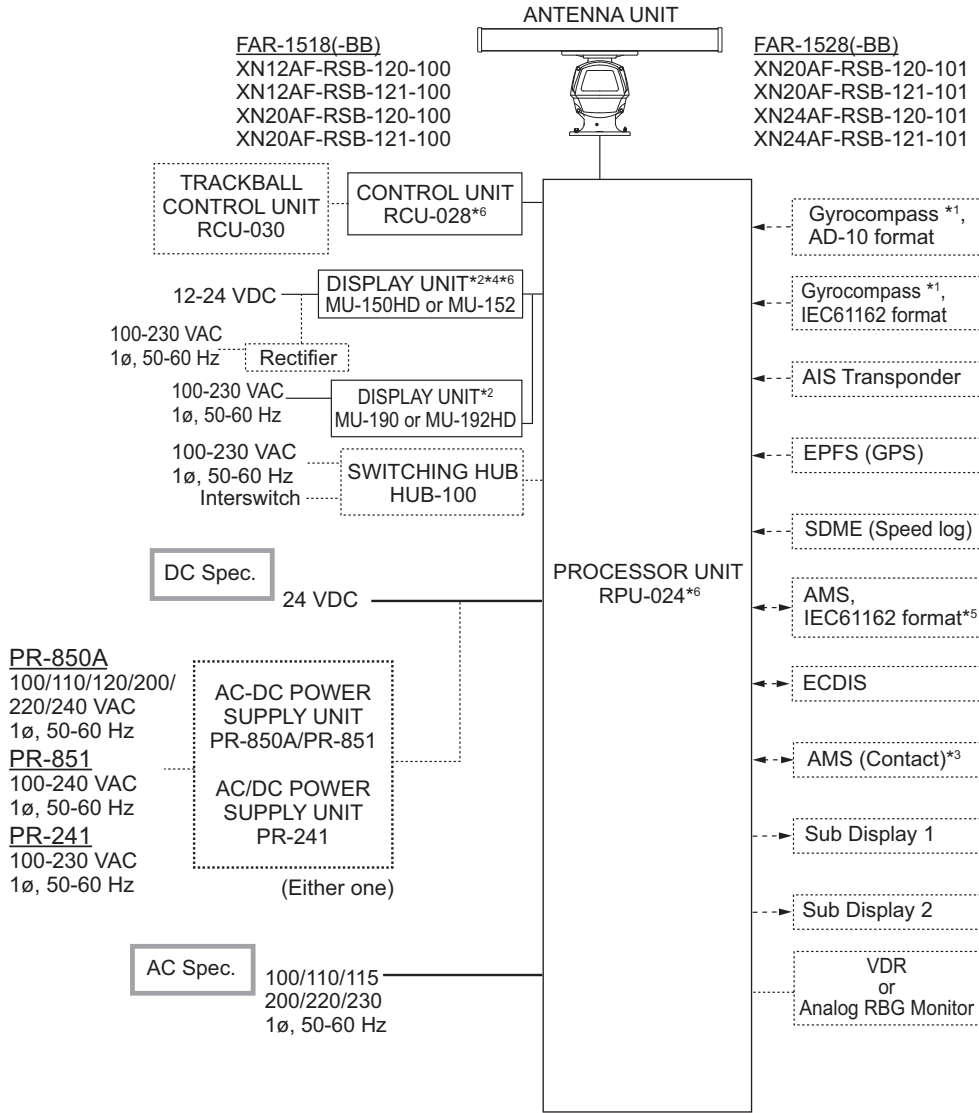

Equipment category

Unit	Category
Antenna	Exposed to the weather
Other units	Protected from the weather

- *1: The gyrocompass must also have an update rate that is adequate for the ship's rate of turn. The update rate must be better than 40 Hz (HSC) or 20 Hz (conventional vessel).
- *2: This monitor has been approved by the IMO: MU-150HD, MU-152 for CAT 3, MU-190 and MU-192HD for CAT-2. If a different monitor is to be used on IMO vessels, its effective diameter must meet the applicable Category requirements (CAT 3: Effective diameter 180 mm or higher; CAT 2: Effective diameter 250 mm or higher). For installation, operation and viewing distance of other monitors, see their respective manuals. For BB types, a monitor is to be prepared by the user.
- *3: Characteristics of contact output for AMS (Alert Management System):
 - (Load current) 250 mA
 - (Polarity) Normally Open: 2 ports, Normally Close: 2 ports
- *4: Standard supply with FAR-1518/FAR-1528 only.
- *5: The ALR format is not BAM-compliant and shall not be used for new installation. It may be used for retrofitting on ships-in-operation only.
- *6: DVI/USB Repeater required to extend the distance between the Processor Unit, Display Unit and/or Control Unit.

Compatible approved monitors

The monitors listed in the following table have been approved by the IMO. If a different monitor is to be used on IMO vessels, its effective diameter must meet the applicable Category requirements.

- CAT 2 and CAT 2H: effective diameter of 250 mm or higher
- CAT 3: effective diameter of 180 mm or higher

Category	Manufacturer	Model	Viewing distance
CAT 2 and CAT 2H	FURUNO	MU-190	1.02 m
		MU-192HD	1.02 m
	Hatteland Display	JH 19T14 FUD	1.02 m
		JH 19T14 MMD	1.02 m
		JH 20T17 FUD	0.88 m
		HD 19T22 FUD	1.02 m
CAT 3	FURUNO	MU-150HD	1.02 m
		MU-152	1.02 m
	Hatteland Display	JH 15T17 FUD	1.02 m
		HD 15T22 FUD	1.02 m

For installation and operation of other monitors, see the respective manuals.

For BB types, a monitor units is prepared by the user.



This page is intentionally left blank.

1. OPERATIONAL OVERVIEW

1.1 Controls

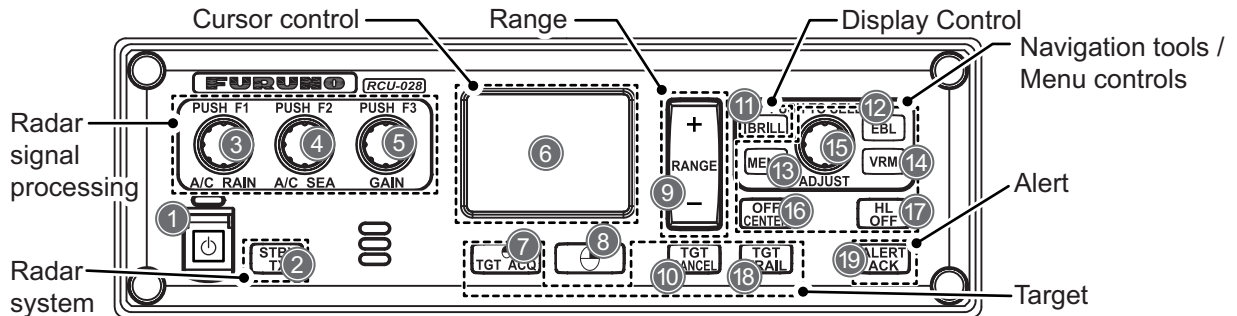
Control unit RCU-028



No.	Key/Control	Description
1	Power switch	Press to turn the radar on. Long press to turn the radar off. Shown as  in procedures.
2	STBY/TX	Press to switch between STBY (Stand-by) and TX (Transmit) modes.
3	A/C RAIN/F1	<ul style="list-style-type: none"> Push: Activates the F1 registered function. Rotate: Adjusts rain clutter manually (default setting).
4	A/C SEA/F2	<ul style="list-style-type: none"> Push: Activates the F2 registered function. Rotate: Adjusts sea clutter manually (default setting).
5	GAIN/F3	<ul style="list-style-type: none"> Push: Activates the F3 registered function. Rotate: Adjusts gain manually (default setting).
6	Touchpad	Moves the cursor.
7	Left button  / TGT ACQ	<ul style="list-style-type: none"> Selects menu item. TT mode: Selects or acquires the cursor-highlighted echo as a target. AIS mode: Selects or activates the cursor-highlighted object
8	Right button 	Opens the cursor-selected context menu; closes open menus.
9	Range +/-	Selects the display range.
10	TGT CANCEL	<ul style="list-style-type: none"> TT mode: Deactivates tracking for the cursor-selected target. AIS mode: Sleeps the selected object. Long press: Sleeps/deactivates all TT targets.
11	BRILL	Adjusts the screen brilliance.
12	EBL	Activates/deactivates the EBL cursor.
13	MENU	Opens the main menu; closes all open menus.
14	VRM	Activates/deactivates the VRM cursor.
15	ADJUST	<ul style="list-style-type: none"> Rotate: Adjusts settings for the cursor-selected box/icon. Highlights menu items. Push: Selects highlighted menu item; applies settings; moves the cursor to the next character/digit.
16	OFF CENTER	Moves the radar display off center.
17	HL OFF	Hides heading line when pressed and held.
18	TGT TRAIL	<ul style="list-style-type: none"> Press: Changes the trail time. Long press: Erases trails.
19	ALERT ACK	<ul style="list-style-type: none"> Acknowledges alerts. Silence the alarm buzzer.

1. OPERATIONAL OVERVIEW

Trackball unit RCU-030 (Option)

The optional trackball unit can be used to control most features of this radar.

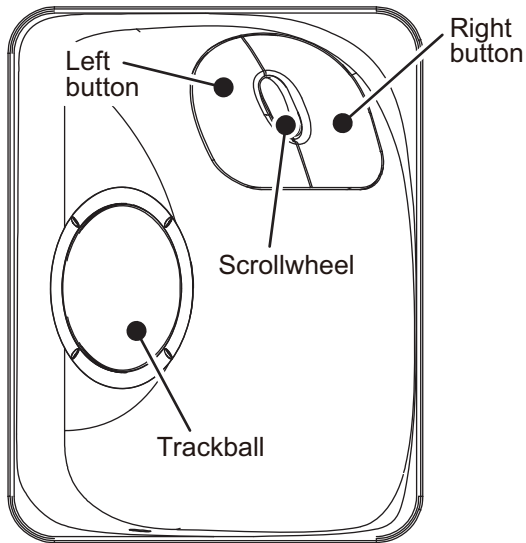

- Trackball**
- Moves cursor.
 - Highlights an object (target echo, menu item, etc.)
- Scrollwheel**
- Selects menu options.
 - Sets numeric data.
 - Sets menu box slide bars (GAIN, etc.)
- Note:** The scrollwheel does not have a “push” function.
- Left Button**
- Does the operation related to the selected object.
 - Confirms the operation for the selected object.
- Right Button**
- Cancels current action.
 - Opens/closes menu boxes.

Standards used in this manual

This manual uses the following standards:

Terminology standards	Meaning
Select	<ul style="list-style-type: none"> • Using the Touchpad or trackball, move the cursor over the item to be “selected”. • Rotate the ADJUST knob to highlight the item to be “selected”.
Left-click	Press the left button on the RCU-030 unit.
Right-click	Press the right button on the RCU-030 unit.
Left button	Refers to the left button (⊖) on the RCU-028 control unit.
Right button	Refers to the right button (⊕) on the RCU-028 control unit.
Control unit	Refers to the RCU-028 control unit.
Trackball	Refers to the RCU-030 control unit.
Open the [MAIN MENU].	<ul style="list-style-type: none"> • Press the MENU key to open the main menu. • Select the [MENU] box, then press the left button or left-click.
Close the menu.	<ul style="list-style-type: none"> • Press the MENU key to close the menu. (Closes all open menus.) • Select the operational display area, then press the right button or right-click. • Select the [MENU] box, then press the left button or left-click.

For the sake of brevity, the procedures in this manual use the terms “Open the [MAIN MENU].” and “Close the menu.”

Most operations can be done with either the RCU-030 trackball unit or the RCU-028 control unit.

Throughout this manual, procedures are outlined using the RCU-028 control unit, unless otherwise specified.

1.2 How to Turn the Radar On/Off

The **POWER** switch  is located at the bottom left corner of the control unit. Open the **POWER** switch cover and press the switch to turn the radar system on. To turn the system off, press and hold the **POWER** switch. The screen shows the bearing scale and digital timer for approximately 30 seconds after power is applied. The timer counts down three minutes of warm-up time. During this period, the magnetron (transmitter tube) is warmed for transmission. When the timer has reached 0:00, the indication "ST-BY" appears at the screen center, meaning the radar is now ready to transmit pulses.

In the stand-by condition, markers, rings, maps, etc. are not shown. Further, TT and AIS are not shown. In the warm-up and stand-by conditions, [ON TIME] and [TX TIME] are counted in hours and tenths of an hour, appearing at the screen center.

Note 1: Do not turn on the power directly after it has been turned off. Wait several seconds before you reapply the power, to be sure the radar starts up properly.

Note 2: Parameters set on the menus are stored in a non-volatile memory (flash memory), and are preserved when the power is turned off.

Note 3: The screen refreshes slower in low ambient temperature.

1.3 How to Adjust the Brilliance

The screen brilliance can be adjusted as shown below. To change color tones, see "How to change color palettes" on page 1-60.

Note: External monitor brilliance is not adjustable from the radar. Refer to the external monitor's Operator's Manual for how to adjust brilliance.

From the control unit

1. Press the **BRILL** key. The cursor is automatically moved to the [BRILL] box.



The brilliance bar shows the brilliance level.

2. Use the **ADJUST** knob to adjust the brilliance as appropriate. Turn clockwise to increase the brilliance, counter-clockwise to reduce the brilliance.
3. Push the **ADJUST** knob to complete the procedure.

From the on-screen box

1. Use the Touchpad to select the [BRILL] box, then press the **left button**.
2. Use the **ADJUST** knob to adjust the brilliance as appropriate. Turn clockwise to increase the brilliance, counter-clockwise to reduce the brilliance.
3. Push the **ADJUST** knob to complete the procedure.

1.4 Display Indications

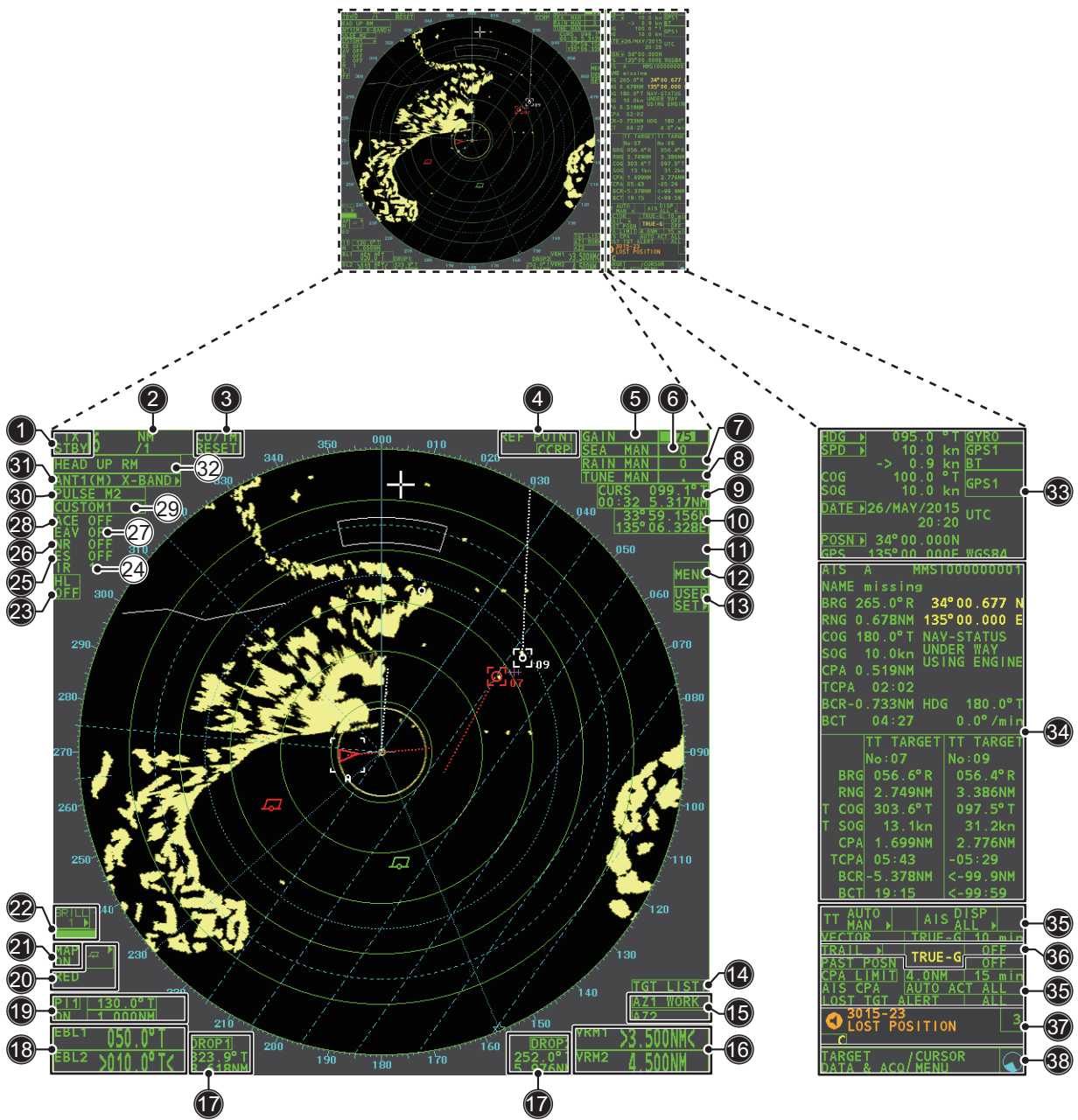

No.	Name	Description
1	STBY/TX box	Switches between standby and transmit mode.
2	Range box	Changes the radar range.
3	CU/TM Reset box	Resets display when using Course Up/True Motion presentation mode.
4	REF POINT box	Changes the reference point.
5	GAIN box	Adjusts the GAIN level.
6	SEA box	Adjusts the A/C SEA settings.
7	RAIN box	Adjusts the A/C RAIN settings.
8	TUNE box	Adjusts the tuning for the receiver.
9	Cursor information box	Displays the range, bearing and TTG to cursor position.
10	Cursor position box	Displays the cursor's current co-ordinates.
11	MAP ALIGN box	Enables/disables radar map alignment.
12	MENU box	Opens the [MAIN MENU].

No.	Name	Description
13	USER SET ►	Loads/saves user specific settings.
14	TGT List ►	Displays the target list; displays the [TARGET LIST] menu.
15	AZ box	Activates/deactivates the acquisition zone(s).
16	VRM box	Activates/deactivates the VRM.
17	DROP box	Displays drop mark data.
18	EBL box	Activates/deactivates the EBL.
19	PI Line box	Activates/deactivates the PI lines.
20	MARK boxes	Selects mark icons; displays mark information.
21	MAP box	Activates/deactivates the radar map.
22	BRILL box	Adjusts screen brilliance; opens the [BRILLIANCE] menu.
23	HL OFF box	Hides the heading line.
24	IR box	Activates/deactivates the interference rejector function.
25	ES box	Activates/deactivates the echo stretch function.
26	NR box	Activates/deactivates the noise reduction function.
27	EAV box	Activates/deactivates the echo averaging function.
28	ACE box	Activates/deactivates the ACE function.
29	CUSTOMIZE ECHO box	Cycles through echo filtering customizations; open the [CUSTOMIZE ECHO] menu.
30	PULSE box	Cycles through pulse settings.
31	ANTENNA SELECT box	Selects the antenna to use. Only antennas connected to the same network are displayed and selectable.
32	PRESENTATION MODE box	Cycles though display presentation modes.
33	Own ship details box.	Shows various data regarding own ship. Contains speed*, heading and position context menus. *: Speed is displayed as a negative value when the vessel is using reverse thrust.
34	Information box	<ul style="list-style-type: none"> • Displays currently open menu. • Displays various information, such as received messages, TT/AIS target/object information and navigational data.
35	TT/AIS box	<ul style="list-style-type: none"> • Activates/deactivates TT/AIS functions. • Access TT/AIS functions such as filters and association. • Access the [AIS TARGET MENU]. • Access the [TT MENU]. • Displays/sets target vector time and orientation.
36	TRAIL box	<ul style="list-style-type: none"> • Sets target trail time. • Sets past position plotting interval. • Erases trails. • Opens [TRAIL] menu.
37	Alert box	Displays alert information and icons.
38	Guidance box	Displays operational guidance for selected item. <ul style="list-style-type: none"> • Left side: guidance for left button/left-click. • Right side: guidance for right button/right-click.
	Working indicator 	Rotates clockwise when the system is working properly. <u>Picture freeze</u> If the picture freezes, the picture is not updated. Restart (turn off, then on) the unit to restore normal operation.

Display specifications

- Nominal viewing distance: 0.75 m
- Text height: 2.67 mm
- Text width: 2.08 mm

1.5 Menu Operations

1.5.1 How to access the main menu

The main menu can be accessed from the control unit or from the on-screen box. The [MAIN MENU] appears in the text area on the right side of the screen.

From the control unit

Press the **MENU** key on the control panel.

From the on-screen box

Select the [MENU] box, then press the **left button**.

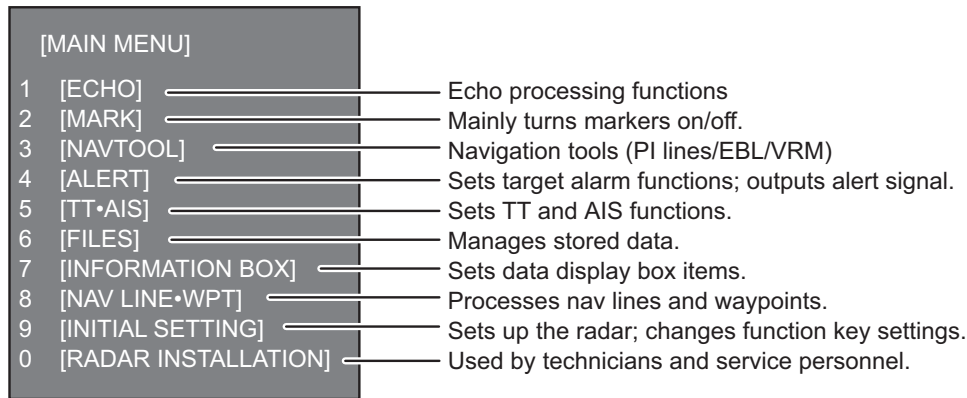

1.5.2 How to operate the menus

1. Open the [MAIN MENU].
2. Rotate the **ADJUST** knob to select a layer one ([MAIN MENU]) menu item, then push the **ADJUST** knob. The menu item currently selected is highlighted and shown in reverse video.

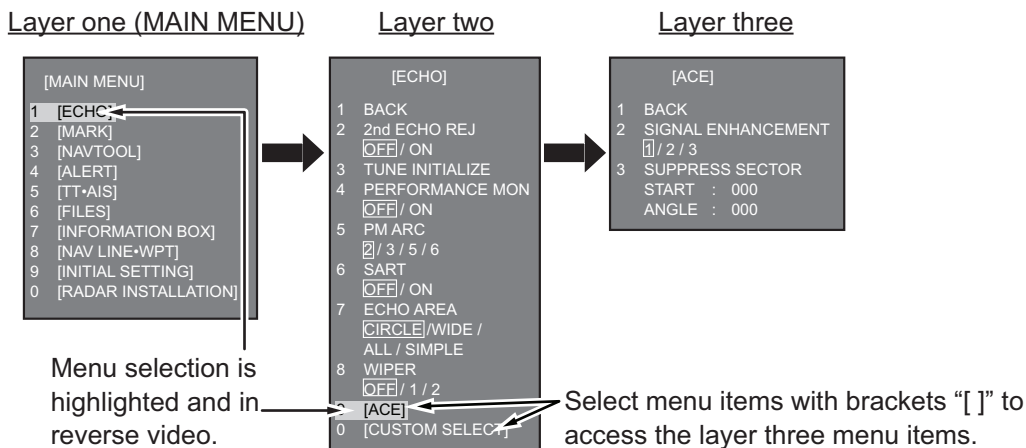

3. Rotate the **ADJUST** knob to select the layer two menu item, then push the knob. When required, repeat this step to access the layer three menu. In the above example, [ACE] is selected, which opens the layer three [ACE] menu.
4. Rotate the **ADJUST** knob to change the selected setting, then push the knob.
5. Close the menu.

1.6 How to Use the On-screen Box Menu

Some radar functions can be accessed using the on-screen box menu. A "▶" at the right side of an on-screen box which indicates that there is a box menu.



There are two methods for on-screen box menu selection.

- RCU-028: Use the Touchpad to select the on-screen box, then press the **right button**.
- RCU-030: Use the trackball unit (RCU-030) to select the on-screen box, then right-click.

The procedure outlined below uses the RCU-028 control unit.

To operate the radar using the on-screen boxes, do the following:

1. Select the desired box.

Note: The cursor changes shape according to its location. It is an arrow () when placed outside the operational display area and when inside the operational display area, it is a cross ().

For the purpose of this example, select the [BRILL] box, at the bottom left corner of the display.

When a box is correctly selected, its color changes (colors depending on selected color palette) and the guidance box at the bottom right corner shows operational guidance. The operational guidance shows the function of the **left button** and **right buttons**, with a diagonal line separating the information.

Place cursor here, then press the **left button** to change brilliance preset, **right button** to open the [BRILL] menu.



The [BRILL] box, for example, displays the operational guidance "BRILL SELECT / BRILL MENU". In this case you would press the **left button** to select a preset palette (See "How to change color palettes" on page 1-60) or press the **right button** to open the [BRILL] menu.

2. Press the **left button** to cycle through preset palettes.
3. Rotate the **ADJUST** knob to adjust the display brilliance.
4. The box menu attached to the [BRILL] box is the [BRILLIANCE] menu. To open the box menu, press the **right button**.
5. Select the desired menu item, then push the **ADJUST** knob.
6. Select the appropriate option, then push the **ADJUST** knob.
7. Close the menu.

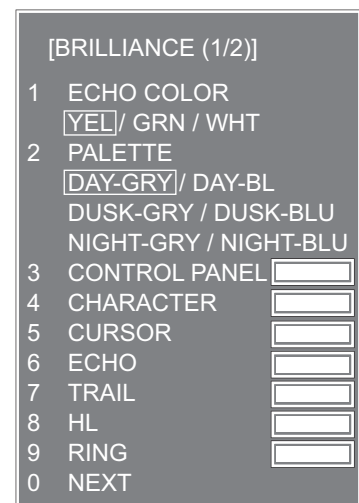

1.7 How to Use the CURSOR Menu

Functions that require the use of the cursor, such as EBL offset and zoom, can be activated directly from the guidance box or from the [CURSOR] menu, either method with the cursor inside the operational display area. Below is the procedure for choosing cursor-related functions from the [CURSOR] menu.

1. Select the operational display area, then press the **right button**.
The [CURSOR] menu appears.
2. Select the desired function, then push the **ADJUST** knob.
3. The guidance box shows "XX / EXIT" (XX = function selected). Use the Touchpad to place the cursor where desired.
4. Push the **ADJUST** knob to execute the function selected at step 3.
5. To quit the selected function, press the **right button** when the guidance box shows "XX / EXIT" (XX = function selected).

[CURSOR MENU 1/2]

2
 TARGET DATA / ACQ /
 TARGET CANCEL /
 TT TGT DATA / ACQ /
 REF MARK /
 EBL OFFSET /
 OFF CENTER /
 ZOOM /
 MARK DELETE /
 OWN TRACK DELETE /
 MAP ALIGN /
 TRAIL ERASER

[CURSOR MENU 2/2]

1 BACK
 2 TGT DATA/ACQ SETTING
 ANY / TT ONLY / AIS ONLY
 3 TGT CANCEL SETTING
 ANY / TT ONLY / AIS ONLY
 4 RANGE RING
 OFF/ON
 5 SLEEP ALL TGTS
 NO/YES

Menu Item	Description
TARGET DATA/ACQ	TT: Acquires target; displays data for selected tracked target. AIS: Activates sleeping AIS target; displays data for selected AIS target.
TARGET CANCEL	TT: Cancels tracking on selected tracked target. AIS: Sleeps selected AIS target.
TT TGT DATA/ACQ	Acquires selected echo as tracked target.
REF MARK	Inscribes reference mark, for target-based speed input.
EBL OFFSET	Offsets EBL to measure range and bearing between two targets.
OFFCENTER	Shifts screen center to selected location.
ZOOM	Zooms selected location.
MARK DELETE	Deletes selected mark (plotter mark, origin mark or waypoint mark).
OWN TRACK DELETE	Deletes own ship's tracks.
MAP ALIGN	Aligns charts (maps) with the radar picture.
TRAIL ERASER	Erases trails.
TGT DATA/ACQ SETTING	Change target tracking settings.
TGT CANCEL SETTING	Change target cancel settings.
RANGE RING	Show or hide the range rings.
SLEEP ALL TGTS	Select YES to sleep all AIS targets.

1.8 Cursor Data

Cursor data can be shown in latitude and longitude position or the cursor's X-Y co-ordinates.

Place cursor on the [CURSOR DATA] box at the right side of the display then press the **left button**. The data box shows the cursor information in the upper half and cursor location (latitude/longitude) is shown in the lower half.

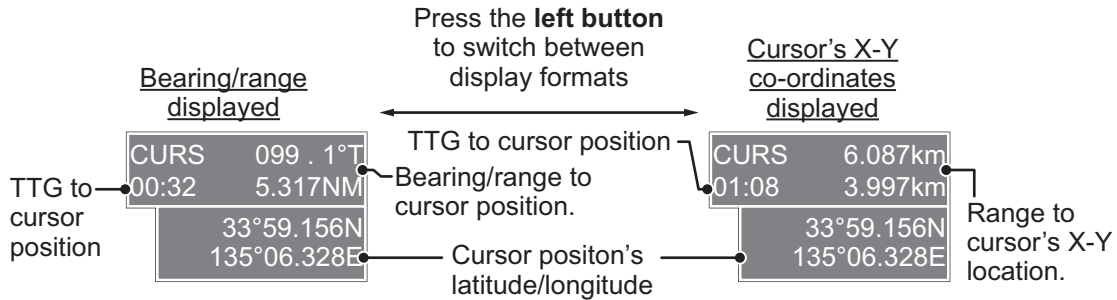

Note 1: For the X-Y co-ordinates display, the Y-axis is the heading line, the upper half of the screen is "plus" and the lower part of the screen is "minus". The X-axis is the port/starboard direction, starboard is "plus", port is "minus".

Note 2: When displaying latitude and longitude position and the cursor has been aligned (on the [CURSOR] menu), the indication "MAP ALIGN" appears at the right side of the screen (in yellow).

Note 3: Cursor data reads "- - -" when the cursor is placed outside the operational display area.

1.9 How to Set Up Function Keys

Some menu functions and menus can be assigned to a function key. This allows one-touch access to the assigned function or menu.

To activate an assigned function, press the corresponding function key (**F1**, **F2** or **F3**).

The **function keys** are preset with the following functions:

F1: A/C RAIN, **F2:** A/C SEA, **F3:** ACE (Gain).

You can change the function assigned to each key using the following procedure.

1. Open the [MAIN MENU].
2. Select [INITIAL SETTING], then push the **ADJUST** knob.
3. Select [FUNCTION KEY], then push the **ADJUST** knob.
4. Select [F1], [F2] or [F3] as appropriate, then push the **ADJUST** knob.
5. Referring to the table of available functions below, select a function category, then push the **ADJUST** knob.

Function category	Available function
ECHO	CUSTOM MENU, IR, ES, EAV, NOISE REJ, ANT SELECT, PULSE LENGTH, AUTO-SEA, AUTO-RAIN, TUNE SELECT, 2ND ECHO REJ, PM, SART, ECHO TRAIL, TRAIL T/R, WIPER, ACE, ACE HIGH SENSITIVITY
STD KEY	ALERT ACK, STBY TX, EBL OFFSET, PRESENTATION MODE, CU-TM RESET, VECTOR TIME, VECTOR MODE, TARGET LIST, BRILL, MARK-CURSOR, MARK-OS, MENU, RANGE UP, RANGE DOWN, ACQ, TARGET DATA, TARGET CANCEL
TT•AIS	TT-DISP, AIS-DISP, PAST POSN INTERVAL, REF MARK, CPA LIMIT, CPA, TCPA, AZ1, AZ2, AIS SCALED SYMBOL
DELETE DATA	MARK DELETE, MARK ALL DELETE, OWN TRACK DELETE, OWN TRACK ALL DELETE
OPERATION	ECHO AREA*, ECHO COLOR, RING(ON/OFF), ZOOM, MOB, ALARM1, ALARM2, TLL, MAP ALIGN

*: Non-IMO radars only.

6. Select the appropriate function to assign, then push the **ADJUST** knob.
7. Close the menu. Repeat the procedure as necessary to set up other function keys.

1.10 How to Customize Operation

Several operation items can be customized to suit your needs.

1. Open the [MAIN MENU].
2. Select [INITIAL SETTING], then push the **ADJUST** knob.
3. Select [OPERATION], then push the **ADJUST** knob.
4. Referring to the table below, select the appropriate menu item to customize.

Menu items	Description	Available settings
WHEEL DRIVE	Sets the direction of the wheel drive (scroll-wheel).	[NORMAL], [REVERSE]
KEY BEEP	Changes the key beep volume.	[OFF], [LOW], [MID], [HIGH]
OWN SHIP VECTOR	Select how the own ship vector is displayed.	[OFF], [HDG], [COURSE]
STERN UP RM	HEAD UP RM display is reversed.	[ON], [OFF]
GUIDANCE*	Turns operational guidance on/off.	[ON], [OFF]
SHUTTLE FERRY	Sets the shuttle ferry mode to use. Note: Shuttle ferry mode requires an external switch.	[OFF], [MODE1], [MODE2]
SENSITIVITY	Adjusts sensitivity for optional mouse/trackball.	[1], [2], [3], [4], [5]

*: Non-IMO radars only, available only for [SIMPLE] display mode. See section 1.51 for details regarding display modes.

5. Rotate the **ADJUST** knob to select the appropriate setting, then push the knob.
6. Close the menu.

Shuttle ferry mode

The shuttle ferry mode changes the orientation of the display when the external switch is turned on.

Note: Refer to the Installation Manual (IME-36380-x; x denotes version number) for switch installation.

There are two variations: Standard display ([SHUTTLE FERRY] is set to [OFF]) and reversed display ([SHUTTLE FERRY] is set to [MODE1] or [MODE2]).

When the display is reversed for shuttle ferry mode, the following changes also occur:

- Echoes are displayed 180° opposite to normal display.
- Bearing for speed data is re-calibrated to 180° opposite to normal.
- Wind direction based on speed input is re-calibrated to 180° opposite to normal.
- Where [Mode2] is selected, data input from the gyrocompass is re-calibrated to 180° opposite to normal.

Note: Gyrocompass data input is not re-calibrated for [Mode1].

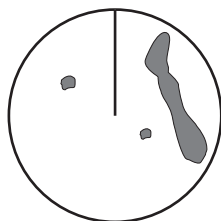

Standard display: Gyro input is displayed normally.

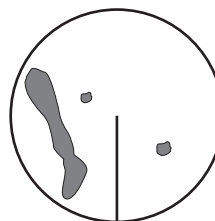

Reversed display: Gyro input is displayed in reverse.

1.11 How to Select the Interface for Heading Input

When a gyrocompass is connected, the ship's heading appears on the right side of the screen, in the data display area.

Heading input format can be selected as follows:

1. Place the cursor on the [HDG] box at the top-right of the screen, then press the **right button**. The [HDG] context menu appears.
2. Select [HDG SOURCE], then push the **ADJUST** knob.
3. Select [AD-10] or [SERIAL] as appropriate, then push the **ADJUST** knob.
This refers to the type of connection, [AD-10] is for AD-10 format (FURUNO original) connection, [SERIAL] is for serial connections.
4. Close the menu.

Note: The heading sensor must be able follow a minimum ROT of 20° per second. Heading sensors with a lesser capability may degrade the performance of echo averaging, trails and TT. The data refresh rate should also be as short as possible. If the refresh rate is too long, the ability to follow courses lessens, thereby affecting the performance of echo averaging, trails and TT.

1.12 How to Set Own Ship's Speed

The TT and azimuth stabilized presentation modes require own ship speed input and compass signal. The speed can be entered from a log (STW, SOG) or GPS (SOG) or manually on the menu.

Note: Where the own ship speed exceeds 99.9kn, the displayed speed is "99.9kn".

1.12.1 Automatic speed input (log or GPS navigator)

1. Select the [SPD] box at the top right corner of the screen, then press the **right button**. The [SPEED] box menu appears.
2. Select [SHIP SPEED], then push the **ADJUST** knob.
3. Select the appropriate source for automatic speed input, then push the **ADJUST** knob.

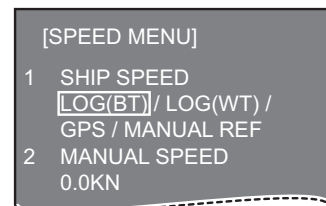

Selection	Explanation	Stabilization Mode
[LOG (BT)]*	Log, speed over ground (SOG)	Ground stabilization
[LOG (WT)]	Log, Speed Thru Water (STW)	Sea stabilization
[GPS]	Speed input by GPS navigator	Ground stabilization
[MANUAL]	Manually input speed	Sea stabilization
[REF]	Echo-referenced speed input	Ground stabilization

*: Set and drift may be required to display [LOG (BT)] correctly in deep waters. To change set and drift do the following:

- 1) From the [SPEED MENU], select [SET DRIFT], then push the **ADJUST** knob.
 - 2) Select [ON], then push the **ADJUST** knob.
 - 3) Select the set angle, then push the **ADJUST** knob.
 - 4) Select the drift speed, then push the **ADJUST** knob.
4. Close the menu.

Notes on speed input

It should be noted that in determining a target's aspect by radar, the calculation of its true track is dependent on the choice and accuracy of the own ship's course and speed input. A ground-stabilized target plot may accurately calculate the ground track of the target, but the target's heading may be significantly different from its track when experiencing set, drift or leeway. Similarly, a sea stabilized target plot may be inaccurate when own ship and the target, are experiencing different rates of set, drift or lee-way.

- IMO Resolution A.823(19) for TT recommends that a speed log to be interfaced with a TT should be capable of providing through-the-water speed (forward speed).
- Be sure not to select a [LOG] option when a speed log is not connected. If the log signal is not provided, the ship speed readout at the top of the screen will be blank. In the event of a log error, enter speed manually.
- The [SPD] is shown as "*. * kn" and the label "LOST LOG(WT) SIG" or "LOST LOG(BT) SIG" (in yellow-orange) appears and the alert buzzer sounds if no log signal is present for 30 s.
- When the speed input in use is interrupted or lost, the system automatically changes to another speed input (stabilization reference) and outputs the "SPD SOURCE CHG" alert.
- On the IMO type with AIS in use, [MANUAL] and [REF] are shown in gray to indicate they are not available for selection.
- A single-axis water log cannot measure speed when the wind is coming from the lee-way direction.

1.12.2 Manual speed input

If the speed log is not working, enter speed manually as below. In this case the speed data type is shown as "MANUAL" and is speed thru water (STW). Manual speed input is not available on the IMO radar when the AIS feature is active.

1. Select the [SPD] box at the top right corner of the screen, then press the **right button** to display the [SPEED] menu.
2. Select [SHIP SPEED], then push the **ADJUST** knob.
3. Select [MANUAL], then push the **ADJUST** knob.
4. Select [MANUAL SPEED], then push the **ADJUST** knob.
5. Rotate the **ADJUST** knob to set speed.
6. Push the **ADJUST** knob to confirm the new setting.
7. Close the menu.

1.13 How to Set the Own Ship Position

You can select the data source for own ship's position as follows:

1. Place the cursor on the [OS POSN] box in the data display area, then press the **right button**. The [OWN SHIP POSN] menu appears.
2. Select [NAV AID] or [MANUAL L/L] as appropriate, then push the **ADJUST** knob.
3. Select the appropriate setting, referring to the list below, then push the **ADJUST** knob.
 - [NAV AID]: Using navigational aids. Select the navigational aid in use. Available options are: [GPS1], [GPS2], [LAN], [INS] or [DEAD RECKONING].
 - [MANUAL L/L]: Manual input of own ship co-ordinates.

Note 1: Where [NAV AID] is set to [DEAD RECKONING], the indication "DR" appears at the bottom of the [OS POSN] box.

Note 2: Where [NAV AID] is set to [DEAD RECKONING] or [MANUAL L/L], the AIS function cannot be used.

4. To set [MANUAL L/L], do the following:
 - 1) Rotate the **ADJUST** knob to set the value.
 - 2) Push the **ADJUST** knob to move the cursor to the next digit.
 - 3) Repeat steps 1 and 2 to set the latitude and longitude.
5. To share [OS POSN] data across the same network, do the following:
 - 1) Select [SIO DATA LAN OUTPUT], then push the **ADJUST** knob.
 - 2) Select [ON], then push the **ADJUST** knob to share data. To disable [OS POSN] data sharing, select [OFF], then push the **ADJUST** knob.

Note: A navigational aid must be selected at [NAV AID] to share [OS POSN] across the same network.

6. Close the menu.

1.14 User Settings

The user functions shown in the table below can be reset to their default settings by enabling the [PILOT SETTING] option in the [USER SET] menu. Functions not shown in the table below maintain their previous setting.

The unit can store two separate user settings, for the functions listed below, in the internal memory. These settings can also be recalled. Functions not shown in the table below cannot be stored or recalled.

Function		Setting(s)	Menu/On-screen box
GAIN		Maintained as per previous setting.	[GAIN] box
SEA		Maintained as per previous setting.	[SEA] box
RAIN		Maintained as per previous setting.	[RAIN] box
TUNE		[AUTO]	[TUNE] box
Range		[6 NM]	[RANGE] box
Range rings		[OFF]	[MAIN MENU] → [NAVTOOL] → [RANGE RING]
VRM1	Display	[ON]	[VRM1] box
	Distance	[0.250 NM]	
VRM2	Display	[ON]	[VRM2] box
	Distance	Maintained as per previous setting.	
EBL1	Display	[ON]	[EBL1] box
	Bearing	Maintained as per previous setting.	
	Reference	[TRUE]	
EBL2	Display	[OFF]	[EBL2] box
	Bearing	[000.0°]	
	Reference	[TRUE]	
PI Lines	Display	[OFF]	[PI Line] box
	Interval		
	Orientation		
	Bearing (True or Relative)		[MAIN MENU] → [NAVTOOL] → [PI LINE] → [PI LINE BEARING] * ¹
	Number of PI lines		[MAIN MENU] → [NAVTOOL] → [PI LINE] → [SET ALL PI LINE]
	Mode (Parallel or Perpendicular)		[MAIN MENU] → [NAVTOOL] → [PI LINE] → [PI LINE MODE]
Presentation Mode		[NORTH UP TM]	[PRESENTATION MODE] box
Stabilization mode (Sea/Ground)		[LOG(WT)] (Sea)	[SPEED] → [SHIP SPEED]
Off-centering		TM reset position	OFF CENTER key.* ²

1. OPERATIONAL OVERVIEW

Function		Setting(s)	Menu/On-screen box
Target trails	Display, time	[ON], [6 MIN]	[TRAIL MODE] box
	Mode	[TRUE]	[PAST POSN] box
<i>Continued on following page</i>			
<i>Continued from previous page</i>			
Vector mode		[REL]	[VECTOR] box
Vector time		[6 MIN]	
AZ1		[OFF]	[AZ1] box
AZ2		[OFF]	[AZ2] box
TT acquisition mode		[MAN50]	[TT TARGET] → [TT SELECT]
AIS display		[DISP ALL]	[AIS] box
Association		[ON] (TT < AIS)	[MAIN MENU] → [TT•AIS] → [ASSOCIATION] → [ASSOCIATION TGT]
Lost Target Alert		[OFF] (Disabled)	LOST TARGET ALERT box
CPA/ TCPA alarm	ON/OFF	[ON]	[CPA LIMIT] box
	CPA	[2 NM]	
	TCPA	[12 MIN]	

*1: This menu is not available for IMO type and the setting is fixed to [TRUE].

*2: Has the same effect as selecting the True Motion presentation mode.

1.14.1 How to reset the user settings

Menu operation

1. Select the [USER SET] box, then press the **right button** to display the [USER SET MENU].
2. Select [PILOT SETTING], then push the **ADJUST** knob.
3. Select [YES], then push the **ADJUST** knob.
4. Close the menu.

[USER SET MENU]	
1	PILOT SETTING [NO]/ YES
2	USER1 LOAD [NO]/ YES
3	USER1 SAVE [NO]/ YES
4	USER2 LOAD [NO]/ YES
5	USER2 SAVE [NO]/ YES

From the on-screen [USER SET] box

Place the cursor on the [USER SET] box, then long-press the **left button**.

Note 1: Items not shown in the above table keep their previous settings when [PILOT SETTING] is activated.

Note 2: TT tracking is continued after [PILOT SETTING] is activated.

Note 3: The radar map displays the same map as before [PILOT SETTING] is activated.

1.14.2 How to store/load user settings

1. Select the [USER SET] box, then press the **right button** to display the [USER SET MENU].
2. Select [USER1(2) LOAD] or [USER1(2) SAVE] to recall or save user settings, respectively, then push the **ADJUST** knob.
3. Select [YES], then push the **ADJUST** knob.

4. Close the menu.

When loading settings, the following points apply:

- If the newly loaded settings cannot be applied to items not listed in the table above, then these items keep their previous settings.
- TT tracking is continued after the settings are loaded.
- The radar map displays the same map as before the settings were loaded.

1.15 How to Start/Stop Transmission

The radar is ready to transmit when the message "STBY" appears. Transmission can be started using one of the following procedures:

- **Using the control unit:** Press the **STBY/TX** key.
- **Using the on-screen box:** Select the [STBY/TX] box on the screen, then press the **left button**.

How to stop antenna rotation

Antenna rotation can be stopped using one of the following procedures:

- Turn the antenna switch off.
- Turn antenna rotation off from the menu (See installation manual).

Screen freeze

The screen is not refreshed if the screen has frozen. An audio alarm is released 30 seconds after a screen freeze. The **ALERT ACK** key flashes and a contact alert signal is also released. To return the radar to normal operation, turn the radar off, then on again.

Quick start

Provided that the radar was in use and the magnetron (transmitter tube) is still warm, you can switch to transmit mode without the three minute warm-up time. If the radar was turned off by mistake or you wish to restart the radar promptly, press the **POWER** switch within ten seconds after the power is turned off.

1.16 How to Tune the Receiver

1.16.1 How to select the tuning method

1. Select the [TUNE] box at the top of the screen to change the tuning method. The tuning box is displayed as "TUNE AUTO" or "TUNE MAN", depending on the currently selected tuning method.
2. Press the **left button** to change the tuning method.

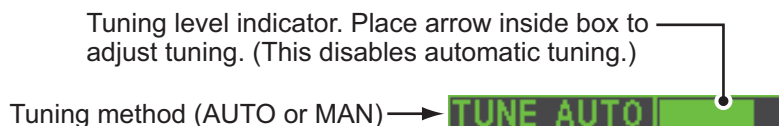

1.16.2 How to initialize tuning

Automatic tuning is initialized at installation. However, if you feel that the automatic tuning is not functioning properly, re-initialize it by following the procedure below.

1. Open the [MAIN MENU].
2. Select [ECHO], then push the **ADJUST** knob.
3. Select [TUNE INITIALIZE], then push the **ADJUST** knob.
The indication "TUNE INITIALIZE" appears in the [ALERT] box during the initialization.
4. Close the menu.

1.16.3 How to tune the receiver manually

1. Select the 48-mile range from the [RANGE] box. Press the **left button** to lower the range; the **right button** to raise the range.
2. Select manual tuning following the procedure in subsection 1.16.1.
3. Place the arrow on the tuning bar area in the [TUNE] box.
4. Rotate the **ADJUST** knob to adjust tuning. The best tuning point is where the bar graph swings maximum. The tuning control position is indicated with a triangle, displayed inside the tuning bar.



Tuning control position. ——— ↑
Place cursor inside the box, then rotate the **ADJUST** knob to adjust the tuning.

1.17 How to Select a Pulselength

The pulselength in use appears at the upper-left position of the screen using the indications shown in the table below.

FAR-1518/FAR-1528 (PULSE) indication	FAR-1513/FAR-1523 (PULSE) indication
S1 (short pulse 1)	S (short pulse)
S2 (short pulse 2)	M (medium pulse)
M1 (medium pulse 1)	L (long pulse)
M2 (medium pulse 2)	
M3 (medium pulse 3)	
L (long pulse)	

Appropriate pulselengths are preset to individual range scales and function keys. If you are not satisfied with the current pulselength settings, you can change them as shown in the procedure below.

1.17.1 How to change the pulselength

The pulselength can be changed using the procedure below.

1. Place the cursor in the [PULSE] box at the top left corner of the screen.
2. Press the **left button**, **right button** or rotate the **ADJUST** knob to cycle through pulselengths. The order in which the pulselengths are cycled is shown in the table below.

Method	Cycle order
Left button	Decreases the pulselength.
Right button	Increases the pulselength.
ADJUST knob (clockwise)	Increases the pulselength.
ADJUST knob (counter-clockwise)	Decreases the pulselength.

Note: Available pulselengths are restricted depending on the range. See the table below for details.

FAR-1518/FAR-1528		FAR-1513/FAR-1523	
Range	(PULSE) indication	Range	(PULSE) indication
0.125NM, 0.25NM, 0.5NM	S1, S2	1.5 NM	S, M
0.75 NM, 1.5 NM	S1, S2, M1, M2	3 NM	M, L
3 NM	S1, S2, M1, M2, M3		
6 NM	S2, M1, M2, M3, L		
12 NM, 24 NM	M1, M2, M3, L		

1.18 How to Adjust Sensitivity

The gain control adjusts the sensitivity of the receiver.

The proper setting is such that the background noise is just visible on the screen. If you set up for too little sensitivity, weak echoes may be missed. On the other hand excessive sensitivity yields too much background noise; strong targets may be missed because of the poor contrast between desired echoes and the background noise on the display.

To adjust receiver sensitivity, adjust the gain control so background noise is just visible on the screen.

How to adjust the GAIN from the control unit (RCU-028)

Rotate the **GAIN** knob (F3). Rotate anticlockwise to decrease the gain, or clockwise to increase the gain.

How to adjust the GAIN from the on-screen box

1. Place the cursor in the [GAIN] box at the top of the screen.



2. Rotate the **ADJUST** knob anticlockwise to decrease the gain, or clockwise to increase the gain. The setting range is [0] to [100].

1.19 How to Reduce Sea Clutter

Echoes from waves cover the central part of the display with random signals known as sea clutter. The higher the waves, and the higher the antenna above the water, the further the clutter extends. When sea clutter masks the picture, reduce it with the A/C SEA control, either manually or automatically.

Note 1: When both sea clutter and rain clutter are reduced, the sensitivity is decreased more than when only one is changed. For that reason adjust them carefully.

Note 2: The echo average (see "Echo Averaging" on page 1-24) is useful for reducing reflections from the sea surface. However, high-speed targets are harder to detect than stationary ones when the echo average is active.

1.19.1 How to select the method of clutter adjustment

1. Place the cursor in the [SEA AUTO] or [SEA MAN] (whichever is shown) at the top of the display.



2. Press the **left button** to display [SEA AUTO] or [SEA MAN] as appropriate.

1.19.2 How to fine-tune sea clutter reduction

Auto A/C SEA allows for fine tuning of the A/C SEA circuit, within ± 20 dB. Accordingly, with the bar reading set to 50, gain is not lowered to minimum as with manual A/C SEA on close-in ranges. Further, the auto A/C SEA level is low because the average value of the original input echo is low in areas where there are no sea surface reflections. For example, when the ship is alongside a quay and the radar picture shows echoes from both land and sea, you can observe the size of the echoes because the STC curve changes with the size of the echoes.

Note: The auto A/C function can erase weak target echoes. Adjust the control carefully, watching the display.

How to fine-tune sea clutter reduction from the control unit (RCU-028)

Rotate the **AC/SEA** knob (F2). Rotate anticlockwise to decrease the AC/SEA, or clockwise to increase the A/C SEA.

How to fine-tune sea clutter reduction from the on-screen box

1. Select [SEA AUTO], following the procedure in subsection 1.19.1.
2. Place the arrow on level indicator inside the A/C SEA box at the top of the display.
3. While observing the A/C SEA level indicator, rotate the **ADJUST** knob clockwise to increase the A/C SEA or counter-clockwise to decrease it. The setting range is [-50] to [50].

1.19.3 How to manually reduce sea clutter

The A/C SEA control reduces the amplification of echoes at short ranges (where clutter is the greatest) and progressively increases amplification as the range increases, so amplification will be normal at those ranges where there is no sea clutter.

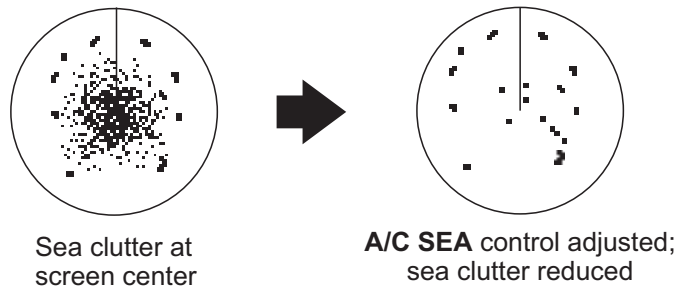

The proper setting of the A/C SEA should be such that the clutter is broken up into small dots, and small targets become distinguishable. If the setting is set too low, targets will be hidden in the clutter, while if the setting is too high, both sea clutter and targets will disappear from the display. In most cases adjust the control until clutter has disappeared to leeward, but a little is still visible windward. Be careful not to remove all sea clutter, because you may erase weak echoes. Further, the possibility of losing weak echoes is greater when you use both A/C SEA and A/C RAIN to reduce clutter.

How to reduce sea clutter manually from the control unit (RCU-028)

Rotate the **AC/SEA** knob (F2). Rotate anticlockwise to decrease the AC/SEA, or clockwise to increase the A/C SEA.

How to reduce sea clutter manually from the on-screen box

1. Select [SEA MAN], following the procedure in subsection 1.19.1.
2. Place the arrow in the A/C SEA level indicator at the top of the display.
3. While observing the A/C SEA level indicator, rotate the **ADJUST** knob clockwise to increase the A/C SEA or counter-clockwise to decrease it. The setting range is [0] to [100].

1.20 How to Reduce Rain Clutter

Use the AUTO RAIN and A/C RAIN to reduced rain clutter. AUTO RAIN reduces rain clutter in the picture and A/C RAIN reduces clutter picked up by the antenna.

Note 1: When both sea clutter and rain clutter are reduced, the sensitivity is decreased more than when only one is changed. For that reason adjust them carefully.

Note 2: The echo average (see "Echo Averaging" on page 1-24) is useful for reducing reflections from the sea surface. However, high-speed targets are harder to detect than stationary ones when the echo average is active.

1.20.1 How to select the method of rain clutter reduction

Select the [RAIN] indication at the top-right of the screen, then press the **left button** to toggle [RAIN AUTO] (automatic reduction) and [RAIN MAN] (manual reduction).

Left-click inside the box to change the A/C RAIN adjustment method (RAIN AUTO or RAIN MAN)



1.20.2 How to manually reduce rain clutter

The vertical beam width of the antenna is designed to see surface targets even when the ship is rolling. However, by this design the unit will also detect rain clutter (rain, snow, or hail) in the same manner as normal targets.

The A/C RAIN control adjusts the receiver sensitivity as the A/C SEA control does but rather in a longer time period (longer range). The higher the setting the greater the anti-clutter effect. When echoes from precipitation mask solid targets, adjust the A/C RAIN control to split up these unwanted echoes into a speckled pattern, making recognition of solid targets easier. Be careful remove all rain clutter, because you can erase weak echoes. Further, the possibility of losing weak echoes is greater when you use both A/C RAIN and A/C SEA to reduce clutter.

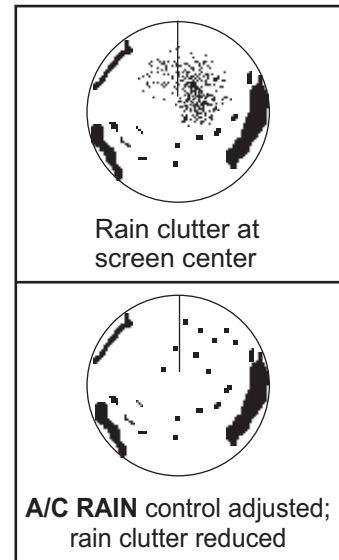

How to fine-tune sea clutter reduction from the control unit (RCU-028)

Rotate the **AC/RAIN** knob (F1). Rotate anticlockwise to decrease the AC/SEA, or clockwise to increase the A/C SEA.

How to fine-tune sea clutter reduction from the on-screen box

1. Select the [RAIN] indication at the top-right of the screen, then press the **left button** to select [RAIN MAN].



2. While observing the A/C RAIN level indicator, rotate the **ADJUST** knob clockwise to increase the A/C SEA or counter-clockwise to decrease it. 100 levels (0-100) are available.

Note: The detection range is reduced when the RAIN is used to show targets in rain. Generally, the amount of rain, TX pulse length and TX frequency are factors in determining how the detection range is affected. The figure below illustrates this.

How to interpret the graph

Using the graph below as an example, a radar target originally detected on the 8 NM range can only be detected in rain at the ranges shown below:

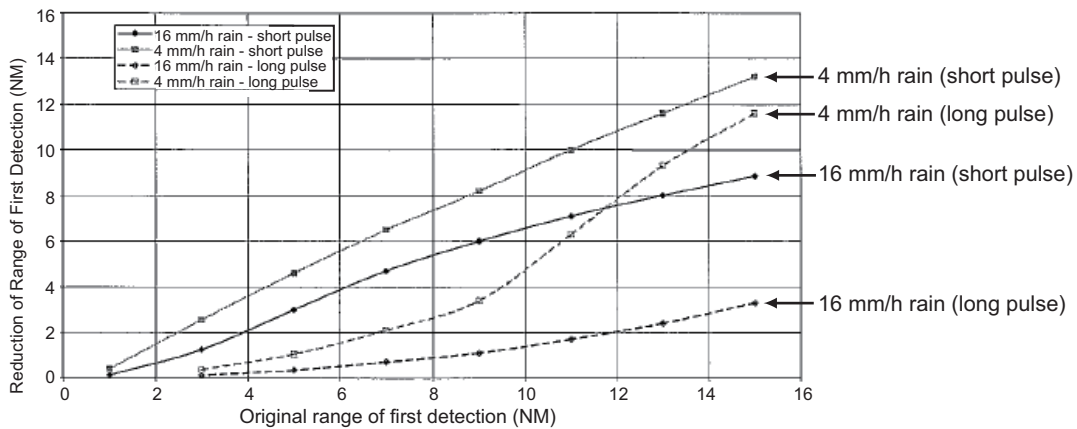

Reduction of rain to first detection due to rain at X-band

The author thanks the International Electrotechnical Commission (IEC) for permission to reproduce information from its International Standard IEC 62388 ed.1.0 (2007). All such extracts are copyright of IEC, Geneva, Switzerland. All rights reserved. Further information on the IEC is available from www.iec.ch. IEC has no responsibility for the placement and context in which the extracts and contents are reproduced by the author, or is IC in any way responsible for the other content or accuracy therein.

Accordingly, the short pulse may be preferable in rain on ranges less than 10 NM.

1.21 Interference Rejector

Mutual radar interference can occur in the vicinity of another shipborne radar operating in the same frequency band. It is seen on the screen as a number of bright spikes either in irregular patterns or in the form of usually curved spoke-like dotted lines extending from the center to the edge of the picture. Activating the interference rejector circuit can reduce this type of interference. The interference rejector is a kind of signal correlation circuit. It compares the received signals over successive transmissions and reduces randomly occurring signals. There are three levels of interference rejection depending on the number of transmissions that are correlated.

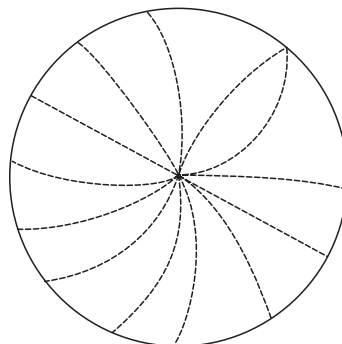

Example of interference

To adjust the interference rejector, select the [IR] box at the left side of the screen, then press the **left button** to cycle through the rejection levels. The available settings, in cyclic order, are: [OFF] → [1] → [2] → [3] → [OFF]...

Level [3] provides the highest level of rejection.

1.22 Echo Stretch

The echo stretch feature enlarges targets in the range and bearing directions to make them easier to see, and it is available on any range. There are three types of echo stretch, 1, 2 and 3, and the higher the number the greater the amount of stretch.

Note: The echo stretch magnifies not only small target pips but also returns (clutter) from sea surface, rain and radar interference. For this reason, make sure these types of interference have been sufficiently reduced before activating the echo stretch.

To set echo stretch, select the [ES] box at the left side of the screen, then press the **left button** to cycle through the settings.

The cyclic order is [OFF] → [1] → [2] → [3] → [OFF]...

1.23 Echo Averaging

The echo averaging feature effectively reduces sea clutter. Echoes received from stable targets such as ships appear on the screen at almost the same position every rotation of the antenna. On the other hand, unstable echoes such as sea clutter appear at random positions.

To distinguish real target echoes from sea clutter, echoes are averaged over successive picture frames. If an echo is solid and stable over successive frames, it is presented in its normal intensity. Sea clutter is averaged over successive scans and its brilliance reduced, making it easier to discriminate real targets from sea clutter.

Echo averaging uses scan-to-scan signal correlation technique based on the true motion over the ground of each target. Thus, small stationary targets such as buoys will be shown while reducing random echoes such as sea clutter. True echo averaging is not however effective for picking up small targets running at high speeds over the ground.

Note 1: With echo average active it is harder to detect high-speed targets than stationary ones.

Note 2: Do not use the echo averaging function under heavy pitching and rolling; loss of targets can result.

Note 3: Echo averaging requires heading, position and speed data.

Before using the echo averaging function, reduce sea clutter with the A/C SEA control. Leave a little sea clutter on the screen so as not to erase weak targets. Then, do as follows:

Select the [EAV] box at the left side of the screen, then press the **left button** to select the desired level of echo averaging.

- [OFF] : Echo averaging is not enabled
- [1], [2] : Detects targets hidden in sea clutter. [2] is more effective than [1] in detecting targets hidden in strong sea clutter. However, [1] is more effective than [2] in displaying high-speed targets. Select the setting best suited to current conditions. For effective monitoring of high-speed craft, you should use [2] together with Wiper.
- [3] : Stably displays unstable targets; distinguishes high-speed craft from sea clutter.

1.24 Automatic Clutter Elimination (ACE) Function

This radar has the Automatic Clutter Elimination (ACE) function. This function detects sea and rain clutter from received echoes' range and bearing trend and automatically reduces sea and rain clutter according to the Automatic Clutter Elimination (ACE) threshold setting.

Note: Use this function with caution. Weak target echoes may disappear from the screen.

1.24.1 How to turn the Automatic Clutter Elimination (ACE) function on/off

Select the [ACE] box at the top left of the operational display area, then press the **left button** to switch the [ACE] function [ON] or [OFF].

When [ACE] is activated, the [SEA] box and [RAIN] box are gray colored and cannot be adjusted. The [GAIN] box changes to [GAIN ACE], as shown in the figure below.

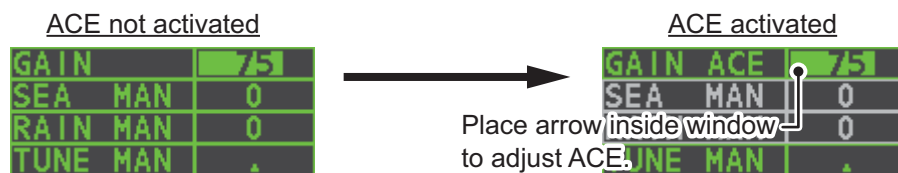

Note: When [PERFORMANCE MON] (see section 1.47) or [SART] (see section 2.3) is [ON], [ACE] is disabled and cannot be activated.

1.24.2 How to adjust the gain in Automatic Clutter Elimination (ACE) mode

Rotate the **F3** knob to adjust the sensitivity. (For default function key settings only.)

ACE can also be adjusted by placing the cursor inside the [GAIN ACE] level, then rotating the **ADJUST** knob.

1.24.3 How to get high sensitivity

When Automatic Clutter Elimination (ACE) function is [ON], the high sensitivity mode operates while pressing the **GAIN** control. You can select the level for the high sensitivity mode as follows:

1. Open the [MAIN MENU].
2. Select [ECHO], then push the **ADJUST knob**.
3. Select [0 ACE] (For non-IMO radars) or [9 ACE] (IMO radars), then push the **ADJUST knob**.
4. Select [SIGNAL ENHANCEMENT], then push the **ADJUST knob**.
5. Select the level from [1], [2] or [3].
6. Close the menu.

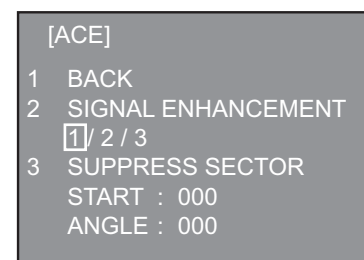

1.24.4 How to suppress false echoes

The echo signals can appear on the screen at positions where there is no target or disappear when there are targets (see section 2.2). You can suppress the false echoes.

1. Open the [MAIN MENU].
2. Select [ECHO], then push the **ADJUST** knob.
3. Select [0 ACE] (For non-IMO radars) or [9 ACE] (IMO radars), then push the **ADJUST knob**.
4. Select [SUPPRESS SECTOR], then push the **ADJUST knob**.
5. Rotate the **ADJUST** knob to set the starting angle for sector to be suppressed, then push the **ADJUST knob**.
6. Rotate the **ADJUST** knob to set the angle range of the sector to be suppressed, then push the **ADJUST knob**.
7. Close the menu.

1.25 Noise Rejector

White noise can show itself on the screen as random “speckles” spread over the entire radar image. This equipment reduces the white noise, then improves the on-screen S/ N ratio by processing the weighted moving average filter for the received echoes in the range direction.

Note: Use this function with caution. Weak target echoes may disappear from the screen or the range resolution may worsen.

You can remove this noise by placing the cursor inside the [NR] box at the left side of the screen, then press the **left button** to select [ON] or [OFF].

1.26 Wiper

The wiper feature automatically reduces the brilliance of weak signals (noise, sea clutter, rain clutter, etc.) and unwanted signals such as radar interference to clear the picture of unwanted echoes. Its effect depends on the wiper setting used and whether each averaging is turned on or off, as described below.

	Wiper setting 1	Wiper setting 2
Echo averaging OFF	Condition A	Condition A
Echo averaging ON(1/2/3)	Condition A	Condition B

Condition A: The brilliance of unwanted weak echoes, such as noise, sea clutter and rain clutter, is reduced to clear up the picture. The difference between wiper setting [1] and [2] is that brilliance is lowered more slowly in [2].

Condition B: Echo averaging is automatically activated when the wiper feature is turned on, allowing you to instantly see how the picture is affected with echo averaging turned off and turned on.

To activate the wiper feature, do the following:

1. Open the [MAIN MENU].

2. Select [ECHO], then push the **ADJUST** knob.
3. Select [WIPER], then push the **ADJUST** knob.
4. Rotate the **ADJUST** knob to cycle through and select the desired setting. The options, in order, are: OFF → 1 → 2 → OFF...
With the desired setting selected, push the **ADJUST** knob.
5. Close the menu.

1.27 How to Preset Controls for a Specific Navigation Purpose

Every time your navigating environment or task changes, you must adjust the radar, which can be a nuisance in a busy situation. Instead of changing radar settings case by case, it is possible to assign the function keys to provide optimum settings for often-encountered situations.

The radar's internal computer offers several picture preset options to be assigned to each function key for your specific navigating requirements. For instance, one of the presets is [HEAVY RAIN], and is designed to be used in heavy rain.

Two user-programmable presets are also provided (labeled as [CUSTOM1], [CUSTOM2]), so that you can have the radar automatically set to those conditions which are not covered by the provided setup options.

Below are the preset options provided with this radar.

Label	Description	Label	Description
[CUSTOM1]	User-defined custom settings.	[CUSTOM2]	User-defined custom settings.
[NEAR]	Optimum setting for short range detection using a range scale of 3 NM or less on calm seas.	[FAR]	Optimum setting for long range detection, on a range scale of 6 NM or larger.
[HEAVY RAIN]	Optimum setting for rough weather or heavy rain.	[SHIP]	Optimum setting for detecting other vessels.

Each picture option defines a combination of several radar settings for achieving optimum setup for a particular navigating situation. These include interference rejector, echo stretch, echo average, noise rejector, automatic anti-sea and anti-rain clutters, video contrast, pulse length and sea and radar conditions.

Changing these features from the [CUSTOMIZE ECHO] menu changes the original function key settings. To restore the original settings for a particular customize option, it is necessary to select the default setting. For this reason, we recommended that you use the user-programmable presets ([CUSTOM1] or [CUSTOM2]) when frequent adjustment of the radar image is necessary.

The default settings for the custom presets are listed in a table on the following page.

1. OPERATIONAL OVERVIEW

Default settings

		CUSTOM1	CUSTOM2	NEAR	FAR	HEAVY RAIN	SHIP
GAIN	MODE	MAN	MAN	MAN	MAN	MAN	MAN
	LEVEL	85	85	85	85	80	85
SEA	MODE	MAN	AUTO	MAN	MAN	MAN	MAN
	LEVEL	30	0	30	30	40	30
RAIN	MODE	MAN	MAN	MAN	MAN	MAN	MAN
	LEVEL	0	0	0	0	40	25
INT REJECT		1	1	1	1	2	2
ECHO STRETCH		1	2	OFF	3	OFF	2
ECHO AVERAGE		1	2	1	2	2	1
NOISE REJECT		OFF	ON	OFF	OFF	ON	ON
VIDEO CONTRAST TYPE		2-B	2-B	2-B	3-B	1-B	2-B
ACE		OFF	ON	OFF	OFF	ON	ON
ACE GAIN		80	80	80	80	80	80
PULSE (FAR-1518/1528)	0.5NM	S1	S1	S1	S1	S1	S1
	0.75NM	S1	S1	S1	S2	S1	S2
	1.5NM	S1	S2	S1	M1	S1	M1
	3NM	S2	M1	S2	M2	S2	M2
	6NM	M2	M2	M1	M3	M1	M3
	12NM	M3	M3	M2	L	M2	L
	24NM	L	L	M3	L	M3	L
PULSE (FAR-1513/1523)	1.5NM	S	S	S	M	S	M
	3NM	M	M	M	M	M	M
CONDITION	NEAR STC CURVE	3	3	3	3	3	3
	STC ANT HEIGHT (m)	Set at installation.					
	LOW LEVEL ECHO	0	0	0	0	0	0

1.27.1 How to select a customized echo

Left-click [CUSTOMIZE ECHO] box at the top left of the screen to cycle through the options and select a customized echo option. The available options, in cyclic order, are: [CUSTOM1] → [CUSTOM2] → [NEAR] → [FAR] → [HEAVY RAIN] → [SHIP].

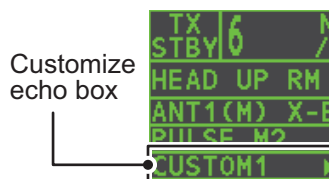

1.27.2 How to edit a customized echo

1. Select a customize echo option to edit (see subsection 1.27.1).
2. Select the [CUSTOMIZE ECHO] box, then press the right button to display the [CUSTOMIZE ECHO] menu.
3. Set the items below referring to the sections shown.

• [INT REJECT] : section 1.21	• [HATCHING] : section 1.37
• [ECHO STRETCH] : section 1.22	• [NOISE REJECT] : section 1.25
• [ECHO AVERAGE] : section 1.23	• [PULSE] : section 1.17
• [TARGET ANALYZER] : section 1.37	• [ACE] : section 1.24
4. Select [VIDEO CONTRAST TYPE], then push the **ADJUST knob**.
5. Select [1], [2], [3] or [4] (Dynamic Range) or [A], [B], [C] (Curve) as appropriate then press the **left button**. Refer to the description and illustration below.

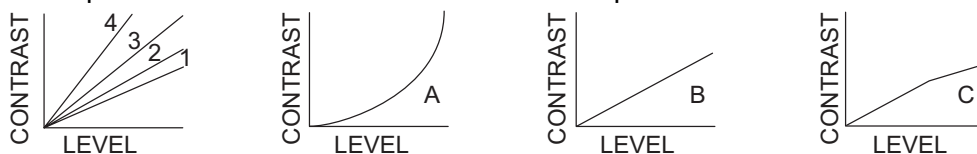

1-4: Control dynamic range. 1 provides the widest dynamic range; 4 is the narrowest dynamic range.

A: Low level echo brilliance is reduced and noise and clutter are also reduced.

B: Low and high level echoes are displayed evenly.

C: High level echoes' outer edge has gradation to indicate the echo level, with the higher level echo at the core.

6. Select [9 CONDITION], then push the **ADJUST knob**.
7. Select [2 NEAR STC CURVE], then push the **ADJUST knob**.
8. Select the appropriate setting for the current sea conditions, then push the **ADJUST knob**. The available settings are: [2], [2.5], [3], [3.5], [4.2]. A higher setting is recommended for rough weather.
9. Select [1 STC ANT HEIGHT], then push the **ADJUST knob**.
10. Select the radar antenna height (above the waterline), then push the **ADJUST knob**.
11. If necessary, select [2 LOW LEVEL ECHO] to reject low level echoes. The setting range is [0] to [8]. The higher the figure, the stronger the low level echo that is erased.
12. To save custom settings, select [SAVE] from [0 DEFAULT], then push the **ADJUST knob**.

1.27.3 How to restore a user customized echo to the saved settings

If you get lost in operation while changing the settings for a user customized echo, you can easily restore the settings for that user customized echo saved at subsection 1.27.2.

1. Select the [CUSTOMIZE ECHO] box, then press the right button to display the [CUSTOMIZE ECHO] menu.
2. Select [0 DEFAULT], then push the **ADJUST knob**.
3. Select [USER], then push the **ADJUST knob**.

1.27.4 How to restore a user customized echo to the factory default settings

You can restore customized echo options to their factory default (see the table on page 1-28).

1. Select the [CUSTOMIZE ECHO] box, then press the right button to display the [CUSTOMIZE ECHO] menu.
2. Select [0 DEFAULT], then push the **ADJUST knob**.
3. Select [FACTORY], then push the **ADJUST knob**.

1.28 How to Reject Second-trace Echoes

In certain situations, echoes from very distance targets can appear as false echoes (second-trace echoes) on the screen. This occurs when the return echo is received one transmission cycle later, or after the next radar pulse has been transmitted.

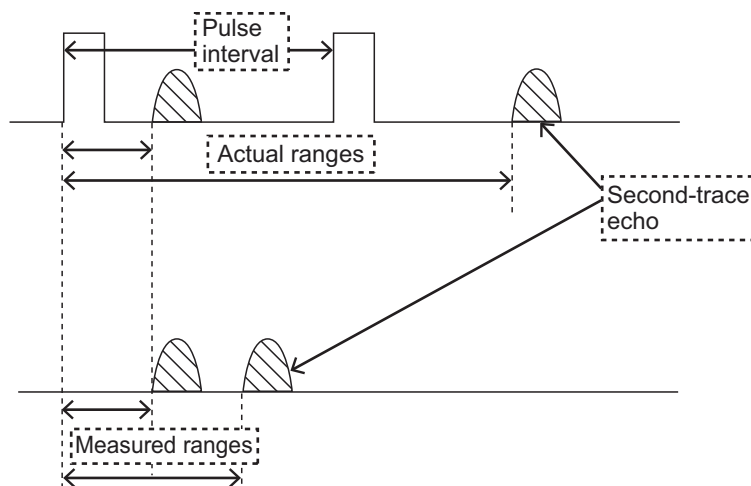

This equipment lengthens the pulse repetition period to reject false echoes.

Note: This function decreases the number of echo hits. Use this function carefully so that the possibility of detecting small targets and high-speed craft does not lessen.

To reject second trace echoes, do the following:

1. Open the [MAIN MENU].
2. Select [ECHO], then push the **ADJUST knob**.
3. Select [2ND ECHO REJ], then push the **ADJUST knob**.
4. Select [ON], then push the **ADJUST knob**. Select [OFF] to disable rejection.
5. Close the menu.

1.29 Presentation Modes

This radar has the following presentation modes available:

Relative Motion (RM)

- HEAD UP : Not stabilized
- STAB HEAD UP : Head-up with compass bearing scale (True Bearing) where the bearing scale rotates with the compass reading.
- COURSE UP : Compass-stabilized relative to ship's orientation at the time of selecting COURSE UP.
- NORTH UP : Compass-stabilized with reference to North.
- STERN UP : The radar image is rotated 180°. Graphics and relative and true bearings are also rotated 180°.

True Motion (TM)

Land objects and sea are stationary. Requires compass and speed data.

1.29.1 How to select an presentation mode

Select the [PRESENTATION MODE] box at the top left corner of the screen, then press the **left button** to select a presentation mode.

HEAD UP RM *

*= Other modes:

STERN UP RM, STAB HEAD UP RM,
COURSE UP RM, NORTH UP RM, NORTH UP TM

Loss of gyrocompass signal

When the compass signal is lost, "LOST GYRO SIGNAL" appears in yellow-orange in the [ALERT] box, the presentation mode automatically becomes HEAD UP, and TT and AIS targets, map and chart are erased. Stop the alert with the [ALERT ACK] key or select the [ALERT] box, then press the **left button**. Check the GYRO data.

1.29.2 Description of presentation modes

HEAD UP mode

A display without azimuth stabilization in which the line that connects the center with the top of the display indicates your heading. Targets are shown at their measured distances and their directions relative to your heading. The short dotted line on the bearing scale is the north marker.

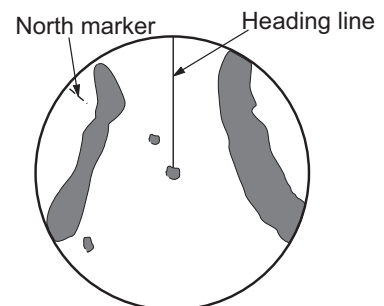

COURSE UP mode

The radar picture is stabilized and displayed with the currently selected course at the top of the screen. When you change the heading, the heading line moves with the course selected. If you select a new course, select the course up mode again to display the new course at the top of the display. Targets are shown at their measured distances and their directions relative to the set course, which is at the 0-degree position. The heading line moves according to the yawing and any course change.

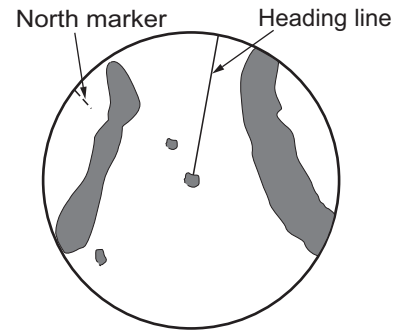

NORTH UP mode

Targets are shown at their measured distances and their true (compass) directions from your ship. North is at the top of the screen. The heading line changes its direction according to your heading.

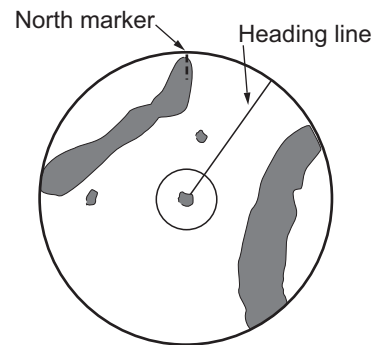

STAB HEAD UP mode

Radar echoes are shown in the same way as in the HEAD UP mode. The difference from normal HEAD UP presentation lies in the orientation of the bearing scale. The bearing scale is heading sensor stabilized. That is, it rotates in accordance with the heading sensor signal, enabling you to know own ship's heading at a glance.

This mode is available when the radar is interfaced with a gyrocompass. If the gyrocompass fails, the bearing scale returns to the state of HEAD UP mode.

True motion mode

Your ship and other objects in motion move with their true courses and speed. All fixed targets, like landmasses, appear as fixed echoes in ground stabilized TM. When your ship reaches a point that is 50% of the radius of the display, the position is reset. The ship appears at 75% radius opposite to the extension of the heading line on the display center. You can manually reset your ship symbol if you highlight the [CU/TM RESET] indication at the top of the screen, then press the **left button**.

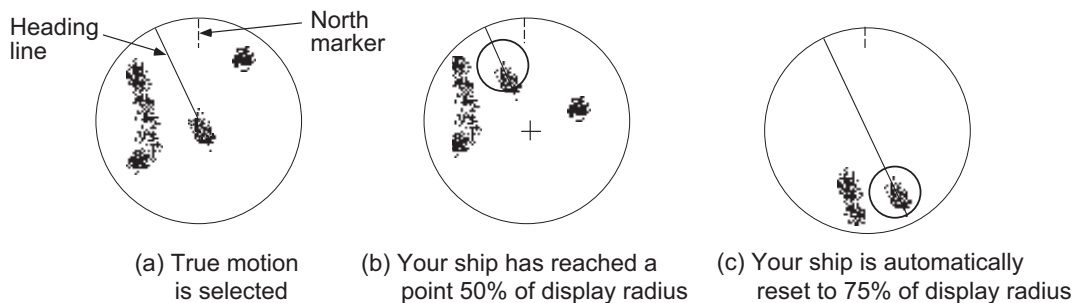

STERN UP mode

The STERN UP mode rotates the HEAD UP mode picture, relative and true bearings and display graphics 180°. This mode is useful on dual-radar tugboats when backing up; one radar shows HEAD UP and another shows STERN UP. To enable the STERN UP mode, turn on [STERN UP] on the [OPERATION] menu.

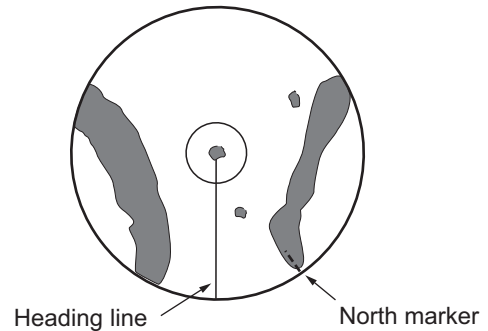

1.30 How to Select a Range Scale

The selected range scale, range ring interval and pulselength are shown at the upper left corner on the screen. When a target of interest comes closer, reduce the range scale so that it appears in 50-90% of the display radius.

1. Place the cursor in the [RANGE] box at the top left corner of the screen.

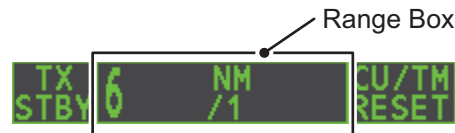

2. Press the **left button** to lower the range; the **right button** to raise the range. You can also select the range by rotating the **ADJUST knob** then pushing the **ADJUST knob** when the cursor is inside the range box.

1.31 How to Measure Range

The range to a target can be measured three ways: with the fixed range rings, with the cursor, or with the VRM.

Use the fixed range rings to get an estimate of the range to a target. The rings are the concentric solid circles on the display. The number of rings is automatically set by the current range scale. The distance between the rings is the range ring interval, and the current interval appears at the upper-left position on the screen. To measure the range to a target with the range rings, count the number of rings between the center of the display and the target. Check the range ring interval and estimate the distance of the echo from the inner edge of the nearest ring.

1.31.1 How to show/hide the range rings

1. Open the [MAIN MENU].
2. Select [NAVTOOL], then push the **ADJUST knob**.
3. Select [RANGE RING], then push the **ADJUST knob**.
4. Rotate the **ADJUST knob** to select [ON] or [OFF] as appropriate, then push the **ADJUST knob**.
5. Close the menu.

Note: The range rings can also be shown, hidden from the [CURSOR] menu (left-click the display to show), with [4 RANGE RING].

1.31.2 How to measure range with the variable range marker (VRM)

There are two VRMs, No. 1 and No. 2, which appear as dashed rings so that you can distinguish them from the fixed range rings. The two VRMs can be distinguished from each other by the different lengths of their dashes; the dashes on the No. 2 VRM are longer.

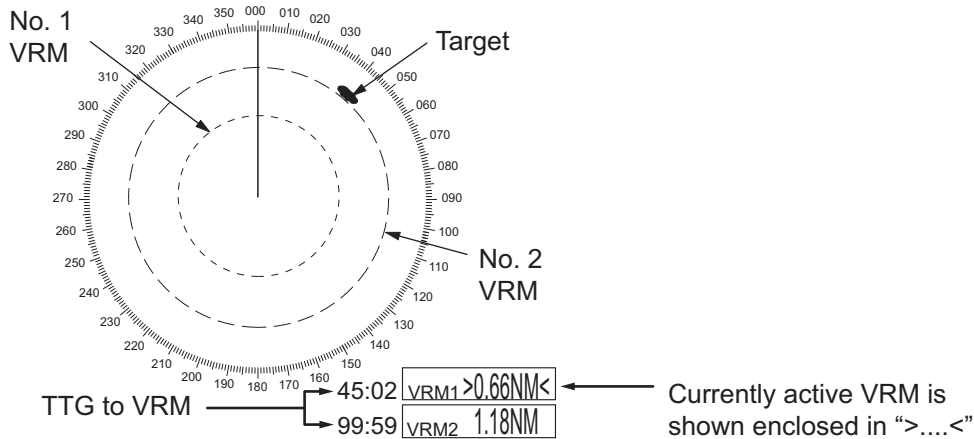

There are two methods for measuring range with the VRMs, using the **VRM** key and on-screen menu box operation.

Using the VRM key

1. Press the **VRM** key to display the VRM boxes. Press the **VRM** key again to switch between active VRMs. The currently active VRM marker is displayed as shown in the figure on the previous page.
2. Rotate the **ADJUST** knob to align the active VRM with the inner edge of the target, then read the distance at the lower right of the screen. In the on the previous page, the VRM reads "0.66NM".
Each VRM remains at the same geographical distance when you operate the **RANGE** key or the [RANGE] box. This means that the apparent radius of the VRM ring changes in proportion to the selected range scale.
3. Press and hold the **VRM** key to erase the selected VRM.

On-screen menu box operation

1. Select the appropriate VRM box.
2. The guidance box reads "VRM ON/". Press the **left button** to turn on the VRM. The guidance box now reads "VRM SET L = DELETE /".
3. Press the **left button** again and the cursor jumps to inside the operational display area. The guidance box now reads "VRM FIX / EXIT".
4. Rotate the **ADJUST** knob to set the distance for VRM.
Note: The maximum VRM distance is set by the current display range and can be set as high as twice the distance of the display range.
5. Press the **left button** to anchor the VRM and fix its readout, or press the **right button** to cancel and return the VRM to its previous location (range).
6. Press and hold the **VRM** key to erase the selected VRM.

1.31.3 How to set the VRM unit of measurement (non-IMO type only)

VRMs can be displayed in the following units of measurement:

- NM (Nautical Miles)
- SM (Statute Miles)
- KM (Kilometers)
- KYD (Kiloyards)

To change the unit of measurement, do the following:

1. Open the [MAIN MENU].
2. Select [NAVTOOL], then push the **ADJUST** knob.
3. Select [EBL•VRM], then push the **ADJUST** knob.
4. Select [VRM1] or [VRM2] as appropriate, then push the **ADJUST knob**.
5. Select the unit of measurement, then push the **ADJUST** knob.
6. Close the menu.

1.31.4 How to show TTG to VRM

TTG (Time To Go) to a selected VRM can be displayed as follows:

1. Open the [MAIN MENU].
2. Select [NAVTOOL], then push the **ADJUST** knob.
3. Select [EBL•VRM•CURSOR], then push the **ADJUST** knob.
4. Select [VRM TTG], then push the **ADJUST knob**.
5. Select [OFF], [1], [2] or [1&2] as appropriate, then push the **ADJUST** knob.
 - [OFF]: No TTG to VRM displayed.
 - [1]: TTG to VRM1 displayed.
 - [2]: TTG to VRM2 displayed.
 - [1&2]: TTG to VRM1 and VRM2 displayed.

TTG indication → 01:15
VRM1>3.682NM<

6. Close the menu.

1.32 How to Measure Bearing

The Electronic Bearing Lines (EBLs) are used to take bearings of targets. There are two EBLs, EBL1 and EBL2. Each EBL is a straight dashed line extending out from the own ship position up to the circumference of the radar picture. The two EBLs can be distinguished from each other by the different lengths of their dashes; the dashes on EBL2 are longer.

Each EBL has an EBRL (Electronic Bearing Range Line, indicated as a short line, crossing the EBL at right angles). When VRM is not displayed and only EBL is displayed, the EBRL shows the range from the EBL origin.

When VRMs are displayed with EBLs the VRM overlaps the EBRL. The value for EBRL and VRM is the same and is displayed in the VRM box at the bottom-right of the screen.

1. OPERATIONAL OVERVIEW

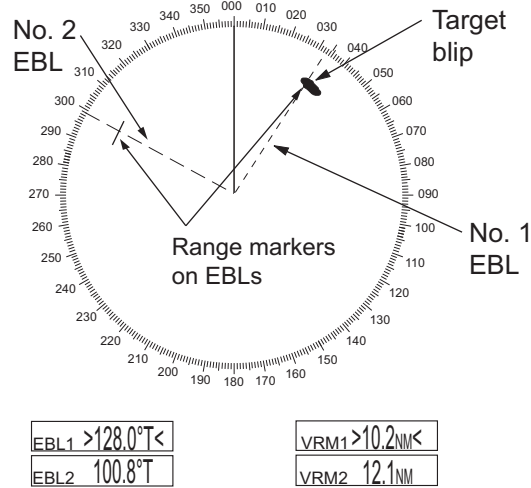

1.32.1 Methods to measure bearing

There are two methods for measuring bearing, using the **EBL** key and on-screen menu box operation.

Using the EBL key

1. Press the EBL key to display the EBL boxes. Press the key again to change between EBLs. The currently active EBL appears as shown in the figure below.

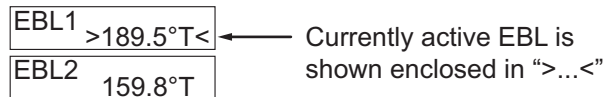

2. Rotate the **ADJUST** knob clockwise or counterclockwise until the active EBL bisects the target of interest, and read its bearing at the lower-left corner of the screen.
3. Press and hold the EBL key to erase the active EBL.

On-screen menu box operation

1. Select the appropriate EBL box.
2. The guidance box reads "EBL ON/". Press the **left button** to turn on the EBL. The guidance box now reads "EBL SET L=DELETE /".
3. Press the **left button** again and the cursor jumps to inside the operational display area. The guidance box now reads "EBL FIX L=DELETE/".
4. Rotate the **ADJUST** knob clockwise or counterclockwise until the active EBL bisects the target of interest, then push the **ADJUST** knob to anchor the EBL. Read the bearing at the lower-left corner of the screen.
5. Press and hold the EBL key to erase the active EBL.

1.32.2 True or relative bearing

The EBL readout is affixed by "R" (relative) if it is relative to own ship's heading, "T" (true) if it is referenced to the north. True or relative indication is available regardless of presentation mode.

1. Open the [MAIN MENU].
2. Select [NAVTOOL], then push the **ADJUST** knob.
3. Select [EBL•VRM], then push the **ADJUST** knob.
4. Select [EBL1] or [EBL2] as appropriate, then push the **ADJUST** knob.
5. Select the [REL] or [TRUE] as appropriate, then push the **ADJUST** knob.
6. Close the menu.

Note: The EBL and its indication change according to gyrocompass changes as follows:

Gyro heading	EBL changes
HEAD UP / relative	EBL indication and EBL marker are unchanged.
HEAD UP / true	EBL indication does not change, however the EBL marker moves accordingly
COURSE UP / relative	EBL indication does not change, however the EBL marker moves accordingly.
COURSE UP / true	EBL indication and EBL marker are unchanged.
NORTH UP / relative	EBL indication does not change, however the EBL marker moves accordingly
NORTH UP / true	EBL indication and EBL marker are unchanged.

1.33 Collision Assessment by Offset EBL

The origin of the EBL can be placed anywhere with the Touchpad to enable measurement of range and bearing between any two targets. This function is also useful for assessment of the potential risk of collision. It is possible to read CPA (Closest Point of Approach) by using a VRM as shown in (a) in the illustration below. If the EBL passes through the sweep origin (own ship) as shown in (b) in the illustration below, the target ship is on a collision course.

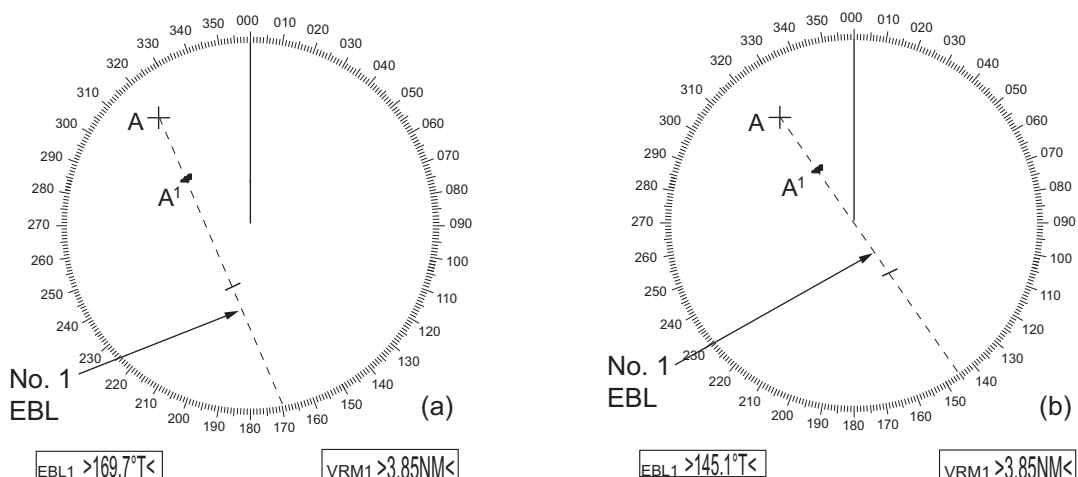

1.33.1 How to assess risk of collision using the offset EBL

There are two methods for assessing risk collision. You can use the control unit or the [CURSOR] menu.

Using the control unit (RCU-028)

Note: The [EBL OFFSET] function must be assigned to a function key (F1, F2 or F3) for this method. See section 1.9 for how to assign the function keys.

1. Press the EBL key to display or activate an EBL (EBL1 or EBL2).
2. Place the cursor on a target appearing as threatening (indicated as "A" in the figure above).
3. Press the **EBL OFFSET** function key and the origin of the active EBL shifts to the cursor position. Press the **EBL OFFSET** function key again to anchor the EBL origin.
4. After waiting for a few minutes (at least 3 minutes), operate the **ADJUST** knob until the EBL bisects the target at the new position (A¹). The EBL readout shows the target ship's course, which can be true or relative depending on the EBL bearing reference setting.

Note: If relative motion is selected, it is also possible to read CPA by using a VRM as shown in left-hand figure at the top of the next page. If the EBL passes through the sweep origin (own ship) as illustrated in the right-hand figure above, the target ship is on a collision course.

5. To return the EBL origin to the own ship's position, press the **EBL OFFSET** function key.

Using the on-screen box

1. Select the operational display area, then press the **right button**. The [CURSOR] context menu appears.
2. Select [EBL OFFSET], then press the **left button**.
3. Select the operational display area, then press the **left button**. The EBL line is attached to the cursor.
4. Place the offset EBL on the target appearing as threatening, then press the **left button**.
5. After waiting for a few minutes (at least 3 minutes), operate the EBL used in step 4 until it bisects the target at the new position (A¹). The EBL readout shows the target ship's course, which can be true or relative depending on the EBL bearing reference setting.
6. To return the EBL origin to the own ship's position, repeat steps 1 and 2, then press the **right button**.
7. Close the menu.

1.33.2 How to set the origin point reference for EBL OFFSET

The origin point of the offset EBL can be ground stabilized (geographically fixed), north stabilized (true) or referenced to own ship's heading (relative).

1. Open the [MAIN MENU].
2. Select [NAVTOOL], then push the **ADJUST knob**.
3. For IMO radars, select [EBL•VRM•CURSOR], then push the **ADJUST knob**.
For non-IMO radars, select [EBL•VRM], then push the **ADJUST knob**.
4. Select [EBL OFFSET BASE], then push the **ADJUST knob**.
5. Rotate the **ADJUST knob** to select [STAB GND], [STAB HDG] or [STAB NORTH] as appropriate, then push the **ADJUST knob**.
 - [STAB GND]: Reference to latitude and longitude. Origin position is always fixed regardless of your ship's movement.
 - [STAB HDG]: Reference to heading. The relationship between origin position and own position is kept always.
 - [STAB NORTH]: Reference to North. The origin position changes with North position.
6. Close the menu.

1.34 How to Measure Range and Bearing Between Two Targets

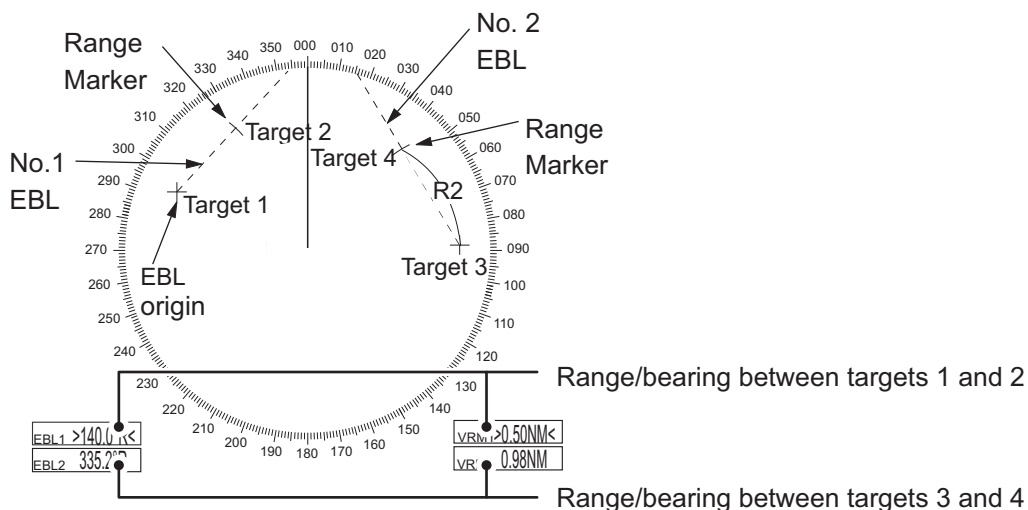

How to measure range and bearing from the [CURSOR] menu

This procedure uses EBL1 and VRM1 as an example and is written on the premise that neither of the EBLs or VRMs is active.

1. Place the cursor on the EBL1 box, then press the **left button**. EBL1 is now active.
2. Place the cursor inside the operational display area, then press the **right button**. The [CURSOR] context menu appears.
3. Select [EBL OFFSET], then push the **ADJUST knob**. The cursor is displayed with a red surround. The [EBL OFFSET] mode is now active.

1. OPERATIONAL OVERVIEW

4. With the cursor in the operational display area, press the **ADJUST** knob. EBL1 moves to the cursor location.
5. Place the offset EBL on the target of interest (Target 1), then push the **ADJUST** knob.
6. Press the **right button** to deactivate the [EBL OFFSET] mode. The red surround on the cursor disappears.
7. Place the cursor on the EBL1 box, then rotate the **ADJUST** knob until EBL1 intersects the secondary target (Target 2 in the example figure).
8. Place the cursor on the VRM1 box, then rotate the **ADJUST** knob until the range marker on EBL1 aligns with Target 2. The readouts for EBL1 and VRM1, at the bottom of the screen, indicate the bearing and range between the Target 1 and Target 2.
9. You can repeat the same procedure on third and fourth targets (shown as "Target 3" and "Target 4" in the above example) by using EBL2 and VRM2.

Bearing is shown relative to own ship with suffix "R" or as a true bearing with suffix "T" depending on EBL relative/true settings in the [EBL•VRM] menu.

How to measure range and bearing from the control unit

Range and bearing can be measure using the function keys. This requires at one of the function keys (**F1**, **F2** or **F3**) to be assigned the [EBL OFFSET] function.

This procedure uses [EBL1] and [VRM1] as an example, with **F1** assigned as the [EBL OFFSET] function key.

1. Press the **EBL** key to activate EBL1.
2. Place the cursor inside the operational display area, then press the **F1** knob. EBL1 moves to the cursor.
3. Place the cursor (EBL1 moves with the cursor) on a target of interest. (Shown as "Target 1" in the above example), then press the **ADJUST** knob.
4. Press the **right button**.
5. Place the cursor on the [EBL1] box.
6. Rotate the **ADJUST** knob to move the EBL until it passes through another target of interest. (Shown as "Target 2" in the above example).
7. Press the VRM key, to activate VRM1.
8. Rotate the **ADJUST** knob until the range marker on the EBL is on the inside edge of Target 2. The readouts for EBL1 and VRM1, at the bottom of the screen, indicate the bearing and range between the Target 1 and Target 2.
9. You can repeat the same procedure on third and fourth targets (shown as "Target 3" and "Target 4" in the above example) by using the No. 2 EBL and the No. 2 VRM.

Bearing is shown relative to own ship with suffix "R" or as a true bearing with suffix "T" depending on EBL relative/true settings in the [EBL•VRM] menu.

How to reset the EBL origin to the center of the screen

1. Place the cursor on the EBL1 box, then press the **left button**. EBL1 is now active.
2. Place the cursor inside the operational display area, then press the **right button**. The [CURSOR] context menu appears.
3. Select [EBL OFFSET], then push the **ADJUST knob**. The cursor is displayed with a red surround.
4. Press the **left button**. The EBL returns to the center of the display.
5. Press the **right button** to deactivate the [EBL OFFSET] mode. The red surround on the cursor disappears.

How to link EBL and VRM OFFSET

You can link the EBL and VRM offset to show the VRM range ring with one target as the center-point. This may be helpful if the range marker on the EBL is difficult to see.

1. Open the [MAIN MENU].
2. Select NAVTOOL, then push the **ADJUST knob**.
3. Select [EBL•VRM•CURSOR], then push the **ADJUST knob**.
4. Select [VRM OFFSET], then push the **ADJUST knob**.
5. Select [LINK EBL], then push the **ADJUST knob**. The offset EBL is now displayed with the linked VRM range ring, as indicated in the figure below.

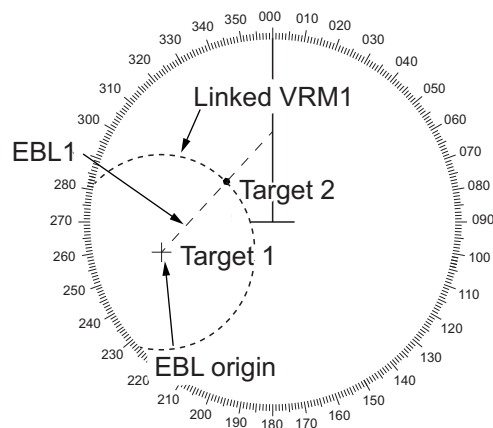

1.35 How to Off-Center the Display

Own ship position, or sweep origin, can be displaced to expand the view field without switching to a larger range scale. The sweep origin can be off-centered to the cursor position, but not more than 75% of the range in use; if the cursor is set beyond 75% of the range scale, the sweep origin will be off-centered to the point of 75% of the limit.

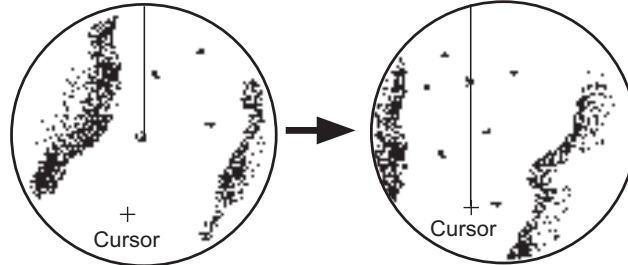

Put cursor where desired and do appropriate off-center procedure.

Off-centered display

This feature is not available on the 96 nm range or in the true motion mode.

If the conning position is outside the effective radar display, some parts of the bearing scale are not shown. For details, see section 1.48.

How to off-center the display from the control unit

1. Place the cursor at the position where you wish to move the sweep origin.
2. Press the **OFF CENTER** key. The sweep origin is now off-centered at the cursor position.
3. To cancel off-centering, press the **OFF CENTER** key again.

How to off-center the display from the on-screen menu

1. Place the cursor at the position where you wish to move the sweep origin.
2. Press the **right button** to show the [CURSOR] menu.
3. Select [OFF CENTER], then push the **ADJUST** knob.
4. To cancel [OFF CENTER], press the **right button**.

Note: When the conditions shown below are met, off-center cannot be canceled. This is because the radar antenna position is located at a position greater than 75% of the effective radar display.

- Own ship marker is large.
- The distance between antenna position and conning position is large.
- Short-distance display range.

To cancel the off-center, select a larger range, then cancel the off-center.

1.36 Target Trails

The trails of the radar echoes of targets can be displayed in the form of synthetic afterglow. Target trails are shown either relative or true and can be sea or ground stabilized. True motion trails require a compass signal, and position and speed data. When the range is changed, trails are continued for targets which were already displayed in the previous range. Newly detected targets have no trail when first detected.

1.36.1 True or relative trails

You can display echo trails in true or relative motion. Relative trails show relative movements between targets and own ship. True motion trails present true target movements in accordance with their over-the-ground speeds and courses.

Note 1: The [TRAIL MODE] box is shown in yellow under following conditions:

- [TRAIL MODE] is set to [TRUE] and presentation mode is set to [HEAD UP RM].
- [TRAIL MODE] is set to [TRUE] and presentation mode is set to [STERN UP].

The reference for the past position displays for AIS and TT is also switched whenever trail reference is switched.

Note 2: The [TRAIL MODE] box is shown in cyan under the following conditions:

- [TRAIL MODE] is set to [TRUE] and presentation mode is set to [STAB HEAD UP RM].
 - [TRAIL MODE] is set to [TRUE] and presentation mode is set to [COURSE UP RM].
 - [TRAIL MODE] is set to [TRUE] and presentation mode is set to [NORTH UP RM].
1. Select the [TRAIL] box at the bottom-right of the screen, then press the **right button**. The [TRAIL MENU] appears.
 2. Select [TRAIL MODE], then push the **ADJUST** knob.
 3. Referring to the figure on the right, select the appropriate trail mode, then push the **ADJUST** knob.
 4. Close the menu.



1.36.2 Trail time

Trail time is the interval at which the trail is plotted on-screen. You can change the trail time as follows:

Using the control unit (RCU-028)

1. Place the cursor on the trail time setting inside the [TRAIL] box at the bottom-right corner of the screen, then press the **left button**. You can also press the **TGT TRAIL** key to cycle through and select the desired setting.

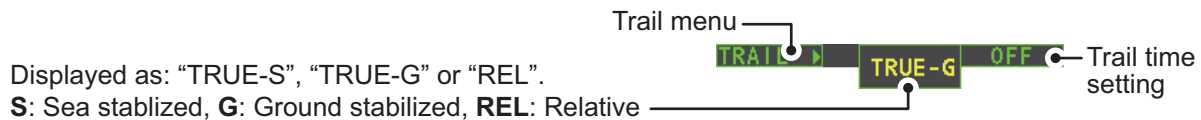

The options, in order, are: [OFF] → [15 sec] → [30 sec] → [1 min] → [3 min] → [6 min] → [15 min] → [30 min] → [CONT] → [OFF]...

Using the on-screen box

1. Place the cursor on the trail time setting inside the TRAIL box, at the bottom-right of the screen.
2. Rotate the **ADJUST** knob to change the trail time. The time is changed in 30 second increments

Note: When using the scrollwheel on the RCU-030 to change the trail time, the time is changed in 30 second increments also.

Note 1: The timer displays the elapsed time of the selected trail. Use caution when using this feature, as the displayed time is not the overall trail time. Also, when the trail timer is displayed, the trail accuracy of other ship's echoes may be lowered. When the trail time reaches the preset interval, the timer disappears.

Note 2: The [CONT] option sets the trail time plotting as continuous. When the plotting time reaches 29:59, the timer is hidden. The timer reappears when [TRAIL ALL CLEAR] is selected, or when the range is changed.

1.36.3 Trail gradation

The trail afterglow can be displayed in a single tone or with gradual shading.

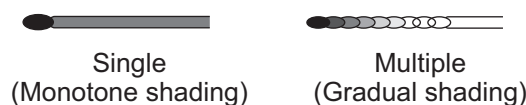

1. Select the [TRAIL] box at the bottom-right corner of the screen, then press the **right button** to display the [TRAIL MENU].
2. Select [TRAIL GRAD], then push the **ADJUST** knob.
3. Select [Single] or [Multi] (Multiple) as appropriate, then push the **ADJUST** knob.
4. Close the menu.

1.36.4 Trail level

The level, or intensity, of the afterglow that extends from radar targets can be selected as below.

1. Select the [TRAIL] box at the bottom-right corner of the screen, then press the **right button** to display the [TRAIL MENU].
2. Select [TRAIL LEVEL], then push the **ADJUST** knob.
3. Select the appropriate setting, then push the **ADJUST** knob. The higher the number, the greater the intensity of the afterglow.
4. Close the menu.

1.36.5 Narrow trails (Non-IMO only)

Target trails can be painted with thinner lines if desired. This can be useful when there are a lot of targets on the screen and it is hard to distinguish one from another.

1. Select the [TRAIL] box at the bottom-right corner of the screen, then press the **right button** to display the [TRAIL MENU].
2. Select [NARROW TRAIL], then push the **ADJUST** knob.
3. Select the appropriate setting from [OFF], [1] or [2], then push the **ADJUST** knob. [2] is thinner than [1].
4. Close the menu.

1.36.6 How to hide the trails temporarily

Following the procedure outlined in "Trail time" on page 1-44, set the trail time to [OFF]. The trails are hidden from view, but are continued. To show the trails again, repeat the procedure, setting the trail time to any interval other than [OFF].

1.36.7 Trail stabilization in true motion

True motion trails can be ground stabilized or sea stabilized. The [TRAIL] box shows current stabilization as "TRUE-G" or "TRUE-S". To change stabilization mode, open the [SHIP SPEED MENU] menu and set [SHIP SPEED] to [LOG(BT)] (ground stabilization) or [LOG(WT)] (sea stabilization).

1.36.8 How to erase/restart trails

All trails can be erased (including those in the memory) and restarted to start fresh trails.

To erase trails, select the [TRAIL] box, then press and hold the **left button**. You can also press and hold **TGT TRAIL** key to erase trails.

1.36.9 How to prevent sea clutter in true trails

You can prevent the display of sea clutter in true trails about your ship to clear the radar picture. Your ship's trails can also be shown or hidden.

1. Select the [TRAIL] box at the bottom-right corner of the screen, then press the **right button** to display the [TRAIL MENU].
2. Select [OS TRAIL], then push the **ADJUST** knob.
3. Select [OFF], [1] or [2] as appropriate, then push the **ADJUST** knob.

Option	Show own ship's trail	Prevent sea clutter in true trails
[OFF]	No	No
[1]	Yes	Yes
[2]	No	Yes

4. Close the menu.

1.36.10 How to show/hide land trails (Non-IMO only)

You can improve the on-screen display visibility by hiding trails generated by land-masses and non-moving objects. Hiding the trails has the following possible benefits:

- Land-masses have no trail, allowing you to use relative trails near coastlines.
- Only moving echoes create a trail, improving target identification.

1. Select the [TRAIL] box at the bottom-right corner of the screen, then press the **right button** to display the [TRAIL MENU].
2. Select [HIDE LAND TRAILS(T)] or [HIDE LAND TRAILS(R)] as appropriate, then push the **ADJUST** knob.
3. Referring to the table below, select the appropriate setting, then push the **ADJUST** knob.

Setting	Trails for non-moving objects		Trails for moving objects
	Large objects	Small objects	
[OFF]	Trails are shown	Trails are shown	Trails are shown
[1]	Trails are hidden	Trails are shown	Trails are shown
[2]	Trails are hidden	Trails are hidden	Trails are shown

4. Close the menu.

Note: When option [1] or [2] is selected trails for echoes outside the displayed area are not generated. It is important to note that, where the displayed area is moved by functions such as off-centering or true motion, newly displayed echoes do not have trails.

1.37 Target Analyzer (Non-IMO only)

The target analyzer function analyzes echoes and assists the operator to determine dangerous targets. This function is particularly useful under heavy rain/snow or where there is surface reflection, which can cause interference and noise.

The target analyzer function can also place hatching over heavy rain areas, reducing the visible interference and allowing a clearer view of potential targets.

Echoes are displayed in five different colors to assist the operator in identifying targets. The colors and their respective echoes change depending on the echo color selected from the [BRILL] menu (see section 1.43.2) are shown in the table below.

Echo	Selected echo color					
	YEL	GRN	WHT	AMB	M-GRN	M-CYA
Surface reflection	Green	Green	Green	Green	Green	Green
Rain	Gray	Gray	Gray	Gray	Gray	Gray
Moving target	Red	Red	Red	Red	Pink	Pink
Approaching target	Pink	Pink	Pink	Pink	White	White
Other echoes	Yellow	Green	White	Amber	Red to green	Red to blue

The following example figures show the manner in which this function affects displayed echoes.

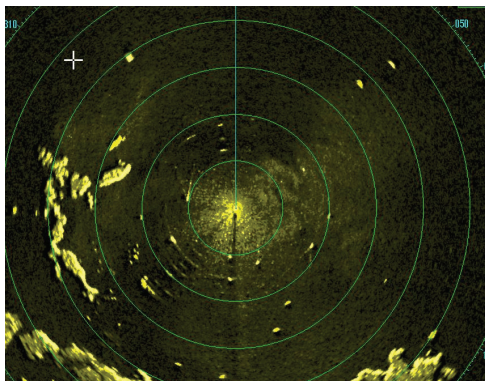

No echo adjustment
(Target analyzer off, EAV off, hatching off)
Rain, moving targets and surface reflections are all displayed with no filtering.

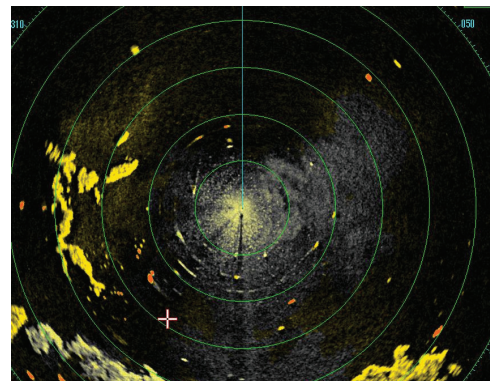

Minimal echo adjustment
(Target analyzer on, EAV off, hatching off)
Echoes are colored, surface reflections are filtered, rain is displayed.

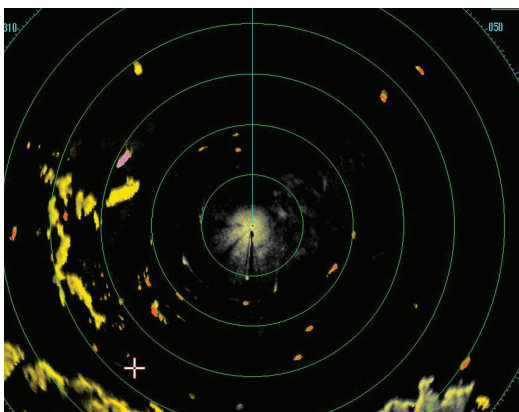

Moderate echo adjustment
(Target analyzer on, EAV on, hatching off)
Echoes are colored, surface reflections and rain are filtered.

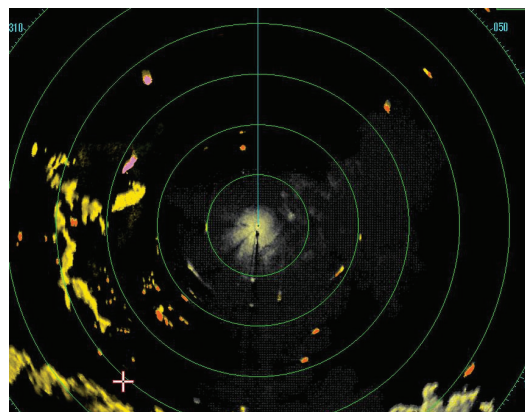

Maximum echo adjustment
(Target analyzer on, EAV on, hatching on)
Echoes are colored, surface reflections are filtered, rain is displayed in gray colored hatching.

1. OPERATIONAL OVERVIEW

Note 1: This function works best when the settings for [GAIN], [STC], [RAIN], [NOISE REJECT] and [VIDEO CONTRAST] are properly adjusted (surface reflections are displayed in green and rain is displayed in gray).

Note 2: This function recognizes moving targets as approaching targets. Buoys and other stationary objects are not recognized as approaching targets by this function.

Note 3: The target analyzer function requires a short period of time to analyze echoes and display them on-screen. If your antenna revolves at more than 40 rpm, moving targets may not be displayed correctly. For this reason, caution is advised when using the target analyzer function.

What is “hatching”?

Where echo averaging may hide light rain on the display, the hatching feature, when activated, places a gray “veil” over the areas where rain is detected. This allows the operator to see where the rain is without affecting the quality of the displayed echoes.

1.37.1 How to activate/deactivate the target analyzer

1. Select the [CUSTOMIZE ECHO] box, then press the **right button**.
2. Select [TARGET ANALYZER], then push the **ADJUST** knob.
3. Select [OFF] to deactivate the function, or [ON] to activate the function, then push the **ADJUST** knob.
4. Select [HATCHING], then push the **ADJUST** knob.
5. Select [OFF] to deactivate the function, or [ON] to activate the function, then push the **ADJUST** knob.
6. Close the menu.

1.38 Target Alarm

The target alarm serves to alert the navigator to targets (ships, landmasses, etc.) entering a specific area, with audiovisual alerts.

The target alarm zone has a fixed width of 0.5 nm in the radial direction (depth) and is adjustable from 3.0 to 6.0 nm (target alarm zone 1) and any distance (target alarm zone 2). On the non-IMO radar the boundaries can be set at any distance. On any radar type the sector of the zone can be set from 0 to 360 degrees in any direction.



CAUTION

- ♦ The alarm should not be relied upon as the sole means for detecting possible collision situations.
- ♦ A/C SEA, A/C RAIN and GAIN controls should be properly adjusted to be sure the alarm system does not overlook target echoes.

Note: The [ALR1] and [ALR2] boxes are not displayed when the setting for [AZ/ALR SELECT] in the [TT•AIS] menu is set to the default setting [ACQUISITION ZONE]. To enable this function, set [AZ/ALR SELECT] in the [TT•AIS] menu to [TARGET ALARM ZONE].

1.38.1 How to set a target alarm

The procedure below shows how to set a target alarm using the figure below as an example.

1. Place the cursor in the [ALR1] or [ALR2] box as appropriate, then press the left button. The cursor jumps into the operational display area and the indication "SET" appears inside the target alarm box selected.

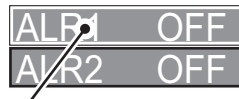

ALR1 selected and highlighted



ALR1 ready to be set

2. Using the Touchpad, move the cursor to Point A, then press the **left button**.
3. Using the Touchpad, move the cursor to Point B, then press the **left button**. "SET" is replaced with "WORK" in the [ALR1] box indication. The target alarm zone's lines are shown as dashed lines.

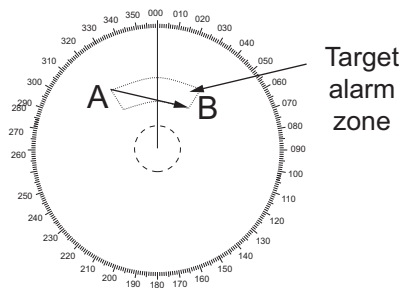

Target alarm zone

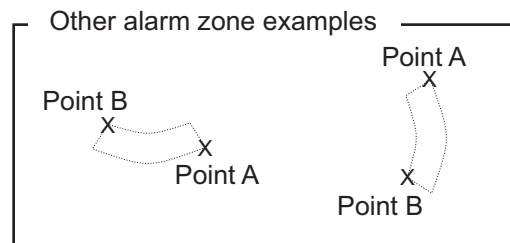

Note 1: To create a 360° alarm zone, set Point B at the same location as Point A.

Note 2: Two alarm zones can be set simultaneously. The second alarm zone is only available when the first alarm zone is active, however.

Note 3: When the target alarm zone is not within the range in use the indication "UP RNG" appears to the right of the target alarm box. In this case select a range that will display the target alarm zone.

1.38.2 How to mute the target alarm

A target in the target alarm zone produces both visual (flashing) and audible (beep) alarms. To silence the audio alarm select the appropriate target alarm box then press the **left button**. The target alarm box indication shows "ALR× MUTE". This will deactivate the audio alarm but will not stop the flashing of the offending target. You can also stop the alarm by deactivating the target alarm zone (see section 1.38.3).

To reactivate the audio alarm, select the target alarm box then press the **left button** until the target alarm box shows "ALR× WORK".

1.38.3 How to deactivate a target alarm

Select the target box to be deactivated, then press and hold the **left button**.

Note: When both [ALR1] and [ALR2] are active, [ALR2] must be deactivated before [ALR1] can be deactivated.

If [ALR1] and [ALR2] are active when you try to deactivate [ALR1], the system releases two audible beeps and shows the message "DELETE ALR2 FIRST".

1.38.4 How to change target alarm attributes

You can select the echo strength level that triggers the alarm, the condition that generates the alarm and the volume of the audio alarm as follows:

1. Open the [MAIN MENU].
2. Select [ALERT], then push the **ADJUST** knob.
3. Select [TARGET ALARM], then push the **ADJUST** knob.
4. Select [ALR1 MODE] or [ALR2 MODE] as appropriate, then push the **ADJUST** knob.
5. Select [IN] or [OUT] as appropriate, then push the **ADJUST** knob.
[IN]: Targets entering the alarm zone trigger the alarm.
[OUT]: Targets leaving the alarm zone trigger the alarm.
6. Select [LEVEL], then push the **ADJUST** knob.
7. Select the appropriate level of echo strength to trigger the alarm, then push the **ADJUST** knob. [1] reduces the trigger threshold and detects weak echoes; [4] increases the trigger threshold and ignores weaker echoes.
8. Close the menu.

1.39 PI (Parallel Index) Lines

PI lines are useful for keeping a constant distance between own ship and a coastline or a partner ship when navigating. Up to six sets of PI lines are available depending on the maximum number of PI lines selected on the menu.

Max. 1 PI line: Six sets of PI lines (PI1 to PI6)

Max. 2, 3 or 6 PI lines: Four sets of PI lines (PI1 to PI4)

You can control the presentation and interval of the PI lines from the [PI Line] box, which is at the lower-left corner of the screen.

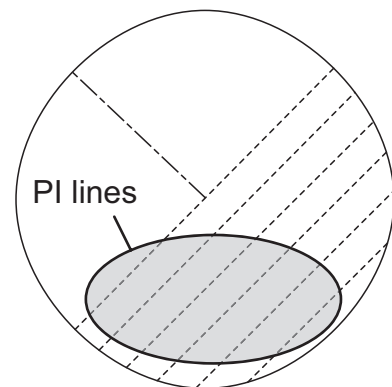

1.39.1 How to set the maximum number of lines to display

The maximum number of PI lines to display can be selected from [1], [2], [3] or [6] lines as below. The actual number of lines visible can be less depending on line interval.

1. Open the [MAIN MENU].
2. Select [NAVTOOL], then push the **ADJUST** knob.
3. Select [PI LINE], then push the **ADJUST** knob.
4. Select [SET ALL PI LINE], then push the **ADJUST** knob.
5. Select the appropriate option, then push the **ADJUST** knob.
6. Close the menu.

1.39.2 How to change PI line bearing and interval

1. If not already displayed, show a PI line, referring to subsection 1.39.1.
2. Place the arrow on the PI line orientation in the [PI Line] box.



3. Rotate the **ADJUST** knob to adjust the PI line bearing, between 000.0° to 359.9°. Enter a negative value to move the PI line to the opposite side of the PI line passing through the own ship position.
4. Place the cursor on the PI line interval.
5. Rotate the **ADJUST** knob to change the PI line interval.

1.39.3 How to change the PI line bearing reference

PI line bearing reference can be relative to own ship's heading (Relative) or referenced to North (True) as below.

Note: This function is not available with IMO type radars in this series. The setting is fixed to [TRUE].

1. Open the [MAIN MENU].
2. Select [NAVTOOL], then push the **ADJUST** knob.
3. Select [PI LINE], then push the **ADJUST** knob.
4. Select [PI LINE BEARING], then push the **ADJUST** knob.
5. Select [REL] or [TRUE] as appropriate, then push the **ADJUST** knob.
6. Close the menu.

1.39.4 How to change the PI line orientation

PI lines orientation can be selected from parallel or perpendicular. This function is available when [SET ALL PI LINE] in the [PI LINE] menu is set for other than [1].

1. Open the [MAIN MENU].
2. Select [NAVTOOL], then push the **ADJUST** knob.
3. Select [PI LINE], then push the **ADJUST** knob.
4. Select [PI LINE MODE], then push the **ADJUST** knob.
5. Select [PARALLEL] or [PERPENDIC] as appropriate, then push the **ADJUST** knob.
6. Close the menu.

1.39.5 How to reset the PI lines to default (ship's heading)

You can automatically return PI lines to default orientation (ship's heading), 0-degrees for parallel orientation, 90-degrees for perpendicular orientation. This is faster than doing it manually.

From the PI line box

Place the cursor inside the PI line box, then press and hold the **left button**.

From the menu

1. Open the [MAIN MENU].
2. Select [NAVTOOL], then push the **ADJUST** knob.
3. Select [PI LINE], then push the **ADJUST** knob.
4. Select [RESET PI LINE], then push the **ADJUST** knob.
5. Select [YES], then push the **ADJUST** knob.
6. Close the menu.

1.39.6 How to change PI line length

You can change the length of the PI lines. This function is only available when [SET ALL PI LINE] in the [PI LINE] menu is set to [1]. If not already displayed, you can show PI lines for which you wish to change the length by referring to subsection 1.39.1.

1. Open the [MAIN MENU].
2. Select [NAVTOOL], then push the **ADJUST** knob.
3. Select [PI LINE], then push the **ADJUST** knob.
4. Select [TRUNC RANGE 1], then push the **ADJUST** knob.
5. Select [ON], then push the **ADJUST** knob.
6. Rotate the **ADJUST** knob to adjust the front PI line length. The available range is 0.000 NM to 24.000 NM. All PI lines beyond this mark will be hidden.
7. Select [TRUNC RANGE 2], then push the **ADJUST** knob.
8. Select [ON], then push the **ADJUST** knob.
9. Rotate the **ADJUST** knob to adjust the rear PI line length. The available range is 0.000 NM to 24.000 NM. All PI lines beyond this mark will be hidden.
10. To change the length of other PI lines, activate the line you wish to adjust, then repeat steps 1 through 9.
11. Close the menu.

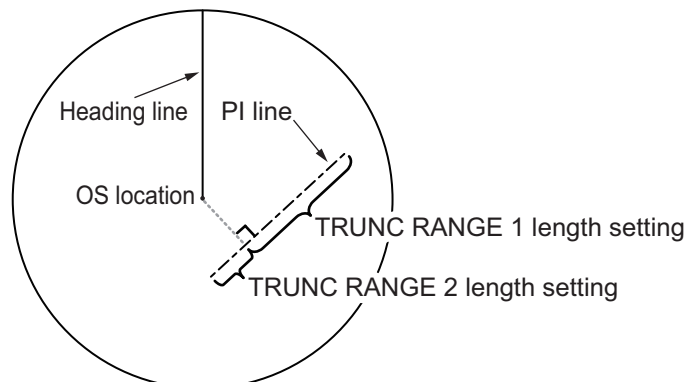

1.40 Zoom

The zoom function enlarges an area of interest as large as twice the normal viewing size, in the [INFORMATION BOX]. Zoom can be selected using the control unit or from a preset function key (see section 1.9 for how to assign functions to the function keys).

Zoom is not available when the [INFORMATION BOX] setting for [TARGET DATA] is [LARGE].

To enable/disable the zoom magnification, select the appropriate zoom setting ([2TIMES]: Enables magnification at 2×, or [3TIMES]: Enables magnification at 3×) from the [ZOOM] option in the [INFORMATION BOX] menu. (See section 1.45.)

1. Select the operational display area, then press the **right button** to display the [CURSOR] context menu.
2. Select [ZOOM], then push the **ADJUST** knob.
3. Place the cursor inside the operational display area, then press the **left button**. The cursor is now displayed with a zoom box.
4. Place the cursor and zoom box at the location you wish to zoom, then press the **left button**.
5. Press the **right button** to complete the procedure. The selected area is displayed on the right-side of the screen and the cursor returns to normal shape.

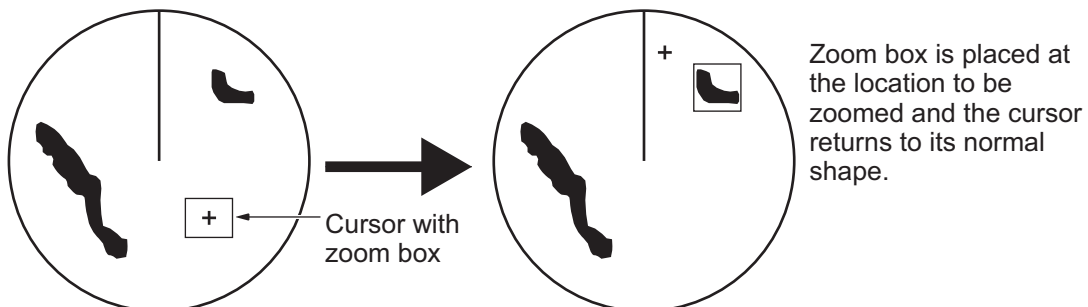

To disable the zoom function, repeat steps 1 to 3. At step 3, the zoom box is removed from the cursor.

Note: Where the zoom function is assigned to a function key (**F1**, **F2** or **F3**), press the function key to cycle through the zoom settings in the following order: [OFF] → [2TIMES] → [3TIMES] → [OFF]...

This operation works in direct relation with the settings selected from the [ZOOM] option in the [INFORMATION BOX] menu. To use the zoom function on a different area, do the procedure (step 1 to step 5) listed above.

1.41 How to Use Marks

Select the [MARK] box at the bottom of the screen then press the **right button** to open the [MARK] context menu.

Marks can be entered at any location inside the operational display area, however, no mark can be entered at the location of an on-screen box. A total of 5,000 marks can be inscribed at any one time.

You can mark any prominent target or a point of particular interest using the mark feature.

Note: The location and orientation of mark symbols and mark lines can change, depending on the display presentation mode, as shown in the table below.

[MARK MENU]	
1	ORIGIN MARK [STAB GND] / STAB SEA
2	MARK KIND ORIGIN MARK(No.) / [ORIGIN MARK(SYM)] / MAP MARK / WP 1~50 / WP 51~98 /
8	MARK POSITION [CURSOR] / OS / L/L
9	MARK COLOR RED / GRN / BLU / YEL / [CYA] / MAG / WHT
0	MAP•MARK MENU

Presentation mode	Mark symbol	Mark line
HEAD UP RM/STERN UP RM/STAB HEAD UP RM	Location is changed according to heading and own ship position. Orientation is unchanged.	Location and orientation are changed according to heading and own ship position.
COURSE UP RM/NORTH UP RM/NORTH UP TM	Location is changed according to own ship position. Orientation is unchanged.	Location and orientation are changed according to own ship position.

1.41.1 How to select a mark type

1. Select the [MARK] box at the bottom of the screen, then press the **right button** to open the [MARK] context menu.
2. Select [MARK KIND], then push the **ADJUST** knob.
3. Select the appropriate type of marker, referring to the table below, then push the **ADJUST** knob.

Mark kind	Description
[ORIGIN MARK(No.)]	Inscribes the standard origin mark symbol, with mark number.
[ORIGIN MARK(SYM)]	Inscribes the standard origin mark symbol, without mark number.
[MAP MARK]	Inscribes the selected map mark.
[WP1-50]	Inscribes waypoint marker 1 through 50.
[WP51-98]	Inscribes waypoint marker 51 through 98.

4. Close the menu.

1.41.2 How to select the mark inscription position

You can select the location at which the marker is inscribed from the following:

Location	Description
[CURSOR]	You can select the location using the Touchpad.
[OWN SHIP]	Marker is placed at own ship position.
[L/L]	Marker is placed at the co-ordinates selected.

1. Select the [MARK] box at the bottom of the screen, then press the **right button** to open the [MARK] context menu.
2. Select [MARK POSITION], then push the **ADJUST** knob.
3. Referring to the table above, select the appropriate location, then push the **ADJUST** knob.

How to set the co-ordinates

Where [MARK POSITION] is set to [L/L], the co-ordinates settings are displayed. Co-ordinates can be set one digit at a time, as shown in the figure below.

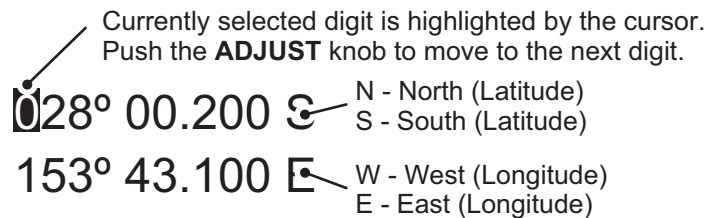

- 1) Rotate the **ADJUST** knob to change the digit, then push the **ADJUST** knob to move to the next digit.
- 2) Repeat step 1 to adjust the Latitude and Longitude as appropriate.
4. Close the menu.

1.41.3 How to select the mark color (non-IMO type only)

Non-IMO type radars of this series allow the change of mark colors. For IMO type radars, the color is fixed and cannot be changed.

1. Select the [MARK] box at the bottom of the screen, then press the **right button** to open the [MARK] context menu.
2. Select [MARK COLOR], then push the **ADJUST** knob.
3. Select the appropriate color. Available options are shown in the table below.

Menu indication	Color	Menu indication	Color
RED	Red	CYA	Cyan
GRN	Green	MAG	Magenta
BLU	Blue	WHT	White
YEL	Yellow		

1.41.4 How to inscribe marks

You can inscribe marks anywhere inside the operational display area, however, marks cannot be inscribed in the same location as a menu box.

1. Select the [MARK] box. The [MARK] box is now highlighted.
2. Rotate the **ADJUST** knob to select the appropriate mark symbol or number.
3. Place the cursor on the location (inside the operational display area) you wish to inscribe the mark, then press the **left button** to anchor the mark.
4. Repeat steps 1 to 3 for multiple mark inscription, or press the **right button** to complete the procedure.

1.41.5 How to set origin mark stabilization

Origin marks can be geographically fixed (ground stabilized) or moving (sea stabilized).

1. Select the [MARK] box at the bottom of the screen, then press the **right button** to open the [MARK] context menu.
2. Select [ORIGIN MARK], then push the **ADJUST** knob.
3. Select [STAB GND] or [STAB SEA] as appropriate, then push the **ADJUST** knob.
4. Close the menu.

1.41.6 How to delete marks

Marks can be deleted one at a time, or all at once.

How to delete marks individually

1. Select the operational display area, then press the **right button** to show the [CURSOR] menu.
2. Select [MARK DELETE], then push the **ADJUST** knob. The cursor changes to a highlighted cursor.
3. Place the highlighted cursor on the mark to be deleted, then push the **ADJUST** knob.
4. Repeat step 3 to delete another mark, or press the **right button** to return the cursor to normal function.

How to delete all marks

1. Open the [MAIN MENU].
2. Select [MARK], then push the **ADJUST** knob.
3. Select [DATA DELETE], then push the **ADJUST** knob.
4. Select [MARK ALL DELETE], then push the **ADJUST** knob. A confirmation message appears.
5. Select [YES], then push the **ADJUST** knob.
6. Close the menu.

1.41.7 How to hide the heading line marker

The heading line is a line from the own ship position to the outer edge of the radar display area and appears at zero degrees on the bearing scale in HEAD UP mode. The orientation of the line changes the orientation depending on the ship orientation in NORTH UP and True Motion modes.

To temporarily extinguish the heading line to look at targets existing dead ahead of own ship, press the **HL OFF** key on the keyboard, or use the Touchpad to select the [HL OFF] box at the left of the display then press the **left button**. In addition to the heading line, the stern marker and all graphics within the effective display are also erased. To redisplay the heading line, etc., release the key or the **left button**.

1.41.8 How to hide/show the stern mark

The stern marker, which is a dotted line, appears opposite to the heading line. To display or erase this marker do the following:

1. Open the [MAIN MENU].
2. Select [MARK], then push the **ADJUST** knob.
3. Select [STERN MARK], then push the **ADJUST** knob.
4. Select [ON] or [OFF] as appropriate, then push the **ADJUST** knob.
5. Close the menu.

1.41.9 How to set up the own ship symbol

The own ship symbol marks own position on the display. It can be turned on or off and its configuration selected from the [MARK] menu. Two configurations are available: minimized symbol and scaled symbol. If the largest dimension of the symbol gets smaller than 6 mm, the scaled symbol will disappear and the own ship mark will be shown as a minimized symbol. The scaled symbol is scaled to indicate the length and beam of the vessel. Ship's dimensions should be entered at installation to use the scaled ship symbol.

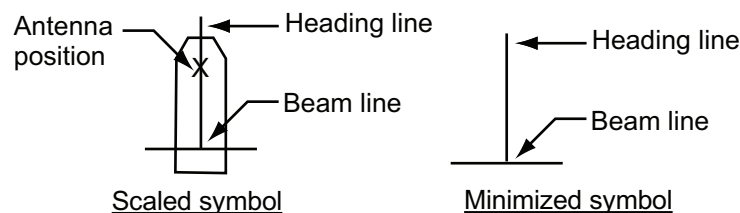

1. Open the [MAIN MENU].
2. Select [MARK], then push the **ADJUST** knob.
3. Select [OWN SHIP MARK], then push the **ADJUST** knob.
4. Select [MIN] or [SCALED] as appropriate, then push the **ADJUST** knob.
5. Close the menu.

1.41.10 How to use the INS marker

You can receive predicted position data by connecting this radar to an INS.

1. Open the [MAIN MENU].
2. Select [MARK], then push the **ADJUST** knob.
3. Select [INS MARK], then push the **ADJUST** knob.
4. Select [PREDICTOR], then push the **ADJUST** knob.
5. Select [ON], then push the **ADJUST** knob.
6. Close the menu.

1.41.11 How to show/hide radar map marks

You can show or hide marks on the radar map.

1. Place the cursor on the [MARK] box at the bottom of the screen, then press the **right button** to open the [MARK] context menu.
2. Select [MAP DISPLAY], then push the **ADJUST** knob.
3. Select [ON] or [OFF] as appropriate, then push the **ADJUST** knob.
4. Close the menu.

1.41.12 How to set the barge marker

You can mark the locations of barges on the display with icons. Set up barge information as follows:

1. Open the [MAIN MENU].
2. Select [MARK], then push the **ADJUST** knob.
3. Select [BARGE], then push the **ADJUST** knob.
4. Select [BARGE MARK], then push the **ADJUST** knob.
5. Select [ON] to display barge marks, [OFF] to hide barge marks, as appropriate, then push the **ADJUST** knob.
6. Select [BARGE SIZE], then push the **ADJUST** knob. Use the **ADJUST** knob to enter the [LENGTH] and [WIDTH] of the barge.
Rotate the **ADJUST** knob to increase or decrease the value of the highlighted digit.
7. Select [ARRANGEMENT], then push the **ADJUST** knob. This item lets you set a single barge or a barge chain. Select one of the five arrangements and rotate the **ADJUST** knob. Select number of barges (max. 9) to display. As you rotate the **ADJUST** knob the squares light or extinguish and the number of barges selected appears at the right side.

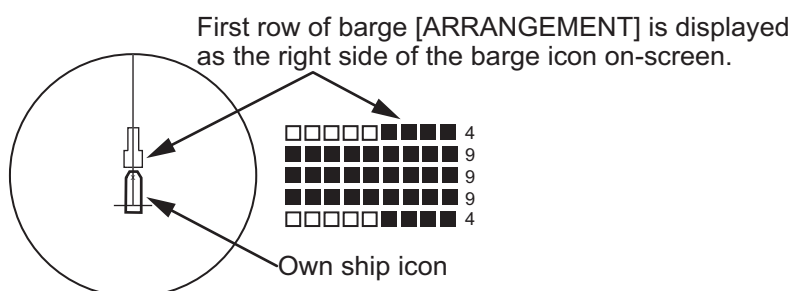

8. Close the menu. The barge mark is now displayed as shown in the figure above.

1.42 Drop Mark

The operator can inscribe a drop mark at a selected location to find the range and bearing from own ship to the mark. This can be useful for marking a point to avoid while navigating to a destination.

To active the drop mark feature, do the following:

1. Open the [MAIN MENU].
2. Select [MARK], then push the **ADJUST** knob.
3. Select [ON] to enable [DROP MARK]. Two indications appear at the bottom of the screen.

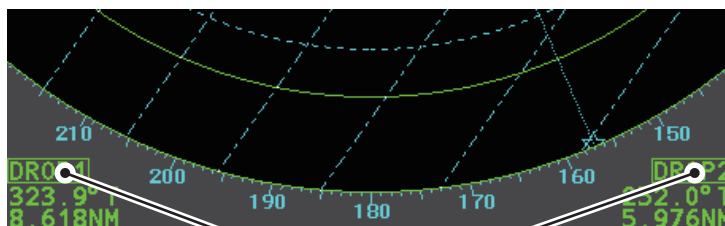

Drop mark boxes show the mark number, bearing and range to the mark.

4. Close the menu.

1.42.1 How to inscribe a drop mark

1. Select a drop mark box, then press the **left button**.
2. Place the cursor at the location to inscribe the drop mark, then press the **left button**.

The drop mark box shows the range and bearing to the marked location.

1.42.2 How to erase drop marks

Select the drop mark to be erased, then press and hold the left button. The mark is erased and the range/bearing indications are no longer shown.

1.43 How to Adjust Brilliance of On-screen Data

On-screen markers and alphanumeric readout brilliance can be adjusted using the following procedure:

1. Place the cursor on the [BRILL] box at the right of the screen, then press the **right button**. The [BRILL] menu appears.
2. Select the appropriate item to adjust, then push the **ADJUST** knob.

Menu item	Description
ECHO COLOR	Adjusts echo color brilliance.
PALETTE	Adjusts background brilliance (see subsection 1.43.1).
CONTROL PANEL	Adjusts control panel key brilliance.
CHARACTER	Adjusts on-screen text brilliance.
CURSOR	Adjusts cursor brilliance.
ECHO	Adjusts the echo brilliance.
TRAIL	Adjusts echo trail brilliance.
HL	Adjusts heading line brilliance.
RING	Adjusts range ring brilliance.
BEARING CURSOR	Adjusts bearing cursor brilliance.
EBL	Adjusts EBL line brilliance.
VRM	Adjusts VRM line brilliance.
PI LINE	Adjusts PI line brilliance.
TT SYMBOL	Adjusts target trail symbol brilliance.
AIS SYMBOL	Adjusts AIS symbol brilliance.
L/L GRID	Adjusts latitude/longitude grid brilliance.
MARK	Adjusts marks brilliance (all marks).

3. Rotate the **ADJUST** knob to select the appropriate brilliance setting, then push the **ADJUST** knob.
4. Close the menu.

1.43.1 How to change color palettes

This radar provides six sets of color and brilliance sets to match any ambient lighting condition and can be assigned to a [BRILL] box preset.

1. Select the [BRILL] box at the bottom-left of the screen, then press the **right button**. The [BRILL] menu appears.
2. Select [PALETTE], then push the **ADJUST** knob.
3. Select the appropriate palette, then push the **ADJUST** knob. The default settings for each palette are shown in the table below.

PALETTE	BRILL	PANEL	OTHERS	TEXT COLOR	BCKGRND/CIRCLE
DAY-GRY	100	15	15	GREEN	GRY/BLK
DAY-BLU	100	15	15	WHITE	BLU/BLU
DUSK-GRY	40	10	15	GREEN	GRY/BLU
DUSK-BLU	40	10	15	WHITE	BLU/BLU
NIGHT-GRY	4	5	15	AMBER	GRY/BLK
NIGHT-BLU	4	5	15	WHITE	BRT-BLU/BRT-BLU

4. Close the menu.

How to assign/change the brilliance presets

1. Place the cursor on the BRL indication inside the [BRILL] box.
2. Press the left button to cycle through the pre-sets. There are four available: [BRL1], [BRL2], [BRL3] and [BRL4].
3. To change the palette for a preset, press the **right button** with the preset selected. The [BRILL] menu appears.
4. Follow steps 2 to 4 in "How to change color palettes" on page 1-60.
5. Repeat the process to change other presets' palettes.

Place cursor here, then press the **left button** to change brilliance preset, **right button** to open the [BRILL] menu.



1.43.2 How to change the echo color

1. Select the [BRILL] box at the bottom-left of the screen, then press the **right button**. The [BRILL] menu appears.
2. Select [ECHO COLOR], then push the **ADJUST** knob.
3. Select the appropriate color, then push the **ADJUST** knob. The available options are listed in the table below.

Color	Description/remarks
YEL	Yellow echo (default setting)
GRN	Green echo
WHT	White echo
AMB	Amber echo
M-GRN	Red echo, gradually changes to green color as the echo weakens.
M-CYA	Red echo, gradually changes to cyan color as the echo weakens.

1.44 How to Display and Set Up Navigational Data

Wind, depth, ocean current, water temperature, date and time and waypoint data can be displayed on this radar, however appropriate sensors are required.

1.44.1 How to set up the navigational data

1. Open the [MAIN MENU].
2. Select [INFORMATION BOX], then push the **ADJUST** knob.
3. Select [SET NAV DATA], then push the **ADJUST** knob.
4. Referring to the table below, select the appropriate menu item, then push the **ADJUST** knob.

Menu item	Available settings
DEPTH	[OFF], [ON] (m, ft)
DEPTH GRAPH SCALE	[10], [20], [50], [100], [200], [500] (m)
DEPTH MARK	[000] to [500] (m)
CURRENT	[OFF], [ON]
WIND	[OFF], [ON] (kn, m/s)
WIND STAB	[APPARENT], [NORTH], [THEORETICAL]
TEMPERATURE	[OFF], [ON] (°C, °F)
WPT DATA	[OFF], [REL], [TRUE]

5. Referring to the available options listed in the table above, select the appropriate setting, then push the **ADJUST** knob.
6. Close the menu.

1.44.2 How to display navigational data

1. Open the [MAIN MENU].
2. Select [INFORMATION BOX], then push the **ADJUST** knob.
3. Select [NAV DATA], then push the **ADJUST** knob.
4. Select [ON] to display navigational data, [OFF] to hide navigational data, then push the **ADJUST** knob.
5. Close the menu.

1.45 How to Use the Information Box

The information box shows target data, navigational data and zoomed areas of the radar display. To set up the information box, do the following:

1. Open the [MAIN MENU].
2. Select [INFORMATION BOX], then push the **ADJUST** knob.
3. Select and set the appropriate menu item, referring to the table below.
4. Close the menu.

[INFORMATION BOX]	
1	BACK
2	NAV DATA OFF / ON
3	[SET NAV DATA]
4	ZOOM OFF / 2TIMES / 3TIMES
5	ZOOM DISPLAY STAB GND / STAB HDG / STAB NORTH / TT TRACK
6	TARGET DATA 1BOX / 2BOX / LARGE

Menu item	Settings	Description
[NAV DATA]	<ul style="list-style-type: none"> • OFF • ON 	<ul style="list-style-type: none"> • Disable navigational data display. • Enable navigational data display.
[SET NAV DATA]	See section 1.44 for details.	Set up the format in which various navigational data is displayed in the [INFORMATION BOX]. See section 1.44 for details.
[ZOOM]	<ul style="list-style-type: none"> • OFF • 2TIMES • 3TIMES 	<ul style="list-style-type: none"> • Disable zoom magnification. • Set zoom magnification at 2x. • Set zoom magnification at 3x.
[ZOOM DISPLAY]	<ul style="list-style-type: none"> • STAB GND • STAB HDG • STAB NORTH • TT TRACK 	<ul style="list-style-type: none"> • Ground stabilized zoom (Geographically fixed). • Heading stabilized zoom (Relative). • North stabilized zoom (True). • Tracked targets are zoomed.
[TARGET DATA]	<ul style="list-style-type: none"> • 1BOX • 2BOX • LARGE 	See figure below.

Zoom and navigational data are displayed here.

Only TT/AIS data is displayed in the lower half of the information box.

1BOX

Zoom and navigational data are displayed here, but can be hidden by TT/AIS data.

Only TT/AIS data is displayed in the lower half of the information box.

2BOX

Only TT/AIS Data is displayed in the large box. Up to two AIS objects or up four TT targets

LARGE

- TT/AIS data displayed in the information box is shown in order of acquisition in the bottom half of the box.
- When using the 2BOX setting and the bottom half of the information box is full, the upper half is overlaid with the newly acquired TT/AIS data.
- When the target data is no longer displayed (TT is cancelled, etc.) in the upper box, the previous display is restored.
- Each box may display up to two TT data or one AIS data.

1.46 Interswitch

The interswitch of this radar uses an Ethernet to transfer video and control signals. A digital signal transfers the video and control signals. You can connect two antennas and two display units. Set radar display and antenna groups from the [ANTENNA SELECT] display.

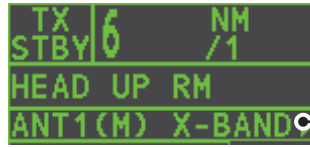

Antenna box
ANT1 (or ANT2): indicates antenna selected
(M) or (S): indicates antenna is (M)aster or (S)lave
X-Band: indicates the antenna bandwidth

When you switch to a different antenna, the heading skew and timing adjustment (set at installation) for that antenna are automatically applied.

The [ANTENNA] box at the upper left position shows current antenna selection.

1.46.1 How to display antenna information

You can display antenna information by highlighting the [ANTENNA] box, then pressing the **right button**. The [ANT SELECT] context menu appears.

The following information is displayed in the [ANT SELECT] context menu.

- Radar band, output power and antenna position of each antenna currently powered. (If an antenna is not powered, its data area is blank.)
- Current antenna and display combinations.



Using the information displayed in this example the antenna system configuration would look something like this.

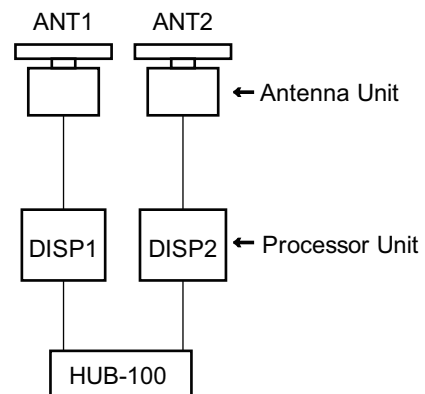

1.46.2 How to preset antenna and display combinations

You can preset the antenna and display combinations for each antenna and display in the radar system. As an example, the procedure below shows how to select the no. 1 antenna unit for the no. 2 display unit.

1. Highlight the [ANTENNA] box, then press the **right button** to open the [ANT SELECT] menu.
2. Select the display unit for which to select an antenna (at the next step). For example, select [DISP2] to select the no. 2 display unit.
3. Select [ANT 1] and [M].
4. Repeat steps 2 and 3 to set other display and antenna combinations.
5. Click [STORE INTER-SW] and select [YES] to save your selections.
6. Close the menu.

Antenna selection considerations

- An antenna unit cannot be controlled from multiple display units. Select one Master display unit for one antenna unit. If two antenna units are set as masters, the display last-set as master becomes the master and all other displays are automatically changed to slave.
- An antenna unit without a Master display cannot be selected on the sub display units. If there is no antenna unit set as master, the lowest number display is automatically set as master.
- If the Alert 740 "EXT RADAR ERROR" appears, do one of the following, as applicable:
 - If only your antenna is not displayed on the [ANT SELECT] display, the LAN line in the Processor Unit may be faulty. In this case, use the standalone mode.
 - If the antenna that was in use does not appear on the [ANT SELECT] display, the LAN line in other Processor Unit may be faulty. In this case, see the preceding page for how to select a different antenna unit
- When the Network fails, the Interswitch does not work, but standalone operation is possible.
- Radar functions are controlled independently, dependently or commonly depending on selection as Master or Slave (see the table below).

Radar Functions	Control	Master Display Option	Slave Display Option
AIS function	Independent	Desired value can be set	Desired value can be set
Brilliance			
Echo trails			
EBL			
Lat/long data			
Presentation mode			
Speed data			
Target alarm			
TT, AIS on/off			
TT, AIS track interval			
Vector mode			
Vector time			
VRM			
Wiper			
Zoom			
TT COLLISION alarm			
Range (Sampling at Master)	Independent	Desired value can be set (Echo Sampling at Master Range)	Desired value can be set
<i>Continued on the following page.</i>			

1. OPERATIONAL OVERVIEW

Radar Functions	Control	Master Display Option	Slave Display Option
A/C SEA	Dependent Control	Desired value can be set	Cannot control
A/C RAIN			
Automatic Clutter Elimination (ACE)			
Gain			
IR			
Echo stretch			
Echo averaging			
Picture setting (Customize echo)			
STBY/TX			
Tuning			
Reference Point			
TT LOST warning	Common Control	Item Commonly Controlled	Item Commonly Controlled
TT alerts ACK			
TT acquire			
TT/AIS AZ			

1.47 Performance Monitor

1. Set the radar to TX (transmit) mode.
2. Open the [MAIN MENU].
3. Select [ECHO], then push the **ADJUST** knob.
4. Select [PERFORMANCE MON], then push the **ADJUST** knob.
5. Select [OFF] or [ON] as appropriate, then push the **ADJUST** knob.
6. Close the menu.

The performance monitor, installed in the antenna unit, produces a visual indication on the radar display screen when the radar transmitter power and radar receiver sensitivity are within the prescribed limits.

1.47.1 How to activate/deactivate the performance monitor

When the performance monitor is active, the indication "PM" appears (in yellow characters) inside the [ALERT] box.

Note: If the blind sector and the direction of the PM antenna overlap one another, turn off the blind sector in order to display echoes correctly.

The radar is automatically set as follows when the performance monitor is activated.

Setting	Setting at PM activation	Adjustable while PM is active	Setting at PM deactivation
GAIN	70 *1	Yes *3	Setting before PM activation.
SEA	0	No	Setting before PM activation.
SEA AUTO	MAN	No	Setting before PM activation.
RAIN	0	No	Setting before PM activation.
RAIN AUTO	MAN	No	Setting before PM activation.

Continued on the following page.

Setting	Setting at PM activation	Adjustable while PM is active	Setting at PM deactivation
TUNE	AUTO	No	Setting before PM activation.
ACE	OFF	No	Setting before PM activation.
ES	OFF	No	Setting before PM activation.
EAV	OFF	No	Setting before PM activation.
IR	2	No	Setting before PM activation.
NOISE REJECT	OFF	No	Setting before PM activation.
VIDEO CONTRAST	4-B	No	Setting before PM activation.
PULSE	LONG	No	Setting before PM activation.
2ND ECHO REJ	ON	No	Setting at PM deactivation.
LOW LEVEL ECHO	Previous setting kept, fixed.	No	Setting before PM activation.
WIPER	OFF	No	Setting before PM activation.
CUSTOMIZE ECHO	Previous setting kept, fixed.	No	Return to active display.
PRESENTATION MODE	No change. *2	Yes	Setting at PM deactivation.
RANGE	24 NM, 24 SM, 48 km	Yes *4	Setting at PM deactivation.
OFF CENTER	OFF	Yes	Setting at PM deactivation.

*1: Gain is automatically set according to [PM GAIN ADJ], if it was adjusted at installation.

*2: [NORTH UP RM] is selected when the [PRESENTATION MODE] is set to [NORTH UP TM].

*3: The setting is not memorized.

*4: The performance monitor is deactivated if the range is changed manually.

1.47.2 How to check the radar's performance



The range scale is automatically set to 24 NM. The radar screen will show arcs. If the radar transmitter and receiver are in good working conditions in as much as the original state when the monitor was turned on, the innermost arcs should appear between 8.0 NM to 19.8 NM. The performance monitor can observe a total of 10 dB loss in transmitter and receiver.

How to set the number of arcs

1. Open the [MAIN MENU].
2. Select [ECHO], then push the **ADJUST** knob.
3. Select [PM ARC], then push the **ADJUST** knob.
4. Select [2], [3], [5] or [6] as appropriate, then push the **ADJUST** knob.
5. Close the menu.

The following figure shows an example where [PM ARC] is set to [5].

1. OPERATIONAL OVERVIEW

Display	Radar State	Display	Radar State
	Transmitter: normal Receiver: normal		Transmitter and receiver: No arc indicates 10 dB loss. Contact your dealer for advice. (For magnetron radars, have a technician check the magnetron.)

Note 1: The lengths of the arcs can vary according to installation environment. Judge the strength of the echo that appears within 60° from the arc location to confirm if the radar is working properly or not.

Note 2: The location of the arcs changes according to the [PM ARC] setting.
Turn the performance monitor off when finished.

1.48 How to Change the Reference Position

The reference position for measurements (range, bearing, etc.) and markers (heading line, stern mark, etc.) can be the radar antenna position ([ANT]) or the consistent common reference point ([CCRP]).

The reference position is a location on own ship to which all horizontal measurements, for example range, bearing, relative course, relative speed, closest point of approach (CPA) or time to closest point of approach (TCPA), are normally referenced.

[CCRP] for this series of radars is fixed at the conning position and [ANT] is fixed at the radar antenna position.

To change the reference position, use the Touchpad to place the cursor over the "REF POINT" indication at the top of the screen, then press the **left button** to select [ANT] or [CCRP] as applicable. You can also change the reference by rotating the **ADJUST** knob when the cursor is placed over the indication.

The position of the own ship marker changes according to reference position as shown below. If the CCRP is positioned outside of the effective display area, the bearing scale is indicated with the appropriate reduced detail.

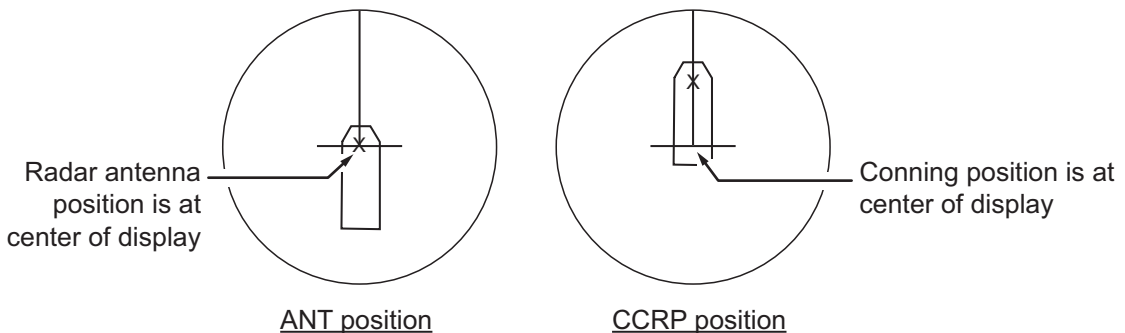

Range and bearing are measured and graphics are drawn according to reference position as in the following table.

Category	Item	Reference point	
		ANT	CCRP
Range and bearing measurements	EBL	Range and bearing measured from antenna position.	Range and bearing measured from CCRP.
	VRM		
	Cursor		
	PI line		
	Range ring		
	Drop mark		
Graphics	Heading line	Drawn from antenna position.	Drawn from CCRP.
	Stern mark		
	Beam line		
	Own ship vector		
	Own ship track		
Bearing cursor		Drawn with antenna position at center.	Drawn with CCRP at center.
Course, speed		Calculated with antenna position at center.	Calculated with CCRP at center.
CPA, TCPA		Calculated with antenna position at center.	Calculated with CCRP at center.
BCR, BCT		Calculated from bow position.	
Own ship data	Heading	Data is taken from respective sensors, regardless of reference point selected.	
	Speed		
	Course over ground		
	Speed over ground		
	Own L/L	Location of the CCRP.	

Note: When the antenna is located some distance from the CCRP, the CCRP can be outside the bearing cursor in true motion or off-center. Also, when the CCRP is set as reference point, some parts of the bearing cursor are not displayed.

1.49 Anchor Watch

The anchor watch feature alerts you when your ship has traveled a distance greater than a threshold value, when it should be at rest. When the anchor watch is active, an orange dashed circle marks the anchor watch range.

If your ship goes outside the circle, the warning "ANCHOR WATCH" appears in the [ALERT] box.

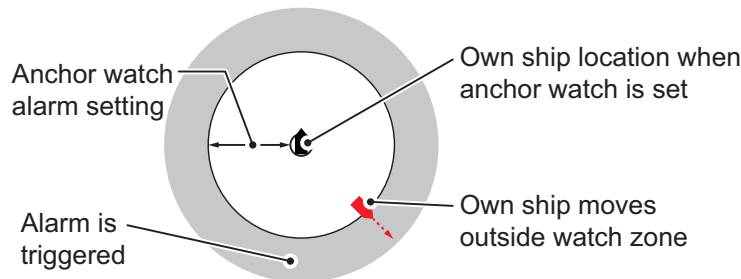

1. Open the [MAIN MENU].
2. Select [ALERT], then push the **ADJUST** knob.
3. Select [ANCHOR WATCH], then push the **ADJUST** knob.
4. Select [ON] to enable [ANCHOR WATCH].
5. Using the **ADJUST** knob, set the distance for the alert. Push the **ADJUST** knob to apply the setting.
6. Close the menu.

1.50 Alerts

1.50.1 What is an Alert?

"Alert" is a generic name for a notice to any unusual or potentially dangerous situation generated within the system.

Alerts output by this equipment are classified as per MSC.302/6.2.x (excerpts below).

Alerts are classified according to priority and category.

Alert priority

There are three alert priorities: alarm, warning and caution.

Alarm: Situations or conditions which require immediate attention, decision and (if necessary) action by the bridge team to avoid any kind of hazardous situation and to maintain the safe navigation of the ship.

Warning: Situations or conditions which require immediate attention for precautionary reasons, to make the bridge team aware of conditions which are not immediately hazardous, but may become so.

Caution: Awareness of a condition which continues to require attention out of the ordinary consideration of the situation or of given information.

Note: All active-unacknowledged warnings are repeated as warnings after 60 seconds (manufacturer's fixed time period).

Alert category

An alert is further classified by category, A, B or C, according to its degree of severity or source.

Category	Description
A	Category A alerts include the following, and must be confirmed from the equipment that generated the alert. <ul style="list-style-type: none"> • Danger of collision
B	Category B alerts are alerts where no additional information for decision support is necessary. Category B alerts are all alerts not falling under category A.
C	Category C alerts are not shown on this equipment.

Note 1: This equipment does not provide the functional alert group function.

Note 2: The reserved cluster identifier for this equipment, which is defined in IEC62923-2 is “Nav”.

1.50.2 How to Interpret the ALERT Box

When an alert condition is found, the applicable alert message appears in the [ALERT] box. A buzzer sounds for alarm and warning alerts. When there are no active alerts or indications, the message "NO ACTIVE ALERTS" appears in the [ALERT] box.

The [ALERT] box is composed of the following information, which appears in the locations shown in the below figure.

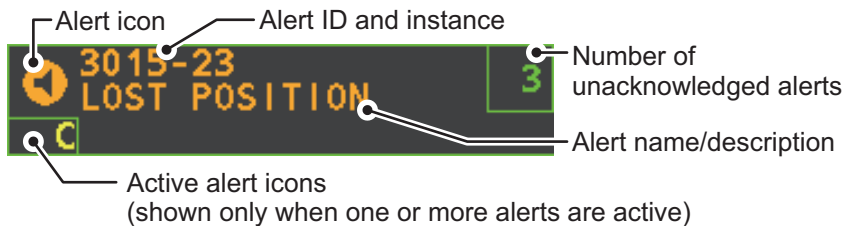

The alert icon shows the level of the alert (alarm, caution, warning or indication) and the active alert counter shows how many alerts are unacknowledged.

Status indications are displayed in yellow text. The displayable indications are listed in the table below.

Status indication	Reason for display
AUTO VIDEO ADJ	Video adjust ([VIDEO ADJ]) is set to [AUTO].
PM	Performance Monitor (PM) is ON.
SART	SART is ON.
TUNE INITIALIZE	TUNE INITIALIZE is ON.
VIRTUAL AIS ATON:OFF	[AIS VIRTUAL ATON] is OFF.
WR CARD DATA	Writing data to SD-card.
RD CARD DATA	Reading data from SD-card.
DELETE CARD DATA	Deleting data from SD-card.

1.50.3 How to acknowledge an alert

To acknowledge an alert, do one of the following:

- Press the **ALERT ACK** key.
- Place the cursor on the alert name in the [ALERT] box, then press the **left button**.
- Place the cursor on the alert name in the [ALERT LIST], then press the **left button**.

1.50.4 How to silence the alert buzzer

The alert buzzer can be silenced temporarily either from the menu, or by pressing the assigned function key. To assign a function key, see section 1.9. The alert icon for silenced alerts changes as shown in section 1.50.6.

To silence the buzzer from the menu, do the following:

1. Open the [MAIN MENU].
2. Select [ALERT], then push the **ADJUST** knob.
3. Select [BUZZER STOP], then push the **ADJUST** knob.
4. Close the menu.

1.50.5 Alert list

The [ALERT LIST] displays the details for released alerts, including the time and date at which the alert was released. Up to 100 alerts are stored in the internal memory. Unacknowledged alarms are displayed first in the list (in red text), in the order in which they appear in the [ALERT] box. Unacknowledged warnings are displayed in the list (in yellow-orange text), in the order in which they appear in the [ALERT] box.

Cautions are displayed in the list (in yellow text), in the order in which they appear in the [ALERT] box.

Indications are displayed with a yellow “i” surrounded with a yellow box.

An unacknowledged alert can be acknowledged from the list by selecting it, then pressing the **left button**. To erase the data for the number selected, press the **left button** again.

To display the [ALERT LIST], place the cursor in the [ALERT] box and press the **right button**.

Displayed page/Pages available

The screenshot shows the 'ALERT LIST(1/2)' screen with the following content:

```

[ALERT LIST(1/2)]
1 BACK(L=TOP)
2 3015-23
  LOST POSITION
  NO.1 RADAR
  28/SEP/2020 06:36
3 3015-27
  LOST COG/SOG SIG
  NO.1 RADAR
  28/SEP/2020 06:36
4 3015-20
  LOST GYRO SIGNAL
  NO.1 RADAR
  28/SEP/2020 06:36
5 3016-26
  LOST AIS COM
  NO.1 RADAR
  28/SEP/2020 06:36
0 NEXT(L=LAST)
  
```

Callouts and their descriptions:

- 1 BACK(L=TOP)**:
 - When selected at page 1, closes the list.
 - When selected at page 2 or later, goes back to the previous page.
 - Long-press the **left button** to go to page 1.
- 2 3015-23** (Alert details):
 - Alert icon
 - Alert number (code)
 - Alert title
 - Radar which output this alert
 - Date and time of alert*
- 0 NEXT(L=LAST)**:
 - Select to go to the next page
 - Long-press the **left button** to go to the last page.

*: The date and time of alert is synchronized with UTC, using the ZDA sentence. If the ZDA sentence is lost, the date and time cannot be synchronized with UTC.

To change pages, select [NEXT], then press the **left button**.

Detailed alert information

To view detailed information for an alert, open the alert list, place the cursor on the alert you want to view detailed information for, then press and hold the **left button**.

The screenshot shows the 'ALERT DETAIL DATA' screen with the following content:













```

[ALERT DETAIL DATA]
1 BACK
ID 3015-23
TITLE
  LOST POSITION
STATUS
  ACTIVE -
  UNACKNOWLEDGED
PRIORITY
  WARNING
CATEGORY B
TIME 06:37 28/SEP
SOURCE NO.1 RADAR
DESCRIPTION
  CHECK POSITION SENSOR OR
  SENTENCE MONITOR
9 REFRESH DATA
  
```

Callouts and their descriptions:

- 1 BACK**: Select to go back to the alert list.
- ID 3015-23**: Alert ID and instance
- TITLE LOST POSITION**: Alert title
- STATUS ACTIVE - UNACKNOWLEDGED**: Alert status
- PRIORITY WARNING**: Alert priority and category
- TIME 06:37 28/SEP**: Date and time of occurrence
- SOURCE NO.1 RADAR**: Radar which output the alert
- DESCRIPTION CHECK POSITION SENSOR OR SENTENCE MONITOR**: Alert details
- 9 REFRESH DATA**: Select to go refresh the displayed information.

1.50.6 Alert icons and their meanings

Icon	Status	Visual indication	Audible alert
	Active - unacknowledged alarm	Red, flashing	3 short, audible alerts repeated every 7 seconds.
	Active - silenced alarm	Red, flashing	Silent
	Active - acknowledged alarm	Red	Silent
	Active - responsibility transferred alarm	Red	Silent
	Active - responsibility transferred alarm	Red	Silent
	Active - unacknowledged warning	Yellow-orange, flashing	2 short, audible alerts repeated every 60 seconds.
	Active - silenced warning	Yellow-orange, flashing	Silent
	Active - acknowledged warning	Yellow-orange	Silent
	Active - responsibility transferred warning	Yellow-orange	Silent
	Rectified - unacknowledged warning	Yellow-orange	Silent
	Caution	Yellow	Silent
	Indication	Yellow	Silent

1.50.7 Responsibility Transfer Alert

MSC302(87) requires the use of the "responsibility transfer alert" which functions in the multiple sensor, multiple equipment installation. When one sensor or one equipment fails but does not disturb the system operation (other sensor or equipment is normal), the AMS automatically sends the "responsibility transfer alert" (ACN sentence) to the sensor or equipment that generated the alert.

If the sensor or equipment refuses the responsibility transfer, normal operation is restored.

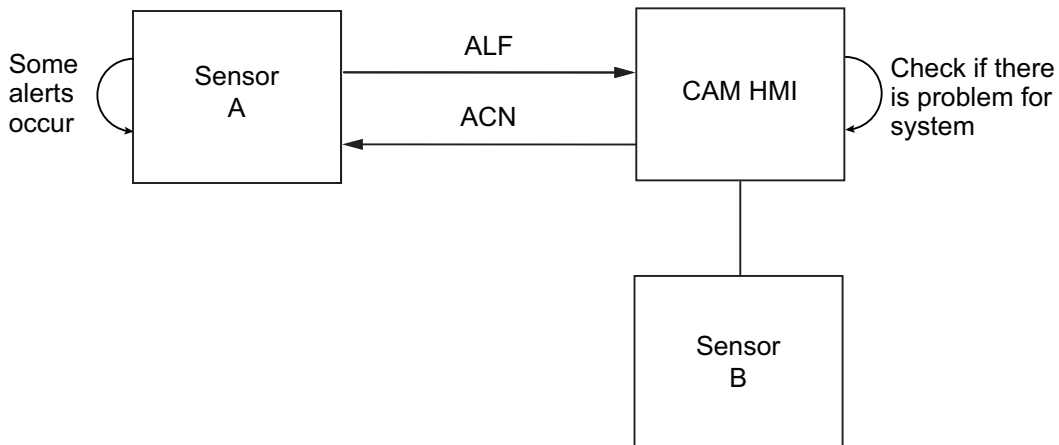

If the HBT sentence is not received from the AMS within the prescribed time interval, the alert processed as responsibility transfer alert is made active.

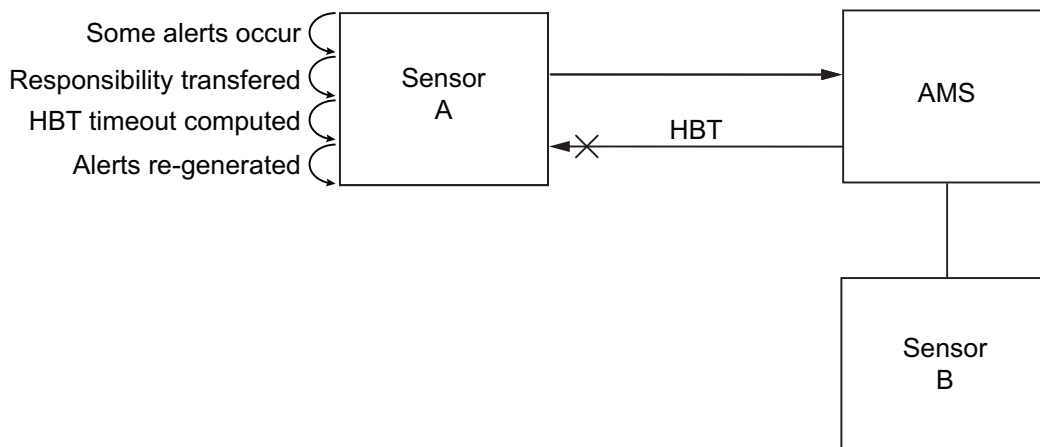

1.50.8 How to adjust the alert sound level

1. Open the [MAIN MENU].
2. Select [ALERT], then push the **ADJUST** knob.
3. Select [ALERT SOUND LEVEL], then push the **ADJUST** knob.
4. Select [OFF], [LOW], [MID] or [HIGH] as appropriate, then push the **ADJUST** knob.
 - Note 1:** This setting is applied to all alerts output from this radar system.
 - Note 2:** The [OFF] setting is not available on IMO-type radars.
5. Close the menu.

1.51 How to Select a Display Mode (For Non-IMO types Only)

Non-IMO type radars of this series have two display modes available:

- Standard display mode: The operational display area, box functions, data display, etc. are shown in a standard (IMO compliant) manner.
- Simple display: The display is echo-focused.

Follow the procedure below to change display modes.

1. Open the [MAIN MENU].
2. Select [ECHO], then push the **ADJUST** knob. The [ECHO] menu appears.
3. Select [ECHO AREA], then push the **ADJUST** knob.
4. Select the appropriate setting, then push the **ADJUST** knob.

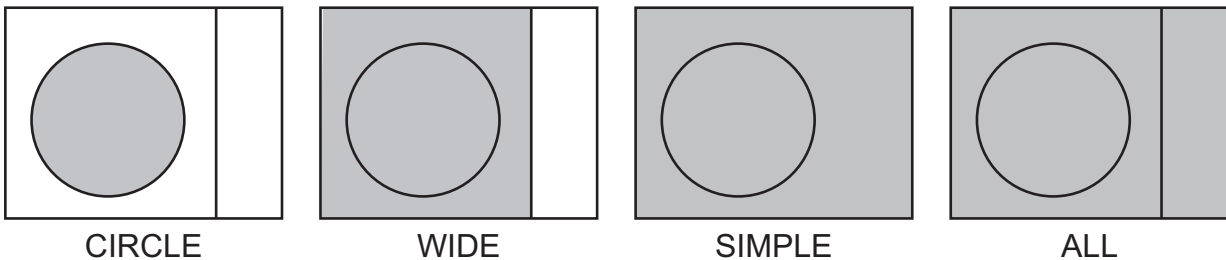

- [CIRCLE] mode: The echoes are displayed inside a circle on the screen.
 - [WIDE] mode: The echoes are displayed in a square area, but are not displayed in the data display area.
 - [SIMPLE] mode: The display is echo-focused, menu boxes and the data display are simplified.
 - [ALL] mode: The echoes are displayed across the entire screen.
5. Close the menu.

1.52 How to Manage SD-Card Data

The following data can be stored on a SD-Card: marks, lines, user settings, installation settings, own track, alert history and some alert logs (for example, the alert log).

1.52.1 How to access the SD-Card menu

Note: This operation is only available when a SD-Card is inserted. When there is no SD-Card inserted, the [FILES] menu is not selectable.

1. Open the [MAIN MENU].
2. Select [FILES], then push the **ADJUST** knob.
3. Select [DRIVE SELECT], then push the **ADJUST** knob.
4. Select [SD-1] or [SD-2] as appropriate, then push the **ADJUST** knob.

1.52.2 How to save data

1. Access the SD-Card menu as shown in subsection 1.52.1
2. Using the **ADJUST** knob, select [SAVE DATA], then push the **ADJUST** knob.
3. Using the **ADJUST** knob, select the data to save, then push the **ADJUST** knob. The software keyboard appears.
4. Using the software keyboard, name the file, then select [END] to start saving data. The file name can be up to 12 characters in length. The indication "WR CARD DATA" appears during the save process.
5. Close the menu.

1.52.3 How to read (load) data

Note: Make sure you delete all existing own ship track data before you load track data from the SD-Card.

1. Access the SD-Card menu as shown in subsection 1.52.1
2. Using the **ADJUST** knob, select [REPLAY (READ) DATA], then push the **ADJUST** knob.
3. Using the **ADJUST** knob, select the data to read, then push the **ADJUST** knob. The indication "RD CARD DATA" appears during the read process.
4. Close the menu.

1.52.4 How to delete data

1. Access the SD-Card menu as shown in subsection 1.52.1
2. Using the **ADJUST** knob, select [DELETE DATA], then push the **ADJUST** knob.
3. Using the **ADJUST** knob, select the data to delete, then push the **ADJUST** knob. The indication "DELETE CARD DATA" appears during the delete process.
4. Close the menu.

1. OPERATIONAL OVERVIEW

This page is intentionally left blank.

2. RADAR OBSERVATION

2.1 General

2.1.1 Minimum and maximum ranges

Minimum range

The minimum range is defined by the shortest distance at which, using a scale of 1.5 or 0.75 nm, a target having an echoing area of 10 m² is still shown separate from the point representing the antenna position.

It is mainly dependent on the pulselength, antenna height, and signal processing such as main bang reduction and digital quantization. It is a good practice to use a shorter range scale as far as it gives favorable definition or clarity of picture.

The IMO Resolution MSC.192(79) requires the minimum range to be less than 40 m, respectively. This series of radars satisfy this requirement.

Maximum range

The maximum detecting range of the radar, R_{max}, varies considerably depending on several factors such as the height of the antenna above the waterline, the height of the target above the sea, the size, shape and material of the target, and the atmospheric conditions.

Under normal atmospheric conditions, the maximum range is equal to the radar horizon or a little shorter. The radar horizon is longer than the optical one by about 6% because of the diffraction property of the radar signal. The R_{max} is given in the following equation.

$$R_{\max} = 2.2 \times (\sqrt{h_1} + \sqrt{h_2})$$

where R_{max}: radar horizon (nautical miles)

h₁: antenna height (m)

h₂: target height (m)

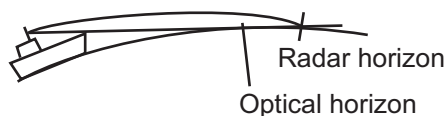

For example, if the height of the antenna above the waterline is 9 meters and the height of the target is 16 meters, the maximum radar range is;

$$R_{\max} = 2.2 \times (\sqrt{9} + \sqrt{16}) = 2.2 \times (3 + 4) = 15.4 \text{ nm}$$

It should be noted that the detection range is reduced by precipitation (which absorbs the radar signal).

2. RADAR OBSERVATION

X-band and S-band

In fair weather, the equation on the previous page does not give a significant difference between X- and S-band radars. However, in heavy precipitation condition, an S-band radar would have better detection than an X-band radar.

Radar resolution

There are two important factors in radar resolution (discrimination): bearing resolution and range resolution.

- Bearing resolution is the ability of the radar to display as separate pips the echoes received from two targets that are at the same range and close together. It is proportional to the antenna length and reciprocally proportional to the wavelength. The length of the antenna radiator should be selected for a bearing resolution better than 2.5° (IMO Resolution). This condition is normally satisfied with a radiator of 1.2 m (4 ft) or longer in the X-band. The S-band radar requires a radiator of about 12 feet (3.6 m) or longer.

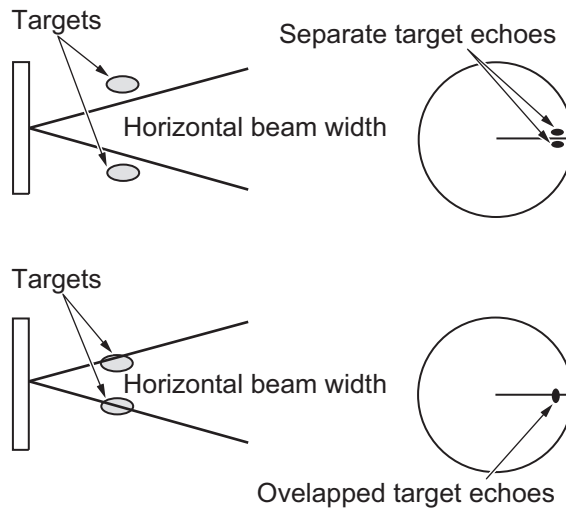

- Range resolution is the ability to display as separate pips the echoes received from two targets that are on the same bearing and close to each other. This is determined by pulse length only. Practically, a 0.08 microsecond pulse offers the discrimination better than 40 m as do so with all FURUNO radars.

Test targets for determining the range and bearing resolution are radar reflectors having an echoing area of 10 m^2 .

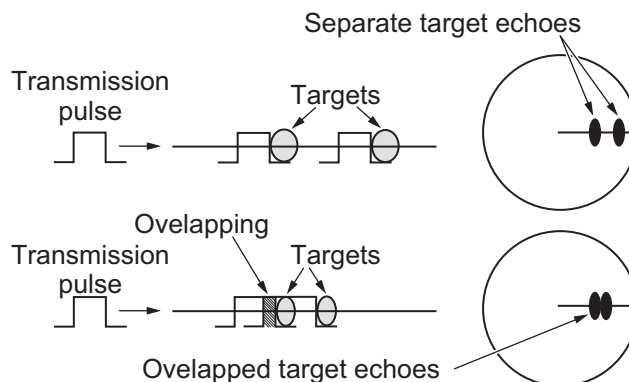

Bearing accuracy

One of the most important features of the radar is how accurately the bearing of a target can be measured. The accuracy of bearing measurement basically depends on the narrowness of the radar beam. However, the bearing is usually taken relative to the ship's heading, and thus, proper adjustment of the heading line at installation is an important factor in ensuring bearing accuracy. To minimize error when measuring the bearing of a target, put the target echo at the extreme position on the screen by selecting a suitable range.

Range measurement

Measurement of the range to a target is also a very important function of the radar. Generally, there are two means of measuring range: the fixed range rings and the variable range marker (VRM). The fixed range rings appear on the screen with a predetermined interval and provide a rough estimate of the range to a target. The variable range marker's diameter is increased or decreased so that the marker touches the inner edge of the target, allowing the operator to obtain more accurate range measurements.

2.2 False Echoes

Occasionally echo signals appear on the screen at positions where there is no target or disappear even if there are targets. They are, however, recognized if you understand the reason why they are displayed. Typical false echoes are shown below.

Multiple echoes

Multiple echoes occur when a transmitted pulse returns from a solid object like a large ship, bridge, or breakwater. A second, a third or more echoes may be observed on the display at double, triple or other multiples of the actual range of the target as shown below. Multiple reflection echoes can be reduced and often removed by decreasing the gain (sensitivity) or properly adjusting the A/C SEA control.

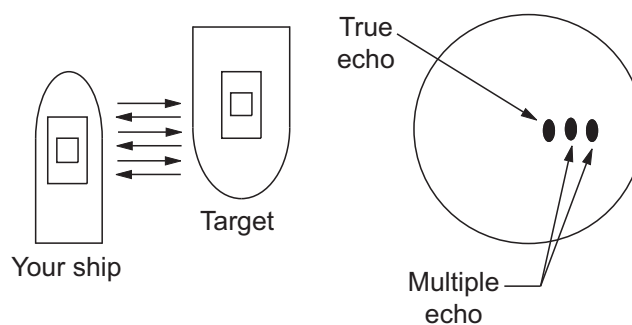

2. RADAR OBSERVATION

Sidelobe echoes

Every time the radar pulse is transmitted, some radiation escapes on each side of the beam, called "sidelobes". If a target exists where it can be detected by the side lobes as well as the main lobe, the side echoes may be represented on both sides of the true echo at the same range. Side lobes show usually only on short ranges and from strong targets. They can be reduced through careful reduction of the gain or proper adjustment of the A/C SEA control.

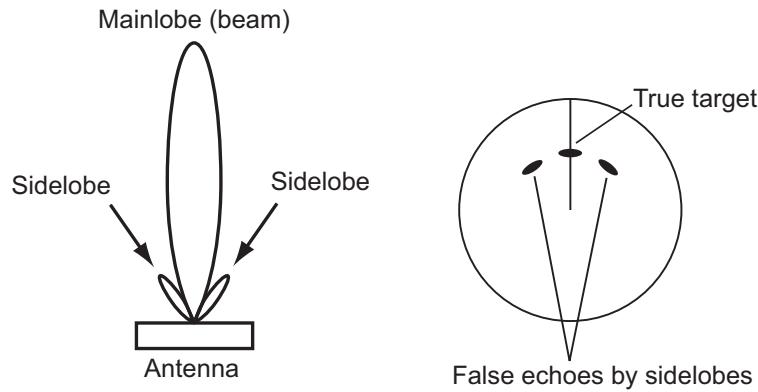

Virtual image

A relatively large target close to your ship may be represented at two positions on the screen. One of them is the true echo directly reflected by the target and the other is a false echo which is caused by the mirror effect of a large object on or close to your ship as shown in the figure below. If your ship comes close to a large metal bridge, for example, such a false echo may temporarily be seen on the screen.

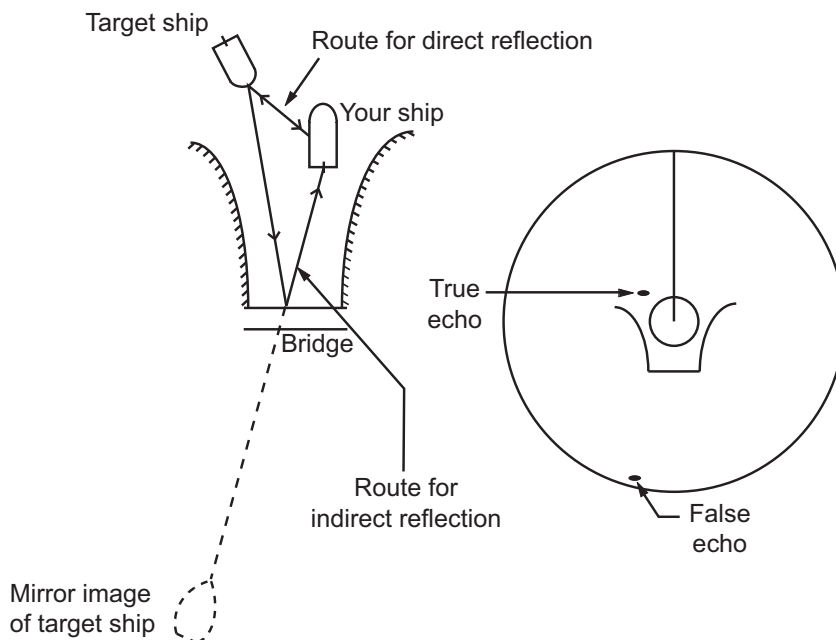

Shadow sectors

Funnels, stacks, masts, or derricks in the path of the antenna block the radar beam. If the angle subtended at the antenna is more than a few degrees, a non-detecting sector may be produced. Within this sector targets can not be detected.

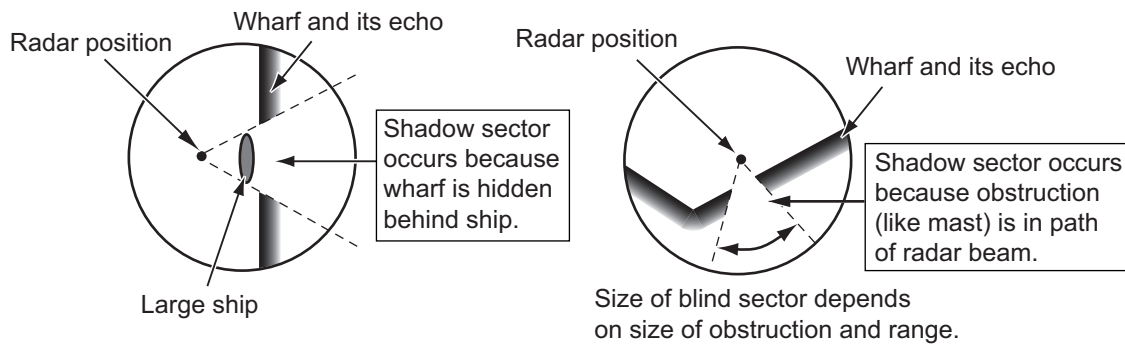

2.3 SART (Search and Rescue Transponder)

2.3.1 SART description

A Search and Rescue Transponder (SART) can be triggered by any X-Band (3 cm) radar within a range of approximately 8 nm. Each radar pulse received causes it to transmit a response which is swept repetitively across the complete radar frequency band. When interrogated, it first sweeps rapidly (0.4 μ s) through the band before beginning a relatively slow sweep (7.5 μ s) through the band back to the starting frequency. This process is repeated for a total of twelve complete cycles. At some point in each sweep, the SART frequency will match that of the interrogating radar and be within the pass band of the radar receiver. If the SART is within range, the frequency match during each of the 12 slow sweeps will produce a response on the radar display, thus a line of 12 dots equally spaced by about 0.64 nautical miles will be shown.

When the radar to the SART is reduced to about 1 nm, the radar display may show also the 12 responses generated during the fast sweeps. These additional dot responses, which also are equally spaced by 0.64 nautical miles, will be interspersed with the original line of 12 dots. They will appear slightly weaker and smaller than the original dots.

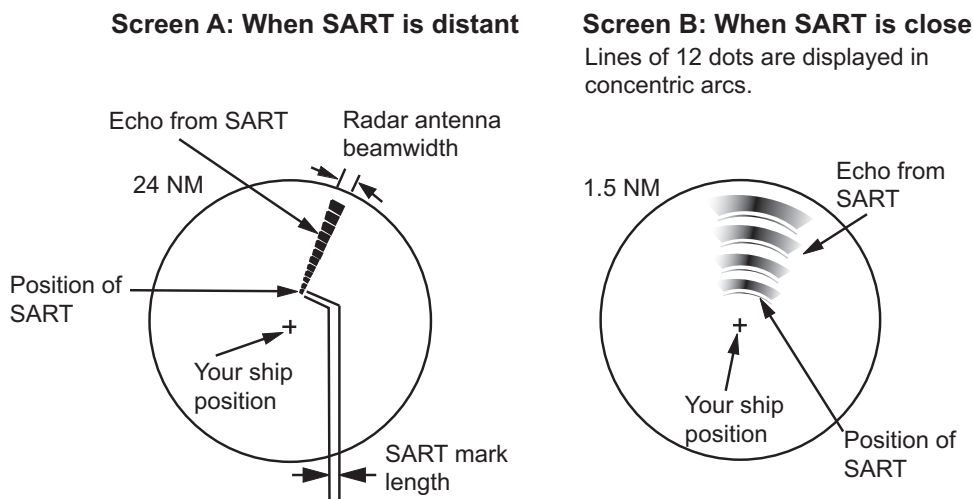

2.3.2 How to show SART marks on the radar display

This radar is equipped with a feature that optimally sets up the radar for SART detection. This feature automatically detunes the radar receiver out of its best tuning condition. This erases or weakens all normal radar echoes, but the SART marks are not erased because the SART response signal scans over all frequencies in the 9 GHz band. When the radar approaches the SART in operation, the SART marks will enlarge to large arcs, blurring a large part of the screen.

1. Open the [MAIN MENU].
2. Select [ECHO], then press the **left button**.
3. Select [SART], then press the **left button**.
4. Select [ON] to show SART marks on the radar display, then press the **left button**. Select [OFF] to hide SART marks.

When the SART function is active, the settings listed in the table on the following page are automatically made to radar functions:

Setting	Changed to
Range	12 NM
Pulselength	Long
Echo Stretch	Off
Noise Rejector	Off
Echo Averaging	Off
Interference Rejector	Off
Performance Monitor	Off
A/C RAIN	Off

5. Close the menu.

The indication "SART" appears at the bottom of the alert box, in yellow text, when this feature is active. Be sure to turn this feature off when SART detection is no longer your objective.

2.3.3 General remarks on receiving SARTs

SART range errors

When responses from only the 12 low frequency sweeps are visible (when the SART is at a range greater than about 1 nm), the position at which the first dot is displayed can be as much as 0.64 nm beyond the true position of the SART. When the range closes so that the fast sweep responses are seen also, the first of these will be no more than 150 meters beyond the true position.

Radar bandwidth

This is normally matched to the radar pulselength and is usually switched with the range scale and the associated pulselength. Narrow bandwidths of 3-5 MHz are used with long pulses on long range scales and wide bandwidths of 10-25 MHz with short pulses on short ranges.

A radar bandwidth of less than 5 MHz will attenuate the SART signal slightly, so it is preferable to use a medium bandwidth to ensure optimum detection of the SART.

Radar sidelobes

As the SART is approached, sidelobes from the radar antenna can show the SART responses as a series of arcs or concentric rings. These can be removed by the use of the anti-clutter sea control although it can be operationally useful to observe the side lobes as they may be easier to detect in clutter conditions and also they will confirm that the SART is near to own ship.

Note: SART information excerpted from IMO SN/Circ 197 OPERATION OF MARINE RADAR FOR SART DETECTION.

2.4 RACON

A RACON is a radar beacon that emits radar receivable signals in the radar frequency spectrum (X- or S-band). There are several signal formats; in general, the RACON signal appears on the radar screen as a rectangular echo originating at a point just beyond the position of the radar beacon. It has a Morse coded pattern. Note that the position on the radar display is not accurate.



Echoes on the radar screen

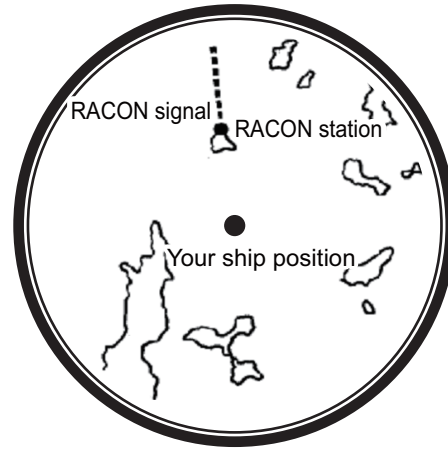

Echo description

2.5 Radar Target Enhancer (RTE)

An RTE is a radar transponder mounted on navigation buoys and masts of small crafts to significantly improve their detection by radar. Unlike a SART or RACON, which are passive, the RTE receives a radar signal, amplifies it and re-transmits it, with the intention of making the target's signal look larger on a radar display. The RTE is available in X-band and S-band types.

3. TARGET TRACKING (TT)

3.1 Precautions for Target Tracking Usage



WARNING

No one navigational aid should be relied upon for the safety of vessel and crew. The navigator has the responsibility to check all aids available to confirm position. Electronic aids are not a substitute for basic navigational principles and common sense.

- ◆ This TT automatically tracks automatically or manually acquired radar targets and calculates their courses and speeds, indicating them by vectors. Since the data generated by the auto plotter are based on what radar targets are selected, the radar must always be optimally tuned for use with the auto plotter, to ensure required targets will not be lost or unwanted targets such as sea returns and noise will not be acquired and tracked.
- ◆ A target does not always mean a land-mass, reef, ships or other surface vessels but can imply returns from sea surface and clutter. As the level of clutter changes with environment, the operator should properly adjust the [A/C SEA], [A/C RAIN] and [GAIN] controls to be sure target echoes are not eliminated from the radar screen.



CAUTION

The plotting accuracy and response of this TT meets IMO standards. Tracking accuracy is affected by the following:

- ◆ Tracking accuracy is affected by course change. One to two minutes is required to restore vectors to full accuracy after an abrupt course change. (The actual amount depends on gyrocompass specifications.)
- ◆ The amount of tracking delay is inversely proportional to the relative speed of the target. Delay is on the order of 15 - 30 seconds for high relative speed; 30 - 60 seconds for low relative speed.
- ◆ The target tracking and pertinent vector calculation accuracy is influenced by the following:
 - Echo intensity
 - The range measurement accuracy; characterized by both random and biased measurement errors.
 - The angular measurement accuracy; characterized by beam shape, target glint and bias errors.
 - Radar transmission pulsewidth
 - Gyrocompass heading error
 - Speed log error
 - Current and wind (set & drift)
 - Course change (own ship and target)

The data generated by TT, AIS and video plotter are intended for reference only.

Refer to official nautical charts for detailed and up-to-date information.

3.2 TT Controls

The control unit has two keys that are used in the target tracking mode. The keys are indicated in the figure below.

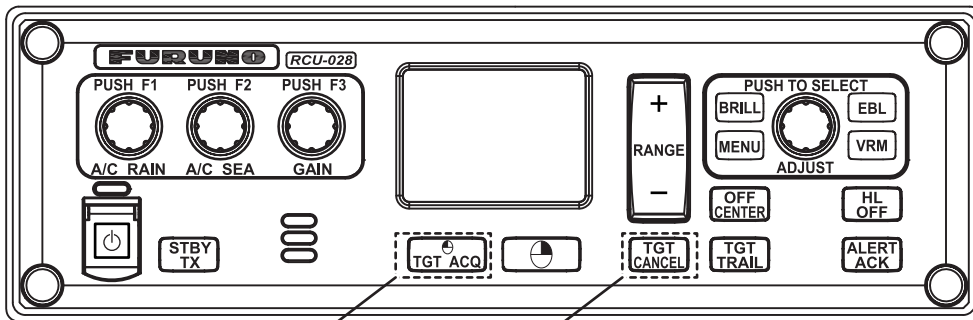

Manual target acquisition Cancel target

- **TGT ACQ:** Acquires the selected echo as a target.
- **TGT CANCEL:** Deactivates tracking for the cursor-selected target.

These functions, along with other TT functions, can also be accessed from the [CURSOR] menu (See section 1.7).

3.3 TT Box Overview

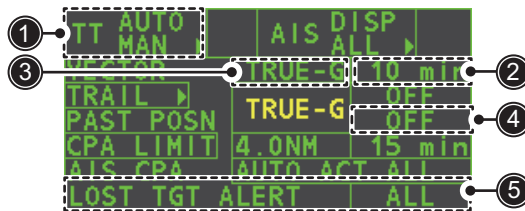

No.	Indication name	Description/remarks
1	TT acquisition mode	Shows current TT mode (AUTO, AUTO/MAN, MAN).
2	Vector time	Adjusts the vector time for the selected target.
3	Vector reference	True, Relative referencing for this target's vector.
4	Past position time	Sets the interval for the target's trail.
5	Lost TGT Alert	Displays/hides the alert when a target is lost.

3.4 How to Select the TT Mode

Target tracking is available in three modes: [MANUAL 50] (up to 50 targets, selected manually), [MANUAL 25•AUTO 25] (up to 50 targets, 25 selected automatically, 25 selected manually) and [AUTO 50] (up to 50 targets, selected automatically). To select a target tracking mode, do the following:

1. Select the [TT] box, then press the **right button**.
The [TT TARGET MENU] appears.
2. Select [TT SELECT], then push the **ADJUST** knob.
3. Select the appropriate mode, then push the **ADJUST** knob.
4. Close the menu.

3.5 How to Acquire and Track Targets

Place the cursor on the TT acquisition mode indicator, then press the **left button**. The indication changes, depending on the TT mode selected (See section 3.4). The table below shows the indication changes based on mode selection.

TT mode selected	Indication change
[Manual 50]	"OFF" → "MAN" → "OFF"...
[MANUAL 25•AUTO 25]	"OFF" → "MAN/AUTO" → "OFF"...
[AUTO 50]	"OFF" → "AUTO" → "OFF"...

The plotting symbol is drawn by broken lines during the initial acquisition stage. A vector appears in about one minute after acquisition indicating the target's motion trend. If the target is consistently detected for three minutes, the plotting symbol changes to a solid circle. If acquisition fails, the target plotting symbol blinks and disappears shortly.

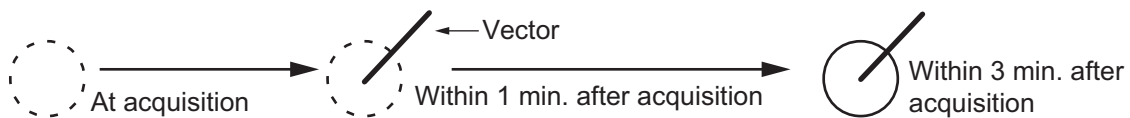

3.5.1 How to manually acquire targets

You can acquire targets manually using one of the following two methods:

Using the control unit (RCU-028)

1. Place the cursor on the target to acquire.
2. Press the **TGT ACQ** key.

Using the menu

1. Select the operational display area, then press the **right button**. The [CURSOR] menu is displayed.
2. Select [TARGET DATA/ACQ], then push the **ADJUST** knob.
3. Place the cursor on the target to acquire, then push the **ADJUST** knob.

Note 1: For successful acquisition, the target to be acquired should be within 0.1 to 24 nm (or 32 nm, depending on initial setting) from own ship and not obscured by sea or rain clutter.

Note 2: When the capacity for manual acquisition is reached, the message "TT TGT FULL(MAN)" appears at the screen bottom. Cancel tracking of non-threatening targets if you wish to acquire additional targets manually.

Note 3: When a target being tracked nears another target being tracked, the targets may be "swapped". When two targets acquired either automatically or manually come close to each other, one of the two may become a Lost Target. Should this happen, manual re-acquisition of the Lost Target may be required after the two have separated.

3. TARGET TRACKING (TT)

3.5.2 How to automatically acquire targets

Targets are automatically acquired when the TT mode is set to either [MANUAL 25•AUTO 25] or [AUTO 50] and a target enters the acquisition zone (see section 3.15). The maximum tracking distance (24 NM or 32 NM) is set at installation.

3.6 How to Enter Own Ship Speed

The TT requires own ship's speed and heading data. The speed can be STW, SOG or echo-referenced speed (based on 3 max. stationary objects). Manual input is also possible. For automatic or manual input, see section 1.12. For echo-referenced speed input follow the procedure below.

3.6.1 Echo-referenced speed input

The use of echo-referenced speed is recommended when:

- The speed log is not operating properly or not connected to the radar.
- The vessel has no device (doppler sonar, speed log, etc.) that can measure ship's bow-stern, port-starboard movement.

If you select echo-referenced speed, the TT calculates own ship's speed relative to a fixed reference target. The number of targets may be R1, R2 or R3. When a plural of objects are selected, the mean value is used, for stabilization and speed.

1. Select the operational display area, then press the **right button**. The [CURSOR] menu appears.
2. Select [REF MARK], then push the **ADJUST** knob. The cursor is highlighted.
3. Place the cursor on the location to be used as a reference, then push the **ADJUST** knob. The cursor changes from the highlighted cross to a circle with dashed lines, indicating that the reference location is now set. See section 3.9 for more information on TT symbols and their attributes.

The dashed lines of the reference point change to a solid line over time, as shown in the figure above.

Notes on speed input by reference target

- Reference targets are only used for the calculation of true speed.
- Do not use reference target generated true speed to calculate relative speed. Relative speed data is not accurate because response to speed change is slow, hampering the TT's ability to accurately judge the possibility of collision.
- Select a stationary target as a reference target to calculate own ship speed as ground tracking speed. Do not choose a moving target as a reference target. A moving target produces error in the vector for TT and AIS, which results in wrong collision avoidance information. Further, an unstable stationary target produces inaccurate speed data and the target itself may become lost.
- When a reference target is lost or goes out of the acquisition range, that reference target mark blinks and the indication "REF TARGET LOST" appears in the alert box. If all reference targets are lost, the speed indication reads "*.*" Select a different reference target if currently selected one is lost.

- When all targets are deleted, the reference target mark is also deleted and the target-based speed becomes invalid. The speed is indicated as "BTREF" where BT means Bottom Track (speed over ground).
- Reference targets can be marked with a vector.
This can be done with [REF TARGET VECTOR] on the [TT TARGET] menu.
- Loss of reference target will affect the calculation of true speed and true course of targets. Further, own ship speed will be inaccurate.

How to cancel echo-referenced speed input

1. Open the [MAIN MENU].
2. Select [SHIP SPEED MENU], then push the **ADJUST** knob.
3. Select [SHIP SPEED], then push the **ADJUST** knob.
4. Select any option other than [REF], then push the **ADJUST** knob.
5. Close the menu.

3.7 How to Cancel Target Tracking

When the number of tracked targets reaches maximum capacity, the alert box shows [TT TGT FULL (MAN)] or [TT TGT FULL (AUTO)], based on the selected TT mode. No new targets can be acquired until a tracked target is lost or tracking is canceled. When this occurs, cancel tracking for non-dangerous targets as required.

3.7.1 How to cancel tracking for individual TT targets

Using the control unit (RCU-028)

1. Select the tracked target to cancel.
2. Press the **TGT CANCEL** key.

Using the CURSOR menu

Note: This methods requires [TGT CANCEL SETTING] in the [CURSOR MENU] to be set as [ANY] or [TT ONLY].

1. Select the operational display area, then press the **right button**. The [CURSOR] menu appears.
2. Select [TARGET CANCEL], then push the **ADJUST** knob.
3. Select the tracked target to cancel, then press the **left button**.
4. Press the **right button** to complete the procedure.

3. TARGET TRACKING (TT)

3.7.2 How to cancel tracking for all TT targets

Using the control unit (RCU-028)

Press and hold the **TGT CANCEL** key.

Using the menu

1. Select the TT mode indication in the [TT•AIS] box at the right-side of the screen, then press the right button. The [TT TARGET MENU] appears.
2. Select [ALL CANCEL], then push the **ADJUST** knob.
3. Select [YES], then push the **ADJUST** knob to cancel tracking for all TT targets.
4. Close the menu.

3.8 Lost Target

Targets not detected in five consecutive scans become “lost targets”. A lost target is shown in the display with a flashing red “X”. Flashing stops after the lost target alert is acknowledged.

If you are in an area where tracked targets are lost frequently, you may want to disable the lost target alert against tracked targets, by maximum range or minimum speed.

3.8.1 How to set the lost target filter

You can set the lost target alert to sound against lost targets that are within a specific range. To set the criteria, use the procedure below.

1. Open the [MAIN MENU].
2. Select [TT•AIS], then push the **ADJUST** knob.
3. Select [TT LOST FILTER], then push the **ADJUST** knob.
4. Select [MAX RANGE], then push the **ADJUST** knob.
5. Select [ON], then push the **ADJUST** knob. The settings can now be adjusted.
6. Rotate the **ADJUST** knob to adjust the setting as required, then push the **ADJUST** knob to apply the setting.
7. Close the menu.

Note: Reference targets are not affected by this filter.

3.8.2 How to enable/disable the lost target alert

The [LOST TARGET ALERT] box at the bottom right corner enables and disables the lost target alert. Select the box with the cursor, then push the **left button** to select [OFF], [ALL] or [FILT] as appropriate.

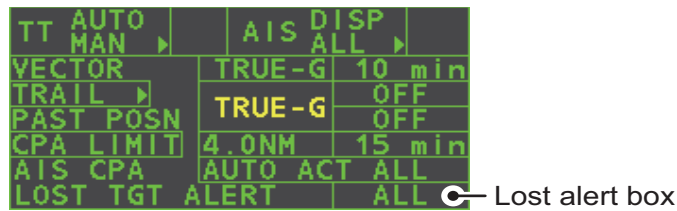

- [OFF]: Disable the alert.
- [ALL]: Enable the alert for all lost targets, including filtered targets.
- [FILT]: Enable the alert for all lost targets, excluding filtered targets.

Note: The filter setting is applied to both TT and AIS lost objects

3.9 TT Symbols and Attributes

3.9.1 TT symbols

Item	Symbol	Status	Remarks
Automatically acquired target symbols shown.		Initial stage	Broken circle around an echo to indicate that the target is under acquisition and initial stage of tracking, before steady-state tracking.
For manually acquired targets, the width of the line for "steady tracking" TT is thicker than that of the automatically acquired targets.			Within one minute after acquisition (vector still unreliable).
		Steady tracking	Solid circle with vector indicating steady state tracking (within three minutes after acquisition.)
		CPA alarm	Plotting symbol (red) flashes to indicate the target is predicted to come into CPA or TCPA.
		CPA alarm acknowledge Lost target	Shown in red, and flashing stops after CPA/TCPA alarm is acknowledged. A red "X" is crossed through the TT symbol to indicate that it is a lost target. Flashing stops after lost target is acknowledged.
Acquisition zone		On target passing through operator-set acquisition zone	Symbol is red and flashing.
Target selected for data readout		On selected target	Target data (range, bearing, course, speed, CPA, TCPA, BCR, BCT, etc.) displayed in information box.
Reference target	 After three minutes, changes to 	On reference target	Used to calculate own ship's over-the-ground speed (echo-referenced speed) for ground stabilization.

3. TARGET TRACKING (TT)

3.9.2 How to adjust symbol brilliance

1. Place the cursor on the [BRILL] box, then press the **right button**. The [BRILL] menu appears.
2. Select [TT SYMBOL], then push the **ADJUST** knob. The settings can now be adjusted.
3. Rotate the **ADJUST** knob to select the desired brilliance, then push the **ADJUST** knob to apply the setting.
4. Close the menu.

3.9.3 How to set the symbol color

1. Open the [MAIN MENU].
2. Select [TT•AIS], then push the **ADJUST** knob.
3. Select [TT•AIS SYMBOL], then push the **ADJUST** knob.
4. Select [SYMBOL COLOR], then push the **ADJUST** knob. The settings can now be adjusted.
5. Select the appropriate color, then push the **ADJUST** knob.
6. Close the menu.

3.10 How to Display/Remove Target Data

The TT mode provides the full functionality of TT as required by the IMO Resolution A.823(19) and IEC 62288, including display of range, bearing, course, speed, CPA and TCPA of all tracked targets.

The target bearing is shown in relative bearing in the HEAD UP mode and true bearing in the COURSE UP, NORTH UP and True Motion modes, with the suffix "R" (Relative) or "T" (True).

The target speed and course are shown as speed over the ground or speed through the water depending on speed source.

3.10.1 How to display target data

Place the cursor on a desired tracked target and press the **TGT ACQ** key. The target's shape changes to a square and the selected TT target's data is shown in the data display area.

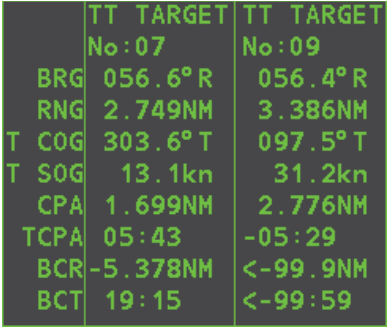
Indication	Description	
BRG	Bearing from own ship to target in relative (R) or True (T) reference.	
RNG	Range from own ship to target.	
T COG	Relative (R) or True (T) Course Over Ground of target. Displayed as "T CTW" where speed input is set to [LOG(WT)]. Displayed as "R CRS" where speed data is not available.	
T SOG	Relative (R) or True (T) Speed Over Ground of target. Displayed as T STW where speed input is set to [LOG(WT)]. Displayed as R SPD where speed data is not available.	
CPA	Closest Point of Approach of target to own ship.	
TCPA	Time to CPA of target to own ship.	
BCR	Bow crossing range of target.	
BCT	Bow crossing time of target.	

You can display the target data for two targets in one data box and the data for as many as six targets can be displayed.

3.10.2 How to remove target data

Place the cursor on a desired tracked target and press the **TGT CANCEL** key. The select target's data is removed from the data display area.

3. TARGET TRACKING (TT)

3.10.3 How to display, hide and sort the target list

The target list provides a comprehensive data display of all TT (and AIS) targets being tracked.

How to display/hide the target list

1. Select the [Target List] menu item at the bottom-right of the screen, then press the **left button**. The target list appears inside the information box.
2. Select the [Target List] menu item at the bottom-right of the screen, then press the **left button** to hide the target list.

How to sort the target list

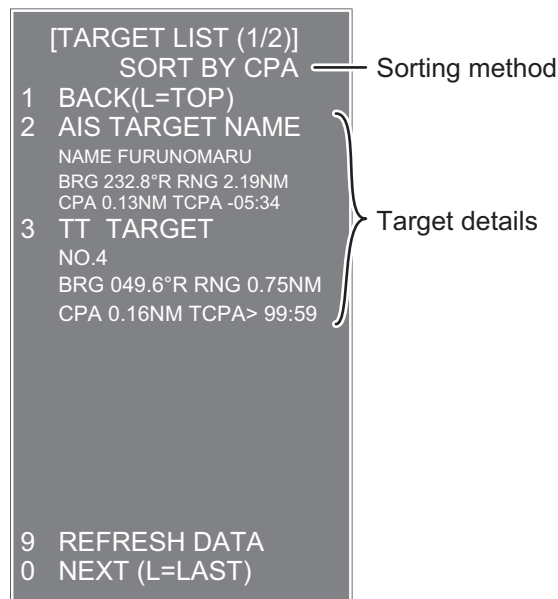

1. With the target list displayed, select [Sort by], then push the **ADJUST** knob.
2. Select the sort method, referring to the table below, then push the **ADJUST** knob.

Sort method	Description
[CPA]	Targets are sorted in order from closest to farthest CPA.
[TCPA]	Targets are sorted in order from shortest to longest TCPA.
[BCR]	Targets are sorted in order from closest to farthest BCR.
[BCT]	Targets are sorted in order from shortest to longest BCT.
[RANGE]	Targets are sorted in order from closest to farthest range.
[SPEED]	Targets are sorted in order from fastest to slowest.
[NAME]	Targets are sorted in Alphabetical order. Unknown names are displayed last.

3. Select the appropriate filter option, if required, then push the **ADJUST** knob.

Note: Targets with no data are sorted to the back of the list, regardless of filter setting.

3.10.4 How to use the target name feature (Non-IMO only)

You can assign a name to TT targets which you want to visually separate from other TT targets. The assigned name appears next to the target in the operational display area and replaces the target number. The name also appears in the target information and target list, when the named target is selected.

The target name is retained unless the radar is turned off, or the target is not within tracking range.

Note: This feature is not available for reference targets.

Enabling/disabling the function and setting preset names

You can assign up to ten preset names to use when naming a TT target.

1. Open the [MAIN MENU].
2. Select [TT•AIS], then push the **ADJUST** knob.
3. Select [TT], then push the **ADJUST** knob.
4. Select [TARGET NAME FUNCTION], then push the **ADJUST** knob.

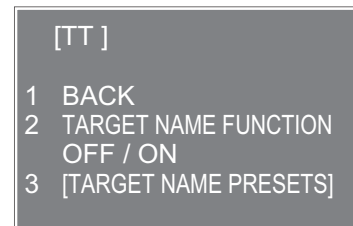

5. Select the appropriate option, then push the **ADJUST** knob.

[ON]: enables the function and allows preset names to be changed.

[OFF]: disables the function and related menu features are not selectable.

If you selected [ON], go to the next step in this procedure. If you selected [OFF], close the menu.

6. Select [TARGET NAME PRESETS], then press the **ADJUST** knob.
7. Select the preset number whose name you want to change, then push the **ADJUST** knob. The software keyboard appears.
8. Using the software keyboard, name the preset, then select [END].
9. Repeat steps 5 and 6 as required to rename other presets.

Note: Preset numbers with no name assigned will appear as a blank item in the name selection window when you select a target. Blank presets are not selectable as a target name.
10. Close the menu.

How to assign a name to a target

Note: The following procedure requires the [TARGET NAME FUNCTION] menu item to be set as [ON].

1. Select the TT target you want to assign a name to, then press the **left button**. The target information appears in the data display area.
2. Select the target data in the data display area, then press the **left button**. The [TARGET NAME] window appears.
3. To assign a preset name to the target, select the preset from the [PRESET LIST]. To assign a specific name to the target, select [TARGET NAME], then go to the next step in this procedure.
4. Using the software keyboard, assign a name to the selected target, then select [END].

3.11 Vector Modes

Target vectors can be displayed relative to own ship's heading (Relative) or North (True).

Note: IMO recommends the use of true vector mode in sea stabilization or relative vector mode for collision avoidance.

To change the vector mode, do the following:

Place the cursor on the vector reference indication in the [Vector] box, then press the **left button**. The vector reference cycles through the following settings with each press of the **left button**.

[REL] → [TRUE-G/TRUE-S] → [REL]...

3.11.1 Description of vectors

Stabilization modes

It is important to select the optimum stabilization mode for the radar display. To assess risk of collision the relative motion of a target gives the clearest indication of CPA and may be monitored by observing either the direction of the target's relative trail, or the CPA predicted by the relative vector. By default, relative motion displays relative target trails and true motion displays true target trails. Where true target trails is selected, a sea stabilized display will indicate all targets' motion through the water. A ground stabilized display will indicate all targets' motion over the ground.

In coastal, estuarine and river waters where a significant set and drift may be experienced, a sea stabilized display will produce significant target trails from all fixed (stationary) objects possibly producing an unacceptably high level of clutter and masking. In such circumstances a ground stabilized display may reduce its effect and enable the observer to detect clearly the trails of moving targets, thus enhancing the observer's situational awareness.

However, the display should be considered only as an approximation of the course and speed made good over the ground. Among other factors, the accuracy of the ground-stabilization is affected by inaccuracies in speed and heading inputs as well as radar measurement imprecision and will require the display to be readjusted periodically. The information displayed should be interpreted with due regard to these factors.

Note: It should be noted that in determining a target's aspect by radar; the calculation of its true track is dependent on the choice and accuracy of the own ship's course and speed input. A ground-stabilized target plot may accurately calculate the ground track of the target, but the target's heading may be significantly different from its track when experiencing set, drift or leeway. Similarly, a sea stabilized target plot may be inaccurate when own ship and the target, are experiencing different rates of set, drift or leeway.

Ground stabilization and sea stabilization

Target vectors can be ground stabilized or sea stabilized in the True Motion mode. To select speed over the ground or speed through the water data, open the page from the menu. Select for ground stabilization or for sea stabilization. The vector mode indication shows the stabilization mode in the true motion as [TRUE-G] or [TRUE-S].

Sea stabilization is a mode where own ship and all targets are referenced to the sea using a compass heading and single-axis log water speed inputs in the true motion mode. Ground stabilization is a mode where own ship and all targets are referenced to the ground using the ground track or set and drift inputs. If the accuracy seems unsatisfactory, enter set and drift corrections. Note that set and drift should not be used when the radar is displaying AIS targets.

True vector

In the true motion mode, all fixed targets such as land, navigational marks and ships at anchor remain stationary on the radar screen with vector length zero. But in the presence of wind and/or current, the vectors appear on fixed targets representing the reciprocal of set and drift affecting own ship unless set and drift values are properly entered.

In the true vector mode, there are two types of stabilization: ground stabilization (TRUE-G) and sea stabilization (TRUE-S). The stabilization mode is automatically selected according to speed selection, as shown in the table below. Manual selection is available from the [SPD] menu at the top-right of the screen.

Speed selection	True vector mode
LOG(WT)	TRUE-S
LOG(WTC)	TRUE-G
LOG(BT)	TRUE-G
GPS(BT)	TRUE-G
REF(BT)	TRUE-G
MAN(WT)	TRUE-S
MAN(WTC)	TRUE-G

Relative vector

Relative vectors on targets that are not moving over the ground such as land, navigational marks and ships at anchor will represent the reciprocal of own ship's ground track. A target whose vector passes through own ship is on a collision course. (Dotted lines in the figure are for explanation only.)

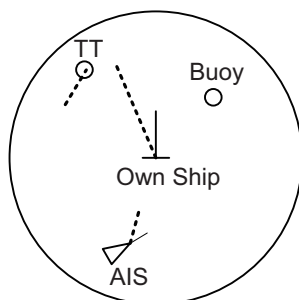

True vectors in ground stabilization

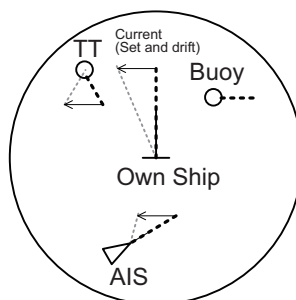

True vectors in sea stabilization

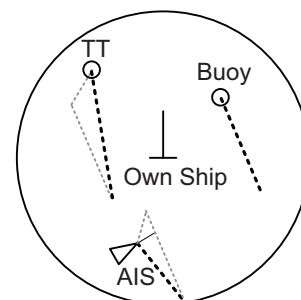

Relative vectors

3. TARGET TRACKING (TT)

3.11.2 How to change the vector length (time)

The vector time provides an estimation of the target's vector and can be adjusted as follows:

Place the cursor on the vector time indication in the [Vector] box, then press the **left button**. The vector time cycles through the following settings with each press of the **left button**.

[6min] → [10min] → [20min] → [30min] → [45min] → [60min] → [30sec] → [1min] → [3min] → [5min] → [6min]...

The vector tip shows an estimated position of the target after the selected vector time elapses. It can be valuable to extend the vector length to evaluate the risk of collision with any target.

3.12 Past Position Display

The past position display shows equally time-spaced dots marking the past positions of any targets being tracked.

A new dot is added every minute (or at other preset time intervals) until the preset number is reached. If a target changes its speed, the spacing will be uneven. If it changes the course, its plotted course will not be a straight line.

Past position orientation, true or relative, is controlled with [TRAIL MODE] in the [TRAIL] context menu. To adjust the trail orientation, see subsection 1.36.1.

3.12.1 How to display past position points and select the past position plotting interval

Place the cursor on the [PAST POSN] time indication in the [PAST POSN] box, then press the **left button**. The past position points are displayed and their plotting interval changes with each press of the **left button**, as shown below.

[OFF] → [30sec] → [1min] → [2min] → [3min] → [6min] → [OFF]...

3.12.2 How to select the number of past position points to be displayed

1. Open the [MAIN MENU].
2. Select [TT•AIS], then push the **ADJUST** knob.
3. Select [TT•AIS SYMBOL], then push the **ADJUST** knob.
4. Select [TT•AIS PAST POSN POINTS], then push the **ADJUST** knob.
5. Select [5] or [10] as appropriate, then press the **ADJUST** knob.
6. Close the menu.

3.13 Set and Drift

Set, the direction in which a water current flows, can be manually entered in 0.1-degree steps. Drift, also known as "Rate", or the speed of the current, can also be entered manually in 0.1-knot steps.

When course through water and speed through water are available, activate set and drift to get course over ground and speed over ground.

Set and drift corrections are beneficial for increasing the accuracy of vectors and target data. Refer to the tide table on board the ship for setting information. These values are applied to all targets. If stationary targets have vectors, set and drift values should be adjusted until they lose vectors.

To enter set and drift do the following:

1. Select the [SPD] menu box, then press the **right button**. The [SHIP SPEED MENU] appears.
2. Select [SET DRIFT], then push the **ADJUST** knob.
3. Select [ON], then push the **ADJUST** knob. The setting can now be adjusted and [SET] is selected.
4. Rotate the **ADJUST** knob to select the appropriate setting (Setting range: 000.0° to 359.9°), then push the **ADJUST** knob. The [DRIFT] setting is now selected.
5. Rotate the **ADJUST** knob to select the appropriate setting (Setting range: 00.0kn to 19.9kn), then push the **ADJUST** knob.
6. Close the menu.

Note 1: Set and drift are available when using manually input speed, speed through the water. The speed source is shown as "WTC" (Water Tracking Count).

Note 2: Set and drift should be checked periodically for correctness.

Note 3: When speed data input from the position sensor is valid, set and drift are not adjustable.

3.14 CPA/TCPA Alarm

This radar calculates CPA and TCPA by using own ship and relative target positions.

The TT continuously monitors the predicted range at the Closest Point of Approach (CPA) and predicted time to CPA (TCPA) of each TT. When the predicted CPA of any TT becomes smaller than a preset CPA range and its predicted TCPA less than a preset TCPA limit, the audio alarm sounds and "CPA/TCPA" appears (in red) in the Alert Box. In addition, the symbol of the offending TT is red and flashes together with its vector.

CAUTION

CPA/TCPA Alarm

The CPA and TCPA alarm feature should never be relied upon as the sole means for detecting the risk of collision. The navigator is not relieved of the responsibility to keep visual lookout for avoiding collisions, whether or not the radar or other plotting aid is in use.

This feature, when used correctly, helps prevent the risk of collision by alerting you to threatening targets. It is important that GAIN, A/C SEA, A/C RAIN and other radar controls are properly adjusted.

CPA and TCPA ranges must be set up properly taking into consideration the size, tonnage, speed, turning performance and other characteristics of own ship.

The reference point for CPA and TCPA calculation can be selected from antenna position or conning position. For further details, see section 1.48.

3.14.1 How to set the CPA and TCPA ranges

CPA and TCPA ranges can be adjusted from the appropriate indication in the [TT] box.

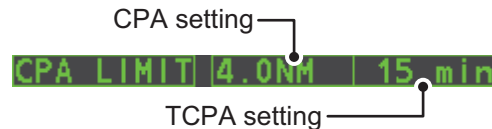

1. Place the cursor on the indication you wish to adjust.
2. Press the **left button**, or rotate the **ADJUST** knob, to adjust the settings as required. The settings options are outlined in the table below.

Indication	Key	Settings options
CPA	Left button	0.5, 1, 1.5, 2, 3, 4, 5, 6 (nm)
	ADJUST knob	0.1-20 (nm), 0-10 nm in 0.1 nm increments, 10 nm increments thereafter
TCPA	Left button	1, 2, 3, 4, 5, 6, 12, 15 (minutes)
	ADJUST knob	1-60 minutes, 1-minute increments

3.14.2 How to acknowledge the TT CPA/TCPA alarm

Press the **ALERT ACK** key on the control unit, or select the [ALERT] box with the Touchpad then press the **left button** to acknowledge the alarm and silence the buzzer. The alert "CPA/TCPA" and the flashing of the plotting symbol and vector remain in the Alert Box until the dangerous situation is gone or you intentionally terminate tracking of the target.

Note that when the CPA/TCPA alarm is generated the AIS display is automatically turned on.

3.15 Acquisition Zone

The acquisition zone functions both to alert you targets in a specific area and acts as an automatic acquisition area when automatic target acquisition is active. Any targets entering the zone will be automatically acquired.

When a target enters an acquisition zone, the buzzer sounds and the indication "TT NEW TARGET" (or "AIS NEW TARGET") appears (in yellow-orange) in the Alert Box. The symbol of the offending target is red and flashing. Further, the AIS display is automatically turned on if it is off.

There are two types of acquisition zones available, arc and polygon, however, AZ1 can only be set as an arc.

Note: The [AZ1] and [AZ2] boxes are not displayed when the setting for [AZ/ALR SELECT] in the [TT•AIS] menu is set to [TARGET ALARM ZONE].

3.15.1 How to activate the first acquisition zone (AZ1)

The No. 1 acquisition zone is available between 3 and 6 nm. The TT/AIS acquisition zone's lines are white and dashed so as to distinguish them from the radar target alarm.

The procedure below shows how to set AZ1, using the example at the bottom of the page.

1. Place the cursor on the [AZ] indication at the bottom-right of the screen.
2. Press the **left button** to cycle through the settings and select [SET].
3. Place the cursor on the acquisition zone starting point ("A" in the figure below), then press the **left button**.
4. Place the cursor on the acquisition zone end point ("B" in the figure below), then press the **left button**.
5. Press the **right button** to complete the acquisition zone set up.

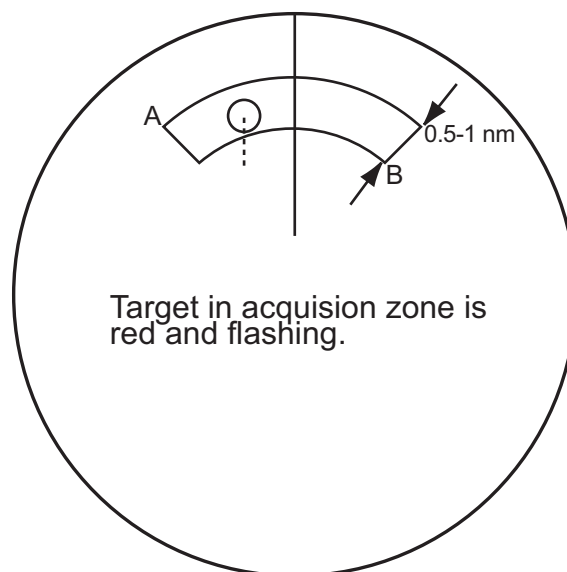

3.15.2 How to set a polygon acquisition zone (AZ2)

The No. 2 acquisition zone can be set anywhere when the No. 1 zone is already in use. Polygon zones must have at least three points.

To set a polygon shaped acquisition zone:

1. Place the cursor on the [AZ] indication at the bottom-right of the screen.
2. Press the **left button** to cycle through the settings and select [SET].
3. Place the cursor on the acquisition zone starting point, then press the **left button**.
4. Place the cursor on the second point, then press the **left button**.
5. Repeat step 4 as required to set the remaining points of the polygon zone.
6. Press the **right button** to complete the acquisition zone set up.

Notes on acquisition zones

- If you wish to create an acquisition zone having a 360-degree coverage around own ship, set point B in almost the same direction (approx. $\pm 3^\circ$) as point A, then press the left button.
- The default acquisition zone is fan shaped. It can also be a polygon having 3-10 points.
- If both acquisition zones are displayed, a maximum of four polygon points are shown.
- TT and AIS are automatically set to TT=AUTO and AIS=DISP, respectively, when an AZ is activated in the following conditions:

TT : TT=OFF or TT=MANUAL 50

AIS : AIS FUNC=OFF or AIS DISP=OFF

3.15.3 How to sleep/deactivate an acquisition zone

1. Select the appropriate [AZ] box.
2. Sleep, or deactivate, the acquisition zone, as explained below:

Sleeping the acquisition zone

Press the **left button** several times until the indication shows "SLEEP".

Deactivating the acquisition zone

Press and hold the **left button** until the AZ box becomes blank.

Note: When both [AZ1] and [AZ2] are active, [AZ2] must be deactivated before [AZ1] can be deactivated.

If [AZ1] and [AZ2] are active when you try to deactivate [AZ1], the system releases an audible alert and shows the message "DELETE AZ2 FIRST".

3.15.4 How to acknowledge the acquisition zone alert

Press the **ALERT ACK** key on the control unit, or select the [ALERT] box with the Touchpad then press the **left button** to acknowledge the alarm and silence the buzzer.

3.15.5 How to change the acquisition zone reference

The acquisition zone can be referenced to heading or North using the following procedure:

1. Open the [MAIN MENU].
2. Select [TT•AIS], then push the **ADJUST** knob.
3. Select [ACQUISITION ZONE], then push the **ADJUST** knob.
4. Select [AZ STAB], then push the **ADJUST** knob.
5. Select [STAB HDG] to reference heading, or [STAB NORTH] to reference North.
6. Close the menu.

3.15.6 How to set acquisition zone shape and stabilization

The shape of the No. 2 acquisition zone can be a sector or a polygon having up to 10 points. (The shape of the No.1 acquisition zone is always a sector.)

1. Open the [MAIN MENU].
2. Select [TT•AIS], then push the **ADJUST** knob.
3. Select [ACQUISITION ZONE], then push the **ADJUST** knob.
4. Select [AZ POLYGON], then push the **ADJUST** knob.
5. Select the appropriate setting, then push the **ADJUST** knob.

Setting	Description
[OFF]	Acquisition zone is a sector; number of points is limited to four. Stabilized against land.
[STAB GND]	Polygon having 3-10 points. Stabilized against ground.
[STAB HDG]	Polygon having 3-10 points. Stabilized against heading.
[STAB NORTH]	Polygon having 3-10 points. Stabilized against North.

6. Close the menu.

3.16 TT System Messages

There are four main reasons the TT may trigger the audio and visual alerts:

- Collision alarm
- Acquisition zone alert
- Lost target alert
- Target capacity

To acknowledge the alert, press the **ALERT ACK** key on the control unit, or select the [ALERT] box with the Touchpad then press the **left button** to acknowledge the alert and silence the buzzer.

Alert message	Priority	Meaning	Action required
CPA/TCPA	Alarm	A tracked target is on collision course with your vessel.	Take evasive action or terminate tracking of TT.
TT NEW TARGET	Warning	Tracked target has entered an acquisition zone. The tracked target's symbol is red and flashing.	Confirm the tracked target, then press the ALERT ACK key.
TT TARGET LOST	Warning	When the system detects a loss of a tracked target, the lost tracked target symbol appears in red and flashes. At the same time, an audio alert is produced for one second. The lost target mark disappears from the screen after the lost target alert is acknowledged.	Confirm the lost target, re-acquire if necessary.
REF TARGET LOST	Warning	When the system detects a loss of a reference target, the target symbol turns red and flashes. At the same time, an audio alert is produced for one second. The reference target mark disappears from the screen after the reference target alarm is acknowledged.	To continue using a referenced target for speed input, select another tracked target.
TT TGT FULL (AUTO) or (MAN)	Warning	Appears when capacity for automatically (manually) acquired targets is full.	To continue acquiring targets, cancel tracking for unnecessary targets.
TT TGT 95% (AUTO) or (MAN)	Caution	Appears when capacity for automatically (manually) tracked targets is 95% full.	

3.17 TT Simulation Mode

You can simulate the risk of a collision by using the TT simulation mode. The test can be terminated at any time by pressing the **STBY/TX** key.

1. Open the [MAIN MENU].
2. Select [INITIAL SETTING], then push the **ADJUST** knob.
3. Select [TEST], then push the **ADJUST** knob.
4. Select [TT TEST], then push the **ADJUST** knob.

The normal operation is suspended then three simulated targets appear on the display.

The indication "S" appears at the bottom of the effective display area during the simulation mode. The simulation may be terminated any time by going to the STBY mode.

Three simulated targets move as the following table. The simulated target is automatically generated with the relative movement in the following table based on own ship's movement at the start of simulation mode.

Note: If own ship moves after the start of simulation mode, the movement of the simulated target is not matched with the values in the following table.

	Range (R)	Bearing (R)	Speed (R)	Course (R)	CPA	TCPA
Target 01	9.5 NM	270.0°	20.0 kn	90.0°	0.0 NM	28.5 min
Target 02	1.1 NM	333.0°	10.2 kn	90.2°	1.0 NM	2.9 min
Target 03	9.3 NM	45.0°	19.9 kn	225.1°	0.0 NM	28.0 min

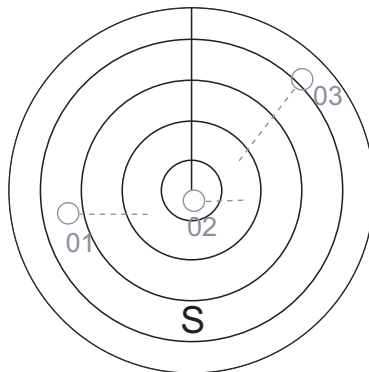

Place the cursor on a target, then press the **TGT ACQ** key to display the target data.

Acquire the simulated targets after the TT simulation mode is performed. The tracking state changes from unstable to stable and the vector appears. You can simulate the movement of each function with changing true/relative vector, stabilization through the water/over the ground, range or length of vector.

Repeat the check for all targets.

3.18 Criteria for Tracking Target Selection

The FURUNO TT video processor detects targets in midst of noise and discriminates radar echoes on the basis of their size. Target whose echo measurements are greater than those of the largest ship in range or tangential extent are usually land and are displayed only as normal radar video. All smaller ship-sized echoes that are less than this dimension, are further analyzed and regarded as ships and displayed as small circles superimposed over the video echo.

When a target is first displayed, it is shown as having zero true speed but develops a course vector as more information is collected. In accordance with the International Marine Organization Automatic Radar Plotting Aid (IMO TT) requirements, an indication of the motion trend should be available within 20 scans of antenna and full vector accuracy within 60 scans. The FURUNO TTs comply with these requirements.

Acquisition and tracking criteria

A target which is hit by five consecutive radar pulses, is detected as a radar echo. Manual acquisition is done by designating a detected echo with the trackball. Automatic acquisition is done in the acquisition areas when a target is detected 5-7 times continuously depending upon the congestion. Tracking is achieved the target is clearly distinguishable on the display for 5 out of 10 consecutive scans, whether acquired automatically or manually. Required tracking facilities are available within 0.1-32 nm on range scales including 3, 6, 12 nm, full plotting information is available within one scan when the range scale has been changed.

Targets not detected in five consecutive scans become "lost targets".

Quantization

The entire picture is converted to a digital form called "Quantized Video". A sweep range is divided into small segments and each range element is "1" if there is radar echo return above a threshold level, or "0" if there is no return.

The digital radar signal is then analyzed by a ship-sized echo discriminator. As the antenna scans, if there are five consecutive radar pulses with 1's indicating an echo presence at the exact same range, a target "start" is initiated. Since receiver noise is random, it is not three-bang correlated, and it is filtered out and not classified as an echo.

The same is true of radar interference. Electronic circuits track both the closet and most distant edges of the echo. At the end of the scanning of the echo, the discriminator indicates the measured maximum range extent and total angular extent subtended by the echo. If the echo is larger than a ship-sized echo in range extent and/or angular width, adjusted as a function of range, it is declared to be a coastline and the closet edge is put into memory as a map of the area.

This land outline is used to inhibit further acquisition and tracking of ship-sized echoes beyond the closest coast outline. Five consecutive scans of coastal outline are retained in memory to allow for signal variation. All smaller echoes are declared to be ship sized and the middle of the leading edge is used to provide precise range and bearing co-ordinates of each echo on every scan. This range/bearing data is matched to previous data and analyzed from scan-to-scan for consistency. When it is determined to be as consistent as a real target, automatic acquisition occurs and tracking is initiated. Continued tracking and subsequent calculation develop the relative course and speed of the target.

The true course and speed of own ship are computed from own ship's gyro and speed inputs, and the resulting course and speed of each tracked target is easily computed by vector summing of the relative motion with own ship's course and speed. The resulting true or relative vector is displayed for each of the tracked targets. This process is updated continually for each target on every scan of the radar.

Qualitative description of tracking error

The FURUNO TT's accuracy complies with or exceed IMO standards.

Own ship maneuvers

For slow turns there is no effect. For very high turning rates (greater than 150°/minute, depending on gyro), there is some influence on all tracked targets that lasts for a minute or two then all tracked targets revert to full accuracy.

Other ship maneuvers

Target ship courses, lag 15 to 30 seconds at high relative speed, or 3 to 6 seconds at low (near 0) relative speed. It is less accurate during a turn due to lag, but accuracy recovers quickly.

3.19 Factors Affecting TT Functions

Low gain

Insufficient or low radar receiver gain will result in some targets not being acquired at long distance. TT display will be missing on one or more targets that could only be visible if the radar sensitivity control (GAIN control) were increased.

The setting of the correct radar receiver gain is not critical but the target should be on the radar PPI and be clearly visible and well defined.

Manual acquisition is done if a target is positively displayed more than once. Automatic acquisition is done when the target is detected 5-7 times continuously. Tracking is achieved when the target is detected five times (not necessarily continuously) out of 10 scans. If not detected six times out of 10 scans, the target will become a "lost target". The TT will acquire a radar echo that is present once in every six antenna scans and continue tracking if 1 in 10.

Sea returns

If the radar anti-clutter control is adjusted properly, there is no serious effect because distant wave clutter, not eliminated by this control, is filtered out by more than one bang correlation and scan-to-scan matching of data.

Rain and snow

Clutter can be acquired and tracked as targets. Adjust the A/C RAIN control. If it is heavy rain, switch to S-band if provided, or switch on the interference rejector on the radar. If heavy clutter still exists, switch to manual acquisition. Accuracy can be affected.

Low clouds

Usually no affect. If necessary, adjust the A/C RAIN.

3. TARGET TRACKING (TT)

Non-synchronous emissions

No effect.

Second trace echoes

When the radar beam is super refracted, strong echoes may be received at such long ranges that they appear on a different timebase sweep than the transmitted pulse. This gives an incorrect range indication. Second and third trace echoes can be tracked if they are consistent enough to meet acquisition and tracking criteria but target course and speed data will be in error.

Blind and shadow sectors

Radar shadow or blind areas caused by obstructions aboard ship, for example, funnels and masts, in the path of the radar beam can result in reduction of radar beam intensity in that particular direction. This may eliminate the detection of some targets. The TT system will lose track of targets shortly after they are lost on the radar picture and if they remain in a blind zone. These targets will however be acquired and tracked when they pass out of the blind zone and again present normal radar echo. The angular width and bearing of any shadow sector should be determined for their influence on the radar. In certain cases false echoes in the shadow sector cause the TT system to acquire, track, and vector them. Shadow sectors should be avoided.

Indirect echoes

A target at close range is usually picked up directly, but it can also be received as reflection from a large, flat surface. This will result in the radar presenting two or more echoes on the display, each at a different range. The TT can acquire and track the false echo if it is detected by five consecutive scans. Reduction in radar gain can eliminate the multiple echoing but care should be taken as range detection also will be reduced.

Radar interference

If interference is extreme due to another radar operating at close range, spiral "dotting" and/or false targets may appear momentarily. The interference rejector can clear the display.

To receive radar beacon or SART signals, turn on [SART] in the [ECHO] menu.

4. AIS OPERATION

An AIS transponder can be connected to this radar to overlay AIS objects on the radar display. The maximum number of AIS objects that can be stored in storage buffer of this radar is shown in the following table. When this buffer becomes full of AIS objects, an appropriate alert is generated to alert you to full storage buffer. The storage buffer contains automatic dead reckoning for AIS targets (class A and B AIS targets and SAR vessels) and AIS SAR aircrafts, which is based on reported Speed Over the Ground (SOG), Course Over the Ground (COG), Rate Of Turn (ROT) and heading. The storage buffer also contains calculation of range, bearing, CPA, TCPA, etc.

AIS object type	Processing capacity	Alert when reaching	
		95% of processing capacity	100% of processing capacity
AIS targets			
Class A target	1000	AIS CPTY 95%	AIS CPTY FULL
Class B target		AIS CPTY 95%	AIS CPTY FULL
AIS data report			
AIS base station	40	-	AIS DATREP FULL
AIS SAR aircraft		-	AIS DATREP FULL
Physical AIS AtoN		-	AIS DATREP FULL
Virtual AIS AtoN		-	AIS DATREP FULL
Mobile Physical AIS AtoN		-	AIS DATREP FULL
Mobile Virtual AIS AtoN		-	AIS DATREP FULL
Synthetic AIS AtoN		-	AIS DATREP FULL
AIS locating device			
AIS-SART* (active)	20	-	AIS SART FULL
AIS-SART* (test)		-	AIS SART FULL
AIS synthetic target			
AIS synthetic target	40	-	AIS SYN TGT FULL

*: Includes AIS-SART, AIS MOB and EPRIB-AIS.

The following table shows the display capacity for the AIS objects. When the number of displayed AIS objects reaches the display capacity, an appropriate alert generated.

AIS object type	Display capacity	Alert when reaching	
		95% of display capacity	100% of display capacity
AIS targets			
Class A target	300	AIS DISPLAY 95%	AIS DISPLAY FULL
Class B target		AIS DISPLAY 95%	AIS DISPLAY FULL
AIS data report			
AIS base station	40	-	-
AIS SAR aircraft		-	-
Physical AIS AtoN		-	-
Virtual AIS AtoN		-	-
Mobile Physical AIS AtoN		-	-
Mobile Virtual AIS AtoN		-	-
Synthetic AIS AtoN		-	-

4. AIS OPERATION

AIS object type	Display capacity	Alert when reaching	
		95% of display capacity	100% of display capacity
AIS locating device			
AIS-SART* (active)	20	-	-
AIS-SART* (test)		-	-
AIS synthetic target			
AIS synthetic target	40	-	-

*: Includes AIS-SART, AIS MOB and EPRIB-AIS.

If a new AIS object is received after reaching the processing or display capacity, this radar processes the object as follows:

- AIS targets: When reaching the processing capacity, a new AIS is ignored. When reaching the display capacity, this radar displays a maximum number of AIS objects nearest to the own ship
- AIS data report/AIS locating device/AIS synthetic target: When reaching the processing or display capacity, a new AIS is ignored.

The reporting interval for data sent from the AIS transponder depends on the speed and course of the AIS object being tracked. The table below shows the IMO standard AIS transponder reporting interval. Based on the table below, this unit determines which AIS object is being tracked or has become lost. For a lost target, its AIS symbol disappears when the lost target alert is acknowledged.

Type of Ship	IMO nominal reporting interval	Lost object indication (reporting interval >)
Class A: Navigation status is "anchor" or "not under command" or "moored" or "aground", and SOG \leq 3kn	3 min	10 min
Class A: Navigation status is "anchor" or "not under command" or "moored" or "aground", and SOG > 3kn	10 s	50 s
Class A: 0kn \leq SOG < 14kn	10 s	50 s
Class A: 14kn \leq SOG \leq 23kn	6 s	30 s
Class A: SOG > 23kn	2 s	10 s
Class B: "CS" SOG < 2kn	3 min	10 min
Class B: "CS" SOG \geq 2kn	30 s	150 s
Class B: "SO" 0 kn \leq SOG < 2kn	3 min	10 min
Class B: "SO" 2 kn \leq SOG < 14kn	30 s	150 s
Class B: "SO" 14 kn \leq SOG \leq 23kn	15 s	75 s
Class B: "SO" SOG > 23kn	5 s	25 s
Class A and Class B: no SOG available	N/A	10 min
AIS SAR aircraft	10 s	1 min
AIS aid to navigation	3 min	18 min
AIS base station	10 s	1 min
AIS search and rescue transponder	N/A	6 min
AIS synthetic target	6 min	18 min

Note: AIS operations on IMO-types require the WGS-84 Datum. Make sure the GPS connected to the radar is set to WGS-84.

An AIS transponder “sees” all ships fitted with an AIS transponder belonging to either a Class A or Class B AIS. Additionally, the AIS transponder receives messages from ships and non-ships (AIS SAR aircraft, AIS aid to navigation, AIS base station, and AIS search and rescue transmitter).

There can be several hundreds or several thousands of AIS objects, and of those only a few will be significant for your ship. To remove unnecessary AIS targets (class A or class B AIS target and AIS SAR vessel) from the radar display, the feature "active and sleeping AIS targets" is available. The feature "active and sleeping AIS targets" is very effective for focusing on only those AIS targets that need supervision. Initially any new AIS target received by an AIS transponder is not active (=“sleeping”). Such sleeping targets are shown with a small triangle. The operator can pick any AIS target and change it from sleeping to active. Active AIS targets are shown with a large triangle with speed vector, headline, ROT indicator, etc. Further, the operator can pick active AIS targets and change their status to sleeping.

An indication of AIS targets (class A or class B AIS target and AIS SAR vessel) activated capacity limit is given well before it is reached. When 95% of 40 targets are activated, the Alert "ACTIVE AIS 95%" appears. When 40 targets are activated, the Alert "ACTIVE AIS FULL" appears.

4.1 Controls for AIS

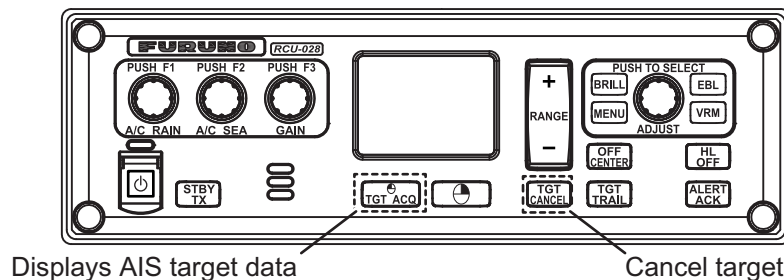

- **TGT ACQ:** Displays the selected object's data.
- **TGT CANCEL:** Sleeps the cursor-selected target.

These functions, along with other AIS functions, can also be accessed from the [CURSOR] menu (See section 1.7).

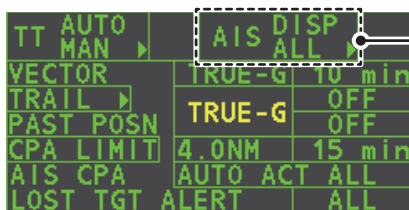

Select the AIS box, then press the **left button** to cycle through AIS display modes.

DISP OFF: Hides AIS objects

DISP FILT: Displays a filtered selection of AIS objects













DISP ALL: Displays all AIS objects







FUNC OFF: Deactivates the AIS function

4.2 AIS Symbols

AIS objects are marked with an appropriate symbol.

Object symbols

Symbol	Name	Description
	AIS target past position point	Mark past position.
	Sleeping AIS target	Sleeping AIS symbol. (Lines are thinner than Active AIS symbol.)
	Activated AIS target	Activated AIS target, with vector for course and speed. (Lines are thicker than sleeping AIS symbol.) Color can be changed with the menu.
	Activated AIS target, true scale symbol	Activated AIS target with symbol shown in true scale. Association AIS symbol or activate AIS symbol is displayed within the ship's symbol when activated. This symbol disappears when the size of the true scale symbol is smaller than 3 mm on the display.
	AIS SART	AIS SART (search and rescue radar transponder), includes AIS MOB, EPIRB-AIS
	AIS SART Test	AIS SART (search and rescue radar transponder) test.
	Selected AIS target	AIS and TT target declared as "association target". AIS symbol and AIS data are used.
	Heading - turn indicator	Target's direction of turning.
	SAR aircraft - fixed wing	SAR aircraft - fixed wing
	SAR aircraft - helicopter	SAR aircraft - helicopter
	AIS Base Station	AIS base station
	Synthetic Target	VTS generated synthetic target.
	Synthetic Target - Distress	Synthetic target in vessel distress situations.

Symbol	Name	Description
	AIS target selected	Target selected to display its data.
	SAR vessel	SAR (Search And Rescue) vessel.
	Sleeping AIS target with no CPA/TCPA data	Sleeping AIS target symbol without HDG and COG. Dashed line.
	Activated AIS target with no CPA/TCPA data	Activated AIS target symbol without HDG and COG. Dashed line.
 AIS target  AIS physical AtoN  AIS base station	Unread AIS message (Note 5)	AIS symbol with unread or viewing AIS message.

Note 1: The equipment continues to process AIS objects when the AIS feature is switched off. When the AIS is again turned on, symbols are immediately displayed.

Note 2: AIS symbols are momentarily erased after the screen is redrawn when the heading is changed from the Head-up mode.

Note 3: The alert "AIS communication lost" occurs when no AIS data is received. Check the status of the AIS transponder. Alert priority depends on state of the AIS feature.

- AIS function ON: Warning
- AIS function OFF: Caution

Note 4: The color of the AIS symbol can be changed with [TT•AIS SYMBOL] - [TT•AIS SYMBOL COLOR] in the [TT•AIS] menu.

























Note 5: [UNREAD MSG SYMBOL] ([TT•AIS menu] - [TT•AIS SYMBOL]) must be turned on to show the unread AIS message symbol.













4. AIS OPERATION

AIS AtoN symbols

The table below shows all the AIS AtoN symbols.

Note: Synthetic AtoN is described as basic shape.

AIS Physical AtoN Symbol*1	AIS Virtual AtoN Symbol	Meaning
		Basic shape
		RACON
		Emergency wreck mark
		North cardinal mark
		East cardinal mark
		South cardinal mark
		West cardinal mark
		Port hand mark
		Starboard hand mark
		Isolated danger
		Safe water
		Special mark

AIS Physical AtoN Symbol ^{*1}	AIS Virtual AtoN Symbol	Meaning
Off Posn 	— ^{*2}	Off position
Unlit 	—	Off or dimmed lighting installations
Racon err 	—	RACON error
Error 	—	Abnormal lighting installation, or AIS AtoN with abnormal lighting installation and racon installation
Missing 	— ^{*2}	Missing
		
		Self-propelled, but direction not reported or unavailable mobile AtoN
		Tethered mobile AtoN
		Mobile AtoN with COG information. Arrow mark points in course direction of COG within $\pm 22.5^\circ$ sectors.

^{*1}: A physical AtoN symbol is displayed with purpose indicator only when they are selected. See the example below.

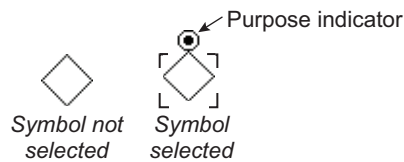

^{*2}: Unlit, “Racon err” and “Error” may be included.

4.3 How to Filter AIS Objects

If the screen becomes cluttered with AIS objects, you can filter out unnecessary AIS objects, from the [AIS DISP FILTER] menu.

1. Open the [MAIN MENU].
2. Select [TT•AIS], then press the **left button**.
3. Select [AIS DISP FILTER], then push the **left button**.
4. At [5 BASE STATION] - [7 VIRTUAL MATON] on page1 and [8 SYNTHETIC ATON] - [9 SYNTHETIC TARGET] on page 2, disable or enable tracking of respective item as appropriate. Select [ON] to filter out objects. When [6 PHYSICAL ATON] is set to [UNHEALTHY], only physical AtoN symbols with an error (“Off Posn”, “Unlit”, “Racon err”, “Error” or “Missing”) are displayed.
5. Select [2 SLEEPING TARGET MAX RANGE] and set the maximum range to display an AIS target. A sleeping AIS target not within the range set here is not displayed.
6. Set the minimum ship speed for AIS targets, with [3 SLEEPING TARGET MIN SHIP SPEED]. Any sleeping AIS target whose speed is slower than that set here will not be displayed.
7. Close the menu.
8. Place the cursor on the [AIS] box, then press the left button several times to display "DISP FILT" in the [AIS] box.

Note: This function is not available for an activated target.

4.4 How to Activate AIS Targets

When you convert a sleeping target to an activated target, that target’s course and speed are shown with a vector. You can easily judge target movement by monitoring the vector.

Sleeping targets within an acquisition zone are automatically changed to activated targets and are colored red. See section 3.15 for how to use acquisition zones.

Note: Only AIS targets (class A and B AIS targets and SAR vessels) can be activated.

4.4.1 How to activate specific targets manually

Place the cursor on the target you wish to activate for AIS tracking, then press the **left button**.

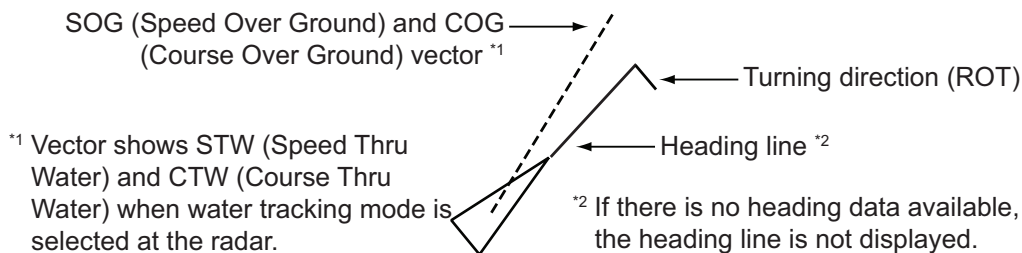

4.4.2 How to enable/disable the AIS auto activate function

Use the [CPA AUTO ACTIVATE] box at the bottom right corner to enable or disable the AIS auto activate function.

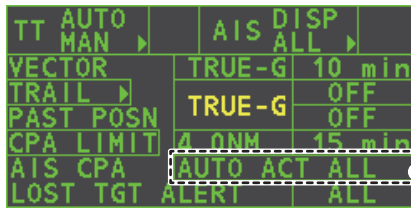

Select the AIS CPA box, then press the **left button** to cycle through AIS display modes.

1. Place the cursor on the [CPA AUTO ACTIVATE] box, then press the left button several times to display the desired auto activate function.

Filter type	Definition
[OFF]	Disable the AIS auto activate function.
[AUTO ACT ALL]	Activation against AIS targets whose CPA or TCPA is less than set in section 3.14
[AUTO ACT FILT]	Activation against AIS targets which meet the following criteria: <ul style="list-style-type: none"> • AIS target that meets the criteria set with [CPA AUTO ACTIVATE] on the [TT•AIS] menu. • CPA or TCPA of an AIS target is smaller than that set in section 3.14.

4.4.3 How to limit the functions of the AIS auto activate function

You can limit the function of the AIS auto activate function by distance from own ship, ship's speed, ship class, and ship's length.

1. Open the [MAIN MENU].
2. Select [TT•AIS], then push the **ADJUST** knob.
3. Select [CPA AUTO ACTIVATE], then push the **ADJUST** knob.
4. Referring to the table below, select the appropriate filtering type, then push the **ADJUST** knob.

Filter type	Definition
[MAX RANGE]	Any AIS objects beyond the range set here will not be automatically activated.
[MIN SHIP SPEED]	Any AIS objects slower than this setting will not be automatically activated.
[CLASS B]	Select ON to prevent activation of AIS targets class B.

5. Rotate the **ADJUST** knob to set the selected filter's options, then push the **ADJUST** knob.
6. Close the menu.

4.5 How to Sleep AIS Targets

4.5.1 How to sleep individual activated AIS targets

You can “sleep” an activated AIS target as shown below. This is useful when the screen becomes filled with targets, which might prevent important radar and AIS targets and objects from being identified.

Note 1: Dangerous targets and targets that have been activated automatically cannot be “slept”.

Note 2: Only AIS targets (class A and B AIS targets and SAR vessels) can be slept.

To sleep an individual activated AIS target, Place the cursor on the target to be slept, then press the **TGT CANCEL** key. The symbol for the slept target changes as indicated in the table in section 4.2.

4.5.2 How to sleep all activated AIS targets

1. Select the [AIS DISP] box, then press the **right button** to open the [AIS TARGET] menu.
2. Select [SLEEP ALL TGTS], then push the **ADJUST** knob.
3. Select [YES] or [NO] as appropriate, then push the **ADJUST** knob.
4. Close the menu.

Note: All activated AIS targets can also be slept, from the [CURSOR] menu (left-click the display to show), with [5 SLEEP ALL TGTS].

4.6 How to Set Up For a Voyage

At the start of a voyage, following five items must be input from the [VOYAGE DATA] menu: navigational status, ETA, destination, draught and crew.

1. Select the [AIS DISP] box, then press the **right button** to open the [AIS TARGET] menu.
2. Select [VOYAGE DATA], then push the **ADJUST** knob.
3. Select [NAV STATUS], then push the **ADJUST** knob.
4. Select the appropriate navigation status number, referring to the table below, then push the **ADJUST** knob.

Nav Status No.	Meaning
00	Underway using engine (default)
01	At anchor
02	Not under command
03	Restricted maneuverability
04	Constrained by her draft
05	Moored
06	Aground
07	Engaged in fishing
08	Under way sailing

Nav Status No.	Meaning
09	Reserved for high speed craft (HSC)
10	Reserved for wing in ground (WIG, for example, hydrofoil)
11	Power-driven vessel (ahead/astern)
12	Power-driven vessel (ahead/alongside)
13	Reserved for future use
14	SART ACTIVE
15	UNDEFINED

5. Select [ETA], then push the **ADJUST** knob.
6. Using the **ADJUST** knob, set the estimated day of the month to arrive, then push the **ADJUST** knob.

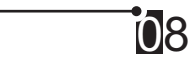
Currently selected digit is highlighted by the cursor.  08
 Rotate the **ADJUST** knob to adjust the day.
 Push the **ADJUST** knob to move to the next digit.

7. Select [DESTINATION], then press the **left button**.
8. Using the **ADJUST** knob, set the destination in alphanumeric characters, then push the **ADJUST** knob. (Max. 20 characters)

Currently selected character is highlighted by the cursor.  GOLD COAST
 Rotate the **ADJUST** knob to select the desired character.
 Push the **ADJUST** knob to move to the next character.

9. Select [DRAUGHT], then push the **ADJUST** knob.
10. Using the **ADJUST** knob, set the ship's draught, then push the **ADJUST** knob.
11. Select [CREW], then push the **ADJUST** knob.
12. Using the **ADJUST** knob, set the number of crew on-board, then push the **ADJUST** knob.
13. Close the menu.

4.7 How to Display AIS Object Data

You can display an AIS object's data by selecting it on the display, when the AIS function is set for [AIS DISP FILT].

4.7.1 Basic AIS data

Place the cursor on a desired AIS object and press the **TGT ACQ** key. The object is highlighted with a square box and the selected AIS object's data is shown in the AIS object data box in the data display area, on the right side of the screen.

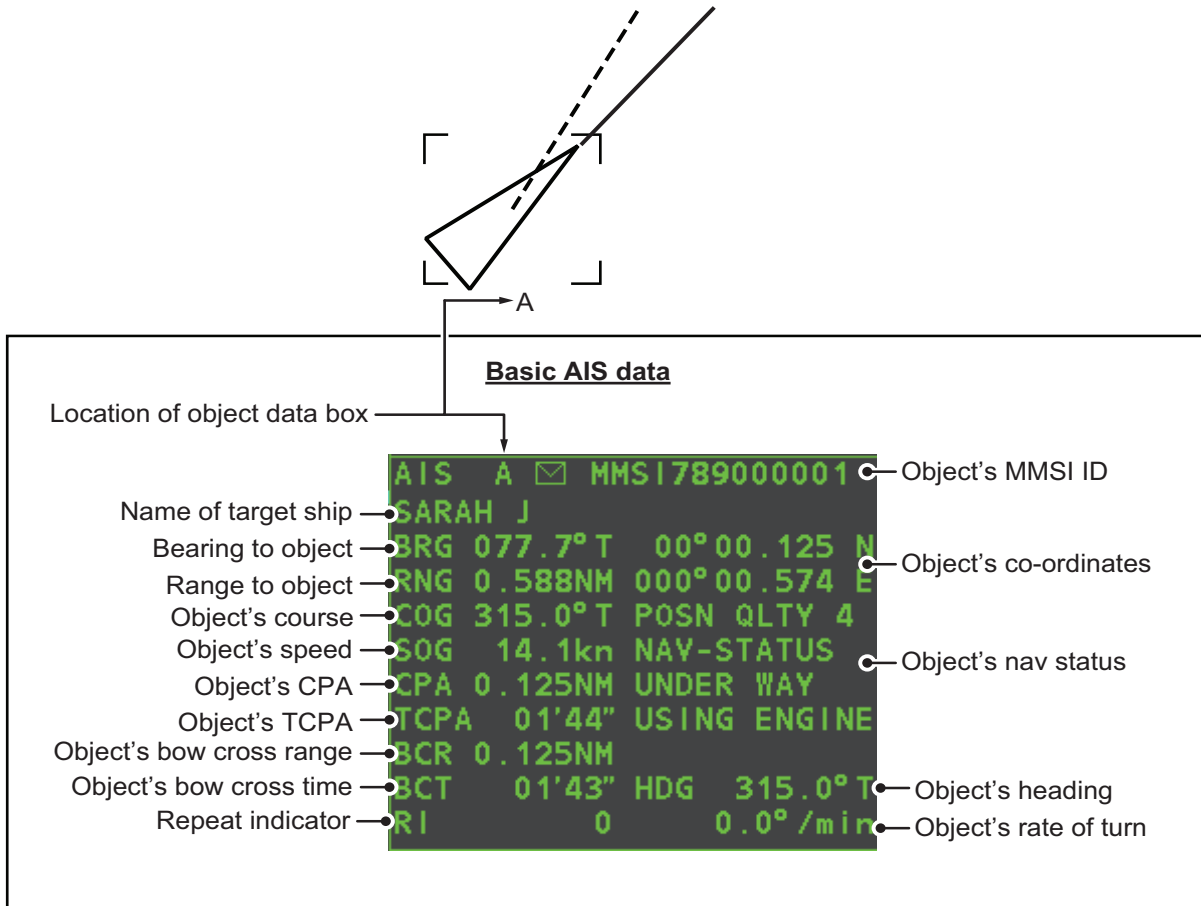

4.7.2 Expanded AIS data

To show expanded data, left click the basic AIS data display. The expanded has three pages. You can switch between pages with [0 NEXT] and [1 BACK].

[EXPANDED DATA(1/3)]

Name → NAME : SARAH J

Call sign → CALL : QAAA2

L/L position → LAT : 00° 00 .150N
LON : 000° 00 .550E

Position sensor type → POS . SENSOR : GPS

Position accuracy → POS . ACC : HIGH

RAIM status*1 → RAIM : IN USE

Course → COG : 315 .0° T

Speed → SOG : 14 .1kn

Nav status → NAV . STATUS : UNDERWAY USING ENGINE

MMSI no. → MMSI No . : 789000001

IMO no. → IMO No . : 007890001

Ship length → SHIP LENGTH : 926m

Ship width → SHIP WIDTH : 50m

Ship draft → SHIP DRAFT : 2 .0m

Destination → DESTINATION : JP UKB

Estimated time of arrival → ETA : 31/DEC 23 : 59

Transponder version*2 → CLASS A VER : 2

Association ON/OFF → ASSOCIATION : OFF

DTE availability*3 → DTE : AVAILABLE

Repeat indicator → REPEAT INDICATOR : 0

0 NEXT

Expanded Data (1/3)

[EXPANDED DATA(2/3)]

1 BACK

SHIP & CARGO TYPE : VESSEL

TOWING AND LENGTH OF THE TOW EXCEEDS 200 M OR BREADTH EXCEEDS 25 M

0 NEXT

Expanded Data (2/3)

[EXPANDED DATA(3/3)]

1 BACK

MESSAGE 1 (MOST RECENT)
28/AUG/2023 06:32
ADDRESSED SAFETY
123

MESSAGE 2
28/AUG/2023 06:31
BROADCAST SAFETY
123

Expanded Data (3/3)

*1: "RAIM" (Receiver Autonomous Integrity Monitoring) appears after position quality indication when RAIM is in use.

*2: Version of AIS transponder is shown only for the class A AIS targets.

*3: Message is sent to AIS object when DTE (Data Terminal Equipment) cannot be used.

4.7.3 How to remove AIS data from the display area

Place the cursor on a desired tracked object and press the **TGT CANCEL** key. The select object's data is no longer displayed in the data display area.

4.8 How to Change AIS Symbol Attributes

The AIS symbol's brilliance, size and color can be changed.

4.8.1 How to adjust the AIS symbol brilliance

1. Place the cursor on the [BRILL] box, then press the **right button**. The [BRILL] menu appears.
2. Select [AIS SYMBOL], then push the **ADJUST** knob.
3. Using the **ADJUST** knob, adjust the brilliance to the appropriate level, then push the **ADJUST** knob.
4. Press the **right button** to close the menu.

4.8.2 How to change the AIS symbol color

1. Open the [MAIN MENU].
2. Select [TT•AIS], then push the **ADJUST** knob.
3. Select [TT•AIS SYMBOL], then push the **ADJUST** knob.
4. Select [SYMBOL COLOR], then push the **ADJUST** knob.
5. To cycle through the colors for the AIS symbols, rotate the **ADJUST** knob. To select the color, push the **ADJUST** knob. The available colors, in order, are: [GRN] (Green) → [BLU] (Blue) → [CYA] (Cyan) → [MAG] (Magenta) → [WHT] (White) → [GRN]...
6. Select [AIS SCALED SYMBOL], then push the **ADJUST** knob.
7. Select [OFF] or [ON] as appropriate, then push the **ADJUST** knob.
[OFF]: All AIS symbols are displayed in the same size.
[ON]: AIS symbols are displayed in scale, according to the ship length.
The figure to the right shows examples of standard and scaled symbols.
8. Close the menu.

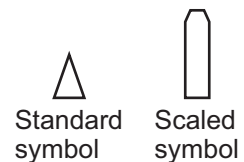

4.8.3 How to change the ATON symbol color

1. Open the [MAIN MENU].
2. Select [TT•AIS], then push the **ADJUST** knob.
3. Select [TT•AIS SYMBOL], then push the **ADJUST** knob.
4. Select [ATONSYMBOL COLOR], then push the **ADJUST** knob.
5. To cycle through the colors for the ATON symbols, rotate the **ADJUST** knob. To select the color, push the **ADJUST** knob. The available colors, in order, are: [GRN] (Green) → [BLU] (Blue) → [CYA] (Cyan) → [MAG] (Magenta) → [WHT] (White) → [GRN]...
6. Close the menu.

4.9 Past Position Display

The past position display shows equally time-spaced dots marking past positions of activated class A and B AIS targets and SAR vessels. A new dot is added at preset time intervals until the preset number is reached. If a target changes its speed, the spacing will be uneven. If it changes course, its plotted course will not be a straight line.

Below are examples of past position displays.



(a) Ship turning (b) Ship running straight (c) Ship reduced speed (d) Ship increased speed

4.9.1 How to set the past position plotting interval

The plotting interval determines how often the target's past position is refreshed. To change the plotting interval do the following:

Place the cursor on the plotting interval for the [Past POSN] indication in the [TT•AIS] box, then press the **left button** to cycle through the intervals.

Past POSN indication  Plotting interval

The available options, in order, are: [OFF] → [30 SEC] → [1 MIN] → [2 MIN] → [3 MIN] → [6 MIN] → [OFF]...

To erase all past position points and disable the past position display, select [OFF].

4.9.2 How to select the number of past position points to display

1. Open the [MAIN MENU].
2. Select [TT•AIS], then push the **ADJUST** knob.
3. Select [TT•AIS SYMBOL], then push the **ADJUST** knob.
4. Select [TT•AIS PAST POSN POINTS], then push the **ADJUST** knob.
5. Select [5] or [10] as appropriate, then push the **ADJUST** knob.
6. Close the menu.

4.9.3 Past position display orientation

Past position orientation, true or relative, is controlled with [TRAIL MODE] in the [TRAIL] context menu. To adjust the trail orientation, see subsection 1.36.1.

4.9.4 Stabilization in true motion

True motion past position display can be ground stabilized or sea stabilized. The [TRAIL] box shows current stabilization as "TRUE-G" or "TRUE-S". To change stabilization mode, open the [SHIP SPEED MENU] menu and set [SHIP SPEED] to [LOG(BT)] (ground stabilization) or [LOG(WT)] (sea stabilization).

4.10 AIS Lost Object

An AIS object is declared a lost target when it fails to produce data for six minutes or five reporting intervals, whichever is the shorter. When this occurs, the object is marked with the (flashing) lost symbol, the buzzer sounds and an appropriate alert message appears.

AIS object type		Lost alert
AIS targets	Class A target	AIS TARGET LOST
	Class B target	AIS TARGET LOST
AIS data report	AIS base station	-
	AIS SAR aircraft	-
	Physical AIS AtoN	AIS ATON LOST
	Virtual AIS AtoN	AIS ATON LOST
	Mobile AIS AtoN	AIS ATON LOST
	Mobile Virtual AIS AtoN	AIS ATON LOST
	Synthetic AIS AtoN	AIS ATON LOST
AIS locating device	AIS SART* (active)	AIS SART LOST
	AIS SART* (test)	-
AIS synthetic target	AIS synthetic target	-

*: Includes AIS-SART, AIS MOB AND EPIRB-AIS.

To acknowledge a lost target, press the **ALERT ACK** key, or use the Touchpad to select the [ALERT] box then press the **left button**.

4.10.1 How to set the AIS lost object filter

If you are in an area where AIS objects often become lost, the lost alert may activate frequently. In this case, you may want to specify which objects to classify as lost objects, to prevent frequent triggering of the lost alert.

1. Open the [MAIN MENU].
2. Select [TT•AIS], then push the **ADJUST** knob.
3. Select [AIS LOST TGT FILTER], then push the **ADJUST** knob.
4. Referring to the table below, select the appropriate filtering type, then push the **ADJUST** knob.

Filter type	Definition
[MAX RANGE]	Any AIS targets beyond the range set here will not trigger the lost target alert.
[MIN SHIP SPEED]	Any AIS targets slower than this setting will not trigger the lost target alert.
[CLASS B]	Select ON to prevent AIS targets class B triggering the lost target alert. Select ON to exclude Class B AIS targets from the lost target alert.
[ATON]	Select ON to exclude AIS AtoN targets from the lost target alert.
[SART]	Select ON to exclude AIS SART targets from the lost target alert.

5. Select [ON], then push the **ADJUST** knob. The settings can now be adjusted.
Note: If some menu item on the [AIS LOST FILTER] menu is set to ON, the message "Some lost warning function is disabled" appears at the bottom of the menu.
6. Rotate the **ADJUST** knob to adjust the setting as required, then push the **ADJUST** knob to apply the setting.
7. Close the menu.

4.10.2 How to enable/disable the AIS lost alert

The lost alert box at the bottom right corner enables and disables the AIS lost alert. Select the box with the cursor, then press the **left button** to select [OFF], [ALL] or [FILT] as appropriate.

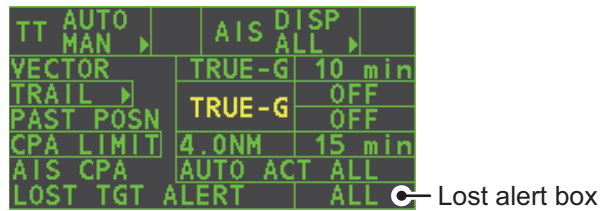

- [OFF]: Disables the alert.
- [ALL]: Enables the alert against all lost objects.
- [FILT]: Enables the alert against the targets whose criteria meet the settings made in section 4.10.1.

If some menu item on the [LOST FILTER] menu is set to [ON], [FILT] appears in yellow.

Note: The filter setting is applied to both TT and AIS lost targets.

4.11 ROT Setting

You can set the lower limit of the ROT (Rate Of Turn) at which the heading line on symbols will point in direction which the vessel is turning.

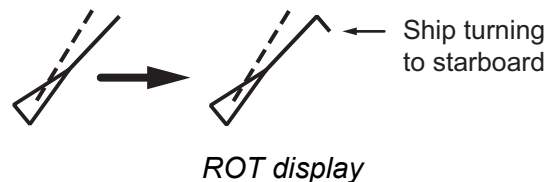

1. Open the [MAIN MENU].
2. Select [TT•AIS], then push the **ADJUST** knob.
3. Select [TT•AIS SYMBOL], then push the **ADJUST** knob.
4. Select [AIS ROT TAG LIMIT], then push the **ADJUST** knob. The settings can now be adjusted.
5. Using the **ADJUST** knob, adjust the ROT as appropriate. Rotate the **ADJUST** knob to adjust the value, push the **ADJUST** knob to move to the next digit. The setting range is 000.0°/min to 720.0°/min.
6. Close the menu.

4.12 AIS CPA/TCPA Alarm

This radar calculates CPA and TCPA by using own ship and relative target positions. An AIS dangerous target is one whose CPA and TCPA are within the range of the CPA and TCPA limits set in the TT/AIS box. The AIS symbol of an AIS dangerous target is red and flashing, and is announced with the alert "CPA/TCPA". After the alert is acknowledged the target symbol is displayed in red color.

Note: Only activated class A and B AIS targets trigger the CPA/TCPA alarm.

Dangerous target

When a sleeping or an activated target violates the CPA/TCPA alarm setting its symbol changes to the dangerous target symbol (red and flashing) and the message "CPA/TCPA" appears. Press the **ALERT ACK** key (or click the [ALERT] box with the left button) to acknowledge the CPA/TCPA alarm. The audible alarm is silenced and the symbol stops flashing. Take appropriate action to avoid collision.

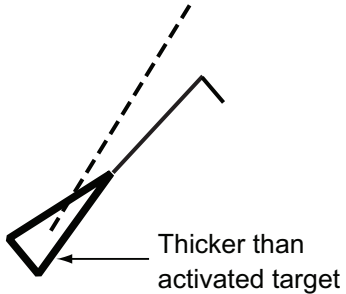

4.12.1 How to set the CPA and TCPA ranges

CPA and TCPA ranges can be adjusted from the appropriate indication in the [TT•AIS] box. If the CPA/TCPA settings are displayed as "OFF", place the cursor on the CPA limit indication, then press the **left button**.

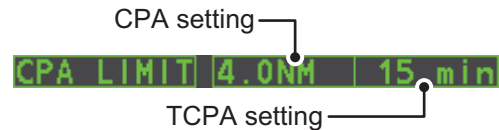

1. Place the cursor on the indication you wish to adjust.
2. Press the **left button**, or rotate the **ADJUST** knob, to adjust the settings as required. The settings options are outlined in the table below.

Indication	Key	Settings options
CPA	Left button	0.5, 1, 1.5, 2, 3, 4, 5, 6 (nm)
	ADJUST knob	0.1-20 (nm), 0-10 nm in 0.1 nm increments, 10 nm increments thereafter
TCPA	Left button	1, 2, 3, 4, 5, 6, 12, 15 (minutes)
	ADJUST knob	1-60 minutes, 1-minute increments

4.13 How to Associate TT and AIS Targets

An AIS-equipped ship is usually displayed by two symbols on the radar display. This is because the AIS ship position is measured by a GPS navigator (L/L) whereas the radar detects the same ship by PPI principle (range and bearing relative to own ship radar antenna).

To avoid the presentation of two target symbols for the same physical target, use the "association" function. If target data from both AIS and TT are available and if the association criteria are fulfilled, either the AIS or TT symbol is presented according to the association method selected.

Association will not happen between AIS and TT if the AIS target is sleeping or the AIS target is lost.

Note: Only activated AIS class A and B targets are covered by the association feature.

1. Confirm that the [TT ACQ MODE] indication shows "AUTO", "AUTO MAN" or "MAN".



2. Open the [MAIN MENU].
3. Select [TT•AIS], then push the **ADJUST** knob.
4. Select [ASSOCIATION], then push the **ADJUST** knob.
5. Select [ASSOCIATION TGT], then push the **ADJUST** knob.
6. Select [OFF], [AIS] or [TT], as appropriate, to select which symbols and data to display when the association criteria are met.
 - **[OFF]**: Disable association.
 - **[AIS]**: Use AIS symbols and AIS data.
 - **[TT]**: Use TT symbols and TT data.

Note: Association can also be switched on and off from the screen by left-clicking the Association Usage icon, shown below.



Place the cursor on the association icon, then press the **left button** to change the association setting.

>: Use TT Symbols and data.

<: Use AIS symbols and data.

No indication: Association is disabled.

7. Referring to the table below, set the association criteria. Rotate the **ADJUST** knob to adjust the value, push the **ADJUST** knob to move to the next digit.

[GAP]:	Range in bearing direction between AIS target and tracked target. (setting range: 0.000-0.050 (nm))
[RANGE]:	Range direction difference from own ship to AIS target and tracked target. (setting range: 0.000-0.100 (nm))
[BEARING]:	Bearing difference from own ship to AIS target and tracked target. (setting range: 0.0-9.9 (°))
[SPEED]:	Speed difference between AIS target and tracked target. (setting range: 0.0-6.0 (kn))
[COURSE]:	Course difference between AIS target and tracked target. (setting range: 0.0-25.0 (°))

4. AIS OPERATION

8. Close the menu.

When the association criteria (gap, range, bearing, speed, and course) is met, and the [ASSOCIATION TARGET] setting is [AIS], the TT symbol is erased and only the AIS symbol is displayed. Further, "ASSOCIATION" appears in the [ALERT] Box.

All default association settings are restored whenever the power is turned on.

4.14 How to View Own Ship Data

Own ship's static data (type of ship, call sign, name and position of internal and external GPS antennas) can be viewed as follows:

1. Select the [AIS] box at the right of the screen, then press the **right button**. The [AIS TARGET MENU] appears.



2. Select [STATIC DATA], then push the **ADJUST** knob.

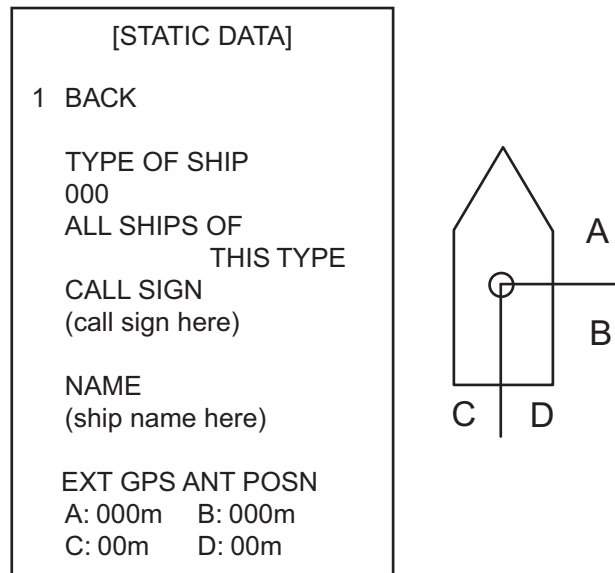

3. Close the menu.

4.15 How to Use AIS Messages

You can transmit and receive messages via the AIS, to a specified destination (MMSI) or all ships in the area. Messages can be sent to warn of safety of navigation, for example, an iceberg sighted. Routine messages are also permitted.

Short safety related messages are only an additional means to broadcast safety information. They do not remove the requirements of the GMDSS.

4.15.1 How to create and save messages

Up to ten messages can be saved at any time. To create and save a message, do the following:

Note: The MMSI of the receiving ship can be automatically set by selecting [TRANSMIT MESSAGE] from the pop up menu. To show the pop up menu, select the receiving ship's data in the AIS data display area, then press the **right button**.

1. Select the [AIS] box at the right of the screen, then press the **right button**. The [AIS TARGET MENU] appears.
2. Select [TRANSMIT MESSAGE], then push the **ADJUST** knob.
3. Select [ADDRESS TYPE], then push the **ADJUST** knob.
4. Select [ADDRESSED] (message for a specific MMSI. Automatically selected if the MMSI is automatically using the data display.) or [BROADCAST] (message to all AIS-equipped vessels within the area), then push the **ADJUST** knob.
5. Select [MESSAGE TYPE], then push the **ADJUST** knob.
6. Select [SAFETY] (for safety messages) or [BINARY] (for routine messages), then push the **ADJUST** knob.
7. For [ADDRESSED] message, do this step. For [BROADCAST] message, or if [TRANSMIT MESSAGE] was selected from the AIS data display pop up menu, go to step 8.
 - 1) Select [MMSI No.], then push the **ADJUST** knob.
 - 2) Using the **ADJUST** knob, set the receiving ship's MMSI.
8. Select [CHANNEL], then push the **ADJUST** knob.
9. Select the AIS channel to transmit your message over: [A], [B], [A or B], or [A and B], then push the **ADJUST** knob.
10. Select [EDIT], then push the **ADJUST** knob. A software keyboard appears at the bottom of the menu.
11. Select the character desired, then press the **left button**.

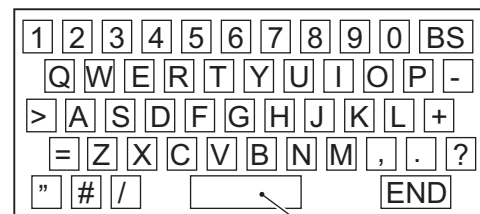

The maximum number of characters which can be entered depends on the message type, as shown in the table on the following page.

Message type	Max. characters allowed
Safety message broadcast	161
Binary message broadcast	156
Safety message addressed to MMSI	156
Binary message addressed to MMSI	151

4. AIS OPERATION

12. Select [OK], then push the **ADJUST** knob.
13. Select [SAVE FILE], then push the **ADJUST** knob.
14. Select the appropriate number, then push the **ADJUST** knob.
15. Close the menu.

4.15.2 How to transmit messages

1. Select the [AIS] box at the right of the screen, then press the **right button**. The [AIS TARGET MENU] appears.
2. Do one of the following:
 - a) Create a message, as described in subsection 4.15.1.
 - b) Use a file saved in the memory by selecting [TRANSMIT MESSAGE] followed by [OPEN FILE].
3. Select [TRANSMIT MESSAGE] to transmit the message.
The indication "AIS TRANSMITTING" appears while sending the message.
"TRANSMIT ERROR" appears if an error occurred while transmitting the message.
4. Close the menu.

Note: A message cannot be sent to an MMSI when [ADDRESS TYPE] is [ADDRESSED] when the AIS's DTE (Data Terminal Equipment) is unavailable.

4.15.3 How to view messages

Received AIS messages are stored in the AIS received message list. If [AUTO DISP MESSAGE] in the [AIS TARGET MENU] is set to [ON], messages are automatically displayed upon receipt. The maximum number of messages that can be stored is as follows:

- **Addressed message:** Max. 100 messages (a maximum of 20 messages can be protected.)
- **Broadcast message:** Max. 100 messages (a maximum of 20 messages can be protected.)
- **AtoN message:** Max. 50 messages (message cannot be protected.)
- **SART message:** Max. 50 messages (message cannot be protected.)

When the memory capacity is reached and a new message is received, the oldest message (excluded the protected message) is automatically deleted to make room for the latest. The AtoN messages are deleted after 18 minutes. When a AtoN or SART is lost, the messages whose MMSI is same with the lost object are automatically deleted.

How to view, protect, delete messages

You can access the received messages from the menu as follows:

1. Select the [AIS] box at the right of the screen, then press the **right button**. The [AIS TARGET MENU] appears.
2. Select [RECEIVED MESSAGES], then push the **ADJUST** knob to show the [RECEIVED MESSAGES] list.



3. To filter the list by AIS type, or message type, do as follows. Otherwise, go to step 4.
4. Select the message to display, then push the **ADJUST** knob. Below is a sample message.

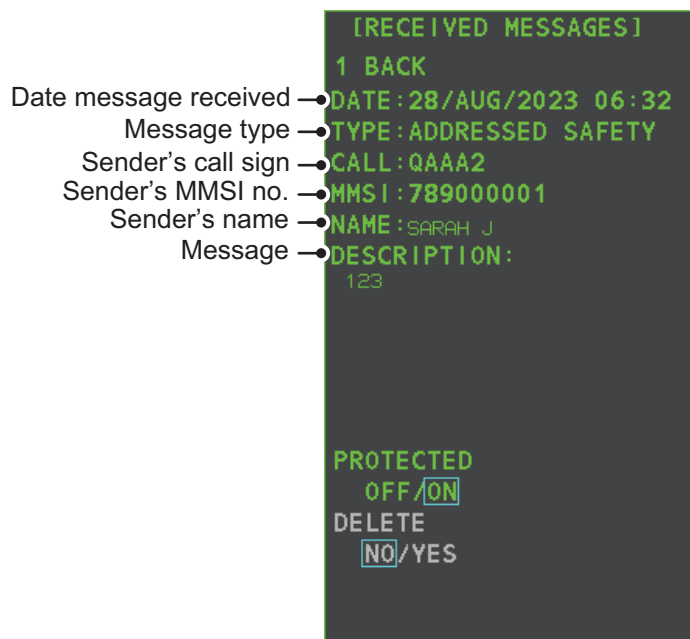

5. To protect or delete a message, do as follows. Otherwise, go to step 6, **Protect a message**: Set [PROTECTED] to [ON]. The protect symbol (🛡️) appears to the right of a protected message on the message list. (See the illustration on the preceding page for the location.) To unprotect a message, select [OFF].

4. AIS OPERATION

Delete a message: Set [DELETE] to [YES]. You are asked if you are sure to delete the message. Push the **ADJUST** knob to delete the message.

6. Close the menu.

How to filter the message list

You can filter the message list by AIS type or message type as follows.

1. Right click the mail icon (✉) on the [TT/AIS] box (bottom right corner) to display the [MESSAGE OPTION] window, shown below.

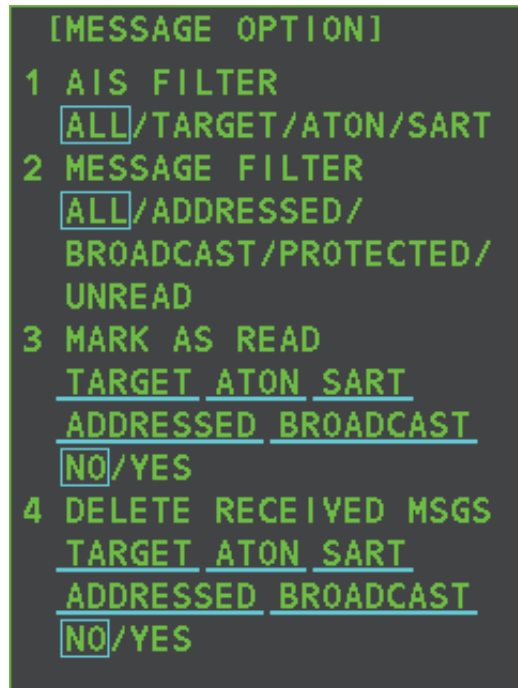

2. Use the **ADJUST** knob to select [AIS FILTER] or [MESSAGE FILTER], then push the knob.
3. Rotate the **ADJUST** knob to select desired option, referring to the description below, then push the knob to confirm selection.
 - [AIS FILTER]
 - [ALL]: Show all received messages.
 - [TARGET]: Show only the AIS messages received from the AIS-equipped ships, SAR aircrafts and AIS base stations.
 - [SART]: Show only the AIS message received from the SART.
 - [ATON]: Show only the AIS message received from the AtoN.
 - [MESSAGE FILTER]
 - [ALL]: Show all received messages.
 - [ADDRESSED]: Show only the addressed messages.
 - [BROADCAST]: Show only the broadcasted messages.
 - [PROTECTED]: Show only the protected messages.
 - [UNREAD]: Show only the unread messages.

- [MARK AS READ]
 - [TARGET]: Mark all messages received from the AIS-equipped ships, SAR aircrafts and AIS base stations as read.
 - [ATON]: Mark all AtoN AIS messages as read.
 - [SART]: Mark all SART AIS messages as read.
 - [ADDRESSED]: Mark all addressed messages as read.
 - [BROADCAST]: Mark all broadcast messages as read.
- [DELETE RECEIVED MSGS]
 - [TARGET]: Delete all AIS messages from the AIS-equipped ships, SAR aircrafts and AIS base stations.
 - [ATON]: Delete all AtoN AIS messages.
 - [SART]: Delete all SART AIS messages.
 - [ADDRESSED]: Delete all addressed messages.
 - [BROADCAST]: Delete all broadcast messages.

4.15.4 How to automatically display received messages

1. Select the [AIS] box at the right of the screen, then press the **right button**. The [AIS TARGET MENU] appears.
2. Select [AUTO DISP MESSAGE], then push the **ADJUST** knob.
3. Select [ON] to display messages as they are received, [OFF] to disable the automatic display, then push the **ADJUST** knob.
4. Close the menu.

4.16 AIS System Messages

AIS system messages appear at the bottom right corner of the screen. The table below shows the AIS system messages and their meanings.

Message	Priority	Meaning
"ACTIVE AIS 95%"	Caution	Number of active AIS targets has reached 38.
"ACTIVE AIS FULL"	Warning	Number of active AIS targets has reached 40.
"AIS ATON LOST"	Warning	An AIS AtoN is declared a lost object when it fails to produce data for six minutes or five reporting intervals, whichever is the shorter.
"AIS CPTY 95%"	Caution	Number of AIS targets has reached 950.
"AIS CPTY FULL"	Caution	Number of AIS targets has reached 1000.
"AIS DATREP FULL"	Caution	Number of AIS data reports has reached 40.
"AIS DISPLAY 95%"	Caution	Number of displayed AIS targets has reached 285.
"AIS DISPLAY FULL"	Warning	The radar only displays the closest 300 AIS targets from own ship.
"AIS MSG SEND ERR"	Caution	Could not send AIS message.
"AIS NEW TARGET"	Warning	AIS object has entered an acquisition zone.
"AIS SART FULL"	Caution	Number of AIS locating devices has reached 20.
"AIS SART LOST"	Warning	An AIS SART is declared a lost object when it fails to produce data for six minutes or five reporting intervals, whichever is the shorter.
"AIS SYN TGT FULL"	Caution	Number of AIS synthetic targets has reached 40.
"AIS TARGET LOST"	Warning	An AIS object is declared a lost object when it fails to produce data for six minutes or five reporting intervals, whichever is the shorter.
"CPA/TCPA"	Alarm	CPA and TCPA of an activated AIS target are below value set on the menu.
"LOST AIS COM"	Warning	Not receiving AIS data from own AIS (VDO message).

5. VIDEO PLOTTER OPERATION

The video plotter has the following functions:

- Enter waypoints (up to 98) and marks.
- Creates and displays radar maps.
- Own ship track plotting
- Able to save marks and tracks on removable SD-card.

5.1 Orientation Modes

Six orientation modes are available:

[HEAD UP RM], [STAB HEAD UP RM],[STERN UP RM], [COURSE UP RM], [NORTH UP RM], [NORTH UP TM] (True Motion).

Note 1: The [STERN UP RM] orientation mode is only available if it has been set to [ON] in [STERN UP RM] in the [INITIAL SETTING] → [OPERATION] menu.

Note 2: The screen may flash when the heading is changed more than one degree in the [HEAD UP RM] or [STAB HEAD UP RM] mode.

Automatic resetting of own ship mark in true motion mode

In the true motion mode, the own ship mark is automatically returned stern-ward 75% from the screen center when it reaches a location 50% of the display radius.

To select an orientation mode, see "How to select an presentation mode" on page 1-31.

5.2 Radar Map

A radar map is a combination of map lines and symbols whereby the user can define and input the navigation data, route planning and monitoring data. The radar map can contain 5,000 points of data. Inscribed marks are retained when the power is turned off.

The radar map is reference to the WGS-84 datum and is displayed only when there is valid position data input. The radar map does not affect any radar functions.

5.2.1 How to show/hide the radar map

Select the [MAP] indication in the [RADAR CONTROL BOX] at the left-side of the screen, then press the **left button** to display or hide the radar map.



5.2.2 Radar map marks

To inscribe/remove marks or change mark colors on the radar map, see "How to Use Marks" on page 1-54. The following mark icons are available.

Non-IMO type*1	Item on MARK menu	IMO type*2	Item on MARK menu
	Mark	Red	Buoy
	Danger Highlight	Green	Buoy
	Buoy	Red	Buoy
	Buoy	Green	Buoy
	Buoy	Red	Buoy
	Buoy	Green	Buoy
.	Buoy	Red	Buoy
	Danger Highlight	Green	Buoy
	Mark	Purple	Danger Highlight
	Mark	Purple	Danger Highlight
	Mark	Orange	Mark
	Mark	Orange	Mark
	Mark	Orange	Mark
	Mark	Purple	Navline (map)
	Mark	White	Coastline
	Nav Line (map)	Gray	Contour Line
	Coastline	Purple	Danger Highlight
	Contour	Purple (cable)	Danger Highlight
	Prohibited Area	Orange	Mark
(cable)	Danger Highlight	Orange	Mark
(w/line)	Buoy	*1: Colors for non-IMO marks may be set by the user. *2: Colors for IMO marks are fixed as indicated.	
(w/line)	Mark		
(w/line)	Mark		
(w/line)	Mark		

5.3 How to Align the Radar Map

When there is positional error between the radar screen and radar map marks and lines, do the following to correct it.

Note: Activating/deactivating the [MAP ALIGN] function resets own ship track and all trails.

1. Select the operational display area, then press the **right button**. The [CURSOR MENU] appears.
2. Select [MAP ALIGN], then press the **left button**. The cursor color changes to blue.
3. Move the cursor to align the radar map with the radar screen, then press the **left button**. The indication "MAP ALIGN" appears on the right side of the operational display area.

Display indications affected by map alignment

The following items are also re-aligned when the [MAP ALIGN] function is activated.

- Radar echoes
- Cursor position co-ordinates
- EBL offsets (STAB HDG & STAB NORTH modes only)
- PI Lines
- Acquisition Zone set area
- Barge mark
- TT symbols
- EBL/VRM reference points
- ZOOM window display
- Anchor Watch
- AIS symbol vector display (REL mode only)
- Own ship location co-ordinates (POSN display only)

Display indications unaffected by map alignment

The following items are not re-aligned when the [MAP ALIGN] function is activated.

- WPT/Route
- DROP mark
- EBL offsets (STAB GND mode only)
- AIS symbol vector display (TRUE mode only)
- AIS symbols
- MOB
- TT symbol vector display
- Zoom window display (STAB GND mode only)

5.3.1 How to disable the map alignment

1. Select the operational display area, then press the **right button**. The [CURSOR] menu appears.
2. Select [MAP ALIGN], then press the **left button**. The cursor color changes to blue.
3. Press and hold the **left button**. The "MAP ALIGN" indication is cleared.

5.4 Own Ship's Track

A total of 1,200 points are allotted for storage of own ship's track, marks and lines. When this memory becomes full, the oldest track is deleted to make room for the latest. For that reason you may want to adjust the recording interval to conserve the memory.

The table below shows the relation between plotting interval settings and maximum track recording time.

Interval	Max. Recording Time	Interval	Max. Recording Time
15 s	5 hours	3 min	60 hours
30 s	10 hours	6 min	120 hours
1 min	20 hours	15 min	300 hours
2 min	40 hours	DRAW ONLY	No track data recorded.

5.4.1 How to set the plotting interval

1. Open the [MAIN MENU].
2. Select [MARK], then push the **ADJUST** knob.
3. Select [OWN TRACK], then push the **ADJUST** knob.
4. Select [SAVE INTERVAL], then push the **ADJUST** knob.
5. Select the appropriate setting, then push the **ADJUST** knob.
6. Close the menu.

5.4.2 How to set the own ship track color

1. Open the [MAIN MENU].
2. Select [MARK], then push the **ADJUST** knob.
3. Select [OWN TRACK], then push the **ADJUST** knob.
4. Select [OWN TRACK COLOR], then push the **ADJUST** knob. The following colors are available.

Non-IMO type	IMO type
<ul style="list-style-type: none"> • [RED] (Red) • [GRN] (Green) • [BLU] (Blue) • [YEL] (Yellow) • [CYA] (Cyan) • [MAG] (Magenta) • [WHT] (White) 	OWN TRACK COLOR is not adjustable for IMO type radars. Own track appears in (Cyan) color.

5. Select the appropriate setting, then push the **ADJUST** knob.
6. Close the menu.

5.4.3 How to delete the own ship track

There are three methods to delete the own ship track: by percentage of track, by track color or by cursor selection.

How to erase tracks by percentage

1. Open the [MAIN MENU].
2. Select [MARK], then push the **ADJUST** knob.
3. Select [OWN TRACK], then push the **ADJUST** knob.
4. Select [DELETE OWN TRACK], then push the **ADJUST** knob.
5. Select the percentage of the track you wish to delete, then push the **ADJUST** knob. The available options are: [30%], [50%], [80%] or [ALL].
6. Close the menu.

How to erase tracks by color (For non-IMO type only)

1. Open the [MAIN MENU].
2. Select [MARK], then push the **ADJUST** knob.
3. Select [OWN TRACK], then push the **ADJUST** knob.
4. Select [DELETE OWN TRACK], then push the **ADJUST** knob.
5. Select the color of the track you wish to delete, then push the **ADJUST** knob. The available options are: [RED], [GRN], [BLU], [YEL], [CYA], [MAG] or [WHT].
6. Close the menu.

How to erase tracks with the cursor (For non-IMO type only)

1. Open the [MAIN MENU].
2. Select [MARK], then push the **ADJUST** knob.
3. Select [OWN TRACK], then push the **ADJUST** knob.
4. Select [OWN TRACK DELETE], then push the **ADJUST** knob.
5. Select [2POINTS] or [AREA] as appropriate, then push the **ADJUST** knob. The cursor jumps into the operational display area.
[2POINTS]: Delete track between two points
[AREA]: Delete all track within an area

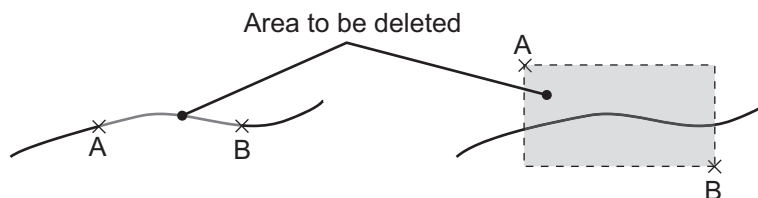

[2POINTS] method

[AREA] method

6. Place the cursor on the first point (A), then press the **left button**.
7. Place the cursor on the second point (B), then press the **left button**. If [AREA] was selected at step 5, the two points form a square.
8. Close the menu.

5.5 How to Use Waypoints

A particular location is known as a “waypoint”, whether it be a starting point, a destination point or an intermediate point on a voyage. This radar system can store 100 waypoints. Waypoints 1 to 98 are user set waypoints, waypoint 199 is reserved for external input, waypoint 200 is reserved for MOB (Man Over Board). Waypoints can be entered with the cursor, or from the menu (manual input of latitude and longitude). Waypoints 1 to 98 can be edited from the menu.

5.5.1 How to enter waypoints

How to enter waypoints with the cursor

1. Select the [MARK] box, then press the **right button**. The [MARK] menu appears.
2. Select [MARK KIND], then push the **ADJUST** knob.
3. Select the appropriate waypoint number group for the new waypoint, then push the **ADJUST** knob.
The available groups are: [WP1 to WP50] or [WP51 to WP98].
4. Rotate the **ADJUST** knob to select the waypoint number for new waypoint, then push the **ADJUST** knob. The cursor jumps inside the operational display area.
5. Place the cursor on the location to inscribe the waypoint, then press the **left button**.
6. Repeat steps 4 and 5 to inscribe other waypoints.
7. Press the **right button** to complete waypoint inscription.

How to enter/edit waypoints from the menu

Note: Waypoints which are part of a route that is currently in use cannot be edited.

1. Open the [MAIN MENU].
2. Select [NAVLIN•WPT], then push the **ADJUST** knob.
3. Select [WPT SET], then push the **ADJUST** knob.
4. Select [WPT NO. SELECT], then push the **ADJUST** knob.
5. Rotate the **ADJUST** knob to select a waypoint number, then push the **ADJUST** knob.
6. To edit or input a waypoint name, select [WPT NAME], then push the **ADJUST** knob. The software keyboard appears. To skip naming the waypoint, go to step 7.
 - 1) Select a character, then press the **left button**. Repeat the process to name the waypoint. A total of 15 characters can be used when naming the waypoint.
 - 2) Select [END] to complete naming the waypoint.
7. Select [WPT L/L], then push the **ADJUST** knob. The settings can now be adjusted.
8. Rotate the **ADJUST** knob to select a digit, then push the **ADJUST** knob to move to the next digit. Use this method to set the Latitude and Longitude.
9. Close the menu.

How to enable the arrival alert

Arrival WPT is a function to alert when own ship nears a waypoint by a preset distance. Alert range is shown to your radar with orange hashed line as follow:

Note: Set [NAV LINE DATA SOURCE] on [NAV LINE•WPT] to [EXT DATA] in advance.

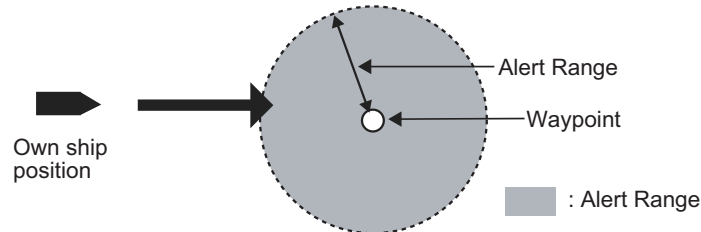

- 1) Open the [MAIN MENU].
- 2) Select [ALERT], then push the **ADJUST** knob.
- 3) Select [ARRIVAL WPT], then push the **ADJUST** knob.
- 4) Select [ON] to enable [ARRIVAL WPT].
- 5) Rotate **ADJUST** knob to select a digit (0.00 NM~9.99 NM), then push the **ADJUST** knob.
- 6) Close the menu.

5.5.2 How to erase waypoints

1. Open the [MAIN MENU].
2. Select [NAVLIN•WPT], then push the **ADJUST** knob.
3. Select [WPT SET], then push the **ADJUST** knob.
4. Select [WPT NO. SELECT], then push the **ADJUST** knob.
5. Select [CLEAR DATA], then push the **ADJUST** knob.
6. Select [YES] or [NO] as appropriate, then push the **ADJUST** knob.
7. Close the menu.

5.5.3 How to display the waypoint list

1. Open the [MAIN MENU].
2. Select [NAVLIN•WPT], then push the **ADJUST** knob.
3. Select [WPT LIST], then push the **ADJUST** knob.
4. Close the menu.

5.5.4 How to show/hide the waypoint name/number





1. Open the [MAIN MENU].
2. Select [NAVLIN•WPT], then push the **ADJUST** knob.
3. Select [DISP WPT NO.] or [DISP WPT NAME] as appropriate, then push the **ADJUST** knob.
4. Select [YES] to show the waypoint name/number, or [NO] to hide the waypoint name/number, then push the **ADJUST** knob.
5. Close the menu.

5. VIDEO PLOTTER OPERATION

This page is intentionally left blank.

6. MAINTENANCE, TROUBLE-SHOOTING

Periodic checks and maintenance are important for proper operation of any electronic system. This chapter contains maintenance and troubleshooting instructions to be followed to obtain optimum performance and the longest possible life of the equipment. Before attempting any maintenance or troubleshooting procedure please review the safety information below.

 WARNING	
	<p>Do not open the equipment.</p> <p>Hazardous voltage which can cause electrical shock exists inside the equipment. Only qualified personnel should work inside the equipment.</p>
	<p>Turn off the radar power switch before servicing the antenna unit. Post a warning sign near the switch indicating it should not be turned on while the antenna unit is being serviced.</p> <p>Prevent the potential risk of being struck by the rotating antenna.</p>
	<p>A transmitting radar antenna emits electromagnetic waves, which can be harmful, particularly to the eyes.</p> <p>Never look directly into the antenna aperture from a close distance while the radar is in operation, or expose yourself to the transmitting radar at a close distance.</p>
	<p>Wear a safety belt and hard hat when working on the antenna unit.</p> <p>Serious injury or death can result if someone falls from the radar antenna mast.</p>

NOTICE

Do not apply paint, anti-corrosive sealant or contact spray to coating or plastic parts of the equipment.

Those items contain organic solvents that can damage coating and plastic parts, especially plastic connectors.

6.1 Periodic Maintenance Schedule

Regular maintenance is essential to good performance. A regular maintenance program should be established and should at least include the items shown in the table below.

Interval	Check Point	Checks and measures	Remarks
As required	The LCD will in time accumulate a layer of dust which tends to dim the picture	Wipe the LCD carefully to prevent scratching, using tissue paper and an LCD cleaner. To remove stubborn dirt, use an LCD cleaner, wiping slowly with tissue paper so as to dissolve the dirt. Change paper frequently so the dirt will not scratch the LCD.	Do not use chemical-based cleaners to clean the LCD. They can damage the LCD coating.
	Processor unit cleanliness	Dust and dirt may be removed with a soft cloth.	Do not use chemical-based cleaners to clean the processor unit. They can remove paint and markings.
3 to 6 months	Exposed nuts and bolts on antenna unit	Check for corroded or loosened nuts and bolts. If necessary, clean and repaint them thickly. Replace them if heavily corroded.	Sealing compound can be used instead of paint. Apply a small amount of grease between nuts and bolts for easy removal in future.
	Antenna radiator	Check for dirt and cracks on radiator surface. Thick dirt should be wiped off with soft cloth dampened with fresh water. If a crack is found, apply a slight amount of sealing compound or adhesive as a temporary remedy, then call for repair.	Do not use chemical-based cleaners for cleaning. They can remove paint and markings. If you need to remove ice from the antenna unit, use a wooden hammer or plastic head hammer. Cracks on the unit may cause water ingress, causing serious damages to internal circuits.
	Terminal strips and plugs in antenna unit (TECHNICIANS only)	Open antenna cover to check terminal strip and plug connections inside. Also check the rubber gasket of antenna covers for deterioration.	When closing antenna covers in position, be careful not to catch loose wires between covers and unit.
6 months to one year	Terminal strips, sockets, earth terminal on processor unit (TECHNICIANS only)	Check for loose connections. Check contacts and plugs for proper seating, etc.	

6.2 How to Replace the Fuse

A fuse is located on the front of the processor unit. The fuse protects the equipment from reverse polarity of the ship's mains and equipment fault. If a fuse blows, find the cause before replacing it. Use the correct fuse. Using the wrong fuse will damage the equipment and void the warranty.

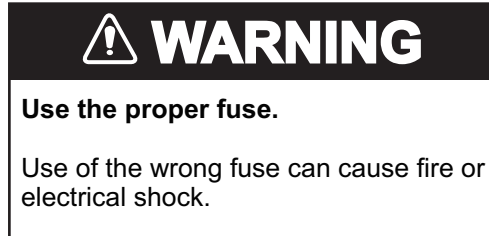

AC/DC	Type	Code No.
DC	FGBO-A 125V 15A PBF	000-155-827
AC	FGBO-A 250V 8A PBF	000-155-843

6.3 Life Expectancy of Major Parts

This radar has consumable parts, and the table that follows shows the estimated life expectancy for the consumable parts. Life expectancy estimates are based on use under normal conditions. Request a FURUNO agent or dealer to replace the consumable parts, to get the best performance and longest possible life from the equipment.

Part	Type	Life expectancy	Remarks
Antenna Motor	D8G-516	10,000 hours	
	D8G-571		
Carbon Brush	S885026-1A-61	4,000 hours	Check for wear at, or before, 2,000 hours of Tx time. Replace if worn.
Magnetron	MA1615B	5,000 hours	Check no. of hours used at Tx time. Reset time after replacement.
	MG5436		
	MAF1565N		
	M1458F		
MD Board (FAR-1518)	ECA-1HG101B	55,000 hours	
	ECA-1HHG100B		
MD Board (FAR-1528)	ECA-1CHG101B	66,000 hours	
	ECA-1HHG100B		
MU-150HD Backlight	26-005-2026	60,000 hours	Replace when brilliance is uneven or too low.
MU-150HD Fan Motor	MFB52A-12HA-001	40,000 hours	

Note: The magnetron is a consumable item. The effectiveness of your magnetron will decrease over time, causing lower-than-normal signal strength and loss of echoes. Magnetrons should be changed regularly. The table above shows the typical life-span of a magnetron used under normal conditions.

6.4 Trackball Maintenance

If the cursor skips or moves abnormally, clean the trackball using the procedure below.

1. Turn the retaining ring counterclockwise 45° to unlock it.
2. Remove the retaining ring and ball.
3. Clean the ball with a soft, lint-free cloth, then blow carefully into the ball-cage to dislodge dust and lint.
4. Look for a build-up of dirt on the metal rollers. If dirty, clean the rollers using a cotton swab moistened lightly with isopropyl-rubbing alcohol.
5. Make sure that fluff from the swab is not left on the rollers.
6. Replace the ball and retaining ring. Be sure the retaining ring is not inserted reversely.

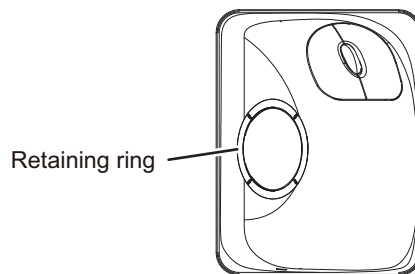

6.5 Easy Troubleshooting

This section provides troubleshooting procedures that the user can follow to restore normal operation. If you cannot restore normal operation, do not attempt to check inside any unit. Any repair work is best left to a qualified technician.

Problem	Possible cause	Remedy
Key beep inaudible.	Key beep turned off.	Adjust key beep level in the [OPERATION] menu, referring to section 1.10.
Picture not updated or picture freeze. 30 seconds after the picture freezes, the buzzer sounds, the ALERT ACK key blinks and alarm signal is output.	Video freeze.	Turn the power off and on again to restore normal operation.
Power is ON but nothing appears on monitor.	Brilliance is too low.	Adjust the brilliance, referring to section 1.3.
Marks, indications and noise appear but no echo.	Tx high voltage protection circuit has activated.	Reset the power to restore normal operation.
Range changed but radar picture does not change.	Defective range key or video freeze up.	Adjust the range with the control unit, or the [RANGE] box several times. If that does not work try to turn the power off and on again to see if the problem might be video freeze up. If unsuccessful, replacement of keypad may be required.
Only two PI lines when six lines are wanted	Incorrect setting of PI line interval	Adjust PI line interval, referring to subsection 1.39.2. Also, the setting for number of PI lines to display may be inappropriate. Check the menu setting for number of PI lines, referring to subsection 1.39.1.

Problem	Possible cause	Remedy
Range rings are not displayed	Range rings are turned off	Try turning on the range rings with [RANGE RING] in the [NAVTOOL] menu. If they do not appear, their brilliance may be too low. Adjust their brilliance in the [BRILL] menu.
Tracked target not tracked correctly	Poor definition of targets in sea clutter	Adjust A/C SEA and A/C RAIN referring to section 1.19 and section 1.20.
Tuning adjusted but poor sensitivity	Second trace echo rejector on or dirt on radiator face	<ul style="list-style-type: none"> • Disable the second trace echo rejector, referring to section 1.28. • Clean the radiator face.

6.6 Advanced-level Troubleshooting

This section describes how to cure hardware and software troubles that should be carried out by qualified service personnel.

Note 1: This radar equipment contains complex modules in which fault diagnosis and repair down to component level are not practicable by users.

Note 2: When replacement of the SPU board is necessary, the previous settings can be transferred to new SPU board as follows:

- Save your settings to a SD-card, referring to section section 1.52.
- After replacing the SPU board, load the entire contents of the SD-card to the radar, referring to section section 1.52 for the procedure.

Problem	Possible cause	Remedy
Cannot turn power on.	<ol style="list-style-type: none"> 1) Blown fuse. 2) Mains voltage/polarity. 3) Power supply board. 	<ol style="list-style-type: none"> 1) Replace blown fuse. 2) Correct wiring and input voltage. 3) Replace power supply board.
Brilliance adjusted but no picture.	SPU board	Replace SPU board.
Antenna not rotating.	<ol style="list-style-type: none"> 1) Antenna drive mechanism 2) Defective antenna drive motor relay 	<ol style="list-style-type: none"> 1) Replace antenna drive mechanism. 2) Press relay reset button.
Data and marks not displayed in Transmit status	SPU board	Replace SPU board.
Adjust GAIN with A/C SEA set at minimum. Marks and indications appear but no noise or echo.	<ol style="list-style-type: none"> 1) IF amplifier 2) Signal cable between antenna and processor unit 3) Video amplifier board 	<ol style="list-style-type: none"> 1) Replace IF amplifier. 2) Check continuity and isolation of coaxial cable. Note: Disconnect the plug and lugs at both ends of coaxial cable before checking it by ohmmeter. 3) Check video coax line for secure connection. If connection is good, replace SPU board.

6. MAINTENANCE, TROUBLESHOOTING

Problem	Possible cause	Remedy
Marks, indications and noise appear but no echo (transmission leak representing own ship position is absent)	<ol style="list-style-type: none"> 1) TX high voltage protection circuit has activated. 2) Magnetron 3) Modulator board 4) SPU board 	<ol style="list-style-type: none"> 1) Reset power to restore normal operation. 2) Check magnetron current. Replace magnetron. 3) Replace modulator board. 4) Replace SPU board.
Picture not updated or picture freeze-up	<ol style="list-style-type: none"> 1) Bearing signal generator board (in antenna unit) 2) SPU board 3) Video freeze-up 	<ol style="list-style-type: none"> 1) Check the connection of signal cables. 2) Replace SPU board. 3) Turn the radar off, then on.
Incorrect orientation of picture	<ol style="list-style-type: none"> 1) Terminal board: RFTB/RTB (inside transceiver unit) or FRP_TB board (inside processor unit) 2) SPU board 	If the message "LOST HEADLINE" appears in orange letters inside the alert box, the heading signal is lost or interrupted. Check the heading line signal cable and terminal board connections. If there is no problem with cables or connections, replace the SPU board.
Cannot operate radar from on-screen boxes	SPU board	Replace SPU board.
Radar is properly tuned but poor sensitivity	<ol style="list-style-type: none"> 1) Deteriorated magnetron 2) Detuned MIC 3) Dirt on radiator face 4) Water ingress to the waveguide or other feeder line 5) Second trace echo rejection is ON 	<ol style="list-style-type: none"> 1) With the radar transmitting on 48 nm range, check magnetron current. If current is below normal, magnetron may be defective. Replace it. 2) Check MIC detecting current. If it is below normal value, MIC may have become detuned. MIC must be tuned. 3) Clean the radiator surface. 4) Remove water from the feeder line. 5) Disable the second-trace echo rejector referring to section 1.28.
Range changed but radar picture not changing	<ol style="list-style-type: none"> 1) Defective range key 2) SPU board 3) Video freeze up 	<ol style="list-style-type: none"> 1) Adjust the range with the control unit, or the [RANGE] box several times. If unsuccessful, replacement of keypad may be required. 2) Replace SPU board. 3) Turn off and on radar.
Interference rejector is inoperative (interference rejection level not displayed)	SPU board	Replace SPU board.
Echo stretch is ineffective (neither ES1, ES2 nor ES3 is displayed)	SPU board	Replace SPU board.
Range rings are not displayed	<ol style="list-style-type: none"> 1) Adjust the brilliance of range rings on the BRILL menu to see if intensity is increased 2) SPU board 	<ol style="list-style-type: none"> 1) Replace associated circuit board if unsuccessful. 2) Replace SPU board.
Poor discrimination in range	Sea clutter control not functioning properly	Improper setting of A/C SEA. If A/C SEA is seen only at very close range, suspect inaccurate frequency of reference oscillator.

Problem	Possible cause	Remedy
True motion orientation not working correctly	1) Incorrect menu setting 2) Speed entry incorrect 3) TM display inaccurate	1) Referring to section 1.29, select TM orientation mode. 2) Enter correct own ship speed referring to section 1.12. 3) Make sure that speed and compass inputs are accurate.
Target not tracked correctly	Poor definition of targets in sea clutter	Adjust A/C SEA and A/C RAIN referring to section 1.19 and section 1.20.
Buttons on trackball module operated but no response	Trackball module	Replace trackball module.
Picture is not updated with each sweep.	1) Slots in rotating disc in antenna unit 2) Motor brushes	1) Remove foreign material (carbon, grease, etc.) from slots. 2) Replace motor brushes if they are shorter than 6 - 7 mm.

6.7 Diagnostics

A diagnostic test program is provided to test major circuit boards in the control unit, processor unit and card I/F unit. During the test, alerts cannot be acknowledged and the buzzer does not sound. Further, the normal radar picture is not visible. Take extra caution regarding your surroundings when conducting the test.

Proceed as follows to execute the diagnostic test:

1. Open the [MAIN MENU].
2. Select [INITIAL SETTING], then press the **left button**.
3. Select [TEST], then press the **left button**.
4. Select [SELF TEST], then press the **left button**.
5. To stop the test at any time, press the **MENU** key.

In a few moments the results of the test are displayed. The ROMs and RAMs of the SPU, RFC, Control Unit, Trackball Control Unit and SD-Card readers are checked for proper operation. "OK" appears for normal operation. If "NG" (No Good) appears, corresponding components may be defective. Consult your dealer. In the middle of the display the rpm of the antenna unit and various voltages are displayed.

Note: To stop the test, press the **F1** key three times.

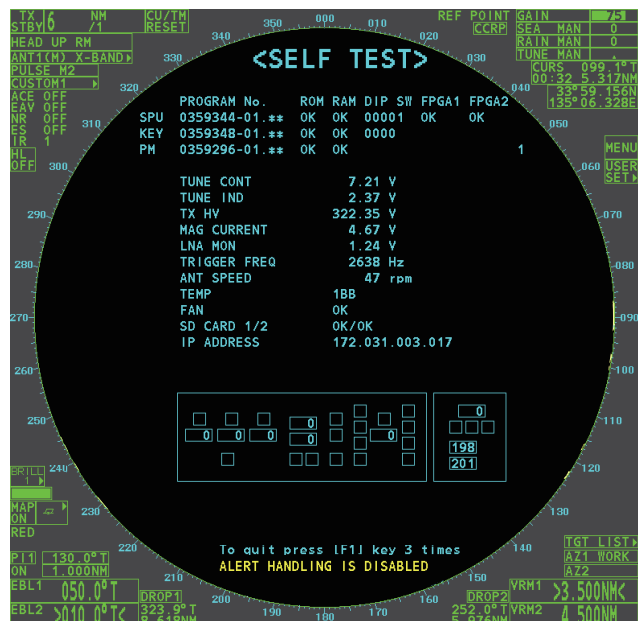

6.8 Fallback Arrangements

If the top priority sensor (for example GPS1) cannot be used, this equipment automatically uses the second priority sensor (for example, GPS2) when multiple sensors (GPS1 and GPS2 for example) are installed. When there is no fallback sensor available, each function is limited as follows:

Sensor	Function limitations
Heading sensor	<ul style="list-style-type: none"> The [HDG] indication reads "****.*°" The orientation mode is automatically set to [HEAD-UP]. TT, AIS, radar map and echo averaging are disabled.
Speed sensor	When [LOG(WT)] is selected: <ul style="list-style-type: none"> The sensor used is automatically switched in the following priority order: GPS(BT) > LOG(BT). The SPD indication reads "****.* kn" when both GPS(BT) and LOG(BT) cannot be used.
	When [LOG(BT)] is selected: <ul style="list-style-type: none"> The sensor used is automatically switched in the following priority order: GPS(BT) > LOG(WT). The SPD indication reads "****.* kn" when both GPS(BT) and LOG(WT) cannot be used.
	When [GPS(BT)] is selected: <ul style="list-style-type: none"> The sensor used is automatically switched in the following priority order: LOG(BT) > LOG(WT). The SPD indication reads "****.* kn" when both LOG(BT) and LOG(WT) cannot be used.
COG/SOG sensor	<ul style="list-style-type: none"> When the GPS sensor cannot be used, the values of COG and SOG are calculated from HDG and LOG(BT). Additionally when the heading sensor cannot be used, the values of SOG is calculated from LOG(BT). The COG indication reads "****.*°".
Position sensor	<ul style="list-style-type: none"> The POSN indication reads all asterisks. AIS and radar map are disabled.

APPX. 1 MENU TREE

MAIN MENU

- └ 1 ECHO
- └ 2 MARK
- └ 3 NAVTOOL
- └ 4 ALERT
- └ 5 TT-AIS
- └ 6 FILES (*1)
- └ 7 INFORMATION BOX
- └ 8 NAV LINE-WPT
- └ 9 INITIAL SETTING

Default settings are displayed in **BOLD ITALIC**.

*1: This menu item is available when a SD-Card is inserted.
When there is no SD-Card inserted, this item is not selectable.

1 ECHO

- └ 1 BACK
- └ 2 2ND ECHO REJ (**OFF**, ON)
- └ 3 TUNE INITIALIZE
- └ 4 PERFORMANCE MON (**OFF**, ON)(*3) (*3): Available when PM is installed.
- └ 5 PM ARC (2, 3, **5**, **6**)(*3)
- └ 6 SART (**OFF**, ON)
- └ 7 ECHO AREA(*2) (**CIRCLE**, WIDE, ALL, SIMPLE) (*2): Available on non-IMO type only
- └ 8 WIPER (**OFF**, 1, 2)
- └ 9 ACE — — — └ 1 BACK
 - └ 2 SIGNAL ENHANCEMENT (1, **2**, 3)
 - └ 3 SUPPRESS SECTOR — └ 1 START (**000**° to 359°)
 - └ 2 ANGLE (**000**° to 180°)
- └ 0 CUSTOM SELECT └ 1 BACK
 - └ 2 CUSTOM1 (**OFF**, ON)
 - └ 3 CUSTOM2 (**OFF**, ON)
 - └ 4 NEAR (**OFF**, ON)
 - └ 5 FAR (**OFF**, ON)
 - └ 6 HEAVY RAIN (**OFF**, ON)
 - └ 7 SHIP (**OFF**, ON)

2 MARK

- └ 1 BACK
- └ 2 OWN SHIP MARK (**MIN**, SCALED)
- └ 3 STERN MARK (**OFF**, ON)
- └ 4 DROP MARK (**OFF**, ON)
- └ 5 BARGE — — — └ 1 BACK
 - └ 2 BARGE MARK (**OFF**, ON)
 - └ 3 BARGE SIZE — — └ 1 LENGTH (**000 ft**, 000 to 999 ft)
 - └ 2 WIDTH (**000 ft**, 000 to 999 ft)
- └ 6 INS MARK — — └ 1 BACK
 - └ 2 USER CHART (**OFF**, ON)
 - └ 3 CURVED EBL (**OFF**, ON)
 - └ 4 CHART SYMBOL (**OFF**, ON)
 - └ 5 NOTE BOOK (**OFF**, ON, DISPLAY)
 - └ 6 ROUTE (**OFF**, CENT, ALL)
 - └ 7 PREDICTOR (**OFF**, ON)
- └ 7 RADAR MAP — └ 1 BACK
 - └ 2 MARK (OFF, **ON**)
 - └ 3 BUOY (OFF, **ON**)
 - └ 4 DANGER (OFF, **ON**)
 - └ 5 COAST LINE (OFF, **ON**)
 - └ 6 CONTOUR LINE (OFF, **ON**)
 - └ 7 NAV LINE (OFF, **ON**)
 - └ 8 PROHIBITED AREA (OFF, **ON**)
- └ 8 OWN TRACK — └ 1 BACK
 - └ 2 DISP OWN TRACK (**OFF**, ON)
 - └ 3 SAVE INTERVAL (OFF, **DRAW ONLY**, 15 s, 30 s, 1 min, 2 min, 3 min, 6 min, 15 min)
 - └ 4 OWN TRACK COLOR (RED, GRN, BLU, YEL, CYA, MAG, **WHT**) (Non-IMO type only)

Continued on next page

Continued from previous page

- └ 5 AIS DISP FILTER — — — — —
 - └ 1 BACK
 - └ 2 SLEEPING TARGET MAX RANGE (**OFF**, ON; 00 NM to 99 NM)
 - └ 3 SLEEPING TARGET MIN SHIP SPEED (**OFF**, ON; 1.0 kn to 9.9 kn)
 - └ 5 BASE STATION (**OFF**, ON)
 - └ 6 PHYSICAL ATON (**OFF**, ON, UNHEALTHY)
 - └ 7 VIRTUAL ATON (**OFF**, ON)
 - Next page
 - └ 1 BACK
 - └ 2 PHYSICAL MATON (**OFF**, ON)
 - └ 3 VIRTUAL MATON (**OFF**, ON)
 - └ 4 SYNTHETIC ATON (**OFF**, ON)
 - └ 5 SAR AIRCRAFT (**OFF**, ON)
 - └ 6 SART (**OFF**, ON)
 - └ 7 SYNTHETIC TARGET (**OFF**, ON)
- └ 6 AIS LOST FILTER — — — — —
 - └ 1 BACK
 - └ 2 MAX RANGE (**OFF**, ON; 00 NM to 99 NM; 12 NM)
 - └ 3 MIN SHIP SPEED (**OFF**, ON; 1.0 kn to 9.9 kn)
 - └ 4 CLASS B (**OFF**, ON)
 - └ 5 ATON (**OFF**, ON)
 - └ 6 SART (**OFF**, ON)
- └ 7 TT LOST FILTER — — — — —
 - └ 1 BACK
 - └ 2 MAX RANGE (**OFF**, ON; 00 NM to 99 NM)
- └ 8 ASSOCIATION — — — — —
 - └ 1 BACK
 - └ 2 ASSOCIATION TGT (**OFF**, AIS, TT)
 - └ 3 GAP (0.000 NM to **0.050 NM**)
 - └ 4 RANGE (0.000 NM to **0.100 NM**)
 - └ 5 BEARING (00.0° to **9.9°**)
 - └ 6 SPEED (0.0 kn to **6.0 kn**)
 - └ 7 COURSE (00.0° to **25.0°**)
- └ 9 TT — — — — —
 - └ 1 BACK
 - └ 2 TARGET NAME FUNCTION (**OFF**, ON)
 - └ 3 TARGET NAME PRESET:
 - └ 1 BACK
 - └ 2 PRESET1 (**BLANK**, User defined preset name)
 - └ 3 PRESET2 (**BLANK**, User defined preset name)
 - └ 4 PRESET3 (**BLANK**, User defined preset name)
 - └ 5 PRESET4 (**BLANK**, User defined preset name)
 - └ 6 PRESET5 (**BLANK**, User defined preset name)
 - └ 0 NEXT
 - └ 1 BACK
 - └ 2 PRESET6 (**BLANK**, User defined preset name)
 - └ 3 PRESET7 (**BLANK**, User defined preset name)
 - └ 4 PRESET8 (**BLANK**, User defined preset name)
 - └ 5 PRESET9 (**BLANK**, User defined preset name)
 - └ 6 PRESET10 (**BLANK**, User defined preset name)

6 FILES*

*: This menu item is available when a SD-Card is inserted.
When there is no SD-Card inserted, this item is not selectable.

- └ 1 BACK
- └ 2 DRIVE SELECT (**SD-1**, SD-2)
- └ 3 SAVE DATA — — — — —
 - └ 1 BACK
 - └ 2 MARK/LINE — — — — —
 - └ 3 SETTING DATA — — — — —
 - └ 4 INSTALL DATA — — — — —
 - └ 1 BACK
 - └ 2 NAME (Software keyboard is displayed for input)
 - └ 5 OWN TRACK — — — — —
 - └ 6 ALERT HISTOR — — — — —
 - └ 7 LOG FILE — — — — —
- └ 4 REPLAY (READ) DATA — — — — —
 - └ 1 BACK
 - └ 2 MARK/LINE — — — — — * (Disabled in TX mode, only available in STBY mode)
 - └ 3 SETTING DATA* — — — — —
 - └ 4 INSTALL DATA* — — — — —
 - └ 1 BACK
 - └ (List of available files is displayed)
 - └ 5 OWN TRACK — — — — —
- └ 5 DELETE DATA — — — — —
 - └ 1 BACK
 - └ 2 MARK/LINE — — — — —
 - └ 3 SETTING DATA — — — — —
 - └ 4 INSTALL DATA — — — — —
 - └ 1 BACK
 - └ NAME (Software keyboard is displayed for input)
 - └ 5 OWN TRACK — — — — —
 - └ 6 ALERT HISTORY — — — — —
 - └ 7 LOG FILE — — — — —
 - └ 8 WPT — — — — —
- └ 6 REMOVE EXTERNAL MEDIA (SD-1, SD-2)

APPX. 1 MENU TREE

7 INFORMATION BOX

- └ 1 BACK
- └ 2 NAVDATA (**OFF**, **ON**)
- └ 3 SET NAVDATA — — └ 1 BACK
 - └ 2 DEPTH (**OFF**, **ON**; *m*, ft)
 - └ 3 DEPTH GRAPH SCALE (**10**, 20, 50, 100, 200, 500)
 - └ 4 DEPTH MARK (**000** TO 500)
 - └ 5 CURRENT (**OFF**, **ON**)
 - └ 6 WIND (**OFF**, **ON**; kn, m/s)
 - └ 7 WIND STAB (**APPARENT**, **NORTH**, **THEORETICAL**)
 - └ 0 NEXT
 - └ 1 BACK
 - └ 2 TEMPERATURE (**OFF**, **ON**; °C, °F)
 - └ 3 WPT DATA (**OFF**, **REL**, **TRUE**)
- └ 4 ZOOM (**OFF**, **2TIMES**, **3TIMES**)
- └ 5 ZOOM DISPLAY (**STAB GND**, **STAB HDG**, **STAB NORTH**, **TT TRACK**)
- └ 6 TARGET DATA (**1BOX**, **2BOX**, **LARGE**)

8 NAV LINE-WPT

- └ 1 BACK
 - └ 2 NAV LINE DATA SOURCE (**OFF**, **EXT DATA**, **WPT MARK**)
 - └ 3 NAV LINE WIDTH (**0.00 NM** to 9.99 NM)
 - └ 4 WPT SET — — └ 1 BACK
 - └ 2 WPT NO. SELECT (01 to 98, default **BLANK**)
 - └ 3 WPT NAME (*1) (*15 chars max*, default **BLANK**)
 - └ 4 WPT L/L
 - └ 5 CLEAR DATA (**YES**, **NO**)
 - └ 5 WPT LIST — — └ 1 BACK
 - └ 0 NEXT
 - └ 6 DISP WPT NO. (**OFF**, **ON**)
 - └ 7 DISP WPT NAME (**OFF**, **ON**)
- (*1) Software keyboard is displayed for input.

9 INITIAL SETTING

- └ 1 BACK
 - └ 2 OPERATIOI — — └ 1 BACK
 - └ 2 WHEEL DRIVE
 - └ 3 KEY BEEP
 - └ 4 OWN SHIP VECTOR
 - └ 5 STERN UP RM
 - └ 6 GUIDANCE (*2)
 - └ 7 SHUTTLE FERRY
 - └ 8 SENSITIVITY
 - └ 3 FUNCTION KEY — — └ 1 BACK
 - └ 2 F1 — — └ 1 BACK
 - └ 2 ECHO — — └ 1 BACK
 - └ 2 CUSTOM-MENU, IR, ES, EAV, NOISE REJ, ANT SELECT, PULSE LENGTH, AUTO-SEA, AUTO-RAIN, TUNE SELECT, 2ND ECHO REJ, PM, SART, ECHO TRAIL, TRAIL T/R, WIPER, ACE, ACE HIGH SENSITIVITY
 - └ 3 STD KEY — — └ 1 BACK
 - └ 2 ALERT ACK, STBY TX, EBL OFFSET, ORIENTATION-MODE, CU-TM RESET, VECTOR TIME, VECTOR MODE, TARGET LIST, BRILL, MARK CURSOR, MARK-OS, MENU, RANGE UP, RANGE DOWN, ACQ, TARGET DATA, TARGET CANCEL
 - └ 4 TT-AIS — — └ 1 BACK
 - └ 2 TT-DISP, AIS-DISP, PAST POSN INTERVAL, REF MARK, CPA LIMIT, CPA, TCPA, AZ1, AZ2, AIS SCALED SYMBOL
 - └ 5 DELETE — — └ 1 BACK
 - └ 2 MARK DELETE, MARK ALL DELETE, OWN TRACK DELETE, OWN TRACK ALL DELETE
 - └ 6 OPERATIOI — — └ 1 BACK
 - └ 2 ECHO AREA, ECHO COLOR, RING(ON/OFF), ZOOM, MOB, ALARM1, ALARM2, TLL, MAP ALIGN
 - └ 3 F2 (same as F1, default **AUTO-SEA**)
 - └ 4 F3 (same as F1, default **ACE HIGH SENSTIVITY**)
 - └ 4 TEST — — — — └ 1 BACK
 - └ 2 SELF TEST
 - └ 3 TT SIMULATION MODE
- (*2): Available on non-IMO type only

BOX MENUS**HDG MENU**

- └ 1 HDG SOURCE (AD-10, **SERIAL**)

SHIP SPEED MENU

- └ 1 SHIP SPEED (LOG(BT), LOG(WT), **GPS**, MANUAL, REF)
- └ 2 MANUAL SPEED (**0.0kn** to 99.9kn)
- └ SET DRIFT (OFF, **ON**)
 - └ (**000.0°** to 359.9°)
 - └ (**0.0kn** to 19.9kn)

LOCAL TIME SETTING

- └ 1 DATE-TIME (**UTC**, LOCAL)
- └ 2 LOCAL TIME ADJUST (-12:00 to +14:00, default: **+00.00**)

OWN SHIP POSN MENU

- └ 1 NAV AID (**GPS1**, GPS2, LAN, INS, DEAD RECKONING)
- └ 2 MANUAL L/L
- └ 3 SIO DATA LAN OUTPUT (**OFF**, ON)

CURSOR MENU

- └ 2 TARGET DATA, ACQ, TARGET CANCEL, TT TGT DATA ACQ, REF MARK, EBL OFFSET, OFF CENTER, ZOOM, MARK DELETE, OWN TRACK DELETE, MAP ALIGN, TRAIL ERASER
- └ 1 BACK
- └ 2 TGT DATA/ACQ SETTING (**ANY**, TT ONLY, AIS ONLY)
- └ 3 TGT CANCEL SETTING (**ANY**, TT ONLY, AIS ONLY)
- └ 4 RANGE RING (OFF, **ON**)
- └ 5 SLEEP ALL TGTS (**NO**, YES)

AIS TARGET MENU

- └ 1 SLEEP ALL TGTS (**NO**, YES)
- └ 2 AUTO DISP MESSAGE (**OFF**, ON)
- └ 3 RECEIVED MESSAGE
- └ 4 TRANSMIT MESSAGE
 - | └ 1 BACK
 - | └ 2 ADDRESS TYPE (**ADDRESSED**, BROADCAST)
 - | └ 3 MESSAGE TYPE (**SAFETY**, BINARY)
 - | └ 4 MMSI NO.
 - | └ 5 CHANNEL (**A**, B, A or B, A and B)
 - | └ 0 NEXT
 - | └ 1 BACK
 - | └ 2 OPEN FILE
 - | └ 3 SAVE FILE
 - | └ 4 EDIT
 - | └ 5 TRANSMIT MESSAGE
- └ 5 VOYAGE DATA
 - | └ 1 BACK
 - | └ 2 NAV STATUS (**00**~15)
 - | └ 3 ETA
 - | └ 4 DESTINATION (Use software keyboard to input up to 20 characters)
 - | └ 5 DRAUGHT (**0.0m**~25.5m)
 - | └ 6 CREW (**0000**~8191)
- └ 6 STATIC DATA
 - | └ 1 BACK
- └ 7 AIS ALM MESSAGES
 - | └ 1 BACK

USER SET

- └ 1 PILOT SETTING (**NO**, YES)
- └ 2 USER 1 LOAD (**NO**, YES)
- └ 3 USER 1 SAVE (**NO**, YES)
- └ 4 USER 2 LOAD (**NO**, YES)
- └ 5 USER 1 SAVE (**NO**, YES)

APPX. 1 MENU TREE

TRAIL MENU

- ┆ 1 TRAIL MODE (**REL**, TRUE)
- ┆ 2 TRAIL GRAD (SINGLE, **MULTI**)
- ┆ 3 TRAIL COLOR (GRN, **BLU**, CYA, MAG, WHT, YEL)
- ┆ 4 TRAIL LEVEL (1, 2, 3, 4)
- ┆ 5 OS TRAIL (**OFF**, 1, 2)
- ┆ 6 NARROW TRAIL (**OFF**, 1, 2) (Non-IMO only)
- ┆ 7 HIDE LAND TRAILS (T) (**OFF**, 1, 2) (Non-IMO only)
- ┆ 8 HIDE LAND TRAILS (R) (**OFF**, 1, 2) (Non-IMO only)

TARGET LIST

- ┆ 1 SORT (**CPA**, TCPA, BCR, BCT, RANGE, SPEED, NAME)

ANT SELECT

- ┆ (Details for the antenna currently in use are displayed here)
- ┆ 9 STORE INTER-SW (**NO**, YES)

CUSTOMIZE ECHO

- ┆ 1 INT REJECT (OFF, 1, 2, 3)
- ┆ 2 ECHO STRETCH (OFF, 1, 2, 3)
- ┆ 3 ECHO AVERAGE (OFF, 1, 2, 3)
- ┆ 4 TARGET ANALYZER (**OFF**, ON) (Non-IMO only)
- ┆ 5 HATCHING (**OFF**, ON) (Non-IMO only)
- ┆ 6 NOISE REJECT (**OFF**, ON)
- ┆ 7 VIDEO CONTRACT TYPE (1, 2, 3, 4) (A, B, C)
- ┆ 8 PULSE
 - | ┆ 1 BACK
 - | ┆ 2 0.125NM (**S1**, S2)
 - | ┆ 3 0.25NM (**S1**, S2)
 - | ┆ 4 0.5NM (**S1**, S2)
 - | ┆ 5 0.75NM (**S1**, S2, M1, M2)
 - | ┆ 6 1NM (**S1**, S2, M1, M2)
 - | ┆ 7 1.5NM (**S1**, S2, M1, M2)
 - | ┆ 8 2NM (**S1**, S2, M1, M2)
 - | ┆ 9 3NM (S1, **S2**, M1, M2, M3)
 - | ┆ 0 NEXT
 - | ┆ 1 BACK
 - | ┆ 2 4NM (**S2**, M1, M2, M3, L)
 - | ┆ 3 6NM (S2, M1, **M2**, M3, L)
 - | ┆ 4 8NM (M1, **M2**, M3, L)
 - | ┆ 5 12NM (M1, M2, **M3**, L)
 - | ┆ 6 16NM (M1, M2, **M3**, L)
 - | ┆ 7 24NM (M1, M2, M3, L)
- ┆ 9 CONDITION
 - | ┆ 1 BACK
 - | ┆ 2 NEAR STC CURVE (2, 2.5, 3, 3.5, 4.2)
 - | ┆ 3 STC ANT HEIGHT (5, 7.5, 10, 15, 20, **25**, 30, 35, 40, 45, over50m)
 - | ┆ LOW LEVEL ECHO (**0~8**)
- ┆ 0 NEXT
- ┆ 1 BACK
- ┆ 2 DEFAULT (**NO**, SAVE, USER, FACTORY)
- ┆ 3 ACE (**OFF**, ON)

BRILL1 (2, 3, 4) MENU

- ┆ 1 ECHO COLOR (**YEL**, GRN, WHT, AMB, M-GRN, M-CYA,)
- ┆ 2 PALETTE* (**DAY-GRY**, DAY-BLU, DUSK-GRY, DUCK-BLU, NIGHT-GRY, NIGHT-BLU)
- ┆ 3 CONTROL PANEL
- ┆ 4 CHARACTER
- ┆ 5 CURSOR
- ┆ 6 ECHO
- ┆ 7 TRAIL
- ┆ 8 HL
- ┆ 9 RING
- ┆ 0 NEXT

*:FACTORY DEFAULT SETTINGS

BRILL2 : **DAY-BLU**

BRILL3 : **DUSK-BLU**

BRILL4 : **NIGHT-GRY**

MARK MENU

- ┆ 1 ORIGIN MARK STAB (**GND**, SEA)
- ┆ 2 MARK KIND (ORIGIN MARK(No.), ORIGIN MARK(SYM), **MAP MARK**, WP 1~50, WP 51~98)
- ┆ 3 MARK POSITION (**CURSOR**, OS, L/L)
- ┆ 0 NEXT
- ┆ 1 BACK
- ┆ 2 MAP DISPLAY (OFF, **ON**)
- ┆ 3 MARK COLOR (RED, GRN, BLU, YEL, CYA, MAG, **WHT**)

APPX. 2 LONGITUDE ERROR TABLE (96 NM SCALE)

The longitude lines concentrate on the north pole and south pole, namely, 1 nm is equivalent to 1 minute at 0 degree latitude, 2 minutes at 60 degrees latitude, 3 minutes at 70 degrees latitude and so on. For this reason, a longitude error occurs on the radar display.

For example, when own ship is at 60°N and 135°E, even if the cursor indication is 62°N and 139°E, the real cursor position is deviated to the left (west) side. The table below shows the longitude error, represented from 0° to 90° at 96 nm from the radar center (own ship).

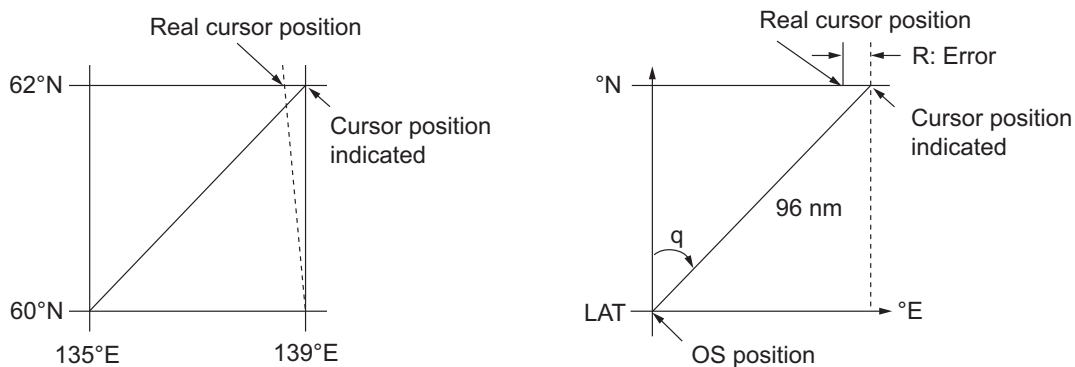

(nm)

LAT \ q	5°	10°	15°	20°	25°	30°	35°	40°	45°
75°	0.2256	0.4444	0.6496	0.8350	0.9950	1.1248	1.2202	1.2786	1.2980
70°	0.21980213	0.43290201	0.632803	0.8134132	0.96923215	1.09551918	1.1884382	1.24517456	1.26402037
65°	0.21229339	0.41810678	0.61115946	0.78556318	0.93600295	1.05790007	1.14755221	1.20224625	1.22034042
60°	0.20316898	0.40012949	0.58486463	0.75173456	0.89565021	1.0122297	1.09793265	1.15016811	1.16737294
55°	0.19249832	0.37910698	0.55411863	0.71218478	0.84848102	0.95885565	1.03998717	1.08933651	1.10552105
50°	0.18036264	0.35519924	0.51915545	0.66721485	0.79485438	0.89818413	0.97406698	1.02021439	1.03525547
45°	0.16685429	0.32858822	0.48024119	0.61716701	0.73517843	0.83067689	0.90076355	0.94332783	0.95711098
40°	0.15207608	0.29947644	0.437672	0.56242216	0.66990732	0.7568477	0.82060477	0.85926197	0.87168229
35°	0.13614047	0.26808546	0.39177186	0.53339693	0.59953781	0.67725844	0.73420069	0.76865661	0.77961957
30°	0.11916876	0.2346542	0.3428901	0.44054055	0.52460545	0.59251483	0.6422089	0.67220131	0.68162348
25°	0.10129001	0.19943707	0.29139874	0.37433139	0.44568053	0.50326182	0.54532952	0.57063015	0.57843983
20°	0.08264056	0.16270211	0.23768966	0.30527334	0.36336372	0.41017869	0.44429984	0.46471615	0.47085389
15°	0.06336208	0.12472888	0.18217162	0.23389198	0.27828148	0.31397386	0.33988878	0.35526538	0.35968447
10°	0.04360137	0.0858064	0.12526714	0.16073056	0.19108136	0.21537949	0.23289096	0.24311083	0.24577764
5°	0.02350833	0.04623087	0.0674093	0.08634588	0.10242699	0.11514595	0.1241207	0.12910605	0.13000029
0°	0.00323737	0.0063035	0.00903844	0.01130406	0.01299309	0.01403609	0.0144058	0.0141187	0.01323356

APPX. 2 LONGITUDE ERROR TABLE (96 NM SCALE)

(nm)

LAT \ q	50°	55°	60°	65°	70°	75°	80°	85°	90°
75°	1.2780	1.2192	1.1233	0.9933	0.8332	0.6479	0.4431	0.2249	0
70°	1.24442563	1.18701379	1.09356117	0.96694117	0.81103484	0.3061092	0.43117887	0.21881975	0
65°	1.20131324	1.14577786	1.05546143	0.93315023	0.78260251	0.60843159	0.41596331	0.21107193	0
60°	1.14905813	1.09582188	1.00932899	0.89225746	0.74821409	0.58162173	0.397582	0.20171772	0
55°	1.08805799	1.03752602	0.95551494	0.84457408	0.70813132	0.55038538	0.37617487	0.19082831	0
50°	1.0187708	0.97133397	0.89442885	0.79046297	0.66265924	0.51496026	0.35190481	0.17848659	0
45°	0.94174265	0.89774948	0.82653562	0.73033596	0.61214392	0.47561599	0.32495654	0.16478648	0
40°	0.85754099	0.81733258	0.75235195	0.66465066	0.55696981	0.43265198	0.29553516	0.14983224	0
35°	0.76681293	0.73069528	0.63744242	0.59390696	0.49755683	0.38639524	0.26386458	0.13373769	0
30°	0.67024897	0.63849695	0.58741521	0.51864327	0.43435714	0.33719779	0.23018583	0.11662531	0
25°	0.568584	0.54143927	0.49791741	0.43943239	0.36785173	0.28543407	0.19475522	0.09862535	0
20°	0.46259176	0.44026091	0.40463016	0.35687717	0.29854675	0.23149802	0.15784242	0.07987479	0
15°	0.35307892	0.3357319	0.30826343	0.2716059	0.22696965	0.17580013	0.11972833	0.06051633	0
10°	0.2487894	0.22864776	0.20955062	0.18426754	0.15366517	0.1187643	0.08070304	0.0406973	0
5°	0.12684572	0.11982348	0.10624302	0.09552679	0.0791912	0.04106355	0.04106355	0.02056855	0
0°	0.01184713	0.01008727	0.008104	0.00605903	0.00411455	0.00111154	0.00111154	0.00028325	0

APPX. 3 ALERT CODES, MESSAGES AND MEANINGS

This radar provides aggregated header alerts for presentation of an aggregation on the AMS (Alert Management System). The following table shows the aggregate header alerts along with the corresponding ALF alert number.

Aggregate Header Alert	ALF No.*	Aggregate Header Alert	ALF No.*
TARGET CAPACITY	3042,x	TARGET CAPACITY	3043,x
LOST TARGET	3052,x	NEW TARGET	3048,x
LOST SIGNAL	3015,x	LOST RADAR FUNC	3008,x
WRONG SETTING	3019,x	LOST SIGNAL	3016,x

*: "x" indicates instance number.

The following table lists the possible alerts for this equipment. Each alert is listed with priority and category. This equipment can output alerts in ALF or ALR format. The alert number depends on the output format and may differ between formats.

Note: Highlighted alerts have no aggregated alert name.

ALF format alerts

Alert ID	Alert title	Message	Priority & Category
3043,1	TT TGT 95%(AUTO)	Message: "CANCEL NON-DANGEROUS TARGETS MANUALLY"	Caution Cat: A*1
	Meaning: Automatically acquired target capacity has reached 95%. Remedy: Press the ALERT ACK key. Remove TT symbols manually.		
3042,1	TT TGT FULL(AUTO)	Message: "CANCEL NON-DANGEROUS TARGETS MANUALLY"	Warning Cat: A
	Meaning: Automatically acquired target capacity has reached 100%. Remedy: Press the ALERT ACK key. Remove TT symbols manually.		
3043,2	TT TGT 95%(MAN)	Message: "CANCEL NON-DANGEROUS TARGETS MANUALLY"	Caution Cat: A*1
	Meaning: Manually acquired target capacity has reached 95%. Remedy: Press the ALERT ACK key. Remove TT symbols manually.		
3042,2	TT TGT FULL(MAN)	Message: "CANCEL NON-DANGEROUS TARGETS MANUALLY"	Warning Cat: A
	Meaning: Manually acquired target capacity has reached 100%. Remedy: Press the ALERT ACK key. Remove TT symbols manually.		
3043,3	AIS DISPLAY 95%	Message: "ADJUST [AIS DISP FILTER] SETTINGS"	Caution Cat: A*1
	Meaning: AIS display capacity has reached 95% (285 targets). Remedy: Press the ALERT ACK key. Adjust [AIS DISP FILTER] settings to decrease the number of targets displayed.		
3042,3	AIS DISPLAY FULL	Message: "ADJUST [AIS DISP FILTER] SETTINGS"	Warning Cat: A
	Meaning: AIS display capacity has reached 100% (300 targets). Remedy: Press the ALERT ACK key. Adjust [AIS DISP FILTER] settings to decrease the number of targets displayed.		

Alert ID	Alert title	Message	Priority & Category
3043,4	AIS CPTY 95%	Message: "ADJUST [AIS DISP FILTER] SETTINGS"	Caution Cat: A*1
	Meaning: AIS capacity has reached 95% (950 targets). Remedy: Press the ALERT ACK key. Adjust [AIS DISP FILTER] settings to decrease the number of targets displayed.		
3042,4	AIS CPTY FULL	Message: "ADJUST [AIS DISP FILTER] SETTINGS"	Warning Cat: A
	Meaning: AIS capacity has reached 100% (1000 targets). Remedy: Press the ALERT ACK key. Adjust [AIS DISP FILTER] settings to decrease the number of targets displayed.		
3043,5	AIS CPTY FULL	Message: "ADJUST [AIS DISP FILTER] SETTINGS"	Cat: A*1 Warning
	Meaning: AIS capacity has reached 100% (1000 targets). Remedy: Press the ALERT ACK key. Adjust [AIS DISP FILTER] settings to decrease the number of targets displayed.		
3043,6	ACTIVE AIS 95%	Message: "SLEEP NON-DANGEROUS TARGETS MANUALLY"	Caution Cat: A*1
	Meaning: Active AIS target capacity has reached 95% (38 targets). Remedy: Press the ALERT ACK key. Sleep all unnecessary AIS targets.		
3043, 7	AIS DATREP FULL	Message: "ADJUST [AIS DISP FILTER] SETTINGS"	Cat: B Caution
	Meaning: AIS data report capacity has reached 100% (50 objects). Remedy: Press the ALERT ACK key. Adjust [AIS DISP FILTER] settings to decrease the number of objects displayed.		
3043, 8	AIS SART FULL	Message: "ADJUST [AIS DISP FILTER] SETTINGS"	Caution Cat: B
	Meaning: AIS locating device capacity has reached 100% (20 objects). Remedy: Press the ALERT ACK key. Adjust [AIS DISP FILTER] settings to decrease the number of objects displayed.		
3043, 9	AIS SYN TGT FULL	Message: "ADJUST [AIS DISP FILTER] SETTINGS"	Caution Cat: B
	Meaning: AIS synthetic target capacity has reached 100% (50 objects). Remedy: Press the ALERT ACK key. Adjust [AIS DISP FILTER] settings to decrease the number of objects displayed.		
3042,5	ACTIVE AIS FULL	Message: "SLEEP NON-DANGEROUS TARGETS MANUALLY"	Warning Cat: A
	Meaning: Active AIS target capacity has reached 100% (40 targets). Remedy: Press the ALERT ACK key. Sleep all unnecessary AIS targets.		
3044	CPA/TCPA	Message: "TAKE EVASIVE ACTION IF NECESSARY"	Alarm Cat: A
	Meaning: Target is within CPA/TCPA threshold, danger of collision. Remedy: Press the ALERT ACK key. Take evasive action if necessary. Adjust CPA/TCPA settings.		
3048,1	TT NEW TARGET	Message: "CONFIRM TT NEW TARGETS"	Warning Cat: A
	Meaning: A new TT target has entered the Acquisition Zone. Remedy: Press the ALERT ACK key. Confirm location of new target.		
3048,2	AIS NEW TARGET	Message: "CONFIRM AIS NEW TARGETS"	Warning Cat: A
	Meaning: A new AIS target has entered the Acquisition Zone. Remedy: Press the ALERT ACK key. Confirm location of new target.		

APPX. 3 ALERT CODES, MESSAGES AND MEANINGS

Alert ID	Alert title	Message	Priority & Category
3052,1	TT TARGET LOST	Message: "CHECK LOST TGT. ACQ TARGET IF NECESSARY"	Warning Cat: A
	Meaning: TT target is lost. Remedy: Press the ALERT ACK key. Lost target indication (blinking in red) is removed.		
3052,2	REF TARGET LOST	Message: "CHECK LOST TGT. ACQ TARGET IF NECESSARY"	Warning Cat: A
	Meaning: REF targets is lost. Remedy: Press the ALERT ACK key. Lost target indication (blinking in red) is removed.		
3052,3	AIS TARGET LOST	Message: "CONFIRM AIS LOST TARGETS"	Warning Cat: A
	Meaning: AIS target is lost. Remedy: Press the ALERT ACK key. Lost target indication (blinking in red) is removed.		
3052,4	AIS ATON LOST	Message: "CONFIRM AIS LOST ATONS"	Warning Cat: A
	Meaning: AIS AtoN (Aids to Navigation) data is not input for a certain period of time (Lost AtoN). Remedy: Press the ALERT ACK key. Reacquire if necessary.		
3052,5	AIS SART LOST	Message: "CONFIRM AIS LOST LOCATING DEVICES"	Warning Cat: A
	Meaning: AIS SART, AIS MOB, EPIRB-AIS data is not input for a certain period of time (Lost SART). Remedy: Press the ALERT ACK key. Reacquire if necessary.		
3003	AIS MSG SEND ERR	Message: "UNABLE TO TRANSMIT AIS Message. CHECK AIS"	Caution Cat: B
	Meaning: Unable to transmit AIS message. Remedy: Press the ALERT ACK key. Check power to AIS unit.		
3008,1	LOST ISW FUNC	Message: "USE RADAR AS STAND-ALONE"	Warning Cat: B
	Meaning: Interswitch function had to be stopped. Remedy: Press the ALERT ACK key. Use the radar as a standalone.		
3015,1	LOST HEADLINE	Message: "EXECUTE THE DIAGNOSTIC TEST"	Warning Cat: B
	Meaning: Heading marker signal interrupted/lost. Remedy: Press the ALERT ACK key. Restore signal or rectify reason for signal loss.		
3015,2	LOST AZIMUTH SIG	Message: "EXECUTE THE DIAGNOSTIC TEST"	Warning Cat: B
	Meaning: Antenna signal is interrupted/lost. Remedy: Press the ALERT ACK key. Restore signal or rectify reason for signal loss.		
3015,3	LOST TRIGGER SIG	Message: "EXECUTE THE DIAGNOSTIC TEST"	Warning Cat: B
	Meaning: Antenna trigger interrupted/lost Remedy: Press the ALERT ACK key. Restore signal or rectify reason for signal loss.		
3015,4	LOST VIDEO SIG	Message: "EXECUTE THE DIAGNOSTIC TEST"	Warning Cat: B
	Meaning: Video signal interrupted/lost. Remedy: Press the ALERT ACK key. Restore signal or rectify reason for signal loss.		
3015,5	LOST CTRL UNIT	Message: "CHECK CONNECTION WITH CONTROL UNIT"	Warning Cat: B
	Meaning: Control unit RCU-028 signal interrupted/lost. Remedy: Press the ALERT ACK key. Restore signal or rectify reason for signal loss.		

Alert ID	Alert title	Message	Priority & Category
3015,6	LOST TUNE IND	Message: "INITIALIZE TUNING AGAIN"	Warning Cat: B
	Meaning: TUNE error due to faulty settings or malfunction. Remedy: Press the ALERT ACK key. Restore signal or rectify reason for signal loss.		
3015,20	LOST GYRO SIGNAL	Message: "CHECK HEADING SENSOR OR SENTENCE MONITOR"	Warning Cat: B
	Meaning: No heading information received from gyrocompass for five seconds. Remedy: Press the ALERT ACK key. Check the connection with the gyrocompass.		
3015,21	LOST LOG(WT) SIG	Message: "CHECK SPEED SENSOR OR SENTENCE MONITOR"	Warning Cat: B
	Meaning: No speed through water data received for five seconds when [LOG(WT)] is set as speed reference. Remedy: Press the ALERT ACK key. Check SDME sensor. Use a different sensor if necessary.		
3015,22	LOST LOG(BT) SIG	Message: "CHECK SPEED SENSOR OR SENTENCE MONITOR"	Warning Cat: B
	Meaning: No speed over ground data received for thirty seconds when [LOG(BT)] is set as speed reference. Remedy: Press the ALERT ACK key. Check SDME sensor. Use a different sensor if necessary.		
3015,23	LOST POSITION	Message: "CHECK POSITION SENSOR OR SENTENCE MONITOR"	Warning Cat: B
	Meaning: EPFS Error. No position data received from EPFS device for thirty seconds. Remedy: Press the ALERT ACK key. Restore the signal. This indication cannot be erased if the position signal is missing. The indication is automatically removed when the signal is restored.		
3015,24	LOST DATUM	Message: "CHECK POSITION SENSOR OR SENTENCE MONITOR"	Warning Cat: B
	Meaning: DTM sentence not received for thirty seconds, or erroneous data received. Remedy: Press the ALERT ACK key. Use the WGS-84 datum.		
3015,25	LOST UTC SIGNAL	Message: "CHECK POSITION SENSOR OR SENTENCE MONITOR"	Warning Cat: B
	Meaning: UTC error. No date or time data received for thirty seconds. No ZDA sentence input. Remedy: Press the ALERT ACK key. Restore the signal to remove this indication.		
3015,26	LOST AIS COM	Message: "CHECK AIS OR SENTENCE MONITOR"	Warning Cat: B
	Meaning: No AIS data received for thirty seconds. Remedy: Press the ALERT ACK key. Check power and connection to AIS unit.		
3015,27	LOST COG/SOG SIG	Message: "CHECK POSITION SENSOR OR SENTENCE MONITOR"	Warning Cat: B
	Meaning: EPFS Error. No COG/SOG data received from EPFS device for thirty seconds when [EPFS] is set as speed reference. Remedy: Press the ALERT ACK key. Restore the signal. This indication cannot be erased if the COG/SOG signal is missing. The indication is automatically removed when the signal is restored.		
3016,13	LOST PM BOARD	Message: "EXECUTE THE DIAGNOSTIC TEST"	Caution Cat: B
	Meaning: The signal between the antenna's SPU and PM was interrupted/lost. Remedy: Press the ALERT ACK key. Restore signal or rectify reason for signal loss.		

APPX. 3 ALERT CODES, MESSAGES AND MEANINGS

Alert ID	Alert title	Message	Priority & Category
3016,21	LOST LOG(WT) SIG	Message: "CHECK SPEED SENSOR OR SENTENCE MONITOR"	Caution Cat: B
	Meaning: No speed through water data received for five seconds when [LOG(WT)] is set as speed reference. Remedy: Press the ALERT ACK key. Check SDME sensor. Use a different sensor if necessary.		
3016,22	LOST LOG(BT) SIG	Message: "CHECK SPEED SENSOR OR SENTENCE MONITOR"	Caution Cat: B
	Meaning: No speed over ground data received for thirty seconds when [LOG(BT)] is set as speed reference. Remedy: Press the ALERT ACK key. Check SDME sensor. Use a different sensor if necessary.		
3016,26	LOST AIS COM	Message: "CHECK AIS OR SENTENCE MONITOR"	Caution Cat: B
	Meaning: No AIS data received for thirty seconds. Remedy: Press the ALERT ACK key. Check power and connection to AIS unit.		
3016,27	LOST COG/SOG SIG	Message: "CHECK POSITION SENSOR OR SENTENCE MONITOR"	Caution Cat: B
	Meaning: EPFS Error. No COG/SOG data received from EPFS device for thirty seconds when [EPFS] is set as speed reference. Remedy: Press the ALERT ACK key. Restore the signal. This indication cannot be erased if the COG/SOG signal is missing. The indication is automatically removed when the signal is restored.		
3019,1	SYSTEM ERROR	Message: "CHECK IP SETTINGS AND ASSIGN A UNIQUE IP"	Caution Cat: B
	Meaning: LAN1 IP address is in use by other equipment. Remedy: Press the ALERT ACK key. Check the IP settings and assign a unique IP address.		
3032	ANCHOR WATCH	Message: "CONFIRM OWN SHIP LOCATION"	Warning Cat: B
	Meaning: Ship position outside set anchor watch zone. Remedy: Press the ALERT ACK key. Confirm Own Ship location and adjust as necessary.		
51782	ARRIVED AT WPT* ³	Message: "SET NEXT WPT, IF NECESSARY"	Warning Cat: B
	Meaning: Ship has entered the destination arrival alert zone. Remedy: Press the ALERT ACK key. No other action required.		
51785	XTD LIM EXCEEDED* ³	Message: "CHECK COURSE AND ADJUST AS NECESSARY"	Warning Cat: B
	Meaning: Cross-track error, ship is off-course. Remedy: Press the ALERT ACK key. Check course and adjust as necessary.		
51602,1	SOURCE CHANGE	Message: "POSN SOURCE CHG"	Caution Cat: B
	Meaning: Positioning sensor input lost, automatically changed sensors. Remedy: Press the ALERT ACK key. The indication is automatically removed when the signal is restored or a different sensor is selected.		
51602,2	SOURCE CHANGE	Message: "SPD SOURCE CHG"	Caution Cat: B
	Meaning: Speed sensor input lost, automatically changed sensors. Remedy: Press the ALERT ACK key. The indication is automatically removed when the signal is restored or a different sensor is selected.		

Alert ID	Alert title	Message	Priority & Category
51740,1	EXT RADAR ERROR	Message: "EXT RADAR NO SIGNAL"	Warning Cat: B
	Meaning: Selected radar has an error (HEADLINE, AZIMUTH, TRIGGER, VIDEO, TUNE ERROR). Only displayed when Interswitch is active. Remedy: Press the ALERT ACK key. Restore the external radar to normal operating condition.		
51740,2	EXT RADAR ERROR	Message: "EXT RADAR COM ERROR"	Warning Cat: B
	Meaning: Communication with external radar interrupted or lost. (Only displayed when Interswitch is active.) Remedy: Press the ALERT ACK key. Check connection and power to the external radar.		
51950,1	BAM COM ERROR* ²	Message: "COMMUNICATION ERROR WITH BAM"	Warning Cat: B
	Meaning: Communication with the Bridge Alert Management System interrupted. Remedy: Press the ALERT ACK key. Check connection to BAM. Check power to BAM.		

*1: When [TYPE] is set to [R], the category for this alert is set to B.

*2: This alert is output only when [TYPE] is set to [R].

*3: This alert is output only when [TYPE] is set to [Non-IMO].

ALF format indications

The following indications are shown by this equipment when ALF format is in use. These indications have no category, are not subject to responsibility transfer and are not output as ALF sentences.

Note: Indications also appear in the ALERT BOX on the screen and on the ALERT LIST.

ID	Title	Meaning	Remedy
51602,1	POSN SOURCE CHG	Positioning sensor input lost, automatically changed sensors.	Press the ALERT ACK key. The indication is automatically removed when the signal is restored or a different sensor is selected.
51602,2	SPD SOURCE CHG	speed sensor input lost, automatically changed sensors.	
51740,1	ISW: NO SIGNAL Message: "Selected radar has problem. Use radar as standalone."	Selected radar has an error. (Only displayed when Interswitch is active.)	Press the ALERT ACK key. Use radar as standalone or restore the external radar to normal operating condition.
51740,2	ISW: NO RADAR Message: "Communication with selected radar has interrupted/lost. Use radar as standalone."	Communication with selected radar is interrupted or lost. (Only displayed when Interswitch is active.)	Press the ALERT ACK key. Use radar as standalone or check connection and power to the external radar.
51740,3	ISW: STBY Message: "Selected radar entered standby mode. Set selected radar to TX mode."	Selected radar has entered standby mode.	Press the ALERT ACK key. Check transmission status of the selected radar.

ID	Title	Meaning	Remedy
51740,4	ISW: NO SENSOR Message: "Selected radar has problem. Use radar as standalone."	No heading data was received from the selected radar for more than five seconds.	Press the ALERT ACK key. Check heading data input status for the selected radar.

ALR format alerts

The following critical alerts cannot be acknowledged from external equipment and must be acknowledged from the radar itself. (• TT COLLISION • AIS COLLISION)

Alert code	Alert title	Explanation	Priority & Category
523	TT TGT FULL(AUTO)	Automatically acquired target capacity has reached 100%.	Warning Cat: A
	Remedy: Press the ALERT ACK key. Remove TT symbols manually.		
525	TT TGT FULL(MAN)	Manually acquired target capacity has reached 100%.	Warning Cat: A
	Remedy: Press the ALERT ACK key. Remove TT symbols manually.		
531	AIS DISPLAY FULL	AIS display capacity has reached 100% (300 targets).	Warning Cat: A
	Remedy: Press the ALERT ACK key. Adjust [AIS DISP FILTER] settings to decrease the number of targets displayed.		
533	AIS CPTY FULL	AIS capacity has reached 100% (1200 targets).	Warning Cat: A
	Remedy: Press the ALERT ACK key. Adjust [AIS DISP FILTER] settings to decrease the number of targets displayed.		
535	ACTIVE AIS FULL	Active AIS target capacity has reached 100% (40 targets).	Warning Cat: A
	Remedy: Press the ALERT ACK key. Sleep all unnecessary targets.		
522* ²	TT TGT 95%(AUTO)	Automatically acquired target capacity has reached 95%.	Caution Cat: B
	Remedy: Press the ALERT ACK key. Remove TT symbols manually.		
524*	TT TGT 95% (MAN)	Manually acquired target capacity has reached 95%	Caution Cat: B
	Remedy: Press the ALERT ACK key. Remove TT symbols manually.		
530* ²	AIS DISPLAY 95%	AIS display capacity has reached 95% (950 targets).	Caution Cat: B
	Remedy: Press the ALERT ACK key. Adjust [AIS DISP FILTER] settings to decrease the number of targets displayed.		
532* ²	AIS CPTY 95%	AIS display capacity has reached 95% (950 targets).	Caution Cat: B
	Remedy: Press the ALERT ACK key. Adjust [AIS DISP FILTER] settings to decrease the number of targets displayed.		
533* ²	AIS CPTY FULL	AIS capacity has reached 100% (1000 targets).	Warning Cat: A
	Remedy: Press the ALERT ACK key. Adjust [AIS DISP FILTER] settings to decrease the number of targets displayed.		
534* ²	ACTIVE AIS 95%	Active AIS target capacity has reached 95% (38 targets).	Caution Cat: B
	Remedy: Press the ALERT ACK key. Sleep all unnecessary targets.		

Alert code	Alert title	Explanation	Priority & Category
541	AIS MSG SEND ERR	Message: "UNABLE TO TRANSMIT AIS Message. CHECK AIS"	Caution Cat: B
	Meaning: Unable to transmit AIS message. Remedy: Press the ALERT ACK key. Check power to AIS unit.		
800	AIS DATREP FULL	Message: "ADJUST [AIS DISP FILTER] SETTINGS"	Caution Cat: B
	Meaning: AIS data report capacity has reached 100% (50 objects). Remedy: Press the ALERT ACK key. Adjust [AIS DISP FILTER] settings to decrease the number of objects displayed.		
801	AIS SART FULL	Message: "ADJUST [AIS DISP FILTER] SETTINGS"	Caution Cat: B
	Meaning: AIS locating device capacity has reached 100% (20 objects). Remedy: Press the ALERT ACK key. Adjust [AIS DISP FILTER] settings to decrease the number of objects displayed.		
802	AIS SYN TGT FULL	Message: "ADJUST [AIS DISP FILTER] SETTINGS"	Caution Cat: B
	Meaning: AIS synthetic target capacity has reached 100% (50 objects). Remedy: Press the ALERT ACK key. Adjust [AIS DISP FILTER] settings to decrease the number of objects displayed.		
804	AIS ATON LOST	Message: "CONFIRM AIS LOST ATONS"	Warning Cat: A
	Meaning: AIS AtoN (Aids to Navigation) data is not input for a certain period of time (Lost AtoN). Remedy: Press the ALERT ACK key. Reacquire if necessary.		
805	AIS SART LOST	Message: "CONFIRM AIS LOST SARTS"	Warning Cat: A
	Meaning: AIS SART, AIS MOB, EPIRB-AIS data is not input for a certain period of time (Lost SART). Remedy: Press the ALERT ACK key. Reacquire if necessary.		
516	CPA/TCPA	Target is within CPA/TCPA threshold, danger of collision.	Alarm Cat: A
	Remedy: Press the ALERT ACK key. Take evasive action if necessary. Adjust CPA/TCPA settings.		
521	TT NEW TARGET	A new TT target has entered the Acquisition Zone.	Warning Cat: A
	Remedy: Press the ALERT ACK key. Confirm location of new target.		
529	AIS NEW TARGET	A new AIS target has entered the Acquisition Zone.	Warning Cat: A
	Remedy: Press the ALERT ACK key. Confirm location of new target.		
527	TT TARGET LOST	TT target is lost.	Warning Cat: A
	Remedy: Press the ALERT ACK key. Lost target indication (blinking in red) is removed.		
528	REF TARGET LOST	REF targets is lost.	Warning Cat: A
	Remedy: Press the ALERT ACK key. Lost target indication (blinking in red) is removed.		
537	AIS TARGET LOST	AIS target is lost.	Warning Cat: A
	Remedy: Press the ALERT ACK key. Lost target indication (blinking in red) is removed.		
541*2	AIS MSG SEND ERR	Unable to transmit AIS binary message.	Caution Cat: B
	Remedy: Press the ALERT ACK key. Check power and connection to AIS unit.		

APPX. 3 ALERT CODES, MESSAGES AND MEANINGS

Alert code	Alert title	Explanation	Priority & Category
740	LOST ISW FUNCTION	Interswitch function had to be stopped. (Only displayed when Interswitch is active.)	Warning Cat: B
	Remedy: Press the ALERT ACK key. Use the radar as standalone.		
720	LOST HEADLINE	Heading marker signal interrupted/lost.	Warning Cat: B
	Remedy: Press the ALERT ACK key. Restore signal or rectify reason for signal loss.		
721	LOST AZIMUTH SIG	Antenna signal is interrupted/lost.	Warning Cat: B
	Remedy: Press the ALERT ACK key. Restore signal or rectify reason for signal loss.		
722	LOST TRIGGER SIG	Antenna trigger interrupted/lost	Warning Cat: B
	Remedy: Press the ALERT ACK key. Restore signal or rectify reason for signal loss.		
723	LOST VIDEO SIG	Video signal interrupted/lost.	Warning Cat: B
	Remedy: Press the ALERT ACK key. Restore signal or rectify reason for signal loss.		
70	LOST CTRL UNIT	Control unit RCU-028 signal interrupted/lost.	Warning Cat: B
	Remedy: Press the ALERT ACK key. Restore signal or rectify reason for signal loss.		
48	LOST TUNE IND	TUNE error due to faulty settings or malfunction.	Warning Cat: B
	Remedy: Press the ALERT ACK key. Check tuning settings and adjust as necessary.		
450	LOST GYRO SIGNAL	No heading information received from gyrocompass for five seconds.	Warning Cat: B
	Remedy: Press the ALERT ACK key. Check the connection with the gyrocompass.		
278	LOST LOG(WT) SIG	No speed data received for five seconds when [LOG(WT)] is set as speed reference.	Warning/ Caution Cat: B
	Remedy: Press the ALERT ACK key. Check SDME sensor. Use a different sensor if necessary.		
284	LOST LOG(BT) SIG	No speed data received for thirty seconds when [LOG(BT)] is set as speed reference.	Warning/ Caution Cat: B
	Remedy: Press the ALERT ACK key. Check SDME sensor. Use a different sensor if necessary.		
170	LOST POSITION	EPFS Error. No position data received from EPFS device for thirty seconds.	Warning Cat: B
	Remedy: Press the ALERT ACK key. Restore the signal. This indication cannot be erased if the position signal is missing. The indication is automatically removed when the signal is restored.		
469	LOST DATUM	DTM sentence not received for thirty seconds or erroneous data received.	Warning Cat: B
	Remedy: Press the ALERT ACK key. Use the WGS-84 datum.		
272	LOST UTC SIGNAL	UTC error. No date or time data received for thirty seconds.	Warning Cat: B
	Remedy: Press the ALERT ACK key. Restore the signal to remove this indication.		
380	LOST AIS COM	No AIS data received for thirty seconds.	Warning Cat: B
	Remedy: Press the ALERT ACK key. Check power and connection to AIS unit.		

Alert code	Alert title	Explanation	Priority & Category
279	LOST COG/SOG SIG	Meaning: EPFS Error. No COG/SOG data received from EPFS device for thirty seconds.	Warning Cat: B
	Remedy: Press the ALERT ACK key. Restore the signal. This indication cannot be erased if the COG/SOG signal is missing. The indication is automatically removed when the signal is restored.		
782*2	LOST PM BOARD	Signal between antenna's SPU and PM interrupted/lost.	Caution Cat: B
	Remedy: Press the ALERT ACK key. Confirm Own Ship location and adjust as necessary.		
278*2	LOST LOG(WT) SIG	No speed through water data received for thirty seconds when [LOG(WT)] is NOT set as speed reference.	Caution Cat: B
	Remedy: Press the ALERT ACK key. Use a different sensor if necessary.		
284*2	LOST LOG(BT) SIG	No speed over ground data received for thirty seconds when [LOG(BT)] is NOT set as speed reference.	Caution Cat: B
	Remedy: Press the ALERT ACK key. Use a different sensor if necessary.		
380*2	LOST AIS COM	No AIS data received for thirty seconds when AIS function is OFF.	Caution Cat: B
	Remedy: Press the ALERT ACK key. Check power and connection to AIS unit.		
279*2	LOST COG/SOG SIG	No COG/SOG data received from EPFS device for thirty seconds when [EPFS] is NOT set as speed reference.	Caution Cat: B
	Remedy: Press the ALERT ACK key. Restore the signal. This indication cannot be erased if the COG/SOG signal is missing. The indication is automatically removed when the signal is restored.		
784*2	WRONG IP ADDR	LAN1 IP address is in use by other equipment.	Caution Cat: B
	Remedy: Press the ALERT ACK key. Check IP settings and assign a unique IP address.		
495	ANCHOR WATCH	Ship position outside set anchor watch zone.	Warning Cat: B
	Remedy: Press the ALERT ACK key. Confirm Own Ship location and adjust as necessary.		
790	ARRIVED AT WPT*1	Ship has entered the destination arrival alert zone.	Warning Cat: B
	Remedy: Press the ALERT ACK key. No other action required.		
791	XTD LIMIT EXCEEDED*1	Cross-track error, ship is off-course.	Warning Cat: B
	Remedy: Press the ALERT ACK key. Check course and adjust as necessary.		
472*2	POSN SOURCE CHG	Positioning sensor input lost, automatically changed sensors.	Indication
	Remedy: Press the ALERT ACK key. The indication is automatically removed when the signal is restored or a different sensor is selected		
474*2	SPD SOURCE CHG	Speed sensor input lost, automatically changed sensors.	Indication
	Remedy: Press the ALERT ACK key. The indication is automatically removed when the signal is restored or a different sensor is selected		
741*2	ISW: NO SIGNAL	Selected radar has an error. (Only displayed when Interswitch is active.)	Indication
	Remedy: Press the ALERT ACK key. Use radar as standalone or restore the external radar to normal operating condition.		

APPX. 3 ALERT CODES, MESSAGES AND MEANINGS

Alert code	Alert title	Explanation	Priority & Category
742* ²	ISW: NO RADAR	Communication with selected radar interrupted or lost. (Only displayed when Interswitch is active.)	Indication
	Remedy: Press the ALERT ACK key. Use radar as standalone or check connection and power to the external radar.		
743* ²	ISW: STBY	Selected radar entered standby mode.	Indication
	Remedy: Press the ALERT ACK key. Check transmission status of the selected radar.		
744* ²	ISW: NO SENSOR	No heading data was received from the selected radar for more than five seconds.	Indication
	Remedy: Press the ALERT ACK key. Check heading data input status for the selected radar.		

*¹: This alert is output only when [TYPE] is set to [Non-IMO].

*²: This alert/indication appears on-screen, however, no alert sentence is released.

APPX. 4 DATA COLOR AND MEANING

Validity and integrity of input data (mode indicator)

Data color	HDG	L/L * ¹	SPD	COG/SOG
Normal color (normal data)	THS-A, E HDT	GNS-A, D * ² , F, P, R and (NAV status: S, V) GGA-1, 2 * ² , 3, 4, 5 GLL-A, D and (status: A) RMC-A, D, F, P, R and (status: A) and (NAV status: S, V)	VBW-A VHW	VTG-A, D, P RMC-A, D, F, P, R and (status: A) and (NAV status: S, V).
Red color (invalid data)		GNS-E, M, S GGA-6, 7, 8 GLL-E, M, S and (status: A) RMC-E, M, S and (Status: A)		VTG-E, M, S RMC-E, M, S, and (sta- tus: A)
Yellow color (low integrity)		GNS-A, D* ² , F, P, R, and (NAV status: C, U) RMC-A, D, F, P, R and (status: A) and (NAV status: C, U)		RMC-A, D, F, P, R and (status: A) and (NAV status: C, U)
***.*	THS-M, N, S	GNS-N, (NAV status: N) GGA-0 RMC-N, (status: V), (NAV status: N) GLL-N, (status: V)	VBW-V	VTG-N RMC-N (sta- tus: V)

*¹: Low or doubtful integrity can occur when the GBS sentence gives a RAIM error rate of 10 m or higher. In this case, the ship's latitude and longitude indications are displayed in yellow.

*²: "Age of differential GPS data" in GGA and GNS sentences is ten seconds or higher. In this case, ship's latitude and longitude are displayed in yellow.

APPX. 5 ABBREVIATIONS

A:

Abbreviation	Word	Abbreviation	Word
ACK	Acknowledge	ACQ	Acquire
Act	Activate	ACE	Automatic Clutter Elimination
ANT	Antenna	AIS	Automatic Identification System
AP	Autopilot	ATON	Aids to Navigation
AUTO	Automatic	A/C RAIN	Anti Clutter Rain
A/C SEA	Anti Clutter Sea	AID	Aid
ALF	ALF sentence	ALR	Alarm
AMB	Amber	AMS	Alert Management System
ANCH	Anchor Watch	APR	April
ARC	Arc	AUG	August

B:

Abbreviation	Word	Abbreviation	Word
BAM	Bridge Alert Management System	BLU	Blue
BCR	Bow Crossing Range	BCT	Bow Crossing Time
BRG	Bearing	BRILL	Brilliance
BT	Bottom Tracking		

C:

Abbreviation	Word	Abbreviation	Word
CALC	Calculated	CALIB	Calibrate
CCRP	Consistent Common Reference Point	CCRS	Consistent Common Reference System
CDROM	Compact Disc Read Only Memory	Ch	Channel
CHG	Change	COG	Course Over Ground
COM	Communication	CONT	Continue
CORR	Corrected/Correction	CPA	Closest Point of Approach
CPU	Central Processing Unit	CTW	Course Through the Water
CRS	Course	CU	Course Up
CURS	Cursor	CYA	Cyan

D:

Abbreviation	Word	Abbreviation	Word
DATREP	Data Reporting	DISP	Display
DEC	December	DIST	Distance
deg	degree(s)	DR	Dead Reckoning
DEST	Destination	DTE	Data Terminal Equipment
DGPS	Differential GPS	DTM	Datum
Diff	Differential		

E:

Abbreviation	Word	Abbreviation	Word
E	East	EAV	Echo Averaging
EBL	Electronic Bearing Line	ECDIS	Electronic Chart Display and Information System
ENC	Electronic Navigational Chart	EP	Estimated Position
EPFS	Electronic Position Fixing System	EQUIP	Equipment
ERR	Error	ES	Echo Stretch
ETD	Estimated Time of Departure	EXT	External

F:

Abbreviation	Word	Abbreviation	Word
FEB	February	FILT	Filter/Filtered
FUNC	Function		

G:

Abbreviation	Word	Abbreviation	Word
GAP	Gap	GC	Great Circle
GND	Ground	GMDSS	Global Maritime Distress and Safety System
GPS	Global Positioning System	GRAD	Gradation
GRN	Green	GRY	Gray
GT	Gross Tonnage		

H:

Abbreviation	Word	Abbreviation	Word
HD	Heading	HDG	Heading
HL	Heading Line	HSC	High Speed Craft

I:

Abbreviation	Word	Abbreviation	Word
IBS	Integrated Bridge System	ID	Identification
IMO	International Maritime Organization	INFO	Information
INS	Integrated Navigation System	IP ADDRESS	Internet Protocol Address
IR	Interference Rejection		

J:

Abbreviation	Word	Abbreviation	Word
JAN	January	JUN	June
JUL	July		

APPX. 5 ABBREVIATIONS

L:

Abbreviation	Word	Abbreviation	Word
L	Long pulse	LAT	Latitude
LAN	Local Area Network	LCD	Liquid Crystal Display
LIM	Limit	L/L	Latitude/Longitude
LOG	Log	LON	Longitude
LOP	Line Of Position		

M:

Abbreviation	Word	Abbreviation	Word
MAG	Magnetic	MAG	Magenta
MAN	Manual	MAR	March
MAX	Maximum	MAY	May
MBS	Main Bang Suppression	M-CYA	Multi Cyan
MFDF	Medium Frequency Direction Finder	MENU	Menu
M-GRN	Multi Green	MIC	Monolithic Integrated Circuit
MID	Middle	M1	Medium pulse 1
M2	Medium pulse 2	M3	Medium pulse 3
MOB	Man Over Board	MON	Monday
Msgs	Messages	MSC	Maritime Safety Committee

N:

Abbreviation	Word	Abbreviation	Word
N	North	NAV	Navigation
NLT	Not Less Than	NMT	Not More Than
NOV	November	NR	Noise Rejector

O:

Abbreviation	Word	Abbreviation	Word
OS	Own Ship	OCT	October

P:

Abbreviation	Word	Abbreviation	Word
PAST POSN	Past Positions	PC	Personal Computer
PI	Parallel Index Line	PM	Performance Monitor
PNK	Pink	POSN	Position
PPI	Plan Position Indicator		

Q:

Abbreviation	Word
QLTY	Quality

R:

Abbreviation	Word	Abbreviation	Word
RACON	Radar beacon	RAD	Radius
RAM	Random Access Memory	RAIM	Receiver Autonomous Integrity Monitoring
RD	Read	RAIN	Anti Clutter Rain
REF	Reference/Echo Reference	RED	Red
REJ	Rejection	R, REL	Relative
RFC board	RF Control board	RENC	Regional ENC Co-ordinating Centre
RM	Relative Motion	RL	Rhumb Line
ROM	Read Only Memory	RNG	Range
RTE	Route	ROT	Rate Of Turn
RX	Receive	RTGT	Reference Target

S:

Abbreviation	Word	Abbreviation	Word
S	South	S1	Short pulse1
S2	Short pulse2	S57	IHO Special Publication 57
SAR	Search and Rescue	SART	Search and Rescue Transponder
SD	Secure Digital	SEA	Anti Clutter Sea
SEL	Select	SENC	System ENC
SEP	September	SIO	Serial Input Output
SOG	Speed Over Ground	SOLAS	Safety of Life at Sea
SPD	Speed	SPU	Signal Processing Unit board
STAB	Stabilized	STBD	Starboard
STBY	Standby	STC	Sensitivity time control
Std	Standard	STW	Speed Through Water
SW	Switch	SYM	Symbol
Symb	Symbol(s)	SYN TGT	Synthetic Target

T:

Abbreviation	Word	Abbreviation	Word
T	True	TAG	Tag
TCPA	Time to CPA	TGT	Target
TM	True Motion	TPL	Transferred Line Of Position
True-G	True ground stabilized	True-S	True sea stabilized
TT	Target Tracking/Tracked Target	TTG	Time To Go
TUNE	Tune/Tuning control	TX	Transmit

U:

Abbreviation	Word	Abbreviation	Word
UNCAL	Uncalibrated	UTC	Coordinated Universal Time

V:

Abbreviation	Word	Abbreviation	Word
VECT	Vector	VRM	Variable Range Marker

APPX. 5 ABBREVIATIONS

W:

Abbreviation	Word	Abbreviation	Word
W	West	WAT	Water
WGS	World Geodetic System	WHT	White
W/O	Without	WOP	Wheel Over Point
WP	Waypoint	WPT	Waypoint
WR	Write	WT	Water Tracking
WTC	Water Tracking Current		

X:

Abbreviation	Word	Abbreviation	Word
XTD	Cross Track Distance	XTE	Cross Track Error

Y:

Abbreviation	Word
YEL	Yellow









Units of measurement

Abbreviation	Word	Abbreviation	Word
deg	Degree(s)	ft	Foot/feet
H	Hour(s)	km	Kilometer(s)
KM	Kilometer(s)	kn	Knot(s)
KYD	Kiloyard(s)	min	Minute(s)
m	Meter(s)	MHz	Megahertz
NM	Nautical miles	sec	Second(s)
SM	Statute mile(s)	°	Degree(s)

APPX. 6 SYMBOLS

The pages following list the symbols which can be displayed on your radar. For non-IMO type radars, some symbol colors can be changed (see "How to select the mark color (non-IMO type only)" on page 1-55).





















General radar symbols

Symbol	Name
 (on power switch)	Power Symbol
	Own Ship Marker
	Origin Marks
	Fixed Range Rings
	Variable Range Markers (from left, VRM1, VRM2)
	Electronic Bearing Lines (from left EBL1, EBL2)
	OS Mark
+	Cursor
	Heading Line
-----	North Marker
-----	Stern Marker
	Barge Icon
	Drop Mark



Radar map symbols (All radar types)

<u>Symbol</u>	<u>Name</u>
△	Mark
⚡	Danger Highlight
⚓	Buoy
⚓	Buoy
⚓	Buoy
○	Buoy
•	Buoy
✕	Danger Highlight
⊖	Mark
□	Mark
⚓	Mark
■	Mark
◇	Mark
—	Mark
••••	Mark
••••	Nav Line (map)
▭	Coastline
••••	Contour
≡	Prohibited Area
⋈ (cable)	Danger Highlight
⊖ (w/line)	Buoy
△ (w/line)	Mark
□ (w/line)	Mark
◇ (w/line)	Mark





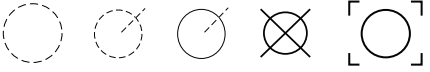







Radar map symbols (IMO type)







<u>Symbol</u>	<u>Name</u>	<u>Symbol</u>	<u>Name</u>
 Red	Buoy	 Orange	Mark
 Green	Buoy	 Orange	Mark
 Red	Buoy	 Orange	Mark
 Green	Buoy	 Purple	Navline (map)
 Red	Buoy	 White	Coastline
 Green	Buoy	 Gray	Contour Line
 Red	Buoy	 Purple	Danger Highlight
 Green	Buoy	 Purple (cable)	Danger Highlight
 Purple	Danger Highlight	 Orange	Mark
 Purple	Danger Highlight	 Orange	Mark

TT symbols

TT symbols	
<u>Symbol</u>	<u>Name</u>
	Acquired targets (from left: initial acquisition, one minute after acquisition, steady tracking, lost target, target selected for data readout)
	Acquisition zone
S	Performance test

























AIS Symbols**Object symbols**













Symbol	Name	Description
	AIS target past position point	Mark past position.
	Sleeping AIS target	Sleeping AIS symbol. (Lines are thinner than Active AIS symbol.)
	Activated AIS target	Activated AIS target, with vector for course and speed. (Lines are thicker than sleeping AIS symbol.) Color can be changed with the menu.
	Activated AIS target, true scale symbol	Activated AIS target with symbol shown in true scale. Association AIS symbol or activate AIS symbol is displayed within the ship's symbol when activated. This symbol disappears when the size of the true scale symbol is smaller than 3 mm on the display.
	AIS SART	AIS SART (search and rescue radar transponder), includes AIS MOB, EPIRB-AIS
	AIS SART Test	AIS SART (search and rescue radar transponder) test.
	Selected AIS target	AIS and TT target declared as "association target". AIS symbol and AIS data are used.
	Heading - turn indicator	Target's direction of turning.
	SAR aircraft - fixed wing	SAR aircraft - fixed wing
	SAR aircraft - helicopter	SAR aircraft - helicopter
	AIS Base Station	AIS base station
	Synthetic Target	VTS generated synthetic target.
	Synthetic Target - Distress	Synthetic target in vessel distress situations.

Symbol	Name	Description
	AIS target selected	Target selected to display its data.
	SAR vessel	SAR (Search And Rescue) vessel.
	Sleeping AIS target with no CPA/TCPA data	Sleeping AIS target symbol without HDG and COG. Dashed line.
	Activated AIS target with no CPA/TCPA data	Activated AIS target symbol without HDG and COG. Dashed line.
<p data-bbox="319 663 424 689">AIS target</p>  <p data-bbox="309 741 437 790">AIS physical AtoN</p>  <p data-bbox="287 853 459 880">AIS base station</p> 	Unread AIS message (Note 5)	AIS symbol with unread or viewing AIS message.

AtoN symbols

Note: Synthetic AtoN is described as basic shape.

AIS Physical AtoN Symbol*1	AIS Virtual AtoN Symbol	Meaning
		Basic shape
		RACON
		Emergency wreck mark
		North cardinal mark
		East cardinal mark
		South cardinal mark
		West cardinal mark
		Port hand mark
		Starboard hand mark
		Isolated danger
		Safe water
		Special mark

AIS Physical AtoN Symbol ^{*1}	AIS Virtual AtoN Symbol	Meaning
Off Posn 	— ^{*2}	Off position
Unlit 	—	Off or dimmed lighting installations
Racon err 	—	RACON error
Error 	—	Abnormal lighting installation, or AIS AtoN with abnormal lighting installation and racon installation
Missing 	— ^{*2}	Missing
		
		Self-propelled, but direction not reported or unavailable mobile AtoN
		Tethered mobile AtoN
		Mobile AtoN with COG information. Arrow mark points in course direction of COG within $\pm 22.5^\circ$ sectors.

^{*1}: The purpose indicator appears at the top of a physical AtoN symbol. The indicator is always displayed in the radar mode, and when a symbol of this type is selected in the chart mode or chart radar mode. See the example below.

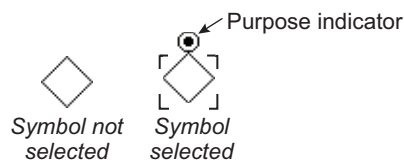

^{*2}: “Unlit”, “Racon err” and “Error” may be included.

APPX. 7 PARTS LOCATION

This section shows the location of PC boards inside the equipment which can be replaced. For information on parts, or to replace a part, consult your local FURUNO dealer.

Processor unit RPU-024 (AC and DC type)

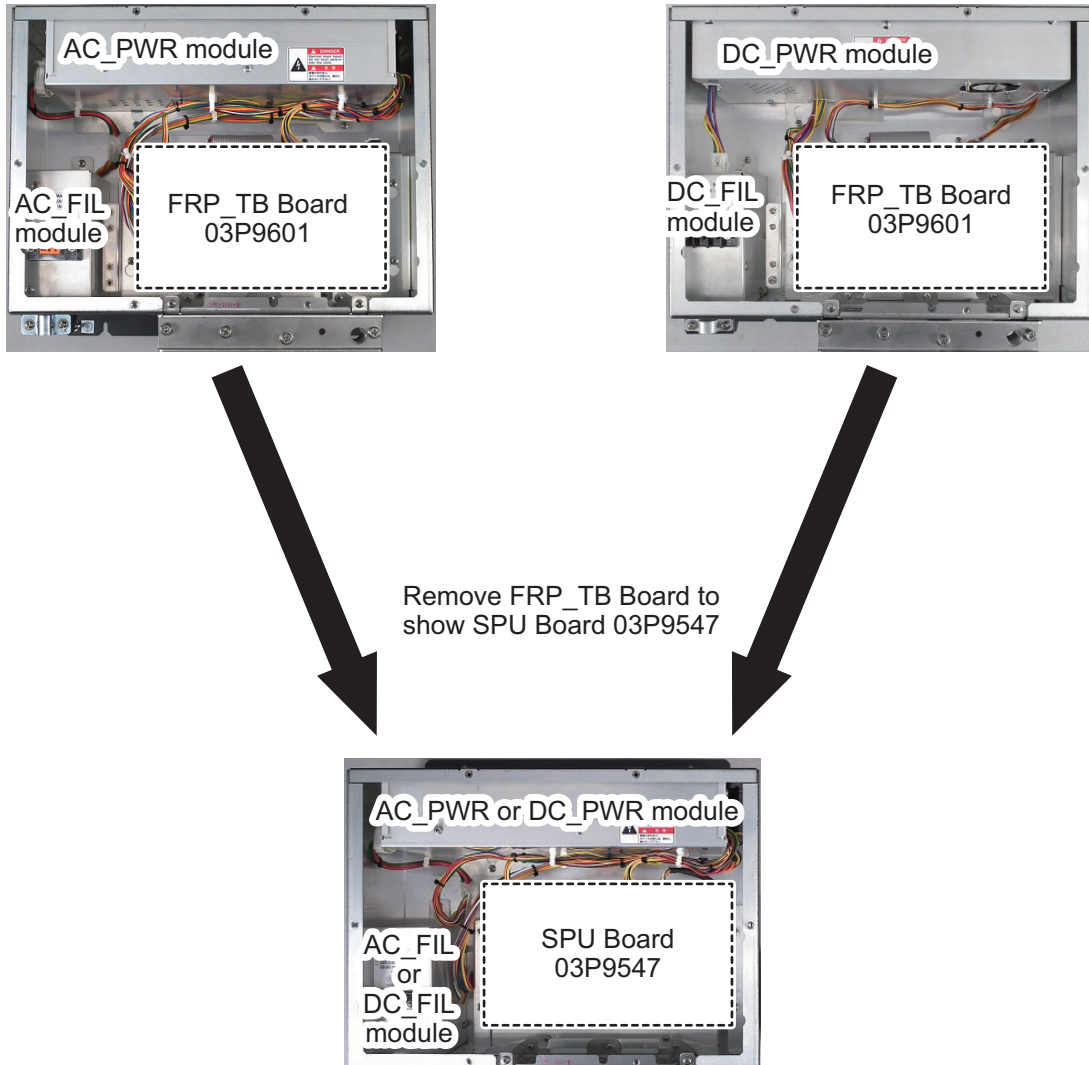

Marine display MU-150HD

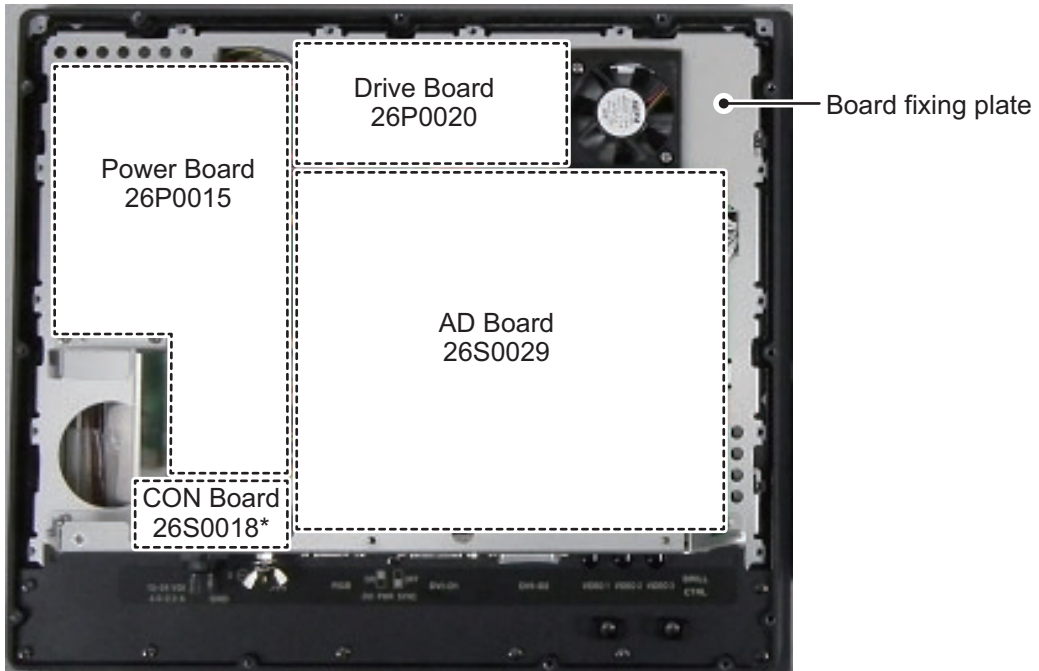

*: CON Board 26S0018 is located under the overhang on the board fixing plate.

Remove Power Board 26P0015, Drive Board 26P0020, AD Board 26S0029, CON Board 26S0018 and the Board fixing plate to show the LCD module and PANEL Board 26P0013.

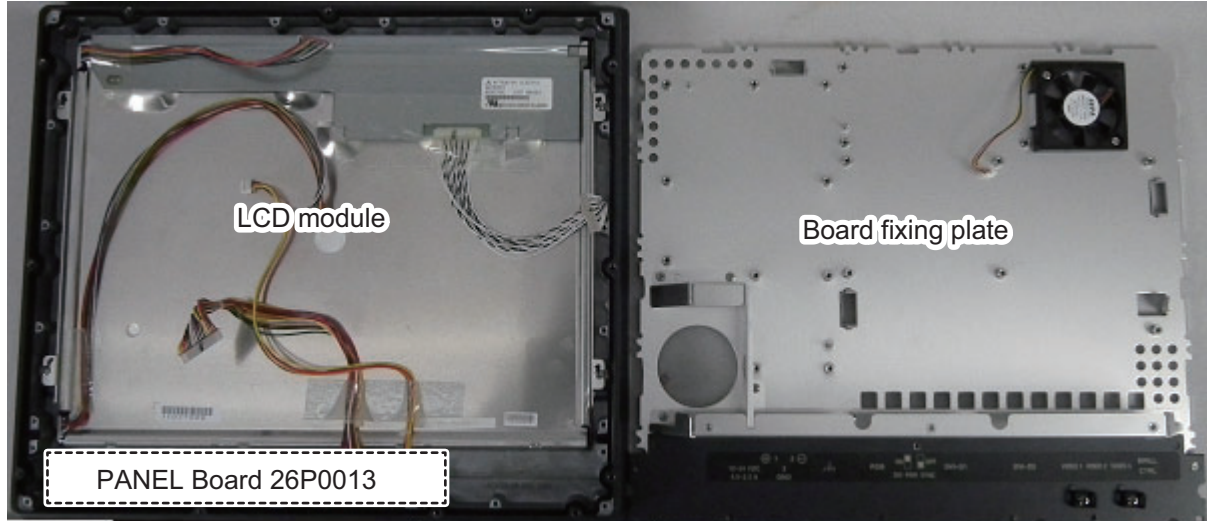

Control Unit RCU-028

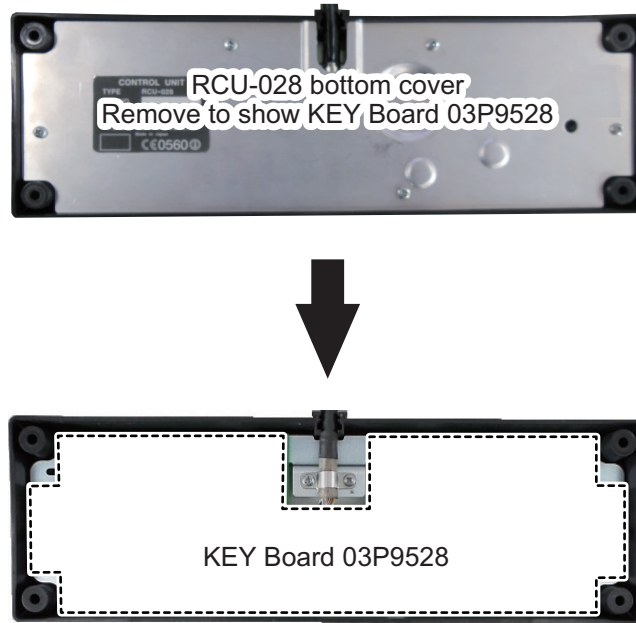

Transceiver Unit RTR-100/101 Rear view

Note: The board location for both the RTR-101 and RTR-100 are the same. The image below shows the RTR-101.

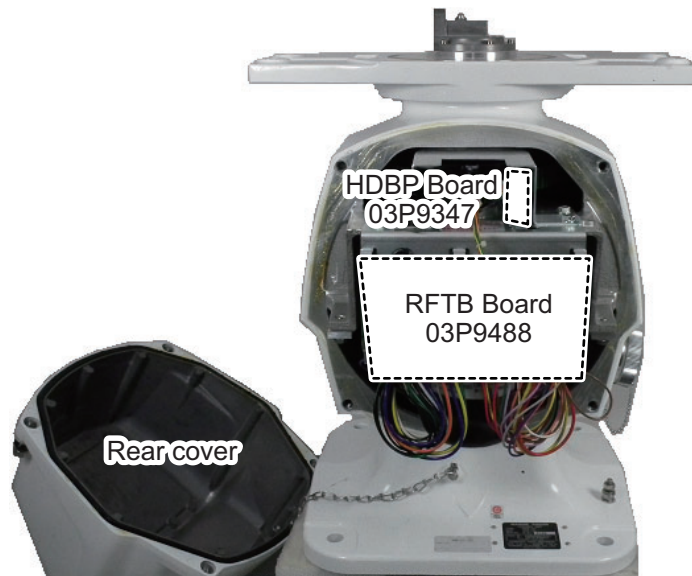

Transceiver Unit RTR-100/101 Front view

Note: The board location for both the RTR-101 and RTR-100 are the same. The image below shows the RTR-101.



Rear view with cover and transceiver module RTR-101 removed.

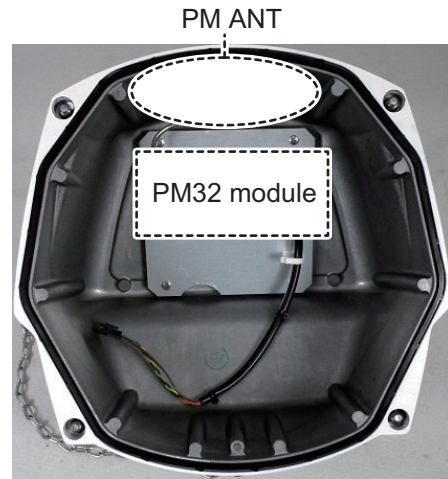

Rear cover inner with PM32 module showing.

Transceiver module RTR-100/101 right-side view

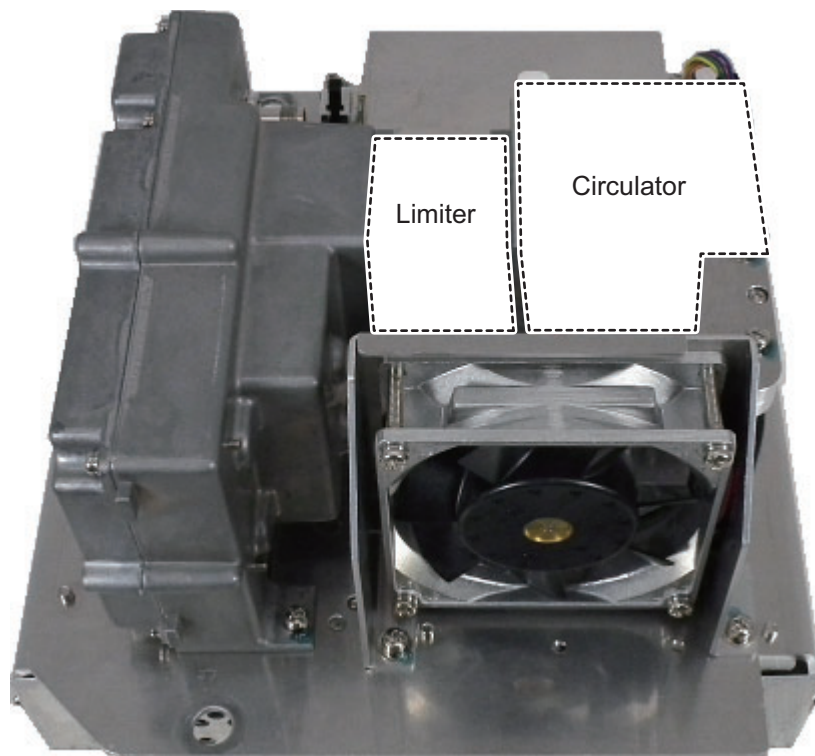

Transceiver module RTR-100/100 rear view

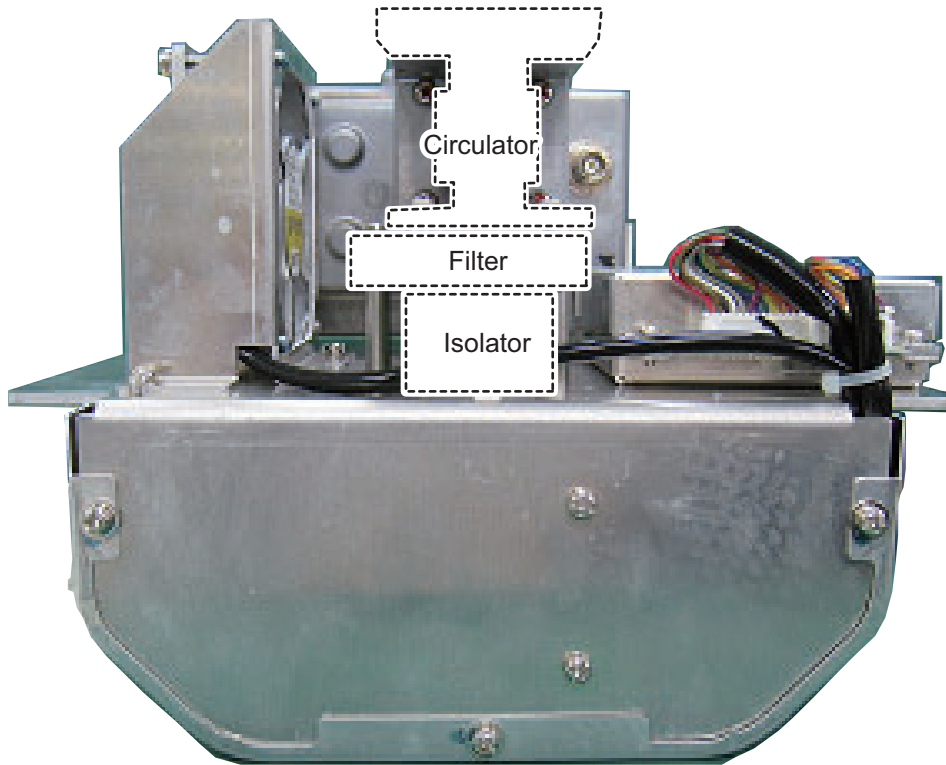

Transceiver module RTR-100/101 front view

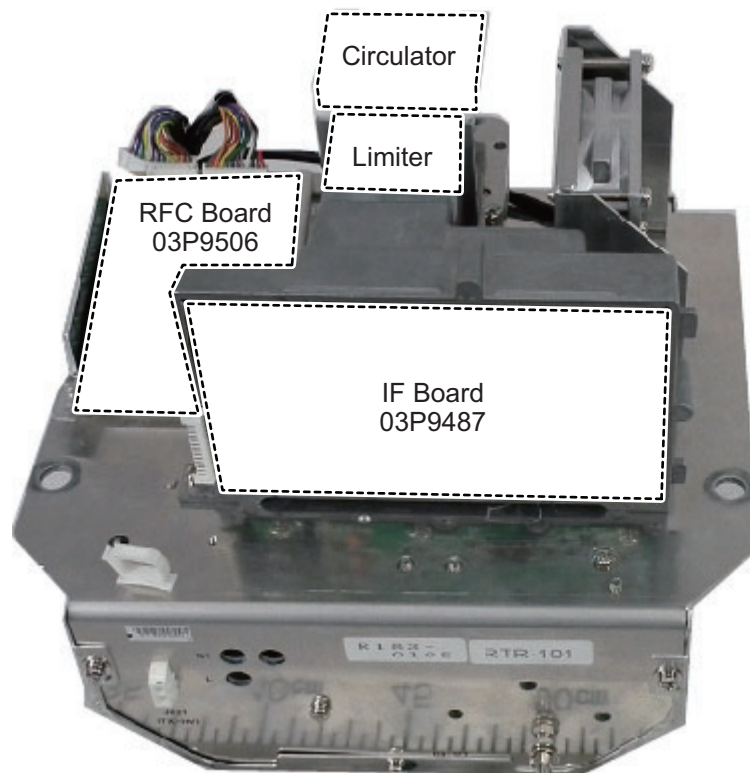

Remove IF Board 03P9487 to show MIC board 03P9505 (covered by board fixing panel).

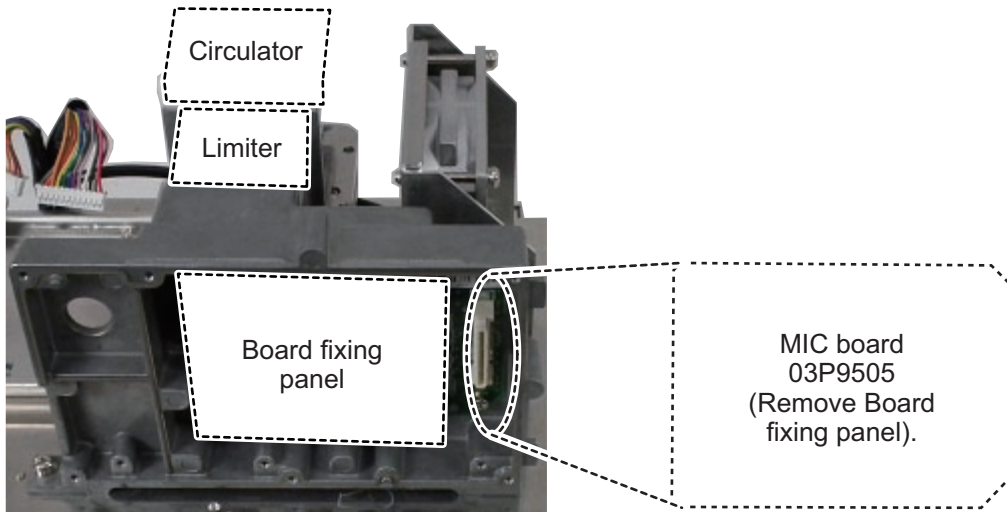

Transceiver module RTR-101 underside-front view (For FAR-1518/1528/BB)

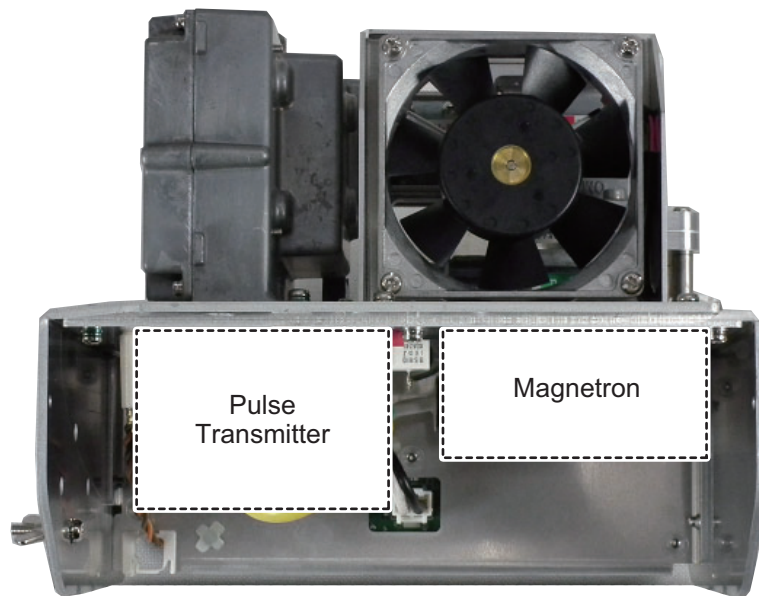

Transceiver module RTR-101 underside-rear view (For FAR-1518/1528/BB)

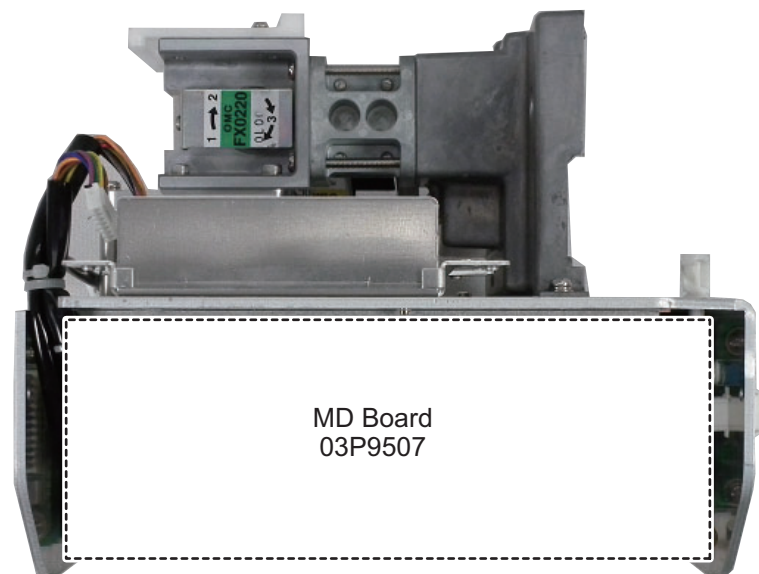

Transceiver module RTR-100 underside-front view

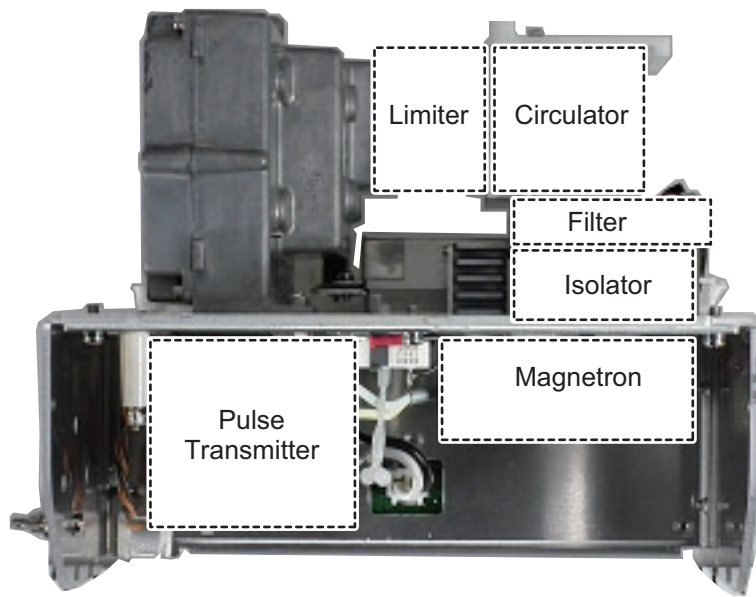

Transceiver module RTR-100 underside-rear view

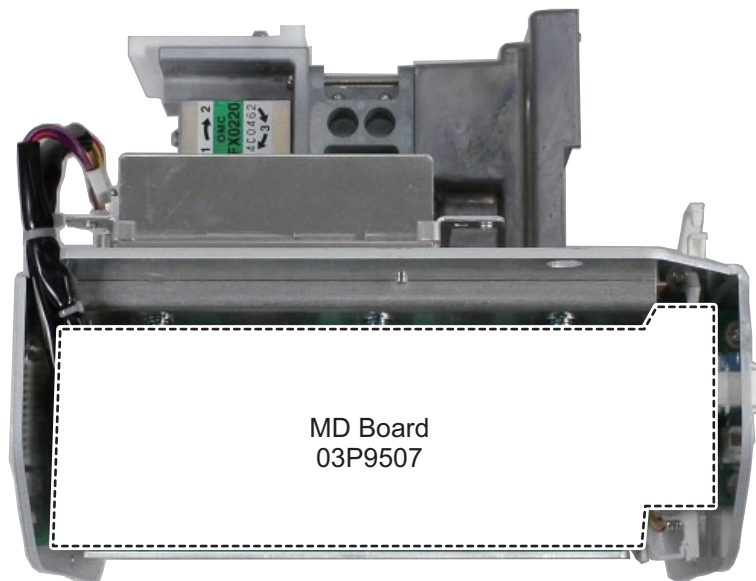

APPX. 8 RADIO REGULATORY INFORMATION

USA-Federal Communications Commission (FCC)

This device complies with part 15 of the FCC Rules. Operation is subject to the following two conditions:

- (1) This device may not cause harmful interference, and
- (2) This device must accept any interference received, including interference that may cause undesired operation. Any changes or modifications not expressly approved by the party responsible for compliance could void the user's authority to operate the equipment.

Caution: Exposure to Radio Frequency Radiation

- This equipment complies with FCC radiation exposure limits set forth for an uncontrolled environment and meets the FCC radio frequency (RF) Exposure Guidelines in Supplement C to OET65.
- This equipment should be installed and operated keeping the radiator at least XX cm or more away from person's body.
- This device must not be co-located or operating in conjunction with any other antenna or transmitter.

Canada-Industry Canada (IC)

Caution: Exposure to Radio Frequency Radiation

This equipment complies with IC radiation exposure limits set forth for an uncontrolled environment and meets RSS-102 of the IC radio frequency (RF) Exposure rules. This equipment should be installed and operated keeping the radiator at least XX cm or more away from person's body.

Cet équipement est conforme aux limites d'exposition aux rayonnements énoncées pour un environnement non contrôlé et respecte les règles d'exposition aux fréquences radioélectriques (RF) CNR-102 de l'IC. Cet équipement doit être installé et utilisé en gardant une distance de XX cm ou plus entre le dispositif rayonnant et le corps.

To reduce potential radio interference to other users, the antenna type and its gain should be so chosen that the equivalent isotropically radiated power (EIRP) is not more than that required for successful communication.

XX cm

FAR-1513 (RTR-086A)	210 cm
FAR-1523 (RTR-087A)	460 cm
FAR-1518 (RTR-100)	410 cm
FAR-1528 (RTR-101)	610 cm

**SPECIFICATIONS OF MARINE RADAR
FAR-1513/1523 (-BB)**

1 ANTENNA UNIT

- 1.1 Antenna type Slotted waveguide array
- 1.2 Radiator length 4 ft (XN12A), 6 ft (XN13A)
- 1.3 Horizontal beamwidth 1.9° (XN12A), 1.35° (XN13A)
- 1.4 Vertical beamwidth 20°
- 1.5 Sidelobe attenuation
 XN12A -24 dB (within ±20° of main-lobe)
 XN13A -28 dB (within ±20° of main-lobe)
- 1.6 Polarization Horizontal
- 1.7 Rotation 24 rpm (RSB-0070), 48 rpm (RSB-0073)
- 1.8 Wind load 100 kn relative

2 RF TRANSCEIVER

- 2.1 Frequency 9410 MHz ±30 MHz, P0N
- 2.2 Output power
 FAR-1513 (-BB) 12 kW
 FAR-1523 (-BB) 25 kW
- 2.3 Minimum range 25 m
- 2.4 Range discrimination 25 m
- 2.5 Range accuracy 1 % of range in use or 10 m whichever is the greater
- 2.6 Bearing accuracy ±1°
- 2.7 Range, Pulselength and Pulse Repetition Rate

PRR (Hz approx.)	Range scale (NM)																
	0.125	0.25	0.5	0.75	1	1.5	2	3	4	6	8	12	16	24	32	48	96
2100	S																
1200						M											
600*								L									

*: 500 Hz on 96 NM ranges

- 2.8 IF frequency 60 MHz

3 PROCESSOR UNIT

3.1 Range scales and ring interval

Scale (NM)	0.125	0.25	0.5	0.75	1	1.5	2	3	4	6	8	12	16	24	32	48	96
RI (NM)	0.025	0.05	0.1	0.25	0.25	0.25	0.5	0.5	1	1	2	2	4	4	8	8	16
Number of rings	5	5	5	3	4	6	4	6	4	6	4	6	4	6	4	6	6

- 3.2 Echo tones 32 levels
- 3.3 Warm-up time 90 s approx. (FAR-1513), 3 minutes approx. (FAR-1523)
- 3.4 Presentation mode Head-up, STAB Head-up, North-up (TM/RM), Course-up, Stern-up
- 3.5 Marks Cursor, Radar ring, Heading mark, North mark, Bearing line, Vector, Map mark, Zoom, VRM, EBL, Acquisition zone
- 3.6 Target tracking (TT) Auto or manual acquisition: 50 targets in 0.2-32 NM
 Tracking: 5/10 pts on all target
 Time of vector: 30 s to 60 minutes
- 3.7 AIS Display capacity: 300 targets, Tracking: 5/10 pts on all target

		Time of vector: 30 s to 60 minutes
3.8	Echo trail	True/Relative, Trail length: 0 to 30 minutes (30 s steps) or continue
3.9	Radar map	5,000 pts
3.10	Interswitch function	Selected from menu

4 MARINE DISPLAY/MONITOR UNIT (MU-150HD/MU-150HD-CV15/MU-152*)

4.1	Screen type	15-inch color LCD, 304 x 228 mm, 1024 x 768 (XGA)
4.2	Brightness	
	MU-150HD	1,000 cd/m ² typical
	MU-152	400 cd/m ² typical
4.3	Contrast	
	MU-150HD	600:1
	MU-152	900:1
4.4	View angle	160° typical
4.5	Radar effective diameter	205 mm

*: The display unit for BB-type should be prepared by user.

5 INTERFACE

5.1	Number of ports on processor unit	
	Heading	1 port: AD-10 format or IEC61162-2
	Serial	IEC61162-2: 2 ports (AIS/HDG) IEC61162-1: 4 ports (GPS/LOG/AMS/ECDIS)
	Contact closure	Alert output: 4 ch, Remote ACK input, System fail, power fail
	Remote display	2 ports (Signal: HD, BP, Trigger and Video)
	LAN	Ethernet 100Base-TX: 1 port
	DVI	DVI-D: 1 port for main display
	RGB	1 port for VDR or RGB monitor
5.2	Data sentences	
	Input	ABK, ACK, ACN, ALR, BWC, BWR, CUR, DBK, DBS, DBT, DPT, DTM, GBS, GGA, GLL, GNS, HBT, HDG, HDM, HDT, MTW, MWV, RMB, RMC, RTE, THS, VBW, VDM, VDO, VDR, VHW, VSD, VTG, VWR, VWT, WPL, ZDA
	Output	ABM, ALC, ALF, ALR, ARC, BBM, EVE, HBT, OSD, RSD, TLB, TLL, TTD, TTM, VSD

6 POWER SUPPLY

6.1	Processor unit	
	FAR-1513 (-BB)	24 VDC (21.6-31.2 V): 5.0 A max. (24 rpm), 5.6 A max. (48 rpm)
	FAR-1523 (-BB)	24 VDC (21.6-31.2 V): 6.4 A max. (24 rpm), 7.0 A max. (48 rpm)
6.2	Marine display/Monitor unit	
	MU-150HD	12-24 VDC (10.8-31.2 V): 4.5-2.2 A
	MU-152	12-24 VDC (10.8-31.2 V): 1.9-0.9 A
6.3	AC/DC power supply unit (option)	
	PR-241	100-230 VAC, 1 phase, 50-60 Hz
	PR-850A	100/110/120/200/220/240 VAC, 1 phase, 50/60 Hz
	PR-851	100-240 VAC, 1 phase, 50-60 Hz

7 ENVIRONMENTAL CONDITIONS

7.1 Ambient temperature

Antenna unit -25°C to +55°C (storage: +70°C or less)

Processor unit -15°C to +55°C

Marine display (Monitor) -15°C to +55°C

7.2 Relative humidity 93% or less at +40°C

7.3 Degree of protection

Antenna unit IP26

Processor unit IP20 (IP22: option)

Control unit IP22

Marine display (Monitor) IP56 (panel), IP22 (chassis)

7.4 Vibration IEC 60945 Ed.4

8 UNIT COLOR

8.1 Antenna unit N9.5 (fixed)

8.2 Processor/control unit N2.5 (fixed)

8.3 Marine display (Monitor) N2.5 (fixed)

**SPECIFICATIONS OF MARINE RADAR
FAR-1518/1528 (-BB)**

1 ANTENNA UNIT

- 1.1 Antenna type Slotted waveguide array
- 1.2 Radiator length 4 ft (XN12AF), 6.5 ft (XN20AF), 8 ft (XN24AF)
- 1.3 Horizontal beamwidth 1.9° (XN12AF), 1.23° (XN20AF), 0.95° (XN24AF)
- 1.4 Vertical beamwidth 20°
- 1.5 Sidelobe attenuation
 XN12AF -24 dB (within ±20° of main-lobe)
 XN20/24AF -28 dB (within ±20° of main-lobe)
- 1.6 Polarization Horizontal
- 1.7 Rotation 26 rpm (RSB-120), 48 rpm (RSB-121)
- 1.8 Wind load 100 kn relative

2 RF TRANSCEIVER

- 2.1 Frequency 9410 MHz ±30 MHz, P0N
- 2.2 Output power
 FAR-1518 (-BB) 12 kW
 FAR-1528 (-BB) 25 kW
- 2.3 Minimum range 25 m
- 2.4 Range discrimination 25 m
- 2.5 Range accuracy 1 % of range in use or 10 m whichever is the greater
- 2.6 Bearing accuracy ±1°
- 2.7 Range, Pulselength and Pulse Repetition Rate

PRR (Hz approx.)	Range scale (NM)											
	0.125	0.25	0.5	0.75	1.5	3	6	12	24	48	96	
3000*	S1											
2760*	S2											
1500				M1								
1000				M2								
1000						M3						
600**							L					

*: 2200 Hz approx. with TT range on 32 NM. **: 500 Hz on 96 NM range.

- 2.8 IF frequency 60 MHz

3 PROCESSOR UNIT

- 3.1 Range scales and ring interval

Scale (NM)	0.125	0.25	0.5	0.75	1.5	3	6	12	24	48	96
RI (NM)	0.025	0.05	0.1	0.25	0.25	0.5	1	2	4	8	16
Number of rings	5	5	5	3	6	6	6	6	6	6	6

- 3.2 Echo tones 32 levels
- 3.3 Warm-up time 3 minutes approx.
- 3.4 Presentation mode Head-up, STAB Head-up, North-up (TM/RM), Course-up, Stern-up
- 3.5 Marks Cursor, Radar ring, Heading mark, North mark, Bearing line,
 Vector, Map mark, Zoom, VRM, EBL, Acquisition zone
- 3.6 Target tracking (TT) Auto or manual acquisition: 50 targets in 0.2-32 NM
 Tracking: 5/10 pts on all target

		Time of vector: 30 s to 60 minutes
3.7	AIS	Display capacity: 300 targets, Tracking: 5/10 pts on all target Time of vector: 30 s to 60 minutes
3.8	Echo trail	True/Relative, Trail length: 0 to 30 minutes (30 s steps) or continue
3.9	Radar map	5,000 pts
3.10	Interswitch function	Selected from menu

4 MARINE DISPLAY/MONITOR UNIT (MU-150HD/MU-152*)

4.1	Screen type	15-inch color LCD, 304 x 228 mm, 1024 x 768 (XGA)
4.2	Brightness	
	MU-150HD	1,000 cd/m ² typical
	MU-152	400 cd/m ² typical
4.3	Contrast	
	MU-150HD	600:1
	MU-152	900:1
4.4	View angle	160° typical
4.5	Radar effective diameter	205 mm

*: The display unit for BB-type should be prepared by user.

5 INTERFACE

5.1	Number of ports on processor unit	
	Heading	1 port: AD-10 format or IEC61162-2
	Serial	IEC61162-2: 2 ports (AIS/HDG) IEC61162-1: 4 ports (GPS/LOG/AMS/ECDIS)
	Contact closure	Alert output: 4 ch, Remote ACK input, System fail, power fail
	Remote display	2 ports (Signal: HD, BP, Trigger and Video)
	LAN	Ethernet 100Base-TX: 1 port
	DVI	DVI-D: 1 port for main display
	RGB	1 port for VDR or RGB monitor
5.2	Data sentences	
	Input	ABK, ACK, ACN, ALR, BWC, BWR, CUR, DBK, DBS, DBT, DPT, DTM, GBS, GGA, GLL, GNS, HBT, HDG, HDM, HDT, MTW, MWV, RMB, RMC, RTE, THS, VBW, VDM, VDO, VDR, VHW, VSD, VTG, VWR, VWT, WPL, ZDA
	Output	ABM, ALC, ALF, ALR, ARC, BBM, EVE, HBT, OSD, RSD, TLB, TLL, TTD, TTM, VSD

6 POWER SUPPLY

6.1	Processor unit	
	AC type	
	FAR-1518 (-BB)	100-115/220-230 VAC: 3.0/1.4 A (26 rpm), 3.6/1.6 A (48 rpm)
	FAR-1528 (-BB)	100-115/220-230 VAC: 3.8/1.7 A (26 rpm), 4.3/2.0 A (48 rpm)
	DC type	
	FAR-1518 (-BB)	24 VDC: 6.7 A max. (26 rpm), 8.3 A max. (48 rpm)
	FAR-1528 (-BB)	24 VDC: 8.3 A max. (26 rpm), 10.0 A max. (48 rpm)
6.2	Marine display/Monitor unit	
	MU-150HD	12-24 VDC: 4.5-2.2 A

MU-152	12-24 VDC: 1.9-0.9 A
6.3 Power supply unit (option)	
PR-241	100-230 VAC, 1 phase, 50-60 Hz
PR-850A	100/110/120/200/220/240 VAC, 1 phase, 50/60 Hz
PR-851	100-240 VAC, 1 phase, 50-60 Hz

7 ENVIRONMENTAL CONDITIONS

7.1 Ambient temperature	
Antenna unit	-25°C to +55°C (storage: +70°C or less)
Processor unit	-15°C to +55°C
Marine display (Monitor)	-15°C to +55°C
7.2 Relative humidity	93% or less at +40°C
7.3 Degree of protection	
Antenna unit	IP56
Processor unit	IP20 (IP22: option)
Control unit	IP22
Marine display (Monitor)	IP56 (panel), IP22 (chassis)
7.4 Vibration	IEC 60945 Ed.4

8 UNIT COLOR

8.1 Antenna unit	N9.5 (fixed)
8.2 Processor/control unit	N2.5 (fixed)
8.3 Marine display (Monitor)	N2.5 (fixed)

9 PERFORMANCE MONITOR (PM-32A)

9.1 Frequency range	9380 to 9440 MHz
9.2 Input power	+18dBm to +30dBm
9.3 Output power	-21 dBm (1 st pulse max. output), -41 dBm (1 st pulse min. output)
9.4 Step level	8 to 12 dB (1 st pulse to last pulse)

INDEX

Numerics

2nd trace echoes 1-30

A

Acquisition zone

AZ stabilization 3-19

change AZ reference 3-19

AIS

activating targets, automatically 4-9

activating targets, manually 4-8

auto activate filter 4-9

controls 4-3

CPA/TCPA alarm 4-18

lost object filter 4-16

messages, transmitting 4-22

messages, auto display 4-25

messages, creating 4-21

messages, deleting 4-22, 4-23

messages, protecting 4-22, 4-23

messages, viewing 4-22

object data 4-12

objects filter 4-8

own ship data 4-20

past position display 4-15

ROT setting 4-17

sleeping targets 1-8, 4-10

symbol brilliance 4-14

symbol color 4-14

symbols, object 4-4

symbols, physical AtoN, virtual AtoN 4-6

system messages 4-26

TT/AIS association 4-19

voyage setup 4-10

Alerts

alert box 1-70, 1-71

alert icons and meanings 1-74

alert list 1-72

ALF format AP-10

ALR format AP-16

codes and definitions AP-10

compilation AP-10

definition 1-70

Anchor watch 1-70

Automatic Clutter Elimination (ACE)

function 1-25

B

Background colors 1-60

Bearing measurement 1-35

EBL key 1-36

methods 1-36

on-screen box 1-36

true/relative 1-37

Brilliance 1-3

on-screen data 1-60

C

CCRP 1-68

Color palettes 1-60

Controls 1-1

trackball 1-2

CPA/TCPA alarm

AIS 4-18

TT 3-16

Cursor data 1-9

Custom settings 1-11

Customized echo

editing 1-29

restoring to factory default settings 1-30

restoring to saved settings 1-29

selection 1-28

Customizing operation 1-11

D

Display indications 1-4

Display mode 1-76

DRIFT 3-15

E

EA 1-24

EBL collision assessment 1-37

assess risk 1-38

set reference point 1-39

Echo average 1-24

Echo colors 1-61

Echo stretch 1-24

ES 1-24

F

False echoes

multiple echoes 2-3

shadow sectors 2-5

sidelobe echoes 2-4

virtual images 2-4

Function keys 1-10

G

GAIN 1-19

H

Heading alignment 1-12

Heading line

how to hide the heading line 1-57

I

Information box 1-63

Information box menu 1-63

Interference rejector 1-23

Interswitch 1-64

antenna information 1-64

IR 1-23

L

List of abbreviations AP-22

- Longitude error tablesAP-8
- Lost target alert
 - enable/disable alert 3-7
- M**
- Maintenance 6-1
 - major parts life expectancy 6-3
 - periodic schedule 6-2
 - trackball 6-4
- Marks
 - barge mark 1-58
 - delete marks 1-56
 - drop mark 1-59
 - hide heading line 1-57
 - how to inscribe a mark 1-56
 - how to use marks 1-54
 - INS mark 1-58
 - mark inscription position 1-55
 - mark type 1-54
 - origin mark stabilization 1-56
 - own ship symbol settings 1-57
 - radar map marks 1-58
 - show/hide radar map marks 1-58
 - show/hide stern mark 1-57
- Menu operations 1-6
 - box menus 1-7
 - context menus 1-7
 - cursor menu 1-8
 - main menu 1-6
 - menu layers 1-6
- Menu treeAP-1
- N**
- Nav data 1-62
 - display settings 1-62
 - enable/disable display 1-62
- Navigational data 1-62
- Noise rejector 1-26
- NR 1-26
- O**
- Observation
 - bearing accuracy 2-3
 - false echoes 2-3
 - min/max ranges 2-1
 - range measurement 2-3
 - resolution 2-2
- Off-center 1-42
- On-screen indications 1-4
- Orientation modes 1-31
 - description 1-31
 - selection 1-31
- Own ship position 1-14
- Own ship speed 1-12
 - auto input 1-12
 - manual input 1-13
- P**
- Parallel index lines 1-50
 - bearing and interval 1-51
 - bearing reference 1-51
 - displayed lines 1-50
 - length adjustment 1-52
 - orientation 1-51
 - reset 1-52
- Past position
 - POSN plotting intervals 3-14
- Past position display
 - AIS 4-15
 - TT 3-14
- PAST POSN 3-14
- Performance monitor 1-66
 - activate/deactivate 1-66
 - check radar performance 1-67
- PI 1-50
- PI lines 1-50
- Plotter 5-1
- PM 1-66
- Power switch 1-3
- Pulselength 1-18
 - adjustment 1-19
- R**
- RACON 2-8
- Radar map 5-1
 - disable map alignment 5-3
 - enable map alignment 5-2
 - map marks 5-2
 - show/hide map 5-1
- Radar Target Enhancer 2-8
- Rain clutter 1-21
 - manual 1-22
- Range and bearing measurement 1-39
 - how to measure 1-40
- Range measurement 1-33
 - on-screen box 1-34
 - TTG to VRM 1-35
 - VRM key 1-34
 - VRM units 1-35
- Range rings
 - hide/show rings 1-8, 1-33
- Range scale 1-33
- Reference position 1-68
- Responsibility transfer alert 1-75
- RTE 2-8
- S**
- SART 2-6
 - bandwidth 2-7
 - description 2-6
 - radar sidelobes 2-7
 - range errors 2-7
 - show/hide SART marks 2-6
- SC card 1-77
 - access data 1-77
 - delete data 1-77
 - load data 1-77
 - read data 1-77
 - save data 1-77

INDEX

- Sea clutter 1-20
 - adjustment methods 1-20
 - auto 1-20
 - manual 1-21
- Search and rescue transponder 2-6
- Second trace echoes 1-30
- Sensitivity 1-19
- SET DRIFT 3-15
- Symbols AP-27, AP-34, AP-41
 - general radar symbols AP-27
 - IMO map radar symbols AP-29
 - radar map AP-28
 - radar(AIS symbols) AP-29
 - radar(TT symbols) AP-29
- T**
- Target alarm 1-48
 - alarm settings 1-50
 - deactivate 1-49
 - mute 1-49
 - on/off 1-49
 - setting 1-49
- Target trails
 - clutter prevention 1-46
 - hide trails 1-45
 - narrow trails 1-45
 - trail erase/restart 1-45
 - trail gradation 1-44
 - trail level 1-45
 - trail stabilization 1-45
 - trail time 1-44
 - true/relative 1-43
- Terminology 1-2
- Transmission on/off 1-17
- Troubleshooting 6-1
 - advanced troubleshooting 6-5
 - basic troubleshooting 6-4
 - diagnostics 6-7
- TT
 - acquisition zone 3-17
 - acquisition zone, acknowledging alert... 3-18
 - acquisition zone, deactivating, sleeping... 3-18
 - acquisition zone, polygon 3-18
 - acquisition zone, shape, stabilization 3-19
 - acquisition, automatic 3-4
 - acquisition, manual 3-3
 - activating, deactivating tracking 3-3
 - canceling targets, all 3-6
 - canceling targets, individual 3-5
 - controls 3-2
 - CPA/TCPA alarm 3-16
 - lost target filter 3-6
 - mode 3-2
 - name feature 3-11
 - on-screen box 3-2
 - past position display 3-14
 - set and drift 3-15
 - simulation mode 3-21
 - speed, echo referenced 3-4
 - symbol brilliance 3-8
 - symbols 3-7
 - symbols, color 3-8
 - system messages 3-20
 - target data, displaying 3-9
 - target data, removing 3-9
 - target list, displaying 3-10
 - target list, hiding 3-10
 - target list, sorting 3-10
 - target selection criteria 3-22
 - usage 3-1
 - vector length 3-14
 - vector modes description 3-12
- Tuning 1-17
 - auto 1-18
 - manual 1-18
- V**
- Vector modes
 - vector time 3-14
- Video plotter 5-1
 - create waypoints 5-6
 - delete own ship's track 5-5
 - delete waypoints 5-7
 - display waypoint list 5-7
 - display waypoint name/number 5-7
 - enter waypoints 5-6
 - orientation modes 5-1
 - own ship's track 5-4
 - own ship's track color 5-4
 - own ship's track plot interval 5-4
 - radar map 5-1
 - waypoints 5-6
- W**
- Wiper 1-26
- Z**
- Zoom 1-53

Declaration of Conformity

[FAR-1513(-BB)/FAR-1523(-BB)]

- Bulgarian (BG)** С настоящото Furuno Electric Co., Ltd. декларира, че гореспоменат тип радиосъоръжение е в съответствие с Директива 2014/53/ЕС, СИ 2017/1206. Цялостният текст на ЕС/УК декларацията за съответствие може да се намери на следния интернет адрес:
- Spanish (ES)** Por la presente, Furuno Electric Co., Ltd. declara que el tipo de equipo radioeléctrico arriba mencionado es conforme con la Directiva 2014/53/UE, SI 2017/1206. El texto completo de la declaración de conformidad de la EU/UK está disponible en la siguiente dirección Internet:
- Czech (CS)** Tímto Furuno Electric Co., Ltd. prohlašuje, že výše zmíněné typ rádiového zařízení je v souladu se směrnicí 2014/53/EU, SI 2017/1206. Úplné znění EU/SK prohlášení o shodě je k dispozici na této internetové adrese:
- Danish (DA)** Hermed erklærer Furuno Electric Co., Ltd., at ovennævnte radioudstyr er i overensstemmelse med direktiv 2014/53/EU, SI 2017/1206. EU/UK-overensstemmelseserklæringens fulde tekst kan findes på følgende internetadresse:
- German (DE)** Hiermit erklärt die Furuno Electric Co., Ltd., dass der oben genannte Funkanlagentyp der Richtlinie 2014/53/EU, SI 2017/1206 entspricht. Der vollständige Text der EU/UK-Konformitätserklärung ist unter der folgenden Internetadresse verfügbar:
- Estonian (ET)** Käesolevaga deklareerib Furuno Electric Co., Ltd., et ülalmainitud raadioseadme tüüp vastab direktiivi 2014/53/EL, SI 2017/1206 nõuetele. EL/GB vastavusdeklaratsiooni täielik tekst on kättesaadav järgmisel internetiaadressil:
- Greek (EL)** Με την παρούσα η Furuno Electric Co., Ltd., δηλώνει ότι ο προαναφερθέντας ραδιοεξοπλισμός πληροί την οδηγία 2014/53/ΕΕ, SI 2017/1206. Το πλήρες κείμενο της δήλωσης συμμόρφωσης ΕΕ/UK διατίθεται στην ακόλουθη ιστοσελίδα στο διαδίκτυο:
- English (EN)** Hereby, Furuno Electric Co., Ltd. declares that the above-mentioned radio equipment type is in compliance with Directive 2014/53/EU, SI 2017/1206. The full text of the EU/UK declaration of conformity is available at the following internet address:
- French (FR)** Le soussigné, Furuno Electric Co., Ltd., déclare que l'équipement radioélectrique du type mentionné ci-dessus est conforme à la directive 2014/53/UE, SI 2017/1206. Le texte complet de la déclaration UE/RU de conformité est disponible à l'adresse internet suivante:
- Croatian (HR)** Furuno Electric Co., Ltd. ovime izjavljuje da je gore rečeno radijska oprema tipa u skladu s Direktivom 2014/53/EU, SI 2017/1206. Cjeloviti tekst EU/UK izjave o sukladnosti dostupan je na sljedećoj internetskoj adresi:
- Italian (IT)** Il fabbricante, Furuno Electric Co., Ltd., dichiara che il tipo di apparecchiatura radio menzionato sopra è conforme alla direttiva 2014/53/UE, SI 2017/1206. Il testo completo della dichiarazione di conformità UE/RU è disponibile al seguente indirizzo Internet:
- Latvian (LV)** Ar šo Furuno Electric Co., Ltd. deklarē, ka augstāk minēts radioiekārta atbilst Direktīvai 2014/53/ES, SI 2017/1206. Pilns ES/AK atbilstības deklarācijas teksts ir pieejams šādā interneta vietnē:

- Lithuanian (LT) Aš, Furuno Electric Co., Ltd., patvirtinu, kad pirmiau minėta radijo įrenginių tipas atitinka Direktyvą 2014/53/ES, SI 2017/1206.
Visas ES/JK atitikties deklaracijos tekstas prieinamas šiuo interneto adresu:
- Hungarian (HU) Furuno Electric Co., Ltd. igazolja, hogy fent említett típusú rádióberendezés megfelel a 2014/53/EU, SI 2017/1206 irányelvnek.
Az EU/EK-megfelelőségi nyilatkozat teljes szövege elérhető a következő internetes címen:
- Maltese (MT) B'dan, Furuno Electric Co., Ltd., niddikjara li msemmija hawn fuq-tip ta' taghmir tar-radju huwa konformi mad-Direttiva 2014/53/UE, SI 2017/1206.
It-test kollu tad-dikjarazzjoni ta' konformità tal-UE/RU huwa disponibbli f'dan l-indirizz tal-Internet li ġej:
- Dutch (NL) Hierbij verklaar ik, Furuno Electric Co., Ltd., dat het hierboven genoemde type radioapparaat conform is met Richtlijn 2014/53/EU, SI 2017/1206.
De volledige tekst van de EU/VK-conformiteitsverklaring kan worden geraadpleegd op het volgende internetadres:
- Polish (PL) Furuno Electric Co., Ltd. niniejszym oświadcza, że wyżej wymieniony typ urządzenia radiowego jest zgodny z dyrektywą 2014/53/UE, SI 2017/1206.
Pełny tekst deklaracji zgodności UE/UK jest dostępny pod następującym adresem internetowym:
- Portuguese (PT) O(a) abaixo assinado(a) Furuno Electric Co., Ltd. declara que o mencionado acima tipo de equipamento de rádio está em conformidade com a Diretiva 2014/53/UE, SI 2017/1206.
O texto integral da declaração de conformidade da EU/UK está disponível no seguinte endereço de Internet:
- Romanian (RO) Prin prezenta, Furuno Electric Co., Ltd. declară că echipamentul radio menționat mai sus este în conformitate cu Directiva 2014/53/UE, SI 2017/1206.
Textul integral al declarației de conformitate UE/RU este disponibil la următoarea adresă internet:
- Slovak (SK) Furuno Electric Co., Ltd. týmto vyhlasuje, že vyššie spomínané rádiové zariadenie typu je v súlade so smernicou 2014/53/EÚ, SI 2017/1206.
Úplné EÚ/SK vyhlásenie o zhode je k dispozícii na tejto internetovej adrese:
- Slovenian (SL) Furuno Electric Co., Ltd. potrjuje, da je zgoraj omenjeno tip radijske opreme skladen z Direktivo 2014/53/EU, SI 2017/1206.
Celotno besedilo izjave EU/ZK o skladnosti je na voljo na naslednjem spletnem naslovu:
- Finnish (FI) Furuno Electric Co., Ltd. vakuuttaa, että yllä mainittu radiolaitetyyppi on direktiivin 2014/53/EU, SI 2017/1206 mukainen.
EU/UK-vaatimustenmukaisuusvakuutuksen täysimittainen teksti on saatavilla seuraavassa internetosoitteessa:
- Swedish (SV) Härmed försäkrar Furuno Electric Co., Ltd. att ovan nämnda typ av radioutrustning överensstämmer med direktiv 2014/53/EU, SI 2017/1206.
Den fullständiga texten till EU/Storbritannien-försäkran om överensstämmelse finns på följande webbadress:

Online Resource

http://www.furuno.com/en/support/red_doc

Notice for radiated immunity

The test for the radiated immunity is performed up to 2.7 GHz only without the special condition of spot frequency being applied. There is a chance that this equipment may interfere with allocated services in the frequency range of 2.7 GHz to 6 GHz, particularly in harbors, rivers, lake banks, etc.



0575

Declaration of Conformity



0097

We **FURUNO ELECTRIC CO., LTD.**

(Manufacturer)

9-52 Ashihara-Cho, Nishinomiya City, 662-8580, Hyogo, Japan

(Address)

declare under our sole responsibility that the product

MARINE RADAR
FAR-1518, FAR-1528, FAR-1518-BB and FAR-1528-BB
(Serial No. 1000-37xx/1001-46xx-xxxx)

(Model name, type number)

to which this declaration relates conforms to the following standard(s) or other normative document(s)

EU

Directive 2014/90/EU on Marine Equipment (MED) as amended the Implementing Regulation (EU) 2023/1667

SOLAS 74 Reg. V/18, V/19 & X/3
IMO Res. MSC.36(63), MSC.97(73), A.278(VIII),
A.694(17), MSC.191(79), MSC.192(79),
MSC.302(87), MSC.1/Circ.1349
ITU-R M.1177-4

UK

UK MCA Merchant Shipping (Marine Equipment) Regulations 2016 (MER) as amended MSN 1874 Amendment 7

SOLAS 74 Reg. V/18, V/19 & X/3
IMO Res. MSC.36(63), MSC.97(73), A.278(VIII),
A.694(17), MSC.191(79), MSC.192(79),
MSC.302(87), MSC.1/Circ.1349
ITU-R M.1177-4

(title and number of the requirements)

For assessment, see

- EC-type examination certificate (Module B)
MEDB00000FC Rev.11: DNV AS (0575)
- Product Quality System certificate (Module D)
MEDD00002CD Rev.5: DNV AS (0575)

For assessment, see

- UK-type examination certificate (Module B)
MERB00000FC Rev.1: DNV UK Ltd. (0097)
- Product Quality System certificate (Module D)
MERD00002CD Rev.3: DNV UK Ltd. (0097)

On behalf of Furuno Electric Co., Ltd.

Nishinomiya City, Japan
4 December 2023

(Place and date of issue)

Akihiko Kanechika
Department General Manager
Quality Assurance Department

(name and signature or equivalent marking of authorized person)