

FURUNO

OPERATOR'S MANUAL

SSB RADIOTELEPHONE

FS-1570

FS-2570

Model **FS-5070**

ECF

(Elemental Chlorine Free)

The paper used in this manual
is elemental chlorine free.

FURUNO ELECTRIC CO., LTD.

9-52 Ashihara-cho,
Nishinomiya, 662-8580, JAPAN

• FURUNO Authorized Distributor/Dealer

All rights reserved. Printed in Japan

Pub. No. OME-56560-E

(YOTA) FS-5070/1570/2570

A : NOV. 2006

E : AUG. 03, 2012



* 0 0 0 1 6 0 5 0 1 1 4 *

IMPORTANT NOTICE

General

- This manual has been authored with simplified grammar, to meet the needs of international users.
- The operator of this equipment must read and follow the descriptions in this manual. Wrong operation or maintenance can cancel the warranty or cause injury.
- Do not copy any part of this manual without written permission from FURUNO.
- If this manual is lost or worn, contact your dealer about replacement.
- The contents of this manual and equipment specifications can change without notice.
- The example screens (or illustrations) shown in this manual can be different from the screens you see on your display. The screens you see depend on your system configuration and equipment settings.
- Save this manual for future reference.
- Any modification of the equipment (including software) by persons not authorized by FURUNO will cancel the warranty.
- All brand and product names are trademarks, registered trademarks or service marks of their respective holders.

How to discard this product

Discard this product according to local regulations for the disposal of industrial waste. For disposal in the USA, see the homepage of the Electronics Industries Alliance (<http://www.eiae.org/>) for the correct method of disposal.

How to discard a used battery

Some FURUNO products have a battery(ies). To see if your product has a battery, see the chapter on Maintenance. Follow the instructions below if a battery is used. Tape the + and - terminals of battery before disposal to prevent fire, heat generation caused by short circuit.

In the European Union

The crossed-out trash can symbol indicates that all types of batteries must not be discarded in standard trash, or at a trash site. Take the used batteries to a battery collection site according to your national legislation and the Batteries Directive 2006/66/EU.

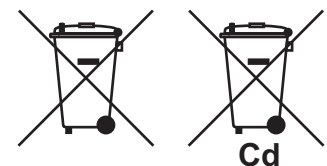

In the USA

The Mobius loop symbol (three chasing arrows) indicates that Ni-Cd and lead-acid rechargeable batteries must be recycled. Take the used batteries to a battery collection site according to local laws.





In the other countries

There are no international standards for the battery recycle symbol. The number of symbols can increase when the other countries make their own recycling symbols in the future.



SAFETY INSTRUCTIONS

The user and installer must read the appropriate safety instructions before attempting to install or operate the equipment.

 DANGER	Indicates a hazardous situation which, if not avoided, will result in death or serious injury.
 WARNING	Indicates a potentially hazardous situation which, if not avoided, could result in death or serious injury.
 CAUTION	Indicates a potentially hazardous situation which, if not avoided, may result in minor or moderate injury.

 Warning, Caution	 Prohibitive Action	 Mandatory Action
--	--	--

 DANGER

Never touch the SSB antenna, antenna coupler or lead-in insulator when the SSB radiotelephone is transmitting.

High voltage which will cause death or serious injury is present at the locations shown in the illustration below when the SSB radiotelephone is transmitting.

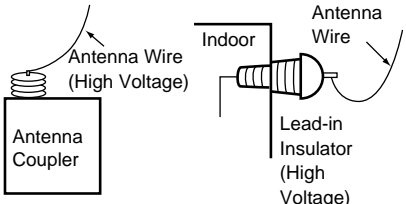



 WARNING

 **Do not open the equipment.**
Only qualified personnel should work inside the equipment.

 **Immediately turn off the power at the switchboard if water leaks into the equipment or something is dropped into the equipment.**
Continued use of the equipment can cause fire or electrical shock. Contact a FURUNO agent for service.

 **Do not disassemble or modify the equipment.**
Fire, electrical shock or serious injury can result.

 WARNING

 **Immediately turn off the power at the switchboard if the equipment is emitting smoke or fire.**
Continued use of the equipment can cause fire or electrical shock. Contact a FURUNO agent for service.

 **Do not place liquid-filled containers on the top of the equipment.**
Fire or electrical shock can result if a liquid spills into the equipment.

 **Do not operate the equipment with wet hands.**
Electrical shock can result.

 **Turn off the power immediately if you feel the equipment is behaving abnormally.**
Turn off the power at the switchboard if the equipment becomes abnormally warm or is emitting odd noises. Contact a FURUNO dealer or agent for advice.

 **Make sure no rain or water splash leaks into the equipment.**
Fire or electrical shock can result if water leaks in the equipment.

 **Use the proper fuse.**
Use of the wrong fuse can cause fire or electrical shock.

⚠ WARNING

⊘ Do not operate the [DISTRESS] button except in case of a life-endangering situation on your vessel.

Operating the [DISTRESS] button transmits the distress alert. Accidental transmission may prevent search and rescue operations for actual emergency. If the distress alert is accidentally transmitted, contact the nearest station to cancel the alert.

⚠ CAUTION

! If the distress alert is accidentally transmitted, contact the nearest coast station and inform them of the accidental transmission, providing the following data:

- a) Ship's name
- b) Ship's call sign and DSC number
- c) Position at time of transmission
- d) Time of transmission

⊘ Do not apply strong pressure to the LCD, which is made of glass.

Injury can result if the LCD breaks.

WARNING LABEL(S)

**Do not remove any safety label.
If a label is missing or damaged, contact a FURUNO agent or dealer about replacement.**

⚠ DANGER 	Hazardous voltage. Can shock, burn, or cause death.
	Do not touch antenna wire, insulator and terminal.

Name: Danger Label
Type: 05-062-0213-0
Code No.: 100-199-230

ANTENNA
COUPLER

⚠ WARNING ⚠	
To avoid electrical shock, do not remove cover. No user-serviceable parts inside.	
⚠	⚠

Name: Warning Label (1)
Type: 86-003-1011
Code No.: 100-236-231

TRANSCIVER
UNIT

DISTRESS ALERT MESSAGE PROCEDURE

Below is the procedure for transmitting a distress alert via radiotelephone. Transmit the distress alert when a life-endangering situation occurs on your vessel.

1. Open the **DISTRESS** button cover and press the **DISTRESS** button more than four seconds to show the following display, then release the **DISTRESS** button.

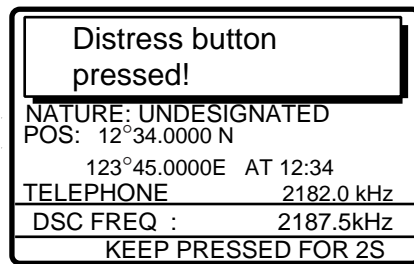

2. After the distress message has been transmitted, the following displays appear in order.

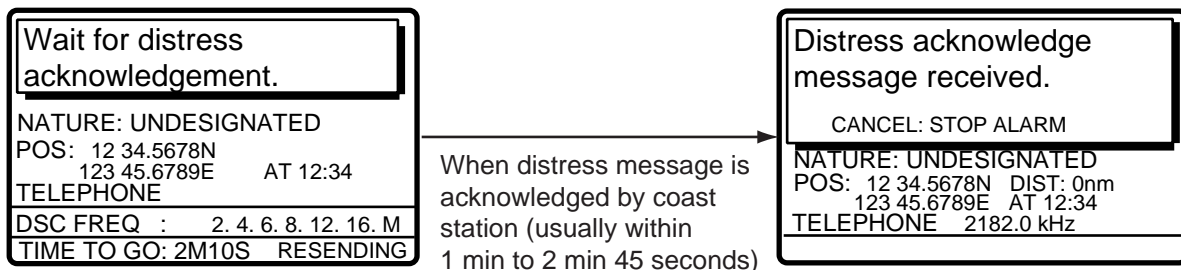

3. The audio alarm sounds; press the **CANCEL** key to silence the alarm.
4. Communicate with the coast station via radiotelephone as below.

Say MAYDAY three times.

Say "This is ..." name of your vessel and your message sign three times.

Give nature of distress and assistance needed.

Give description of your vessel (type, number of persons onboard, etc.) and any other information which may aid in rescue.

Note: If the distress message is not acknowledged by coast station, it will be transmitted again after 3 min 30 seconds to 4 min 30 seconds.

For IC-302 (option) operation

1. Open the **DISTRESS** button cover and press the **DISTRESS** button more than four seconds.
2. After the distress message has been transmitted, the length of the beep changes from short to long.
3. Release the **DISTRESS** button.
4. Do step 4 shown in the Distress Alert Message Procedure above with the radiotelephone.

CANCELING DISTRESS ALERT

You can cancel the distress call while it is being sent or while waiting for its acknowledgement as follows.

1. Press the **CANCEL** key.

When the following message appears, do the following.

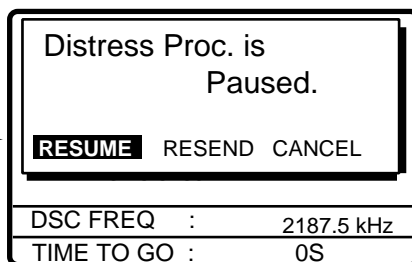

2. Rotate the **ENTER** knob to choose **CANCEL** at the screen, and then push the **ENTER** knob.

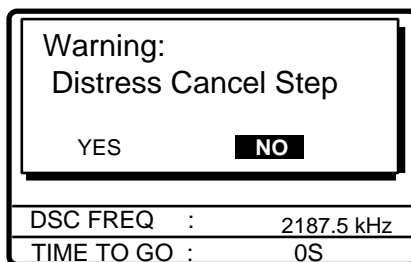

3. Rotate the **ENTER** knob to choose **YES**, and then push the **ENTER** knob to show the following screen.

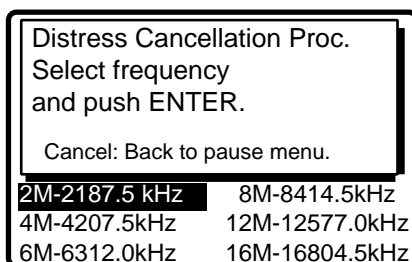

The cancellation message is transmitted over the same frequency used to transmit the distress call.

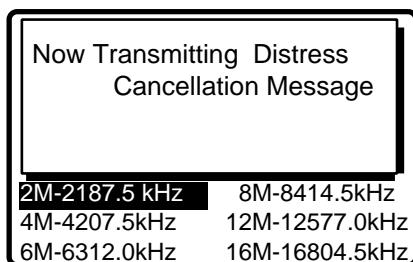

CANCELLING DISTRESS ALERT

4. Communicate, via radiotelephone, with the coast station.

Send cancel msg. by voice on 2182.0 kHz.	
Push any key: Go next step.	
*2M-2187.5 kHz	8M-8414.5kHz
4M-4207.5kHz	12M-12577.0kHz
6M-6312.0kHz	16M-16804.5kHz

Asterisk marks the frequency over which the cancellation call was transmitted..

5. Press any key.

If you used other frequencies to send the distress call, cancel distress call on those frequencies by repeating steps 3 to 5.

When all cancellation is completed, the RT display appears.

TABLE OF CONTENTS

FOREWORD	xii
SYSTEM CONFIGURATIONS	xiv
1. OPERATIONAL OVERVIEW	1-1
1.1 Controls.....	1-1
1.2 Turning the Power On/Off	1-2
1.3 Radiotelephone (RT) Screen	1-2
1.4 DSC Standby Screen.....	1-3
1.5 Control Unit Dimmer, Contrast	1-4
1.6 Loudspeaker.....	1-4
1.7 Setting Scan Frequencies.....	1-4
1.8 Setting for Auto Acknowledgement	1-5
1.9 System Characteristics	1-5
1.9.1 Equipment priority	1-5
1.9.2 Controls become inoperative.....	1-5
1.9.3 Controls become operative.....	1-5
1.9.4 Automatic setting of working frequency	1-6
1.10 Intercom	1-6
2. SSB RADIOTELEPHONE	2-1
2.1 Choosing Class of Emission	2-1
2.2 Choosing Channel, Frequency	2-2
2.3 Transmitting.....	2-3
2.3.1 Transmitting procedure.....	2-3
2.3.2 Reducing transmitter power.....	2-4
2.3.3 Condition of the transmitting unit	2-4
2.4 Receiving.....	2-5
2.4.1 RF gain (sensitivity) adjustment.....	2-5
2.4.2 S-meter	2-5
2.4.3 Receiving AM broadcasting stations.....	2-6
2.4.4 Squelch function.....	2-6
2.4.5 Noise blanker	2-6
2.5 When Automatic Tuning Fails	2-7
2.6 User Channels.....	2-8
3. DSC OVERVIEW	3-1
3.1 What is DSC?	3-1
3.2 DSC Message	3-1
3.3 Audio Alarms	3-3
3.4 Interpreting Call Displays	3-4
3.4.1 Receive calls	3-4

TABLE OF CONTENTS

3.4.2	Send calls	3-5
4.	DISTRESS OPERATIONS	4-1
4.1	Sending Distress Alert.....	4-1
4.1.1	Sending distress alert by DISTRESS button, nature of distress not specified .	4-2
4.1.2	Sending distress alert by DISTRESS button, nature of distress specified	4-4
4.2	Receiving a Distress Alert.....	4-7
4.2.1	Distress alert received on MF band.....	4-7
4.2.2	Distress alert received on HF band	4-10
4.3	Sending Distress Relay on Behalf of a Ship in Distress	4-14
4.3.1	Sending distress relay to coast station	4-14
4.3.2	Sending distress relay to area ships	4-18
4.4	Receiving Distress Relay from Coast Station.....	4-21
4.5	Cancelling Distress Call	4-21
5.	ROUTINE MESSAGE CALLING, RECEIVING	5-1
5.1	Individual Call.....	5-1
5.1.1	Sending an individual call.....	5-1
5.1.2	Receiving an individual call	5-7
5.2	Group Call.....	5-12
5.2.1	Sending a group call	5-12
5.2.2	Receiving a group call.....	5-14
5.3	Geographical Area Call	5-15
5.3.1	Sending a geographical area call	5-16
5.3.2	Receiving a geographical area call	5-17
5.4	Neutral Craft Call.....	5-19
5.4.1	Sending a neutral craft call.....	5-19
5.4.2	Receiving a neutral craft call	5-20
5.5	Medical Transport Call.....	5-21
5.5.1	Sending a medical transport call	5-21
5.5.2	Receiving a medical transport call.....	5-23
5.6	Receiving a Polling Request.....	5-24
5.6.1	Automatic reply	5-24
5.6.3	Manual reply	5-25
5.7	Position Call	5-26
5.7.1	Requesting other ship's position	5-26
5.7.2	Position call: other ship requests your position.....	5-28
5.8	PSTN Call	5-30
5.8.1	Sending a PSTN call, receiving acknowledge back (ACK BQ)	5-30
5.8.2	Receiving a PSTN call, sending acknowledge back (ACK BQ)	5-33
5.8.3	PSTN call disconnection, receiving charge information (ship disconnects line).....	5-35
5.8.4	PSTN call disconnection, receiving charge information (coast station disconnects line)	5-36
5.9	Log File	5-36
5.9.1	Opening a log file.....	5-36
5.9.2	Deleting log files	5-37

6. MENU OPERATION	6-1
6.1 Adjusting Handset Volume	6-1
6.2 Noise Blanker	6-2
6.3 Squelch Frequency.....	6-2
6.4 User Channels.....	6-2
6.4.1 Registering user channels.....	6-2
6.4.2 Deleting user channels.....	6-4
6.5 Preparing TX Message	6-4
6.5.1 Preparing individual calls.....	6-4
6.5.2 Preparing group calls	6-7
6.5.3 Preparing PSTN calls	6-9
6.5.4 Preparing test call.....	6-10
6.5.5 Sending prepared messages.....	6-11
6.5.6 Deleting send message.....	6-11
6.5.7 Printing List of Send Message Files	6-12
6.6 Manual Entry of Position and Time	6-12
6.7 Date and Time Setting	6-14
6.8 Memory Clear	6-14
6.9 Setting Alarms	6-16
6.10 Sound Setting.....	6-17
6.11 Setting the AUTO ACK Details	6-18
6.12 Printing Messages	6-19
6.13 Setting Scan Frequencies.....	6-20
6.14 Key Assignment.....	6-22
6.15 Special Messages.....	6-22
6.16 FAX Enable/Disable.....	6-23
6.17 Speaker Setting in Off Hook.....	6-23
6.18 Operation Timer Off	6-23
7. NBDP SYSTEM OVERVIEW.....	7-1
7.1 Turning on the NBDP System	7-1
7.2 Description of Equipment.....	7-2
7.2.1 Terminal unit.....	7-2
7.2.2 Keyboard.....	7-3
7.3 Function Keys, Menu Operation.....	7-4
7.3.1 Menu conventions	7-4
7.3.2 Menu overview	7-5
7.3.3 Function key description.....	7-6
8. NBDP PREPARATIONS.....	8-1
8.1 Registering Answerback Code & ID Codes	8-1
8.1.1 Registering answerback code	8-1
8.1.2 Registering ID codes	8-2
8.2 Station List.....	8-3
8.2.1 Registering stations.....	8-3
8.2.2 Editing/Deleting stations.....	8-4
8.3 Timer Programming	8-5
8.3.1 Registering timer programs	8-5

TABLE OF CONTENTS

8.3.2	Editing/Deleting timer programs	8-6
8.4	User Channels	8-6
8.4.1	Registering user channels.....	8-6
8.4.2	Editing/Deleting user channels.....	8-7
8.5	Scan Channel Groups	8-7
8.5.1	Registering scan channel groups	8-7
8.5.2	Editing/Deleting scan channel groups	8-8
9.	NBDP FILE OPERATIONS	9-1
9.1	Opening and Closing Files	9-1
9.2	Creating Files	9-1
9.3	Saving a File	9-2
9.3.1	Formatting floppy disks	9-2
9.3.2	Saving a file	9-3
9.4	Editing Files.....	9-3
9.4.1	Cutting and pasting text	9-3
9.4.2	Copying and pasting text.....	9-4
9.4.3	Select all	9-5
9.4.4	Searching text.....	9-5
9.4.5	Replacing text.....	9-6
9.4.6	Goto line	9-6
9.4.7	Goto top, Goto bottom	9-6
9.5	Opening Files	9-7
9.5.1	Opening a file.....	9-7
9.5.2	Switching between files.....	9-7
9.6	Renaming Files	9-7
9.7	Saving a File Under a New Name	9-8
9.8	Deleting Files	9-8
9.9	Real Time Printing.....	9-8
9.10	Printing Files	9-8
10.	NBDP TRANSMITTING, RECEIVING.....	10-1
10.1	Manual Calling	10-1
10.2	ARQ Mode Operation.....	10-3
10.3	FEC Mode Operation	10-5
10.4	Choosing Receive Mode	10-5
10.5	Communication Example.....	10-6
10.6	Timer Operation	10-8
10.6.1	Enabling timer operation	10-8
10.6.2	Stopping timer operation	10-9
10.7	Scanning	10-9
10.8	Communication Buffer.....	10-10
10.9	Preparing Macrofiles for Automatic Telex.....	10-10
10.9.1	Automatic telex overview	10-10
10.9.2	Preparations	10-11
10.9.3	Commands	10-12
10.9.4	Store-and-forward method	10-13
10.10	Automatic Telex using Macrofile	10-17

11. MAINTENANCE & TROUBLESHOOTING	11-1
11.1 Radiotelephone Test.....	11-1
11.2 Maintenance	11-2
11.3 Simple Troubleshooting	11-3
11.4 Error Messages	11-4
11.5 Replacement of Fuses	11-5
11.6 Test Call.....	11-6
11.7 NBDP Terminal Unit Maintenance.....	11-8
11.7.1 Cleaning the equipment	11-8
11.7.2 Connectors and earth connection.....	11-8
11.7.3 Floppy disk drive	11-8
11.7.4 Diagnostics	11-9
11.7.5 Notification messages.....	11-11
APPENDIX	AP-1
Menu Tree	AP-1
NBDP terminal unit (telex)	AP-2
Frequency Tables.....	AP-3
Digital Interface (IEC 61162-1).....	AP-17
Parts List.....	AP-22
Parts Location.....	AP-26
SPECIFICATIONS.....	SP-1
INDEX.....	IN-1

FOREWORD

Thank you for purchasing the FS-1570/2570/5070 SSB Radiotelephone. We are confident you will discover why FURUNO has become synonymous with quality and reliability.

Since 1948, FURUNO Electric Company has enjoyed an enviable reputation for innovative and dependable marine electronics equipment. This dedication to excellence is furthered by our extensive global network of agents and dealers.

Please carefully read and follow the safety information and operating and maintenance instructions set forth in this manual before attempting to operate the equipment and conduct any maintenance. Your unit will perform to the utmost of its ability only if it is operated and maintained in accordance with the correct procedures.

Features

The FS-1570/2570/5070 is an MF/HF SSB Radiotelephone with a built-in DSC/Watch Receiver, all contained in a surprisingly compact cabinet. An NBDP (Narrow Band Direct Printing) Terminal Unit is optionally available.

Data is displayed on a large, easy-to-read backlit LCD. Operation is simplified by the use of few keys and easy-to-follow menus.

The built-in DSC/watch receiver produces and receives digital selective calls for quick and efficient establishment of distress, urgency, safety and routine communications with other ships and coast stations that install any MF/HF DSC facilities.

The main features are

General

Fully meets the following regulations: IMO A.806(19), IMO A.694(17), IMO A. 813(19), MSC 68(68) Annex 3, IEC 61097-3 Annex A, IEC 61162-1 (2000), IEC 60945 (2002), EN 300 373-1 (2002), ETS 300 067A1(1998), EN 300 338(2004), EN 301 033 (2005), ITU-R M.493-11, M.541-9, M.476-5, M.491-1, M.492-6, M.625-3, M.1173-3.

- Automatic entry of position with manual override

Optional printer can automatically print out DSC and NBDP received messages and test results.

SSB

- Receiving voice communication, telex and AM.
- Facsimile signal receiving
- Simplified setting of channel and frequency.

DSC/watch receiver

- Distress, urgency, safety and routine calling
- Scanning of DSC frequencies for distress and general calls on MF/HF
- File editing capability for readiness in case of emergency
- PSTN (Public Switched Telephone Network) capability standard
- Log stores 50 each of latest ordinary, distress and transmitted messages, in separate memory blocks.

NBDP (with optional NBDP Terminal Unit IB-583)

- Automatic error-free telex communications and distress message in compliance with GMDSS requirements
- LCD monitor and keyboard comply with ITU regulations
- Pop-up menus for user-friendly operation
- Memory for 256 operator-customized channels
- Real time message printing with Printer PP-510

Program Number**FS-1570/2570/5070**

PC board	Program No.	Ver. No.	Remarks
MAIN	0550225	01	Main program
PANEL	0550222	01	Program for the control display
DSP (DSC)	0550207	01	MODEM Program for DSC
NBDP	0550208	01	MODEM Program for NBDP

Terminal Unit IB-581 (optional unit, for FS-1570/2570 only)

PC Board	Program No.	Ver. No	Remarks
TERMINAL	0550210	1.22	

Terminal Unit IB-583 (optional unit)

Program	Program No.	Ver. No	Remarks
TERMINAL	0550209	1.22	

About the TFT LCD: The TFT LCD is constructed using the latest LCD techniques, and displays 99.99% of its pixels. The remaining 0.01% of the pixels may drop out or blink, however this is not an indication of malfunction.

SYSTEM CONFIGURATIONS

FS-1570

Standard configuration is shown with solid line.

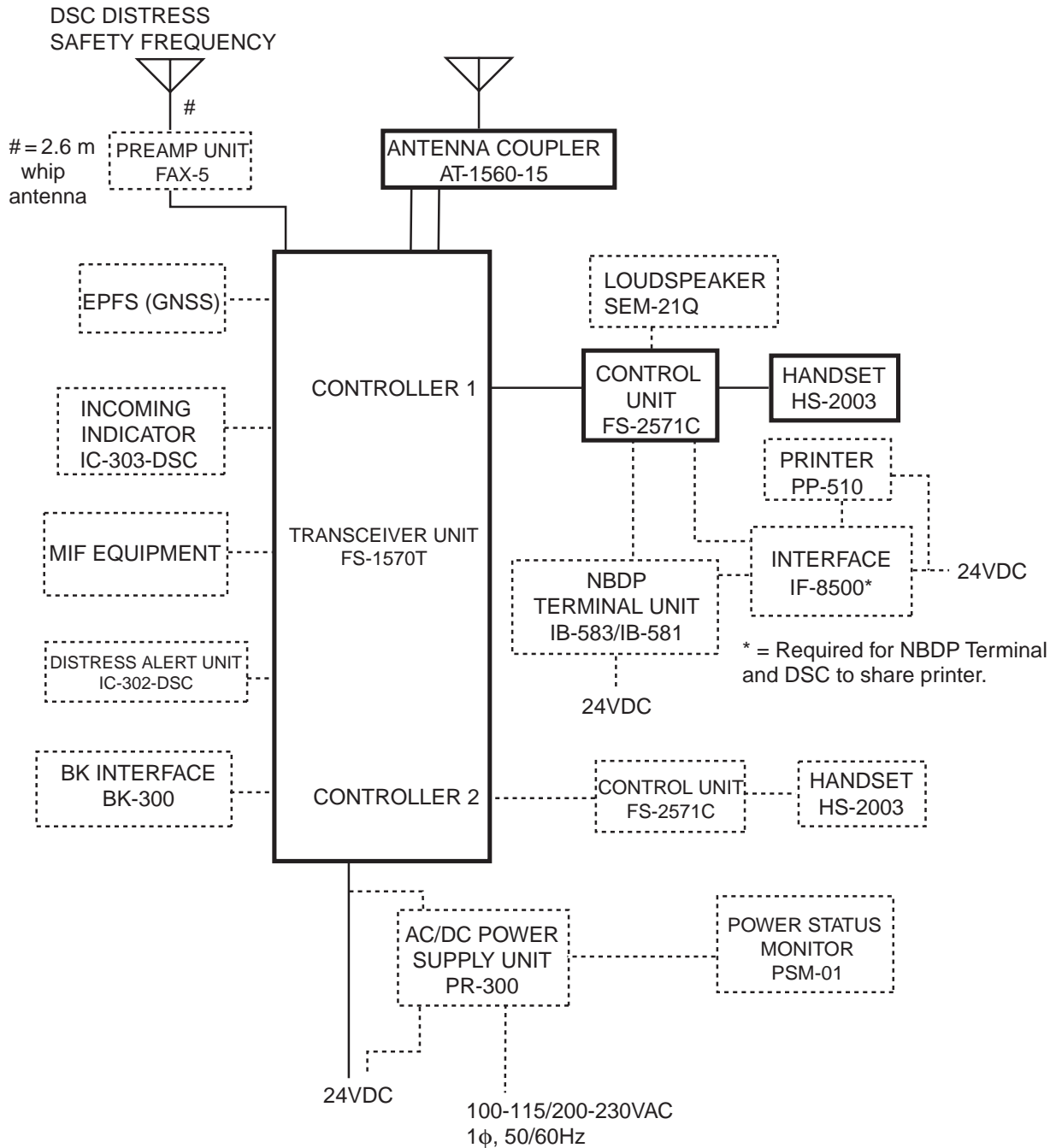

Unit	Category
Preamp Unit	Exposed to weather
Antenna Coupler	Exposed to weather
Other Units	Protected from weather

FS-2570

Standard configuration is shown with solid line.

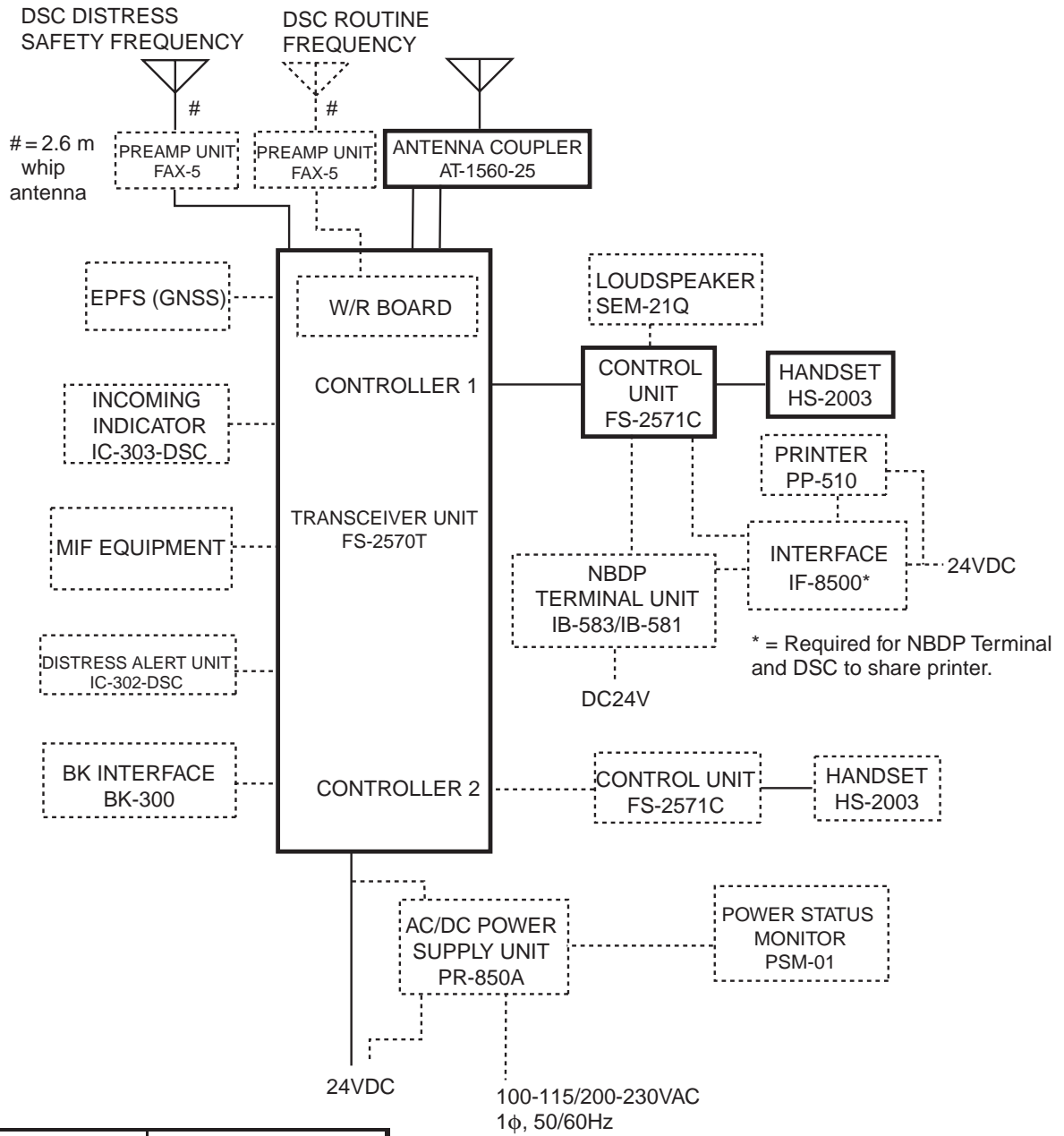

Unit	Category
Preamp Unit	Exposed to weather
Antenna Coupler	Exposed to weather
Other Units	Protected from weather

SYSTEM CONFIGURATIONS

FS-5070

Standard configuration is shown with solid line.

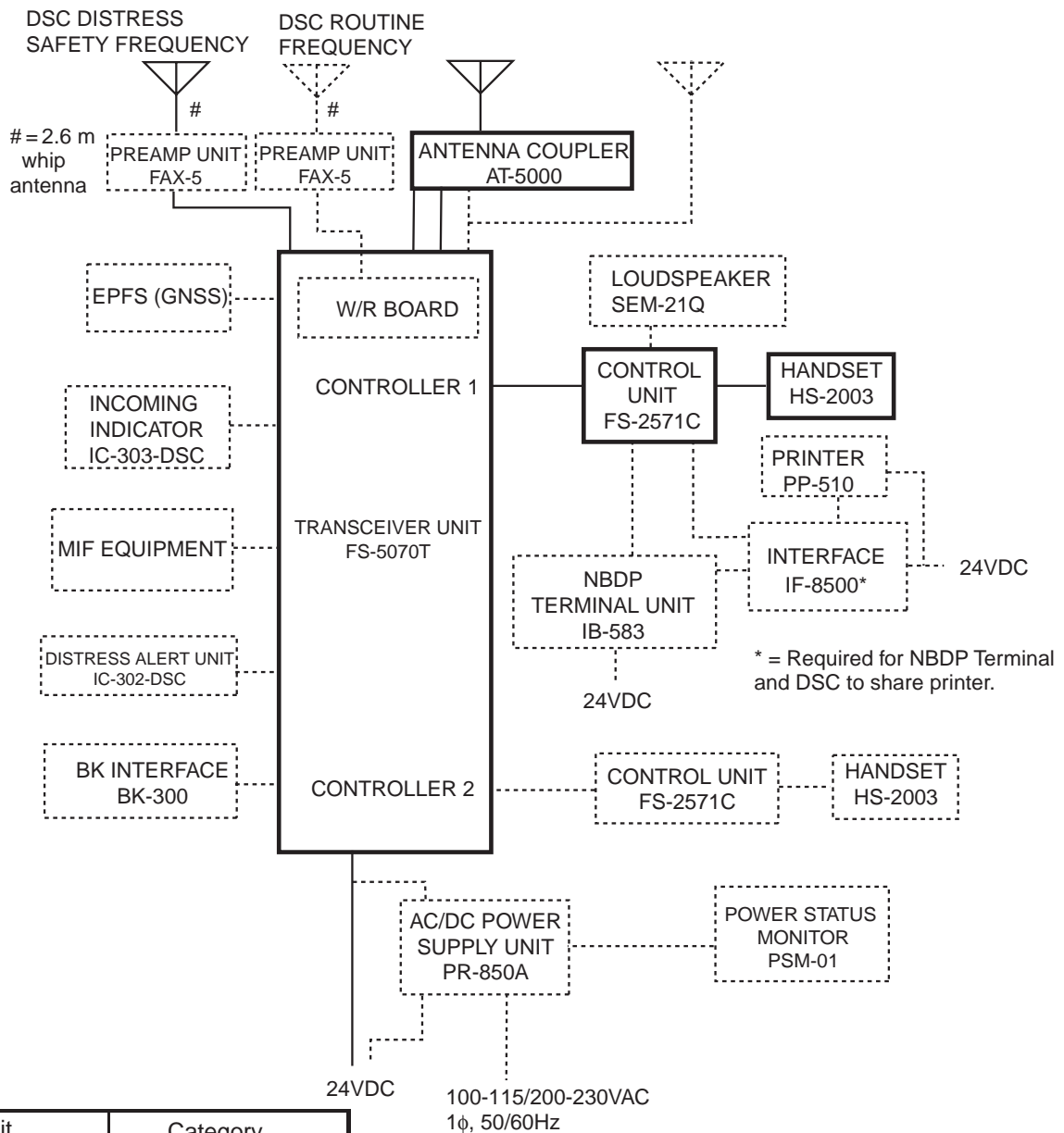

* = Required for NBBDP Terminal and DSC to share printer.

Unit	Category
Preamplifier Unit	Exposed to weather
Antenna Coupler	Exposed to weather
Other Units	Protected from weather

1. OPERATIONAL OVERVIEW

1.1 Controls

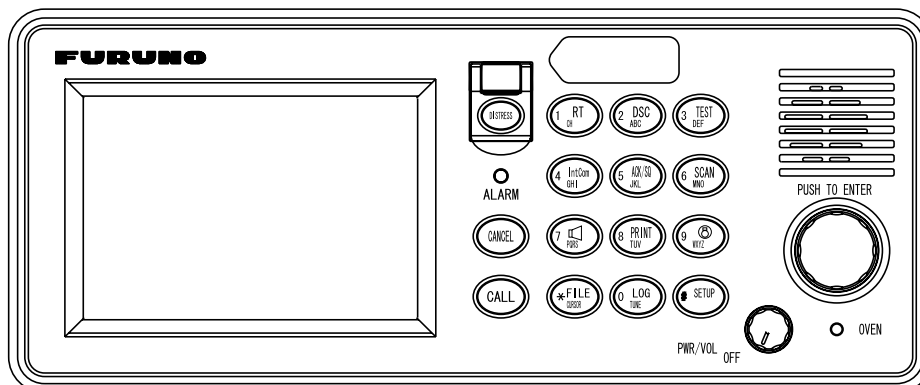

Description of controls

Control	Function
PWR/VOL knob	<ul style="list-style-type: none"> • Turns the power on/off. • Adjusts volume.
DISTRESS button	Press and hold down the button more than four (4) seconds to transmit the distress alert.
CALL key	Transmits DSC messages.
ENTER knob	Rotate to choose menu items; push to register selection.
CANCEL key	<ul style="list-style-type: none"> • Cancels wrong data. • Restores previous menu. • Silences audio alarm. • Cancels transmission, printing. • Erases error message.
1/ RT/CH key	Switches to the radiotelephone (RT) screen. Press and hold down more than five (5) seconds to set SSB: 2182.0 kHz/J3E.
2/DSC key	Composes DSC TX message.
3/TEST key	Executes daily test and TX self-check.
4/IntCom key	Turns on/off the intercom with other Control Unit FS-2571C.
5/ ACK/SQ key	DSC: Switches automatic and manual acknowledge alternately. Radiotelephone: Turns squelch on and off.
6/SCAN key	<ul style="list-style-type: none"> • Displays DSC screen. • Starts/stops scanning of DSC routine frequencies, on the DSC standby screen.

1. OPERATIONAL OVERVIEW

7/🔊 key	Turns loudspeaker on/off. (Note that this key does not silence the distress or urgency alarm.)
8/PRINT key	Prints communications log files, current screen (except DSC standby screen and radiotelephone screen) and test results.
9/☼ key	Adjusts panel dimmer and LCD contrast.
*/FILE/CURSOR key	<ul style="list-style-type: none"> • Opens the send message file list from the DSC standby screen, to send stored message. • Shifts cursor.
0/LOG/TUNE key	<ul style="list-style-type: none"> • Long press: Tunes antenna in radiotelephone operation. • Momentary press: Displays message logs.
#/SETUP key	Opens the main menu.
ALARM lamp	<ul style="list-style-type: none"> • Flashes in red for distress and urgency messages. • Flashes in green for safety and routine messages.
OVEN lamp	Lights (in green) when mains switchboard is on.

1.2 Turning the Power On/Off

Turn the **PWR/VOL** knob clockwise at the right-hand side of the control unit to power the system. The RT screen appears.

Rotate the **PWR/VOL** knob counterclockwise to turn the system off.

In the dual control unit system, the control unit connected to the CONTROLLER 1 port on the transceiver unit has priority and it controls the power for both the No.1 and No. 2 control units. The power switch of the No. 2 control unit powers on/off the No. 2 control unit only.



Note: Turn on power at switchboard more than five minutes before turning on this equipment.

1.3 Radiotelephone (RT) Screen

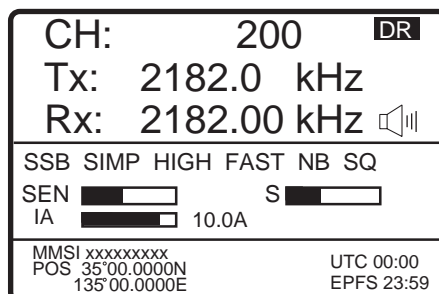
Turn the power on, or press the **1/ RT/CH** key to show the radiotelephone screen. This is where you set up the transceiver unit, and communicate by voice or telex.



Radiotelephone (RT) screen

Indication	Meaning
CH	Channel
Tx	TX frequency (Tx: while transmitting)
Rx	RX frequency
	Blinks when there are messages not read yet.
DR/DS	DR: Distress received, DS: Distress sent
	Speaker on/off
SSB/TLX/AM	Class of Emission
SIMP/SDUP/DUP	Communication mode (SIMP: simplex, SDUP: semi-duplex, DUP: full-duplex)
HIGH/MID/LOW1/LOW2	Output power (LOW2: FS-5070 only, minimum output power)
FAST/SLOW/OFF (AGC)	Auto gain control (FAST: high-speed, SLOW: low-speed, OFF: no adjustment)
NB	Noise blanker
SQ	Squelch
SEN	Receiving sensitivity
S	S-meter, displays the strength of received signal.
IA/IC/VC/RF	Transceiver unit status (IA: antenna current, IC: collector current, VC: collector voltage, RF: PA output)
MMSI	Own ship's ID (nine digits)
POS	Own ship's position
EPFS/MAN	Own ship's position data source EPFS: GPS navigator MAN: manual (See section 6.6.)

1.4 DSC Standby Screen

The DSC standby screen may be displayed by pressing the **6/SCAN** key. This screen scans and receives the distress and routine frequencies, and sends the acknowledgement for the received message automatically.

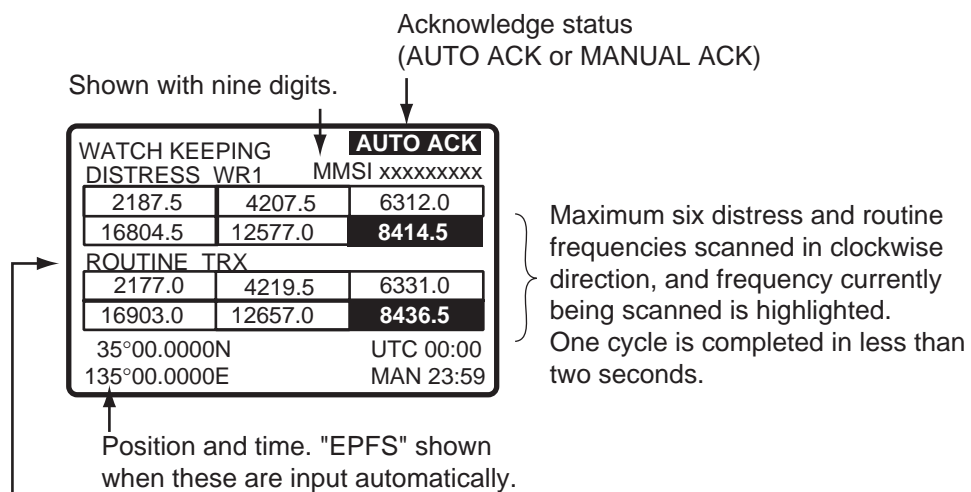

TRX: transceiver unit
WR2: The optional antenna for the routine frequency

DSC standby screen

1.5 Control Unit Dimmer, Contrast

You can adjust the dimmer and contrast of the control unit.

1. Press the **9/☼** key to show the dimmer/contrast adjustment window.

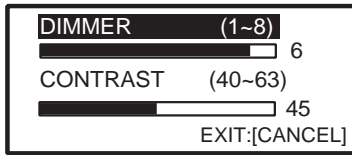

2. Rotate the **ENTER** knob to choose DIMMER or CONTRAST, whichever you want to adjust, and then push the **ENTER** knob.

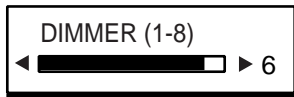

Dimmer adjustment window

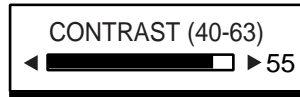

Contrast adjustment window

3. Rotate the **ENTER** knob to adjust and then push the **ENTER** knob.
4. To quit, push the **CANCEL** key.

1.6 Loudspeaker

The alarm beeps (other than distress communication) can be turned on or off.

1. Press the **7/🔊** key to alternately disable or enable the loudspeaker and the alarm generated for routine messages. SPEAKER ON or SPEAKER OFF appears with each press.
2. Rotate the PWR/VOL knob to adjust volume of loudspeaker (cw: volume up, ccw: volume down).

1.7 Setting Scan Frequencies

The DSC screen scans multiple routine frequencies according to operator-set interval. For how to set frequency to scan, see section 6.13.

Note that voice and telex communication are not available when scanning. (However, they are available when the system is equipped with the optional watch receiver.)

1. Press the **6/SCAN** key to show the DSC screen. Scanning starts.
2. Press the **6/SCAN** key again when the desired frequency is chosen to stop the cursor. You can scan only the frequency chosen by cursor.
3. Rotate the **ENTER** knob to move the cursor.
4. Press the **6/SCAN** key to restart the scanning.

1.8 Setting for Auto Acknowledgement

Individual, position, polling and test calls can be acknowledged automatically or manually.

Press the **5/ACK/SQ** key to switch the acknowledge mode between automatic and manual alternately. The message AUTO ACK or MANUAL ACK appears on the DSC standby screen with each press of the key.

Note: When own ship's communication is high priority, set to MANUAL ACK.

The auto acknowledgement is not sent in the following cases:

- The category of a received message is DISTRESS, URGENCY or SAFETY.
- The communication mode is NBDP-FEC, NBDP-ARQ or DATA.
- Com Freq is NO INFO.
- ECC is NG (No Good).
- The handset is off hook.

1.9 System Characteristics

1.9.1 Equipment priority

Equipment priority order is as below.

1. Control unit sending distress alert
2. Control unit 1 – routine use
3. Control unit 2 – routine use
4. NBDP

1.9.2 Controls become inoperative

Controls become inoperative in the following conditions:

- When the other control unit goes OFF HOOK on RT mode in the two control units system.
- When the other control unit switches to the DSC mode in the two controls system.
- NBDP is scanning or communicating.
- Distress alert or distress relay is transmitted.
- Call other than distress is transmitted (transmission time about 8 sec.) If it becomes necessary to unlock the keyboard before the message is transmitted, press the **CANCEL** key to cancel the call.

1.9.3 Controls become operative

Controls become operative in the following conditions:

- **DISTRESS** button is pressed.
- Control unit having higher priority is operated.

1. OPERATIONAL OVERVIEW

- The other control unit in two controls unit system goes ON HOOK.
- NBDP stops scanning or communicating.

1.9.4 Automatic setting of working frequency

The radiotelephone automatically sets working frequency in the following conditions:

- ABLE ACK is sent in response to individual call.
- Your ship receives ABLE ACK in response to own ship-initiated individual call.
- *Your ship receives ABLE ACK with COM. Frequency automatically changes in response to own ship-initiated individual call.
- Your ship sends geographical area call.
- Your ship sends distress relay.
- Your ship sends distress alert.
- *Your ship receives group call.
- *Your ship receives geographic area call.
- *Your ship receives distress alert.

*: When receiving a call with different frequency from the setting, the following window appears.

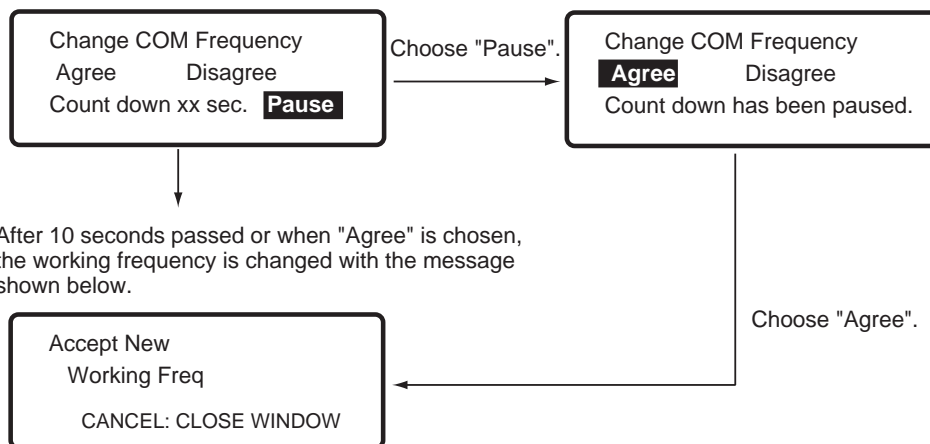

1.10 Intercom

The built-in intercom permits voice communications between two control units.

1. Off hook the handset at the radiotelephone screen.
2. Press the **IntCom** key to show INTERCOM on the display. The called party's control unit rings.
3. When the called party picks up their handset, start communications.
4. Hang up the handset to turn the intercom off. The indication INTERCOM disappears from the screen.

2. SSB RADIOTELEPHONE

You can use the SSB communication in the RT (radiotelephone) mode. Press the **RT/CH** key to show the RT screen.

2.1 Choosing Class of Emission

There are three emission modes, SSB, TLX and AM.

- SSB: Single Sideband
- TLX: Telex (see chapter 7 to 10.)
- AM: AM (You cannot transmit in the AM mode.)

At the radiotelephone screen, choose class of emission as follows:

1. Rotate the **ENTER** knob to highlight the emission mode (default: SSB) and then push the **ENTER** knob. When rotating the **ENTER** knob clockwise, the cursor moves from “CH” to downward.

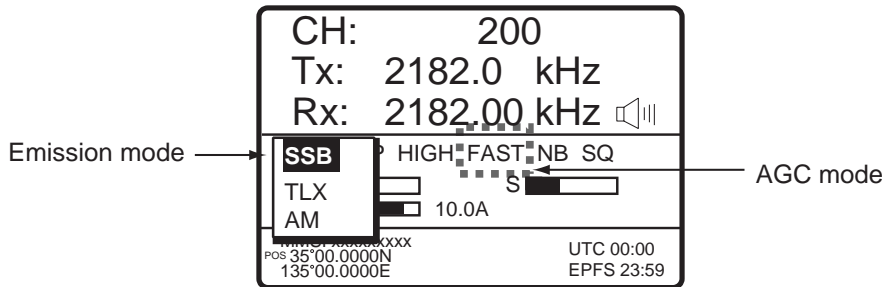

2. Rotate the **ENTER** knob to choose mode desired and then push the **ENTER** knob. AGC is automatically selected according to emission mode.
 - SSB : AGC FAST
 - TLX: AGC OFF
 - AM: AGC SLOW
3. However, you may change it as below.
4. Rotate the **ENTER** knob to choose AGC mode and then push the **ENTER** knob.

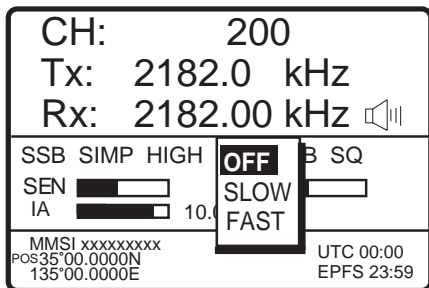

5. Rotate the **ENTER** knob to choose OFF, SLOW or FAST as appropriate and then push the **ENTER** knob.

2.2 Choosing Channel, Frequency

Choose the channel or transmitting frequency to use for the SSB. This setting can be done both when the handset is on and off hook.

Note: To set the SSB radiotelephone to 2182 kHz/J3E, press the **RT/CH** key more than five seconds.

Choosing channel

1. Rotate the **ENTER** knob to choose CH and then push the **ENTER** knob. You can show the channel window by pushing also **1/CH** key.

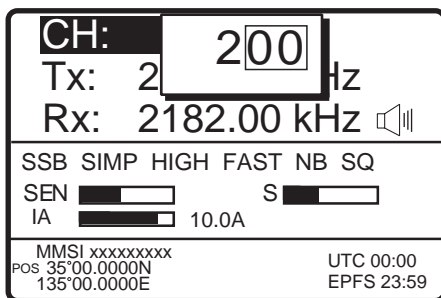

2. Channel can be entered directly with the numeric keys, or by using the **ENTER** knob. See below for details.

Entering band and band channel with the numeric keys: Use the numeric keys to enter band and band channel and then push the **ENTER** knob.

Choosing band and band channel with the ENTER knob:

After showing the window, use the **FILE/CURSOR** key to place the cursor in the band or band channel position, whichever you want to change.



Cursor position for selection of band channel



Cursor position for selection of band

3. Rotate the **ENTER** knob to set band (or channel) desired.

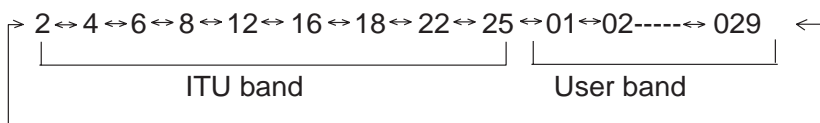

Setting Range

- ITU Band: 2/4/6/8/12/16/18/22/25
- User Band: 001-029 (First zero is necessary)
- ITU Channel: XX01 - XX236 (rendering on band or mode)
- User Channel: XXX01 - XXX99

4. Push the **ENTER** knob. The Tx and Rx frequencies of the channel entered appear.

Choosing frequency

1. Rotate the **ENTER** knob to choose Tx or Rx as appropriate and then push the **ENTER** knob.

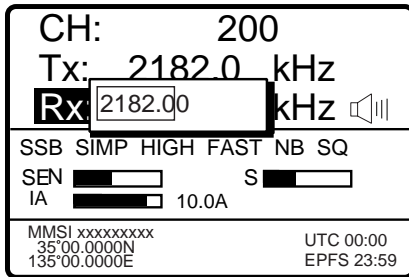

2. Enter frequency by one of the methods below.

Entering frequency with the numeric keys:

Use the numeric keys to enter frequency and then push the **ENTER** knob. For example, to enter 2161 kHz, key in **2, 1, 6, 1, 0**. (Keying in 2-1-6-1 will set 216.1 kHz.) Be sure to include zero for 100 Hz place.

Choosing frequency with the ENTER knob (for RX only):

3. Use the **FILE/CURSOR** key to choose digit to change.
4. Rotate the **ENTER** knob to set digit.
5. Push the **ENTER** knob.

Note: When Tx and Rx frequencies are different, enter Tx and Rx in that order:

Tx: Tx/Rx frequencies

Rx: Rx frequency only

2.3 Transmitting

After selecting class of emission and frequency, you can transmit by pressing the PTT switch. **Tx** is shown on the display.

2.3.1 Transmitting procedure

Maximum transmission power is achieved only when the antenna impedance and transmitter impedance match each other. Because the antenna impedance changes with frequency, antenna impedance matching with the transmitter impedance is done with the antenna coupler. The antenna coupler automatically tunes the transmitter to a wide range of different antenna lengths, from 7 to 18 (FS-1570/2570) or 10 to 18 (FS-5070) meters.

To initiate the automatic tuning, do the following:

1. Press the **PTT** switch on the handset or the **LOG/TUNE** key more than one second on the control unit. Tuning is automatically adjusted at first transmission after frequency is changed. "TUNING" appears when the **LOG/TUNE** key is pressed more than one second; "Tx" pops out when the PTT switch is pressed. Tuning will be completed within 2 to 5 seconds for a newly selected frequency, or less than 0.5 seconds for a once-tuned frequency. When the tuning process is successfully

2. SSB RADIOTELEPHONE

completed, TUNE: OK appears. If tuning fails, TUNE: NG appears.

2. Hold the handset close to your mouth, press the **PTT** switch and speak clearly.

Note: When tuning is initiated in the two control units system, the display of the idle control unit shows "OCCUPIED(ANOTHER CONTROLLER)." In this case, only the DISTRESS button is operative on the idle control unit. Further, if a control unit is in use when the other control is tuned, the display of the activated control unit shows "OCCUPIED" plus the reason why cannot use: ANOTHER CONTROLLER or NBDP to inform you that tuning is not operated.

2.3.2 Reducing transmitter power

To minimize possible interference to other stations, reduce the transmission power. This should be done when using the transceiver in a harbor, near the shore or close to communication partner (other ship).

1. Rotate the **ENTER** knob to choose HIGH, MID, LOW (1) or LOW2 (shown on FS-5070) in the equipment states area and then push the **ENTER** knob.

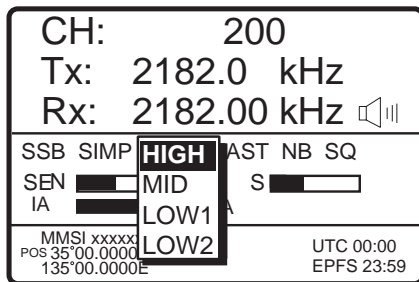

(The above figure shows FS-5070.)

	FS-1570	FS-2570	FS-5070
HIGH	150W _{pep}	250W _{pep}	500W _{pep}
MID	100W _{pep}	125W _{pep}	350W _{pep}
LOW1*	68W _{pep}	90W _{pep}	200W _{pep}
LOW2			110W _{pep}

*: For FS-1570/2570, "LOW"

(Power: ITU401CH)

2. Rotate the **ENTER** knob to choose a power as appropriate and then push the **ENTER** knob.

Note: Power amplifier temperature is monitored, and when its temperature rises above a certain temperature output power is automatically reduced. For FS-5070, when the over current is detected, output power is automatically reduced.

2.3.3 Condition of the transmitting unit

While transmitting, you may display RF (PA output), IA (antenna current), IC (collector current) or VC (collector voltage), at the lower left-hand side of the radiotelephone screen.

1. Rotate the **ENTER** knob to choose RF, IA, IC or VC (whichever is displayed) in the equipment states area, and push the **ENTER** knob.

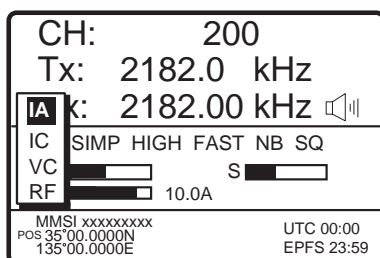

} Equipment states area

2. Rotate the **ENTER** knob to choose option desired and then push the **ENTER** knob.

Checking the transmitting power

During transmission, the IA bar deflects according to the current being fed to the antenna feeder from the antenna coupler. The unit of readout is amperes. The antenna current varies with the effective antenna impedance. The reading differs by the frequency and antenna length. The output power is proportional to the square of an antenna current.

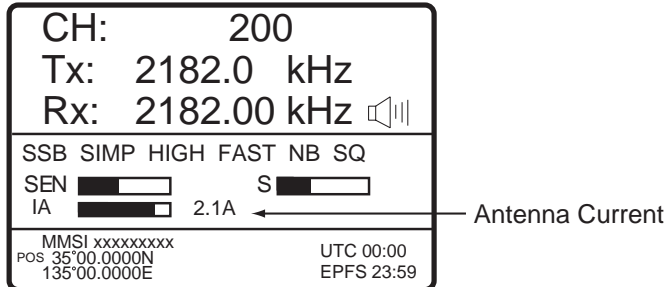

2.4 Receiving

Check if the emission mode and receiving frequency are set properly. If necessary, set them again referring to section 2.1 and 2.2.

2.4.1 RF gain (sensitivity) adjustment

In normal use the sensitivity should be set for maximum. If the audio on the received channel is unclear or interfered with other signals, adjust (usually reduce) sensitivity to improve clarity.

1. Rotate the **ENTER** knob to choose SEN in the equipment states area and then push the **ENTER** knob.

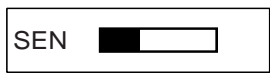

2. Rotate the **ENTER** to adjust and then push the **ENTER** knob.

2.4.2 S-meter

The S-meter shows relative signal strength coming into the receiver front end. Note that the S-meter does not function when the AGC is turned off.

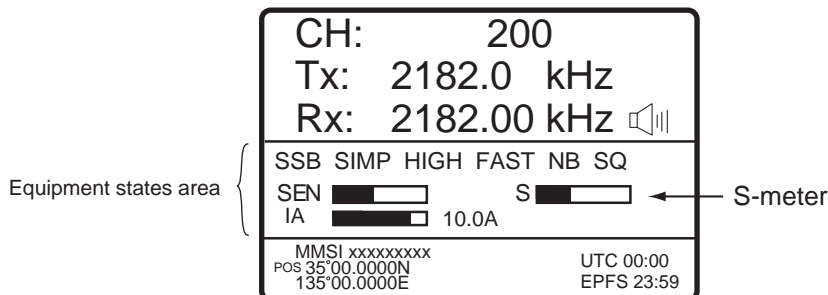

2. SSB RADIOTELEPHONE

2.4.3 Receiving AM broadcasting stations

1. Press the **RT** key to show the radiotelephone screen.
2. Rotate the **ENTER** knob to choose emission mode and then push the **ENTER** knob.

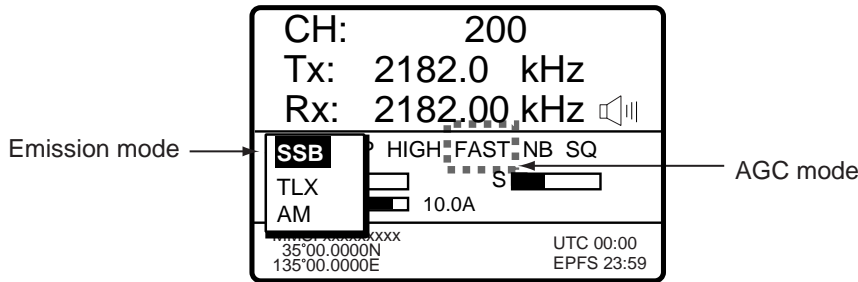

3. Rotate the **ENTER** knob to choose AM and then push the **ENTER** knob.
4. Rotate the **ENTER** knob to choose Rx and then push the **ENTER** knob.

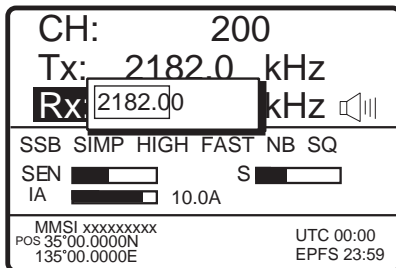

5. Key in RX frequency with the numeric keys and then push the **ENTER** knob.

2.4.4 Squelch function

Squelch on/off

The squelch mutes the audio output in the absence of an incoming signal. Press the **ACK/SQ** key to turn on and off the squelch alternately. When radio noise is too jarring during stand-by condition, it may be muted by activating the squelch. "SQ" in the equipment states area is hatched when the squelch function is active.

Squelch frequency

To adjust the squelch frequency, see section 6.3.

2.4.5 Noise blanker

The noise blanker functions to remove pulse noise. To turn it on or off, see section 6.2.

2.5 When Automatic Tuning Fails

The antenna coupler automatically tunes a wire or whip antenna transceiver. When all frequencies cannot be tuned, TUNE: OK will not appear on the display. In this case, you can tune 2182 kHz by manually operating the coupler as shown below.



1. Turn off the control unit. Remove the cover of the antenna coupler.
2. Set the MANUAL-AUTO switch to the MANUAL position.

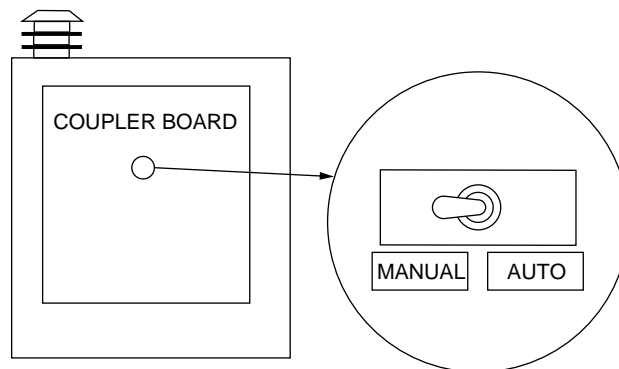

3. Replace the cover.
4. Turn on the control unit.
5. Communicate using 2182 kHz.

2.6 User Channels

The USER CH menu provides for registration of user TX and RX channels, where permitted by the Authorities. The user channel in the System setup menu must be enabled in order to register user channels. For further details, contact your dealer. See section 6.4 to register.

NOTICE

FURUNO will assume no responsibility for the disturbance caused by the unlawful or improper setting of user channels.

3. DSC OVERVIEW

3.1 What is DSC?

DSC is an acronym meaning Digital Selective Calling. It is a digital distress and general calling system in the MF and HF bands used by ships for transmitting distress alerts and general calls and by coast stations for transmitting the associated acknowledgements. For DSC distress and safety calling in the MF and HF bands, the frequencies are 2187.5, 4207.5, 6312.0, 8414.5, 12577.0, and 16804.5 kHz.

The DSC station sends and receives DSC general and distress calls via the radiotelephone.

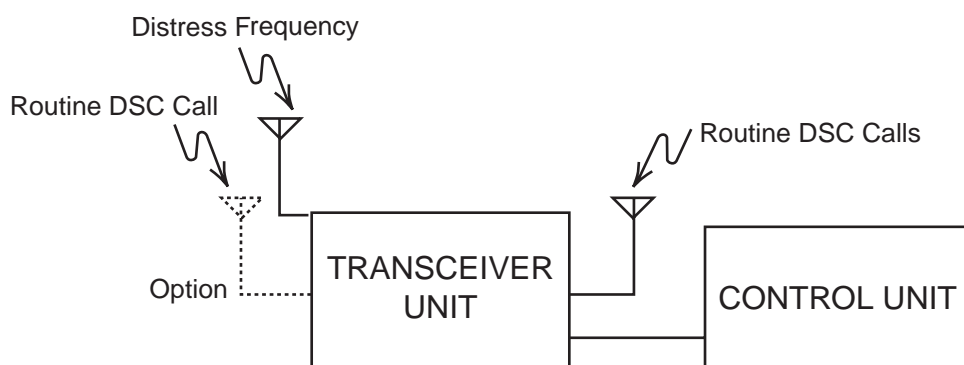

3.2 DSC Message

DSC calls are roughly divided in two groups: distress, urgency and safety messages, and routine messages. Below are the types of DSC messages.

Call	Description
Distress Alerts	Your ship sends distress message
Distress relay area	Your ship relays distress call to all ships in a specific geographical area
Distress relay coast	Your ship relays distress call to a coast station
Medical Transport	Inform areas that your ship is carrying medical supplies*
Neutral Craft	Inform areas that your ship is not a participant in armed conflict*
Individual	Call to a specific address
PSTN message	Call over Public Switched Telephone Network (PSTN)
Test message	Send test signal to a station to test your station's functionality
Group message	Call to a specific group
Area message	Call to all ships in a specific geographical area
Position	Your ship requests position of other ships
Polling message	Confirm if own ship is within communicating range with other ships. (Receive and answer only)

*Special Message: When sending these messages, set the acknowledgement. See section 6.15.

3. DSC OVERVIEW

Contents of a DSC call

Calling category

Call category	Call
DISTRESS	Distress Alerts, Distress relay area, Distress relay coast
GENERAL	Individual, PSTN message, Test message, Group message, Area message, Position, Medical Transport, Nautical Craft, Polling message

Station ID

Own ship ID and sending station ID. Coast station ID begins with 00; Group ID begins with 0.

Priority

- Distress:** Grave and imminent danger and request immediate assistance.
- Urgency:** A calling station has a very urgent call to transmit concerning safety of ship, aircraft or other vehicle or safety of person.
- Safety:** A station is about to transmit a call containing an important navigational or meteorological warning.
- Routine:** General calling

Communication type

- Telephone:** Telephone (J3E) by SSB radiotelephone
- NBDP-ARQ:** Telex (J2B) mode ARQ via NBDP Terminal Unit
- NBDP-FEC:** Telex (J2B) mode FEC via NBDP Terminal Unit
- DATA:** Data communication by SSB (Routine individual only)

Communication frequency

Working frequency used to call by telephone, NBDP or DATA. The sending station may have the receiving frequency (ship or coast station) assign the frequency to use.

Position

Position can be automatically or manually sent.

DSC frequency

DSC frequency to use. If the call priority is SAFETY, URGENCY and DISTRESS, choose a DSC distress frequency.

End code

The end of a DSC call is denoted by RQ (Acknowledgement required), BQ (Acknowledgement) or EOS (no acknowledgement required).

3.3 Audio Alarms

When you receive a distress alert or routine call addressed to your ship, the audio and visual alarms are released. For the distress or urgency call, the audio alarm sounds until the **CANCEL** key is pressed, and sounds for one minute and then automatically goes off in case of other calls. The tone of the alarm changes with the call received. By becoming accustomed to the tone, you can know which type of call you or other party have received.

Alarm	Frequency (interval)
Safety call received	150 Hz (1000 ms) and 100 Hz (500 ms)
Routine call received	150 Hz (1000 ms) and 100 Hz (500 ms)
While DISTRESS button is pressed for four s	2000 Hz and 0 Hz (500 ms)
Distress alert sent	2200 Hz, continuous (2 seconds)
Own ship position not updated	2000 Hz (250 ms) and 0 Hz (500 ms)
Distress alert call received	2200 Hz and 1300 Hz (250 ms)
Distress relay call received	2200 Hz and 1300 Hz (250 ms)
Distress relay ack call received	2200 Hz and 1300 Hz (250 ms)
Distress ack call received	2200 Hz (500 ms) and 1300 Hz (500 ms)
Urgency call received	2200 Hz and 0 Hz (250 ms)
Urgency ack call received	2200 Hz and 0 Hz (500 ms)

3.4 Interpreting Call Displays

This paragraph provides the information necessary for interpreting receive and send call displays.

3.4.1 Receive calls

Below are sample distress and individual receive calls. The content of other types of receive calls is similar to that of the individual call.

Distress receive call

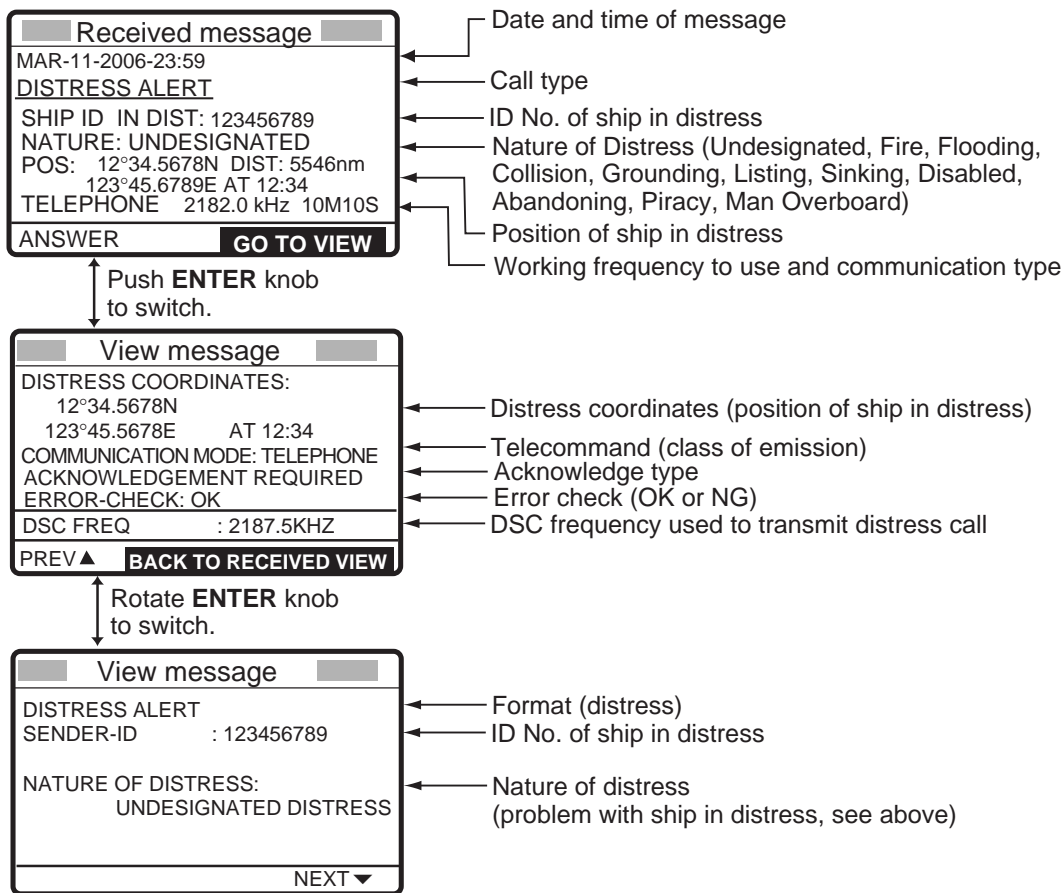

Individual receive call

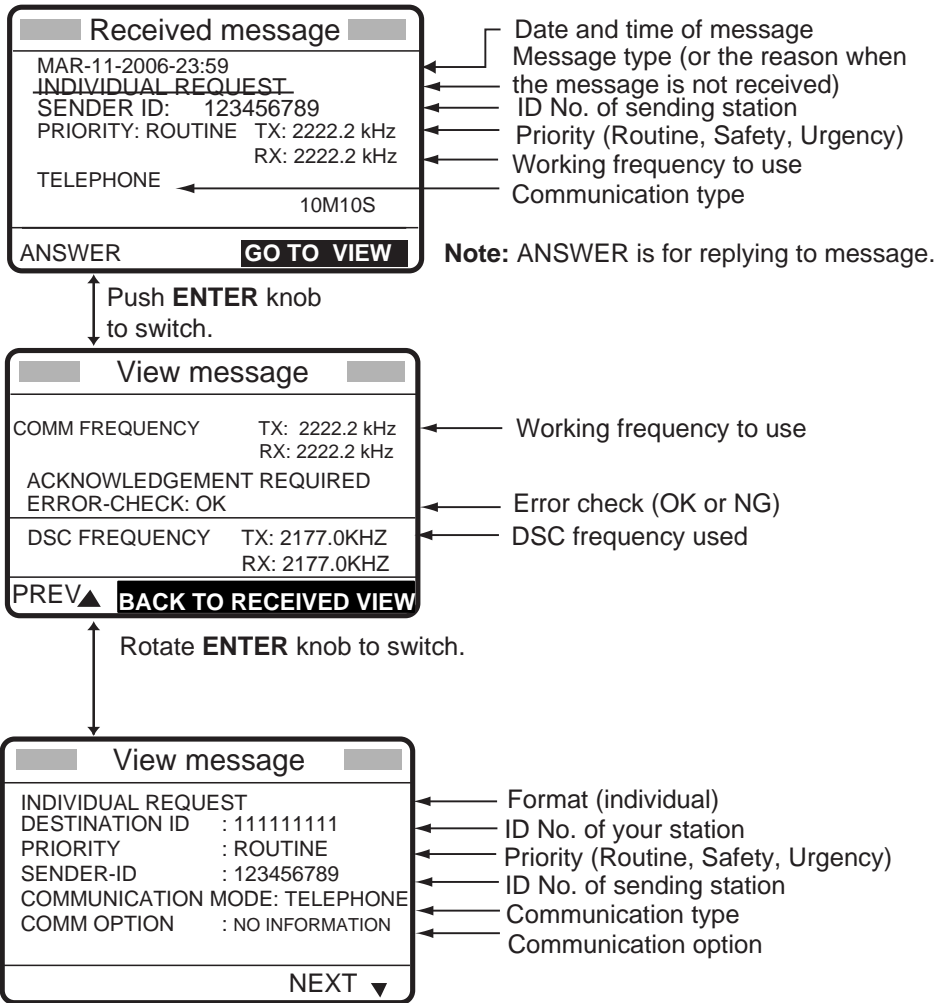

3.4.2 Send calls

Below are sample distress and individual send calls. The content of other types of send calls is similar to that of the individual call.

Distress send call

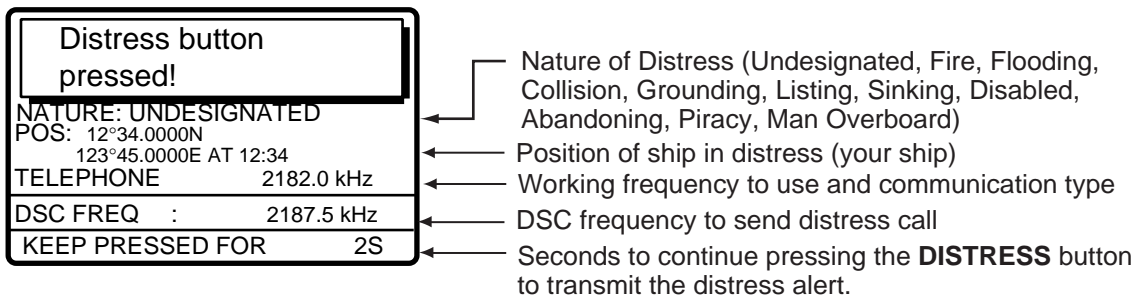

3. DSC OVERVIEW

Individual send call

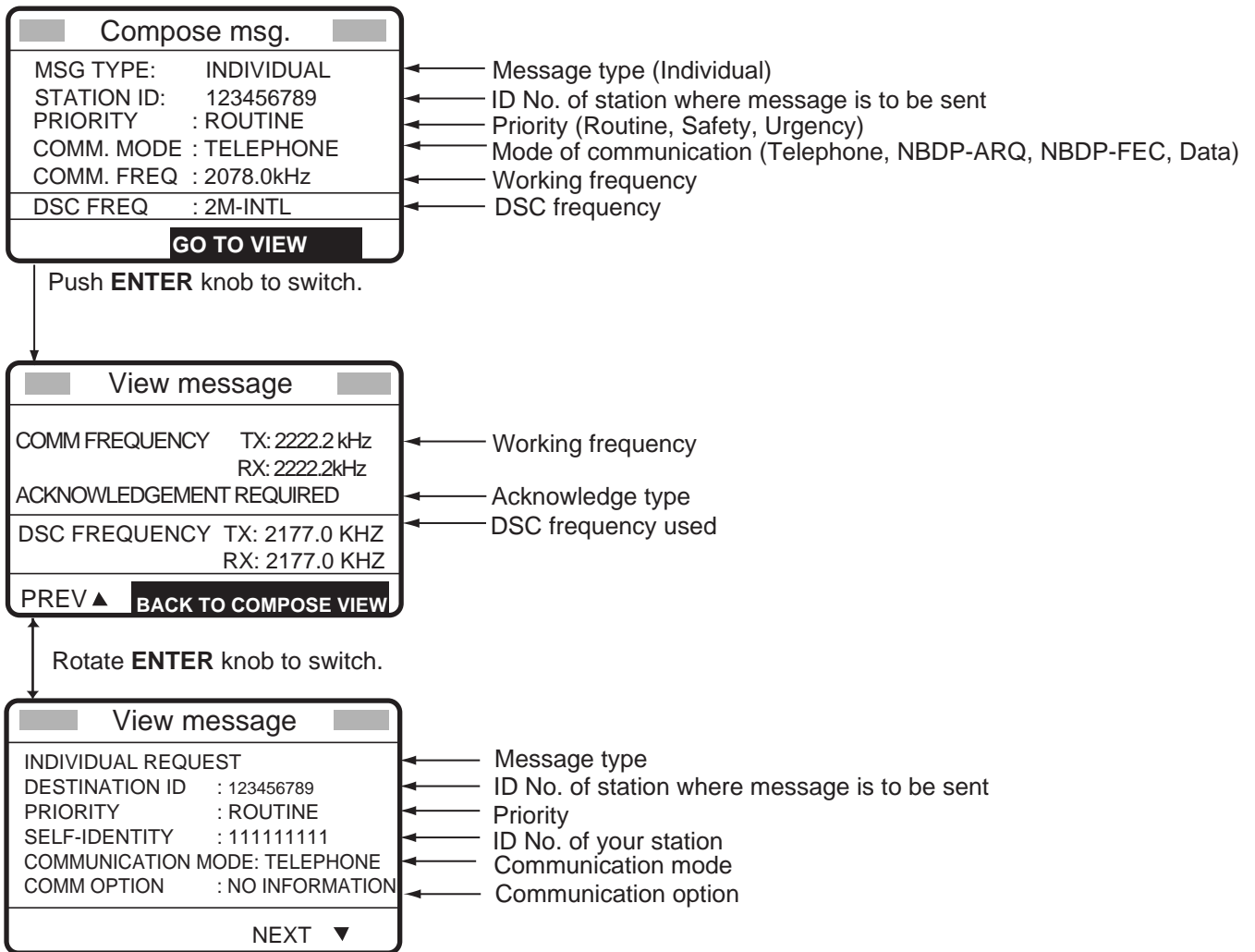

4. DISTRESS OPERATIONS

Distress operation overview

1. Press the **DISTRESS** button.
2. Wait for the distress alert acknowledgement.
3. Communicate with the coast station.

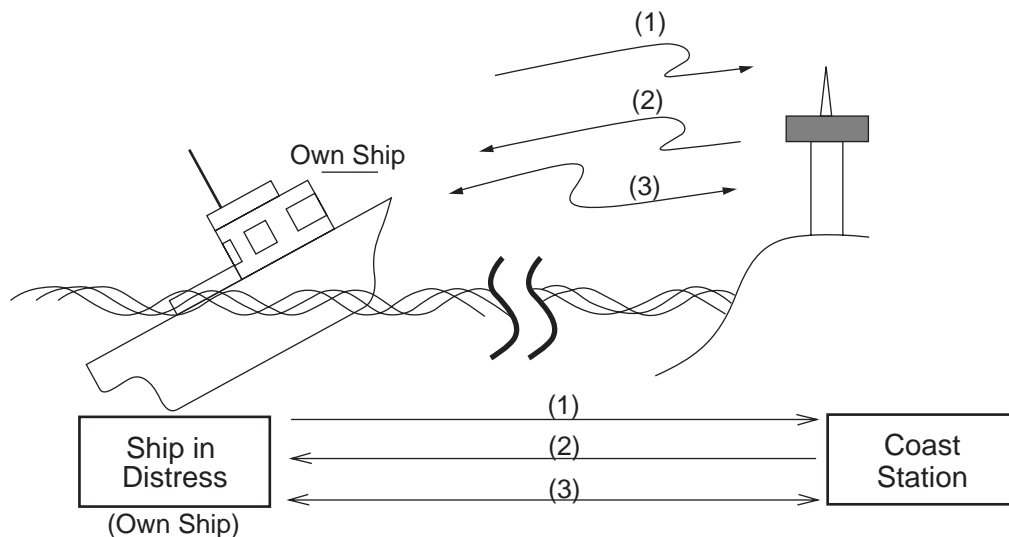

(1) Ship in distress sends Distress Alert.

(2) Coast station sends distress acknowledgement (DIST ACK).

(3) Voice or telex communications between ship in distress and coast station

For details, see below.

4.1 Sending Distress Alert

GMDSS ships carry a DSC terminal with which to transmit the distress alert in the event of a life-endangering situation. A coast station receives the distress alert and sends the distress alert acknowledgement call to the ship in distress. Then, voice or telex communications between the ship in distress and coast station begins. Transmission of the distress alert and receiving of the distress alert acknowledgement are completely automatic – simply press the **DISTRESS** button to initiate the sequence. Note that the distress can also be transmitted from the Distress Alert Unit IC-302.

There are four types of sending distress alert; MULTI, AUTO, SELECT and 2-16MHz. MULTI is used normally. When changing to other method, see step 15 on paragraph 4.1.2.

4. DISTRESS OPERATIONS

4.1.1 Sending distress alert by **DISTRESS** button, nature of distress not specified

1. Open the **DISTRESS** button cover and press and hold down the **DISTRESS** button more than four seconds. The button flashes in red and the buzzer sounds rapidly. The display shows the contents of the distress alert call: your ship's nature of distress, position, time and the DSC frequency over which the alert has been transmitted.

The number of seconds to continue pressing the **DISTRESS** button appear at the bottom of the display. The buzzer sounds continuously and the lamp in the button lights when the button has been pressed four seconds. You can release the button at that time.

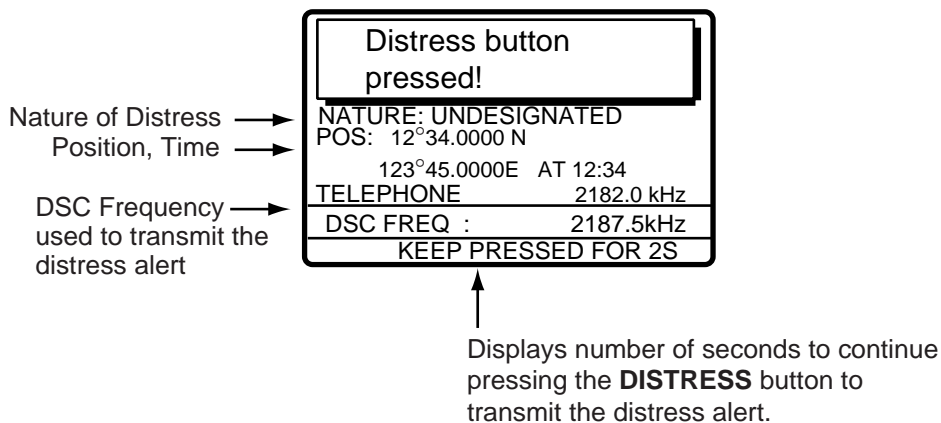

The display changes as below. It takes about 40 to 60 seconds to transmit the distress alert, and the number of seconds until transmission is completed is shown at the bottom of the display. At this time the output power of the radiotelephone is automatically set to maximum.

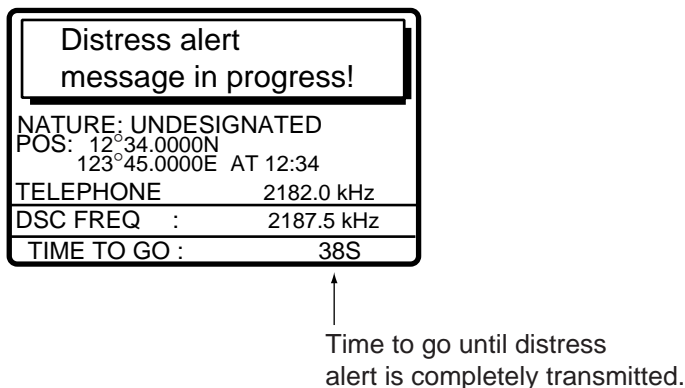

After the distress alert has been sent, the display changes as below and the audio alarm is stopped. Wait to receive the distress acknowledge call from a coast station, which usually takes 1 to 2 min 45 seconds. (The **DISTRESS** button remains lit until the equipment receives the distress acknowledge call from a coast station.) When waiting the distress acknowledge, the timer counts down the number of minutes before next retransmission, from 3.5 to 4.5 minutes, randomly set.

At this time, the equipment cannot receive any calls except the distress alert acknowledge call. The distress alert you sent is recorded in the TX log.

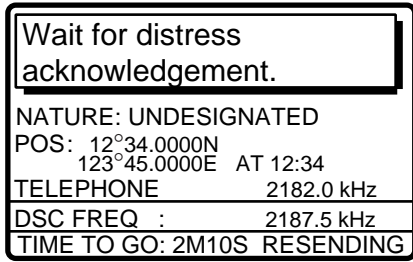

When the distress acknowledge call is received, the audio alarm sounds and the display changes as below.

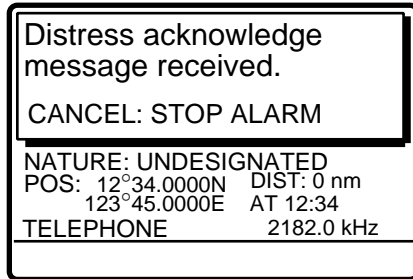

Note: If you do not receive the distress alert acknowledge call, the equipment automatically re-transmits the distress alert and then awaits the distress alert acknowledge call. This is repeated until the distress alert is acknowledged.

2. Silence the alarm with the **CANCEL** key when the distress acknowledge call is received. The contents of the distress acknowledge call appear.

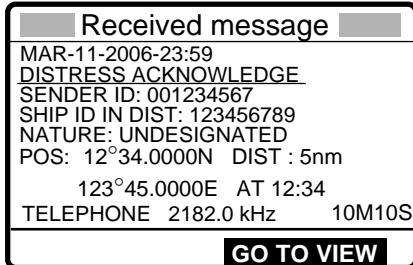

← Elapsed time after receiving (Max. "60M00S" For over 60 minutes, nothing appears.)

3. Communicate with the coast station via radiotelephone, following the instructions below. The radiotelephone automatically sets working frequency and class of emission, as specified in the distress acknowledge call.
 - a) Say MAYDAY three times.
 - b) Say "This is ... " name of your vessel and call sign three times.
 - c) Give nature of distress and assistance needed.
 - d) Give description of your vessel (type, color, number of persons onboard, etc.).

4. DISTRESS OPERATIONS

4.1.2 Sending distress alert by DISTRESS button, nature of distress specified

If you have the time to designate the nature of distress, send the distress alert as follows:

1. Open the DISTRESS button cover and press the **DISTRESS** button momentarily to show the following display.

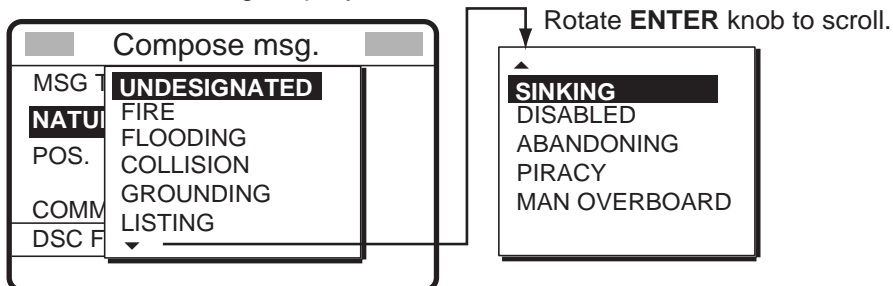

2. Rotate the **ENTER** knob to choose nature of distress and then push the **ENTER** knob.
3. Push the **ENTER** knob to open the POS. menu. This is where you enter your position, automatically or manually. The INPUT TYPE option, that is, the source of position data, is selected to EPFS, MANUAL or NO INFO. For EPFS, if the position is correct, push the **ENTER** knob twice and go to step 12. For manual input, or you do not know your position, go to step 4.

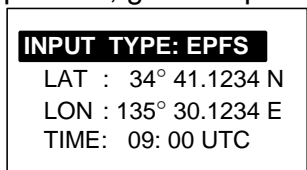

Note: If the message "No Position Data" appears when you change INPUT TYPE from MANUAL to EPFS, confirm that the navigation device is functioning and then choose EPFS again.

4. Push the **ENTER** knob to open the INPUT TYPE menu.

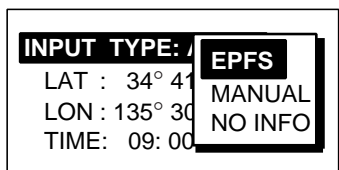

5. Rotate the **ENTER** knob to choose MANUAL and then push the **ENTER** knob to go to step 6. If you cannot confirm your position, choose NO INFO, push the **ENTER** knob twice and then go to step 10.
6. Push the **ENTER** knob to open the latitude input window.
7. Use the numeric keys to enter latitude (in eight digits). (If necessary, switch coordinates: **1** key to switch to North; **2** key to switch to South.) Push the **ENTER** knob.

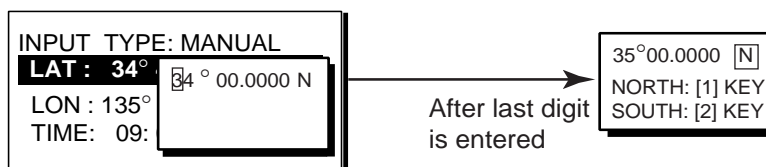

8. Push the **ENTER** knob to open the longitude input window.
9. Use the numeric keys to enter longitude (in nine digits). (If necessary, switch coordinates: **1** key to switch to East; **2** key to switch to West.) Push the **ENTER** knob.

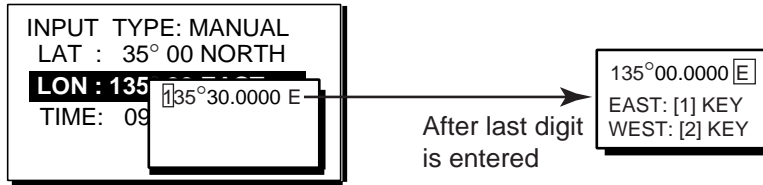

10. Push the **ENTER** knob to open the time input window.

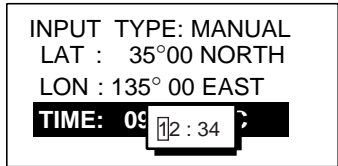

11. Key in UTC time with the numeric keys and then push the **ENTER** knob.
Note: If you cannot confirm time, enter 88:88 to input NO INFO as the time.
12. The COMPOSE MESSAGE screen is redisplayed. Push the **ENTER** knob to open the COMM MODE menu.

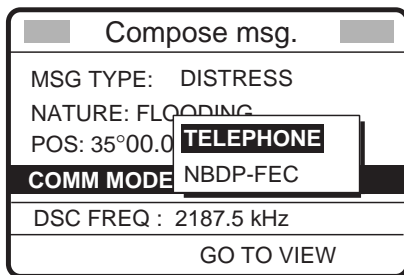

13. Rotate the **ENTER** knob to choose TELEPHONE or NBDP-FEC as appropriate and then push the **ENTER** knob. (Telephone is the usual mode, however NBDP may also be used.)
14. Push the **ENTER** knob to open the DSC FREQ menu.

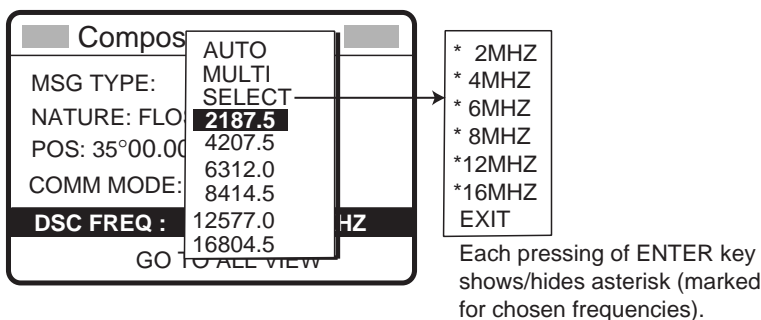

15. Rotate the **ENTER** knob to choose a DSC frequency mode, and push the **ENTER** knob.
MULTI: Transmits the distress alert on 2MHz, 4 MHz, 6 MHz, 8MHz, 12 MHz and 16 MHz in that order in a transmission, then waits for acknowledgement.
AUTO: Transmits the distress alert on 2 MHz at first time (40 to 60 seconds). If the distress alert is not acknowledged, the following sequence occurs:
 2nd: 8 MHz, 3rd: 16 MHz, 4th: 4 MHz, 5th: 12 MHz and 6th: 6 MHz
SELECT: You can transmit on the distress frequencies of your choice. The minimum number is three and 2 MHz and 8 MHz are mandatory; they cannot be deselected.
2187.5 to 16804.5: Transmits the distress alert on the frequency chosen five times.

4. DISTRESS OPERATIONS

The display changes as below (example).

Compose msg.	
MSG TYPE	: DISTRESS
NATURE	: FLOODING
POS: 35°00.0000N	
135°00.0000E	AT 12:34
COMM MODE	: TELEPHONE
DSC FREQ	: 2187.5 kHz
GO TO VIEW	

16. Press the **DISTRESS** button more than four seconds to send the distress alert.

Distress alert message in progress!	
NATURE: FLOODING	
POS: 35°00.0000N	
135°00.0000E	AT 12:34
TELEPHONE	2182.0 kHz
DSC FREQ	: 2187.5 kHz
TIME TO GO	: 38S

17. When the distress acknowledge call is received, use the telephone or telex to communicate.

For telephone, follow step 3 on page 4-3. For NBDP, follow the procedure below.

Communicating by NBDP Terminal Unit

The message "STATION ENTRY COMPLETED FROM DSC. Press any key to escape." Appears on the NBDP's display.

1. Press any key on the NBDP Terminal Unit to erase the message.
2. Press the function key **F3** on the keyboard of the NBDP Terminal Unit to show the Operate menu.
3. Choose "Call Station" and then press the **Enter** key.

Call Station	
Station List	Station Set up
DSC	Station : DSC
ABC-6M	ID Code :
ABC-12M	Mode : ARQ <u>FEC</u>
ABC-8M	Tx Freq : 2174.50
FURUNO	Rx Freq : 2174.50

4. "DSC" is selected; press the **Enter** key to connect the communications line. "Connect" appears in reverse video.
5. Type and transmit your message, giving the following information:
 - Ship's name and call sign
 - Nature of distress and assistance needed
 - Description of your vessel
6. Press the function key **F10** (BREAK) to disconnect the line.

For NBDP details, see Chapters 7 through 10.

4.2 Receiving a Distress Alert

When you receive a distress alert from a ship in distress, the audio alarm sounds and the message “Distress alert message received.” Appears on the display. Press the **CANCEL** key to silence the audio alarm. Wait for the distress acknowledge call from a coast station. If you do not receive the distress acknowledge call from a coast station, which usually takes about five minutes from the time of reception of a distress alert, follow the appropriate flow chart in this section to determine your course of action.

Note 1: An asterisk (*) appearing in a distress alert message indicates error at asterisk location.

Note 2: If the DISTRESS/URGENT RECEIVING UNIT IC-303 is connected, the aural alarm sounds and the IC-303’s alarm lamp lights in red when a distress alert is received. To silence the aural alarm, press the **ALARM RESET** key.

4.2.1 Distress alert received on MF band

Do the following:

- Continue watching on 2182 kHz. Wait for coast station to acknowledge the distress call. Watch until “SEELONCE FINI” is announced.
- If multiple DSC distress alerts are received from the same ship in distress and it is beyond a doubt in your vicinity, a DSC acknowledgement may, after consultation with an RCC or Coast Station, be sent to terminate the call by DSC.

4. DISTRESS OPERATIONS

Action for ship receiving distress alert on MF band

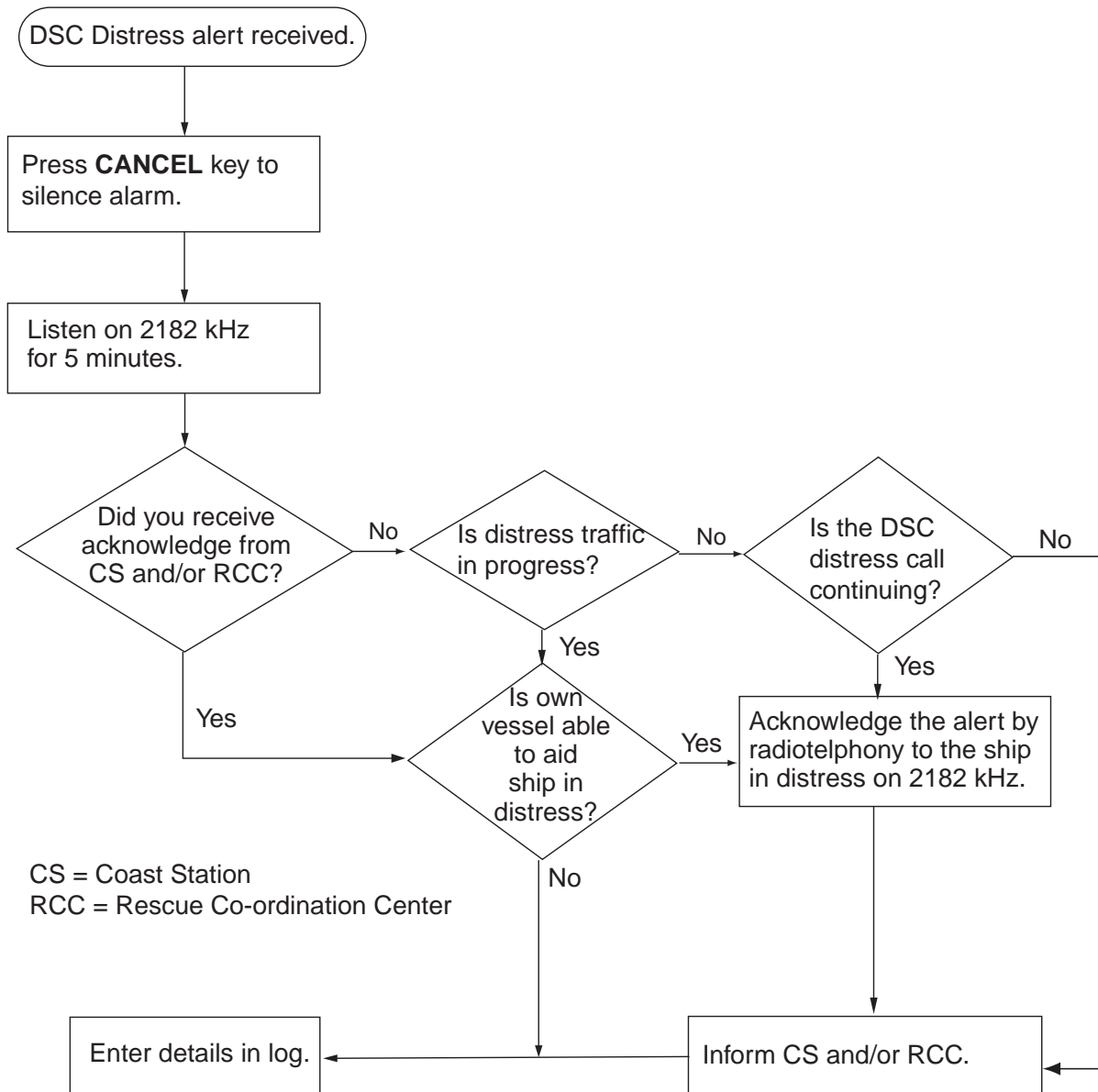

Sending the distress acknowledge call to ship in distress (on MF band)

Note: You cannot send the distress acknowledge call for five minutes because of receiving the distress acknowledgement from the coast station.

Transmit the distress acknowledge call to the ship in distress only when you do not receive it from a coast station and **you are able to aid the ship in distress**. First, transmit the distress acknowledge to the ship in distress by telephone. To terminate transmission of the distress alert, send acknowledge call as follows.

The audio alarm sounds and the display shows the message “Distress alert message received.” When your ship receives a distress alert.

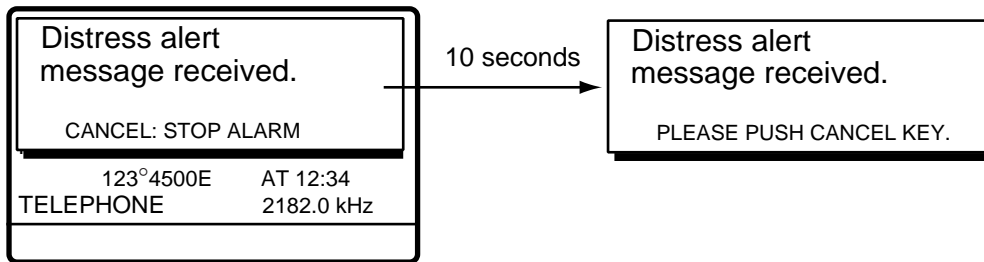

1. Press the **CANCEL** key to silence the audio alarm and the display changes as below.

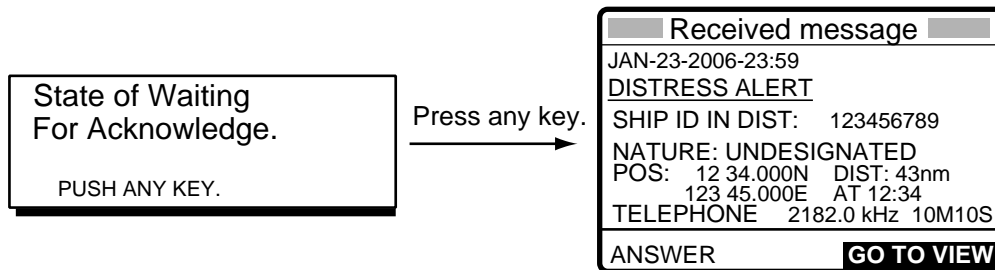

2. **If you do not receive the distress acknowledge call from a coast station and you have received the distress alert more than twice**, contact the ship in distress over radiotelephone.
3. If the distress alert continues, terminate the alert by rotating the **ENTER** knob to choose ANSWER, push the **ENTER** knob and then go to step 4 to send the distress acknowledge call to the ship in distress.
4. Push the **ENTER** knob to open the MSG TYPE menu.

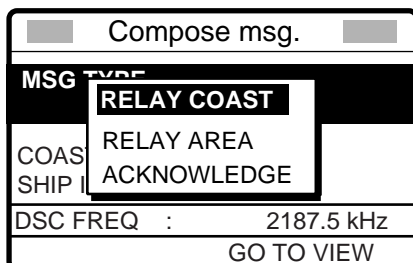

4. DISTRESS OPERATIONS

5. Rotate the **ENTER** knob to choose **ACKNOWLEDGE** and then push the **ENTER** knob. The following display appears.

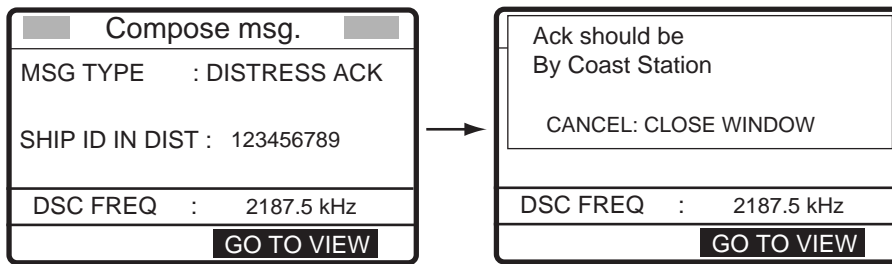

6. Press the **CALL** key for three seconds. The message "Priority distress transmit sure?" appears. Continue to press the key until the message "Distress acknowledge message in progress." Appears, to transmit the distress acknowledge call to the ship in distress.

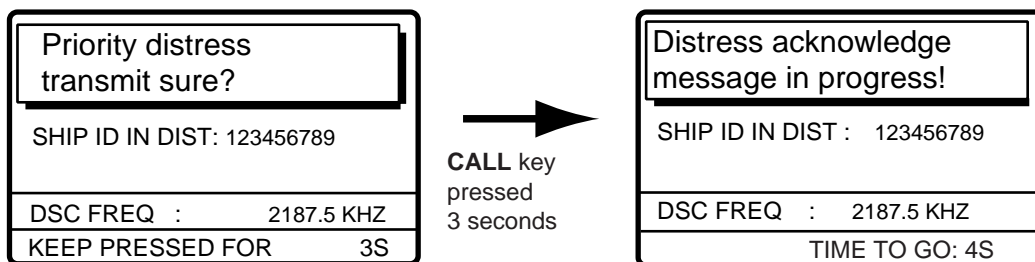

4.2.2 Distress alert received on HF band

If you receive a distress alert on the HF band, the ALARM lamp lights and the audio alarm sounds. Press the **CANCEL** key to silence the audio alarm. Wait for the distress acknowledge from a coast station. If you do not receive the distress acknowledge within five minutes, follow the instructions below to determine your course of action.

- Watch on the distress frequency.
- Relay the distress alert in the following cases:
 - You have not received a distress acknowledge call from a coast station within five minutes after receiving a distress call.
 - You have not received a distress relay from other ship.
 - You cannot receive distress communications from other ship over radiotelephone.
 - If it is clear the ship or persons in distress are not in the vicinity and/or other crafts are better placed to assist, superfluous communications which could interfere with search and rescue activities should be avoided. Details should be recorded in the appropriate log book.
 - The ship relaying the distress alert should establish communications with the station controlling the distress as directed and render such assistance as required and appropriate.

When receiving a DSC message, the following message may appear.

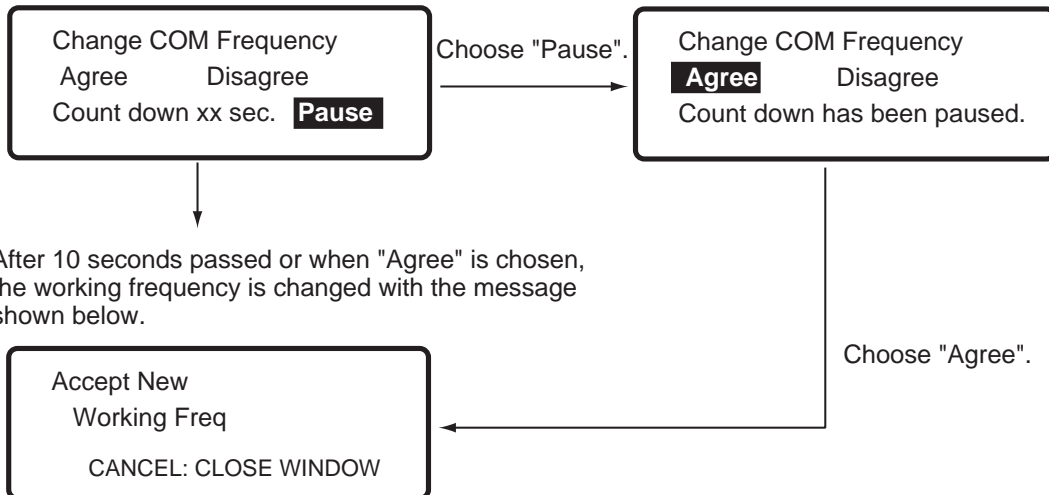

Action for ships receiving distress alert on HF band

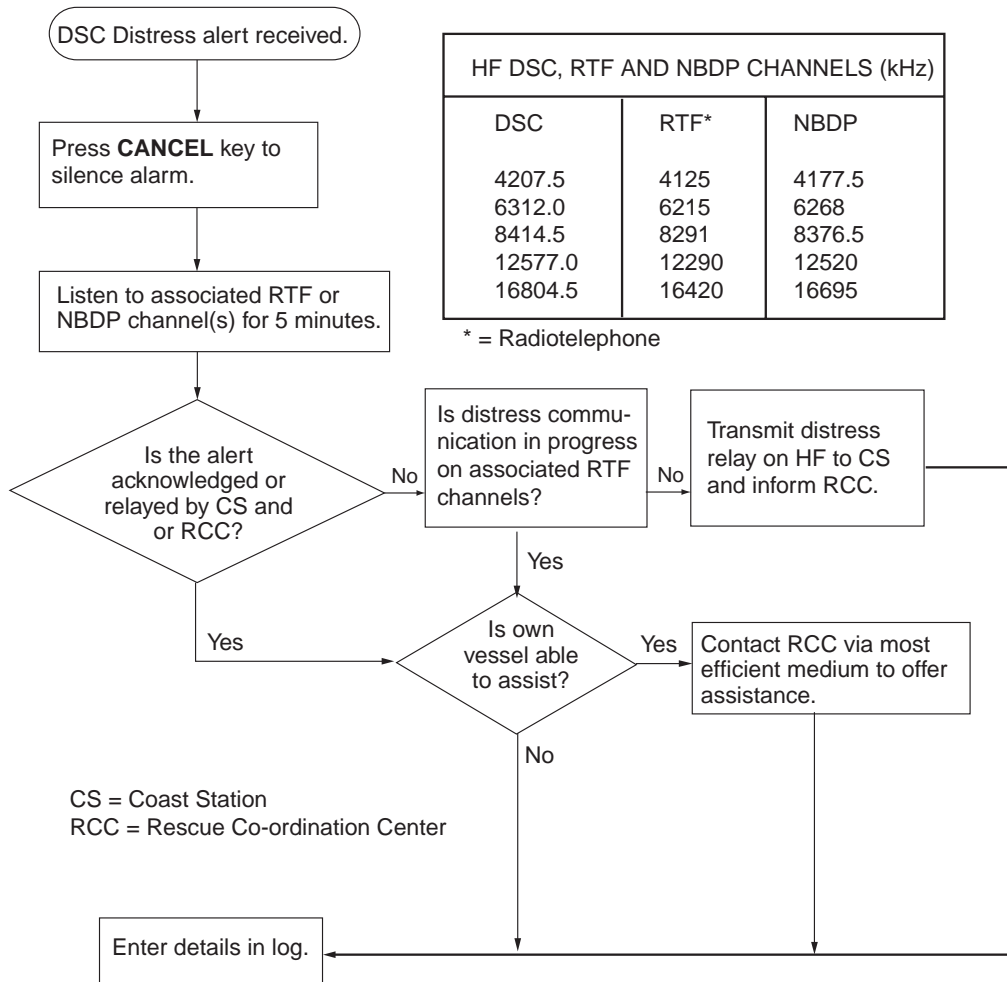

4. DISTRESS OPERATIONS

Sending the distress relay to coast station (on HF band)

The audio alarm sounds and the display changes as below when a distress call is received.

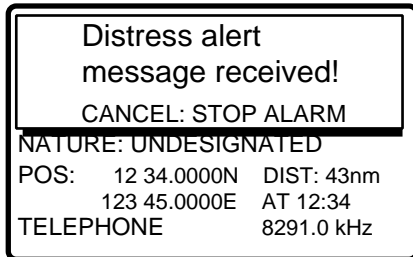

1. Press the **CANCEL** key to silence the audio alarm, and the display changes as below.

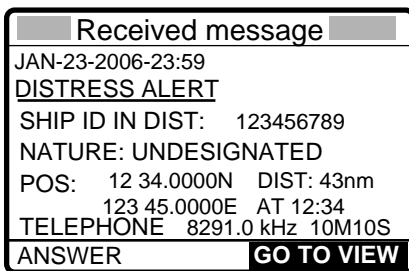

2. Rotate the **ENTER** knob to choose ANSWER and then push the **ENTER** knob.
3. Push the **ENTER** knob to open the MSG TYPE menu.

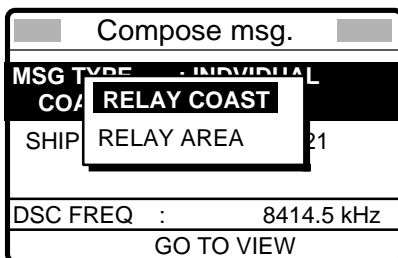

4. If you know the ID of the nearest coast station, choose RELAY COAST and then push the **ENTER** knob.
5. Push **ENTER** knob and key in ID of coast station where to send the distress relay and then push the **ENTER** knob.

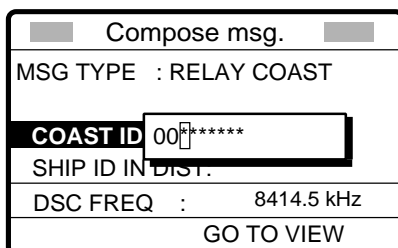

6. Push the **ENTER** knob to open the DSC FREQ. Menu.

Compose msg.	
MSG TYPE:	2187.5
COAST ST	4207.5
COAST ID:	6312.0
SHIP ID IN DI	8414.5
	12577.0
DSC FREQ	16804.5 KHZ
GO TO VIEW	

7. Choose appropriate frequency and then push the **ENTER** knob. You should first choose 8414.5 kHz.
8. Press the **CALL** key, and the display changes as shown below.

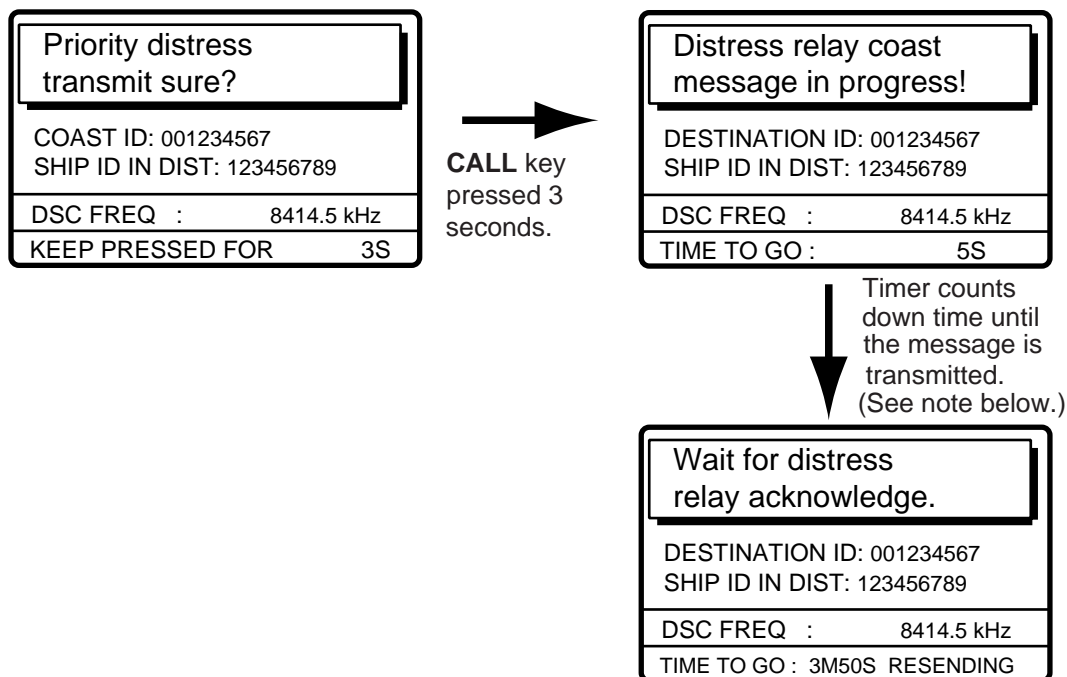

Note: If a coast station acknowledges the call before the timer counts down to zero, press the **CANCEL** key to cancel the distress relay call.

After the call is transmitted, the message “Wait for distress relay acknowledge.” Appears. After you have received the distress acknowledgement from the coast station, communicate with the coast station by telephone, over the frequency specified. If you do not receive the distress acknowledgement from a coast station after the timer counts down to zero, choose RESEND and press the **ENTER** knob to transmit the distress relay again, over a different frequency.

4.3 Sending Distress Relay on Behalf of a Ship in Distress

4.3.1 Sending distress relay to coast station

You may send the distress relay to a coast station on behalf of a ship in distress in the following cases:

You are near the ship in distress and the ship in distress cannot transmit the distress alert.

When the master or person responsible for your ship considers that further assistance is necessary.

Note: In the above cases, never use the **DISTRESS** button.

1. Press the **DSC** key.

Select Message	
GENERAL	DISTRESS
INDIVIDUAL	RELAY AREA
PSTN MESSAGE	RELAY COAST
TEST MESSAGE	DISTRESS
GROUP MESSAGE	
AREA MESSAGE	
POSITION	SPECIAL
MMSI 123456789	
POS 12°34.5678N	UTC 01:53
123°45.6789E	EPFS 01:54

2. Rotate the **ENTER** knob to choose RELAY COAST and then push the **ENTER** knob.
3. Push the **ENTER** knob to open the COAST ID window.

MANUAL
SELECT

4. Rotate the **ENTER** knob to choose MANUAL or SELECT.
When you choose SELECT, a list of file names and ID numbers stored at MESSAGE menu appears (For details, see Chapter 6.) In this case you can choose a file name with ID number desired, and then push the **ENTER** knob and then go to step 6. When choosing MANUAL, go to step 5.

Compose msg.	
MSG TYPE: RELAY COAST	
COAST ID	
SHIP ID IN D	00*****
NATURE: UN	
POS: NO INFORMATION	
COMM MODE	: TELEPHONE
DSC FREQ.	: 8414.5 kHz
GO TO VIEW	

5. Key in COAST ID with the numeric keys and then push the **ENTER** knob.

- Push the **ENTER** knob to open the SHIP ID IN DIST window.

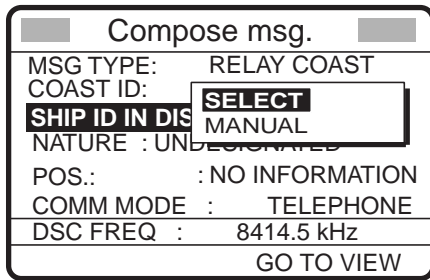

- Choose **MANUAL** or **SELECT**, and then push the **ENTER** knob. When you choose **SELECT**, a list of file names and ID numbers stored at MESSAGE menu appears. Go to step 9. When choosing **MANUAL**, you can choose a file name with ID number desired, and go to step 8.

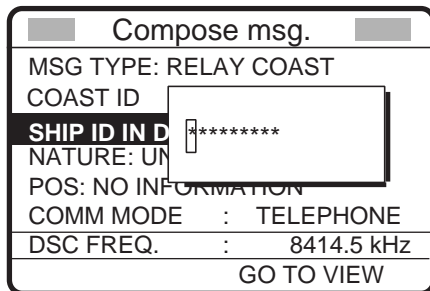

- Key in ship's ID in distress with the numeric keys and then push the **ENTER** knob. If you do not know ID, press the **CANCEL** key.
- Push the **ENTER** knob to open the NATURE menu.

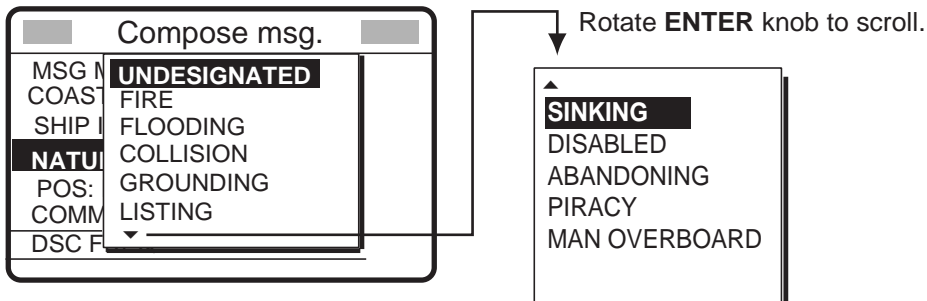

- Rotate the **ENTER** knob to choose nature of distress and then push the **ENTER** knob. If you do not know the nature of distress, choose UNDESIGNATED.
- Push the **ENTER** knob to open the POS. menu.

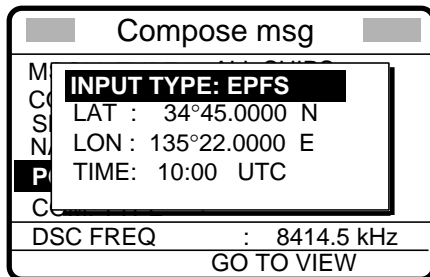

4. DISTRESS OPERATIONS

12. Enter position of ship in distress, following 1), 2) or 3) below.

- 1) **For automatic input**, push the **ENTER** knob and choose EPFS. Then push **ENTER** knob and go to step 13.
- 2) **For manual input**, push the **ENTER** knob to open the INPUT TYPE menu, rotate the **ENTER** knob to choose MANUAL and then push the **ENTER** knob. Enter latitude and longitude of ship in distress and time as follows:
 - a) Push the **ENTER** knob. Enter latitude and then push the **ENTER** knob.
 - b) Push the **ENTER** knob. Enter longitude and then push the **ENTER** knob.
 - c) Push the **ENTER** knob. Enter UTC time and then push the **ENTER** knob. Go to step 13.

Note: If you cannot confirm time, enter 88:88 to input NO INFO as the time.

- 3) **If you cannot confirm position of ship in distress**, push the **ENTER** knob to open the INPUT TYPE menu, rotate the **ENTER** knob to choose NO INFO and then push the **ENTER** knob twice. Go to step 13.

13. Push the **ENTER** knob to open the COM. MODE menu.

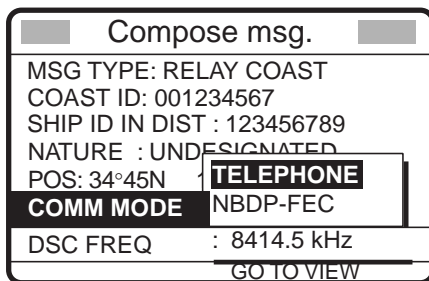

14. Rotate the **ENTER** knob to choose TELEPHONE and then push the **ENTER** knob. (NBDP-FEC may also be used.)

15. Push the **ENTER** knob to open the DSC FREQ menu.

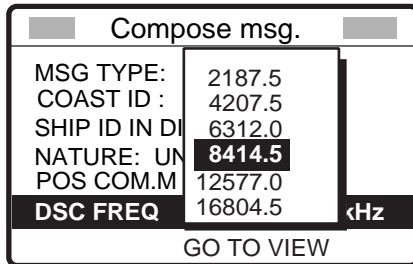

16. Rotate the **ENTER** knob to choose appropriate DSC (NBDP) frequency and then push the **ENTER** knob. The display now looks something like the one below in case of radiotelephone.



17. Press the **CALL** key for three seconds, and the message “Priority distress transmit sure?” appears. Continue pressing the key until the display shows “Distress relay coast message in progress!” to send the distress relay call.

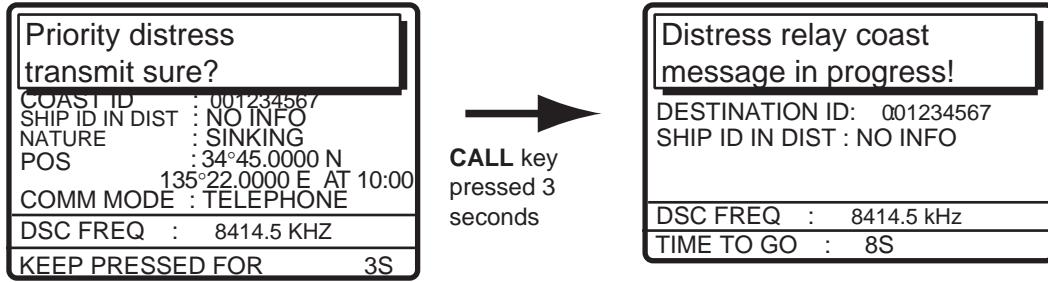

The equipment then waits for acknowledgement of the distress relay, displaying the message shown below. If the distress relay is not acknowledged within five minutes, the message “No response! Try calling again?” appears. If this occurs, send the distress relay again.

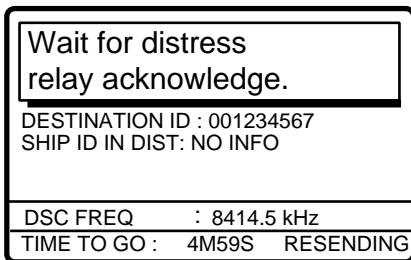

When you receive the distress relay acknowledge message, the audio alarm sounds and the display shown below appears.

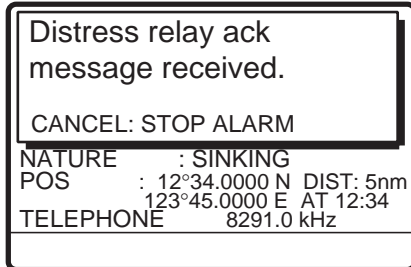

18. Press the **CANCEL** key to silence the audio alarm.

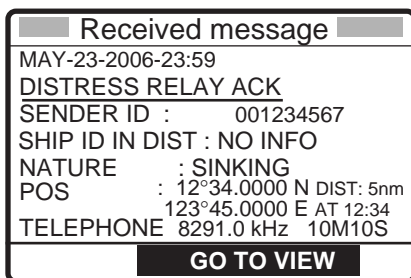

19. Communicate with the coast station.

4. DISTRESS OPERATIONS

4.3.2 Sending distress relay to area ships

Use this procedure to send the distress relay to area ships.

1. Press the **DSC** key.

Select Message	
GENERAL	DISTRESS
INDIVIDUAL	RELAY AREA
PSTN MESSAGE	RELAY COAST
TEST MESSAGE	DISTRESS
GROUP MESSAGE	
AREA MESSAGE	SPECIAL
POSITION	
MMSI 123456789	UTC 01:53
POS 12°34.5678N	EPFS 01:54
123°45.6789E	

2. Rotate the **ENTER** knob to choose RELAY AREA and then push the **ENTER** knob.
3. Push the **ENTER** knob to open the AREA menu.
4. You can choose QUAD or CIRCLE to set the area. The geographical area call is for sending a call to all ships within the area you designate in your geographical area call. In the figure below, for example, the call will be sent to all ships within 24-34°N, 135-140°W (QUAD) and 34°N, 140°W, range: 5 NM (CIRCLE).

Compose msg.	
MSG TYPE: RELAY AREA	
AREA: CIRCLE	**°→ **°
QUAD	
SHIP ID IN DIST: 123456789	
NATURE: UNDESIGNATED	
POS: 34°45.0000 N	
135°45.0000 E AT 9:30	
COMM MODE	: TELEPHONE
DSC FREQ.	: 8414.5 kHz
GO TO VIEW	

AREA line display

QUAD

"34° N 140°W↓ 10°→ 5°"

CIRCLE

"34° 00N 140° 00W 0500NM"

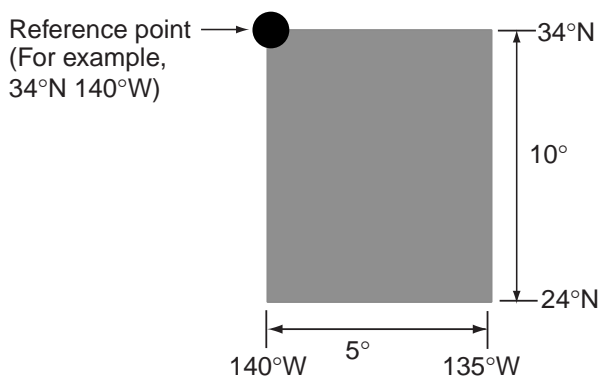

QUAD

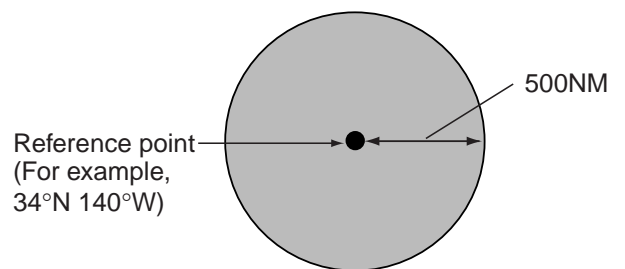

CIRCLE

5. Push the **ENTER** knob to open the SHIP ID IN DIST menu.
6. Rotate the **ENTER** knob to choose MANUAL or SELECT. For MANUAL, key in ID of ship in distress (if known) with the numeric keys and then push the **ENTER** knob. (If you do not know the ID, press the **CANCEL** key.)

7. Push the ENTER knob to open the NATURE menu.

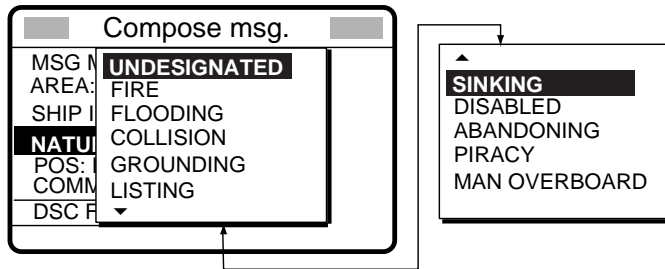

8. Rotate the **ENTER** knob to choose nature of distress and then push the **ENTER** knob. (If you do not know the nature of distress, choose UNDESIGNATED.)
9. Push the **ENTER** knob to open the POS. menu, where you enter the position of the ship in distress and time, manually or automatically.

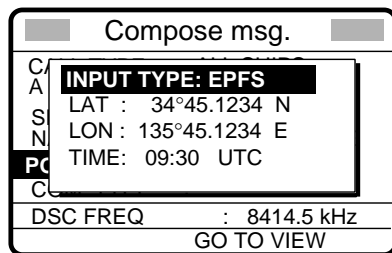

10. Enter position of the ship in distress, following 1), 2) or 3) below.
- 1) **For automatic input**, push the **ENTER** knob and choose EPFS. Then push the **ENTER** knob and go to step 10.
 - 2) **For manual input**, push the **ENTER** knob to open the INPUT TYPE menu, rotate the **ENTER** knob to choose MANUAL and then push the **ENTER** knob. Enter latitude and longitude of ship in distress and time as follows:
 - a) Push the **ENTER** knob. Enter latitude and then push the **ENTER** knob.
 - b) Push the **ENTER** knob. Enter longitude and then push the **ENTER** knob.
 - c) Push the **ENTER** knob. Enter UTC time and then push the **ENTER** knob. Go to step 10.
 - 3) **If you cannot confirm position of ship in distress**, push the **ENTER** knob to open the INPUT TYPE menu, rotate the **ENTER** knob to choose NO INFO and then push the **ENTER** knob twice. Go to step 10.

Note: If you cannot confirm time, enter 88:88 to input NO INFO as the time.

11. Push the **ENTER** knob to open the COM. MODE menu.

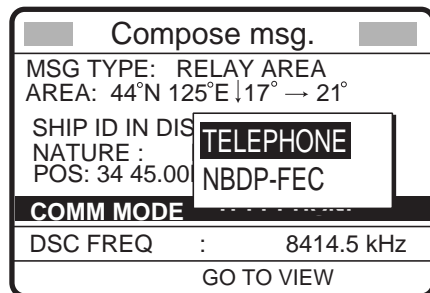

12. Rotate the **ENTER** knob to choose TELEPHONE (or NBDP-FEC) and then push the **ENTER** knob.

4. DISTRESS OPERATIONS

13. Push the **ENTER** knob to open the DSC FREQ menu.

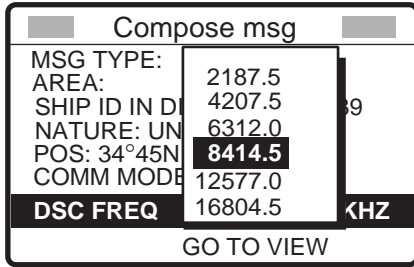

14. Rotate the **ENTER** knob to choose appropriate frequency and then push the **ENTER** knob. The display now looks something like the one below.

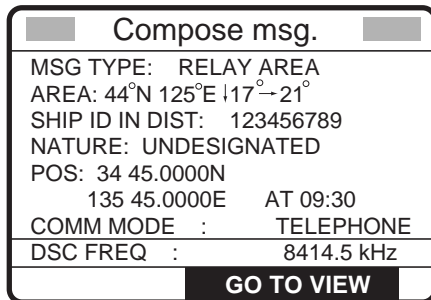

15. Press the **CALL** key for three seconds, and the message “Priority distress transmit sure?” appears. Continue pressing the key until the display shows “Distress relay area message in progress!” to send the distress relay call.

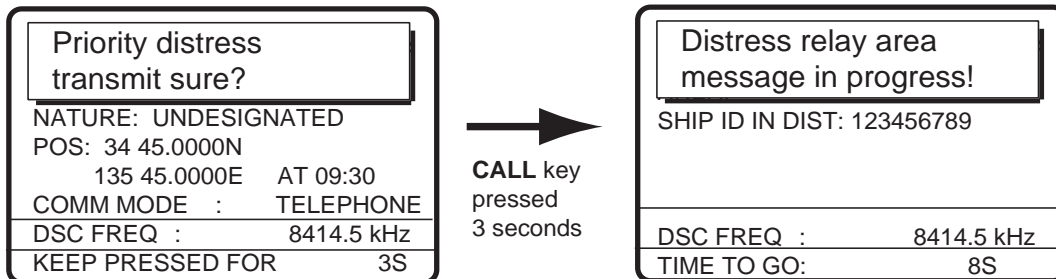

4.4 Receiving Distress Relay from Coast Station

Your ship receives the distress relay when:

- the coast station sends the distress relay to your ship. (DISTRESS RELAY COAST)
- the coast station sends the distress relay to the area where you are navigating.

When you receive a distress relay message from a coast station, continue monitoring distress and safety frequencies. The audio alarm sounds and the display looks like the one in the left-hand figure below when a distress relay is received from a coast station.

1. Press the **CANCEL** key to silence the audio alarm, and the display changes as in the right-hand figure below.

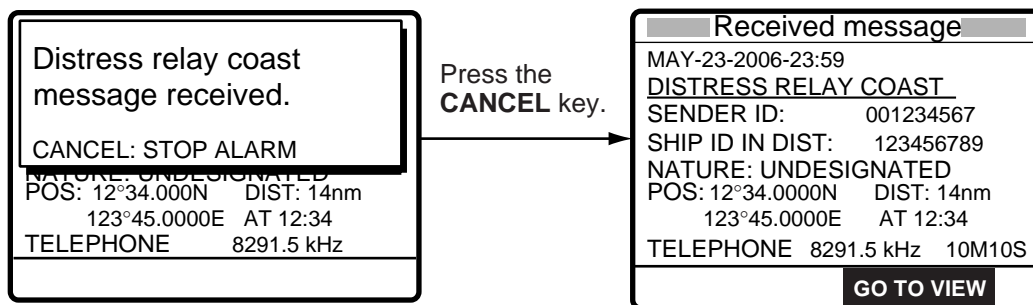

2. Press the **CANCEL** key to go to the radiotelephone screen.
3. Watch distress/safety frequency.

4.5 Cancelling Distress Call

You can cancel the distress call while it is being sent or while waiting for its acknowledgement as follows.

1. Press the **CANCEL** key to show the following display. The following message appears.

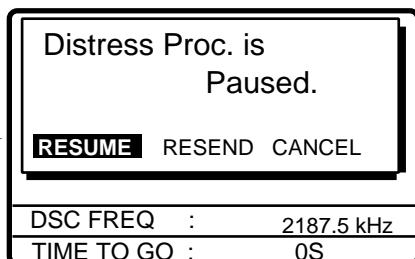

4. DISTRESS OPERATIONS

2. Choose CANCEL and push the **ENTER** knob to cancel the distress call.

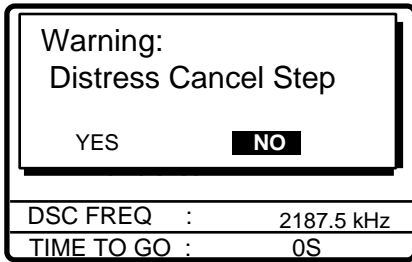

3. Rotate the ENTER knob to choose YES, and then push the **ENTER** knob to show the following screen. The screen shows the used frequencies to send.

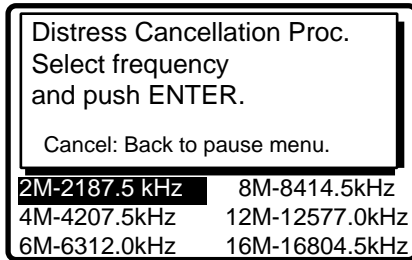

4. Rotate the **ENTER** knob to choose the frequency which was used to send, and then press the **ENTER** knob.

The cancellation message is transmitted over the same frequency used to transmit the distress call.

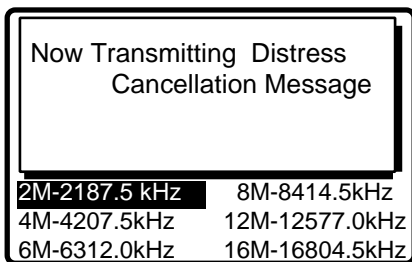

5. When the following screen appears, communicate with all ships via radio telephone.

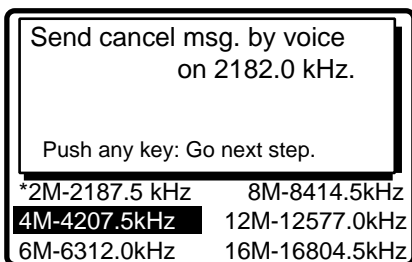

Asterisk marks the frequency over which the cancellation call was transmitted..

6. Press any key.

If you used other frequencies to send the distress call, the Distress Cancel sending starts over the next frequency to yourself. In this case, repeat step 3.

7. Repeat steps 4 through 6 to cancel for all frequencies.

When all cancellation is completed, the RT display appears.

5. ROUTINE MESSAGE CALLING, RECEIVING

Operation overview

The following shows about the individual message as example of the routine message. The individual call is for sending a call to a specific station.

1. Send the individual message.
2. Wait for the individual message acknowledgement.
3. Start the communication.

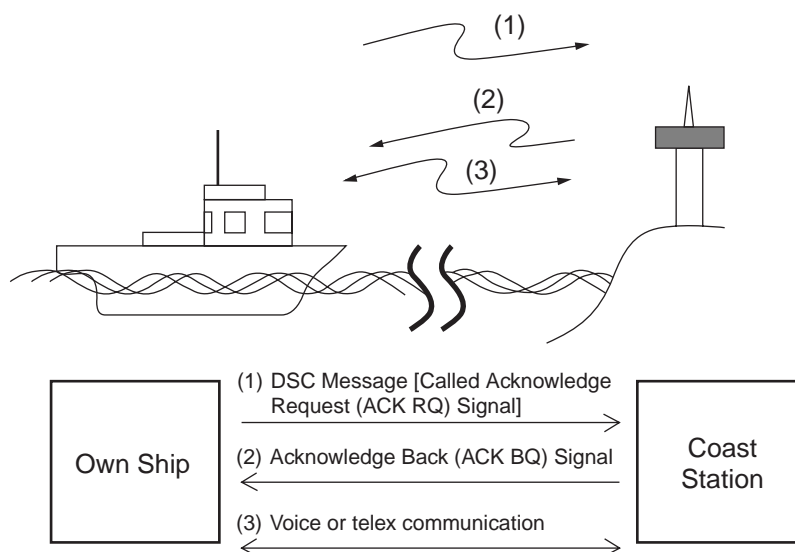

5.1 Individual Call

The individual call is for calling a specific station. After sending an individual call, called ACK RQ transmission, wait to receive the acknowledge back (ACK BQ) signal from the receiving station.

5.1.1 Sending an individual call

1. Press the DSC key.

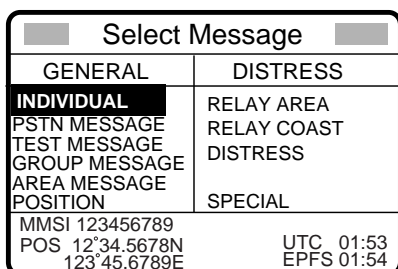

2. Rotate the **ENTER** knob to choose **INDIVIDUAL** and then push the **ENTER** knob.

5. ROUTINE MESSAGE CALLING, RECEIVING

3. Push the **ENTER** knob to open the STATION ID menu, and then rotate the ENTER knob to choose MANUAL or SELECT.
4. For SELECT, you can choose an ID from the message file list stored.
5. For MANUAL, use the numeric keys to key in the ID of the station where to send the call and then push the **ENTER** knob.

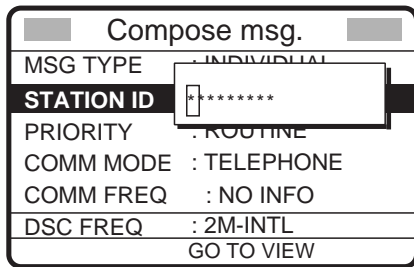

6. Push the **ENTER** knob to open the PRIORITY menu.

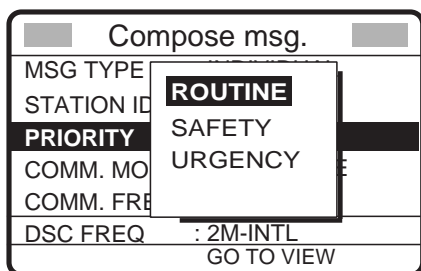

7. Rotate the **ENTER** knob to choose appropriate priority (normally ROUTINE) and then push the **ENTER** knob.
8. Push the **ENTER** knob to open the COMM MODE menu.

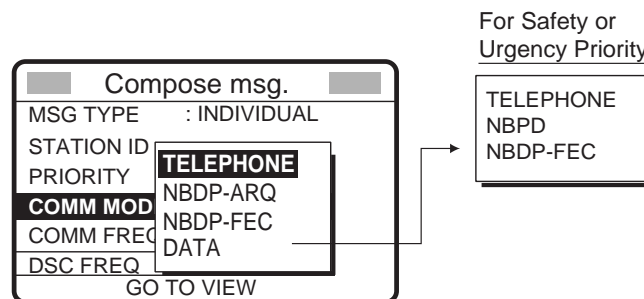

9. Rotate the **ENTER** knob to choose communications type desired and then push the **ENTER** knob.
10. For routine priority, push the **ENTER** knob to open the COMM FREQ menu. For safety and urgency priority, go to step 12.

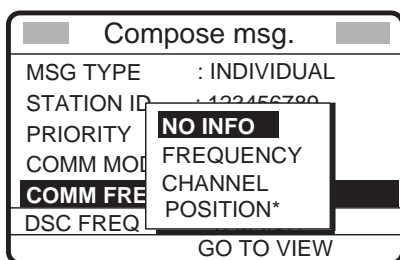

* POSITION is displayed if a coast station is specified at step 4.

11. Rotate the **ENTER** knob to choose communication frequency setting method desired and then push the **ENTER** knob. For FREQUENCY and CHANNEL, see “How to Set Working Frequency, Channel” on the next page. NO INFO and POSITION let the receiving station set the working frequency. Choose NO INFO or POSITION to send the call to a coast station; FREQUENCY or CHANNEL to send the call to a ship station.

How to Set Working Frequency, Channel

To send a call, set the working frequency as below, to communicate with the receiving station. The working frequency can be entered by Tx and Rx frequencies or channel number.

Routine priority

8. After selecting FREQUENCY or CHANNEL, one of the following pop-up windows appears.

TX: 0.0 kHz RX: 0.0 kHz	TRX: 0.0 kHz	CH: 0
(Coast station, Duplex)	(Mobile station, Simplex)	Channel
Frequency		

- a) Key in TX frequency or channel with the numeric keys. For channel, push the **ENTER** knob to finish.
- b) Rotate the **ENTER** knob to choose the RX field, key in RX frequency and then push the **ENTER** knob to finish.

Safety or urgency priority

For safety or urgency priority the communication frequency cannot be selected; it is automatically set to the pair frequency as set for the DSC frequency.

12. Follow the instructions on the next page to choose DSC frequency desired.

How to Set DSC Frequency

1. Rotate the **ENTER** knob to choose DSC FREQ and then push the **ENTER** knob.

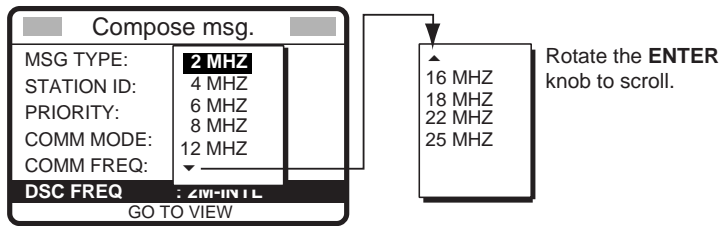

2. Rotate the **ENTER** knob to choose appropriate DSC band and then push the **ENTER** knob. One of the menus shown below appears depending on the band selected.

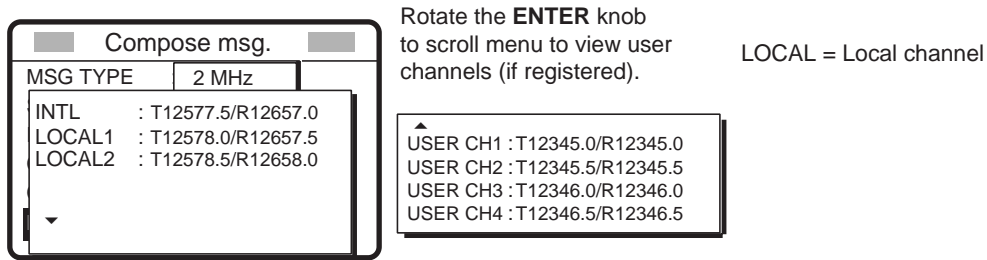

2MHz menu
INTL :T 2189.5/R 2177.0

8MHz menu
INTL :T 8415.0/R 8436.5
LOCAL :T 8415.5/R8437.0
LOCAL :T 8416.0/R8437.5

18MHz menu
INTL :T18898.5/R19703.5
LOCAL1 :T18899.0/R19704.0
LOCAL2 :T18899.5/R19704.5

4MHz menu
INTL :T 4208.0/R 4219.5
LOCAL1 :T 4208.5/R 4220.0
LOCAL2 :T 4209.0/R 4220.5

12MHz menu
INTL :T 12577.5/R12657.0
LOCAL1 :T 12578.0/R12657.5
LOCAL2 :T 12578.5/R12658.0

22MHz menu
INTL :T 22374.5/R22444.0
LOCAL1 :T 22375.0/R22444.5
LOCAL2 :T 22375.5/R22445.0

6MHz menu
INTL :T 6312.5/R 6331.0
LOCAL1 :T 6313.0/R 6331.5
LOCAL2 :T 6313.5/R 6332.0

16MHz menu
INTL :T 16805.0/R16903.0
LOCAL1 :T 16805.5/R16903.5
LOCAL2 :T 16806.0/R16904.0

25MHz menu
INTL :T 25208.5/R26121.0
LOCAL1 :T 25209.0/R26121.5
LOCAL2 :T 25209.5/R26122.0

3. Rotate the **ENTER** knob to choose DSC frequency and then push the **ENTER** knob. The display shows the DSC frequency band selected, at "DSC FREQ".

Safety or urgency priority

For safety and/or urgency priority "COMM FREQ" is automatically set to the same pair frequency as the DSC frequency.

1. Rotate the **ENTER** knob to choose DSC FREQ and then push the **ENTER** knob.

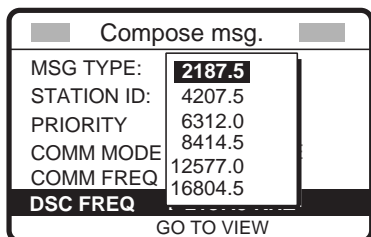

2. Rotate the **ENTER** knob to choose appropriate frequency and then push the **ENTER** knob.

13. Press the **CALL** key to send the individual call (transmission time: about seven seconds). The display shows the message "Individual routine message in progress!" while the call is being sent.

Individual routine message in progress!	
DESTINATION ID:	123456789
PRIORITY :	ROUTINE
TELEPHONE	2138.0 kHz
DSC FREQ :	2177.0 kHz
TIME TO GO:	7S

Note: When the channel is in use, "CH BUSY" appears at the lower left-hand side of the screen. Press **CALL** key for forced transmission.

After the call is sent, the equipment waits for acknowledgement of the call, showing the display below.

Waiting for acknowledgement.	
DESTINATION ID:	123456789
PRIORITY :	ROUTINE
TELEPHONE	2138.0 kHz
DSC FREQ :	2177.0 kHz
TIME TO GO:	4M30S RESENDING

The timer starts counting down the maximum time to wait for acknowledgement, five minutes. One of the following three messages appears. ("No response! Try calling again?" appears after the timer counts down to zero. It means the receiving station did not respond.)

Able acknowledge message received.	
CANCEL: STOP ALARM	
PRIORITY :	ROUTINE
TELEPHONE	2138.0 kHz

Able acknowledge call received

Unable acknowledge message received.	
CANCEL: STOP ALARM	
SENDER ID :	123456789
PRIORITY :	ROUTINE

Unable acknowledge call received

No response! Try calling again?	
DESTINATION ID:	123456789
PRIORITY :	ROUTINE
TELEPHONE	2138.0 kHz
DSC FREQ :	2177.0 kHz
RESEND	

No response from station (appears when the timer counts to "zero")

14. Do one of the following depending on the message shown in step 12.

5. ROUTINE MESSAGE CALLING, RECEIVING

Able acknowledge call received

Communicating by radiotelephone

1. Press the **CANCEL** key to silence the audio alarm, and the display changes as below.

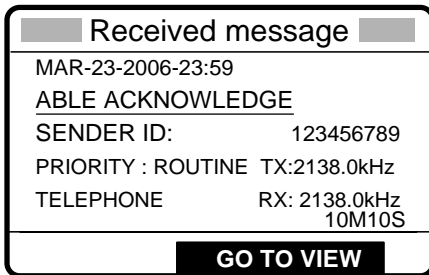

2. Press the **CANCEL** key to go to the radiotelephone screen.
3. The working frequency is automatically set; you may start voice communications by radiotelephone.

Sending message by NBDP Terminal Unit

The message "STATION ENTRY COMPLETED FROM DSC. Press any key to escape." Appears on the NBDP's display.

1. Press any key on the NBDP Terminal Unit to erase the message.
2. Press the function key F3 on the keyboard of the NBDP Terminal Unit to show the Operate menu.
3. Choose "Call Station" and then press the Enter key.
4. "DSC" is selected; press the Enter key. "Connect" appears in reverse video.
5. Type and transmit your message.
6. When you have finished sending your message, press the **F10** key to disconnect the line.

Unable acknowledge call received

1. Press the **CANCEL** key to silence the alarm. The display looks something like the one below.

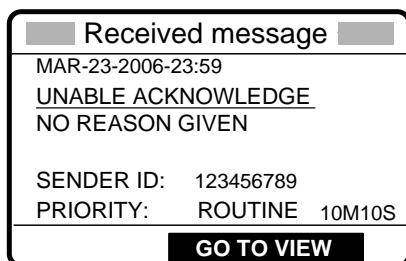

Reason for unable to acknowledge:
NO REASON GIVEN
CONGESTION AT SWITCHING CENTRE*
BUSY
QUEUE INDICATION*
STATION BARRED*
NO OPERATOR AVAILABLE*
OPERATOR TEMPORARILY UNAVAILABLE*
EQUIPMENT DISABLE
MODE NOT USABLE
CHANNEL NOT USABLE

* Coast station use

2. If the coast station sends the message "QUEUE INDICATION," wait until your turn arrives.

No response! Try calling again?

Re-send call: Push the **ENTER** knob followed by pressing the **CALL** key.

Cancel call: Press the **CANCEL** key to go to DSC screen.

5.1.2 Receiving an individual call

Acknowledgement is able or unable depending on the comply-type setting (see section 6.11). The relationship between comply type and able/unable acknowledge is as shown in the table below.

Setting for ACK/SQ key	ABLE	UNABLE
AUTO ACK	Can send ABLE acknowledge automatically	Can send UNABLE acknowledge automatically.
MANUAL ACK	Send ABLE acknowledge manually	Send UNABLE acknowledge manually

Note: The handset must be on hook to enable automatic acknowledge.

Sending automatic acknowledge (ACK BQ) with comply type “ABLE”

When an individual call is received and the automatic acknowledge feature is active (AUTO ACK) and the comply type is “ABLE,” the display shown below appears. This display indicates that the auto acknowledge (ACK BQ) call is being sent.

Able acknowledge message in progress!	
DESTINATION ID:	123456789
PRIORITY :	ROUTINE
TELEPHONE	2138.0 kHz
DSC FREQ :	2177.0 kHz
TIME TO GO:	6S

It takes about seven seconds to transmit the call, after which the audio alarm sounds and the following message appears.

Able acknowledge message transmitted.	
CANCEL: STOP ALARM	
PRIORITY: ROUTINE TX:	2138.0 kHz
TELEPHONE	RX: 2138.0 kHz

1. Press the **CANCEL** key to silence the alarm. The following display appears.

5. ROUTINE MESSAGE CALLING, RECEIVING

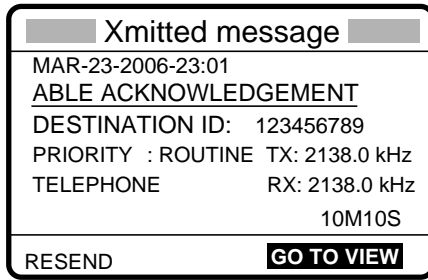

2. Press the **CANCEL** key. You can now communicate with the party, over the radiotelephone frequency specified or by the NBDP terminal unit.

Communicating by NBDP Terminal Unit

After acknowledging an individual call, do the following to communicate by NBDP Terminal Unit. The control unit's display shows "OCCUPIED" and the Tx and Rx frequencies. The message from the other station appears on your NBDP Terminal Unit.

1. After receiving the message from other station, type your message and then transmit it.
2. Press the function key **F10** (BREAK) to disconnect the line.

Sending automatic acknowledge (ACK BQ) with comply type "UNABLE"

When an individual call is received and the automatic acknowledge feature is active (AUTO ACK) and comply type is "UNABLE," the display shown below appears, indicating that the auto acknowledge call (ACK BQ) with UNABLE is being sent.

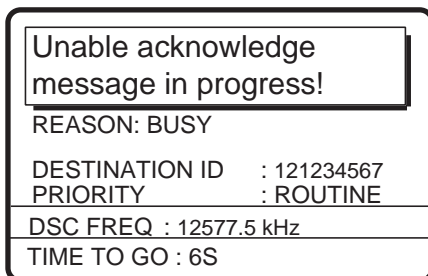

It takes about seven seconds to transmit the call, after which the audio alarm sounds and the following message appears.

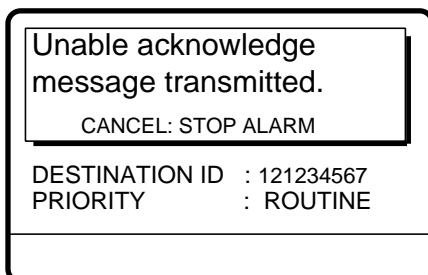

1. Press the **CANCEL** key to silence the alarm. The following display appears.

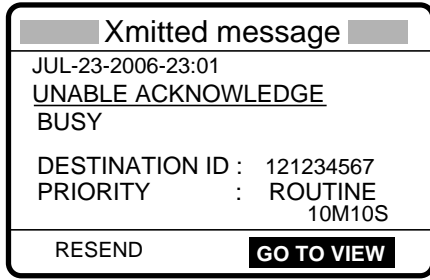

2. Push the **ENTER** knob to confirm the message.
3. Rotate the **ENTER** knob to scroll the message.

Manually acknowledging individual call with “ABLE”

When an individual call is received and the equipment is set up with manual acknowledge (MANUAL ACK), the alarm sounds and the display looks like the one below.

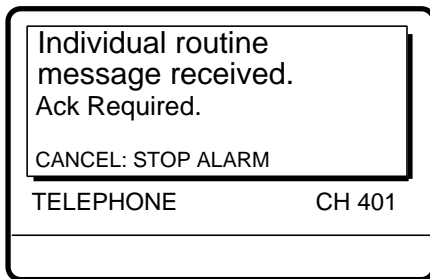

1. Press the **CANCEL** key to silence the alarm. The display changes as shown below.

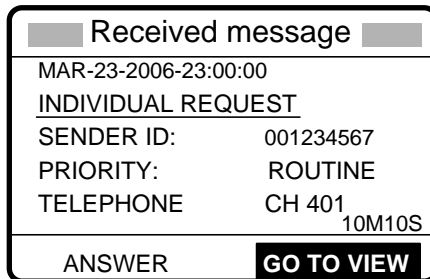

To view contents, rotate **ENTER** knob to choose GO TO VIEW and then push **ENTER** knob.

2. Rotate the **ENTER** knob to choose ANSWER and then push the **ENTER** knob.
3. Rotate the **ENTER** knob to choose MSG TYPE and then push the **ENTER** knob.

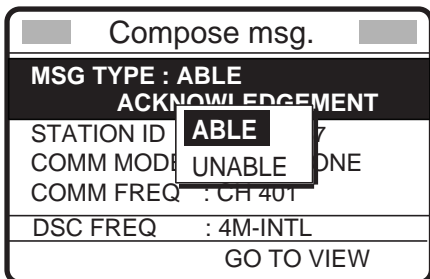

4. Rotate the **ENTER** knob to choose ABLE and then push the **ENTER** knob. The display changes as below.

5. ROUTINE MESSAGE CALLING, RECEIVING

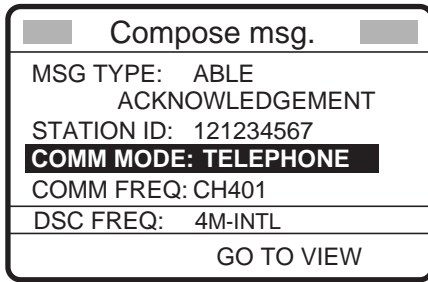

5. Press the **CALL** key to send the acknowledge call. The display changes as below.

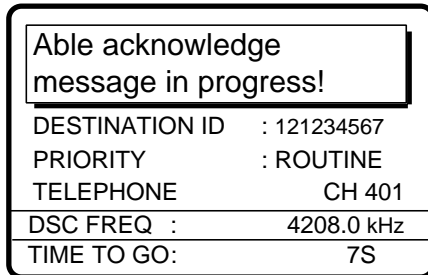

6. After the call is completely sent (transmission time: 7 sec.), push the **CANCEL** key twice to show the radiotelephone screen (if the communications mode is telephone).
7. You can begin voice communications by radiotelephone. For NBDP operation, do the following:

Communicating by NBDP Terminal Unit

After acknowledging an individual call, do the following to communicate by NBDP Terminal Unit. The control unit's display shows "OCCUPIED" and the Tx and Rx frequencies. The message from the other party appears on your NBDP Terminal Unit.

1. After receiving the message from the other party, type your message and transmit it.
2. Press the function key F10 (BREAK) to disconnect the line.

Manually acknowledging individual call with "UNABLE"

When an individual call is received and the equipment is set up with manual acknowledge, the alarm sounds and the display shows the message "Individual xxx (priority name) message received."

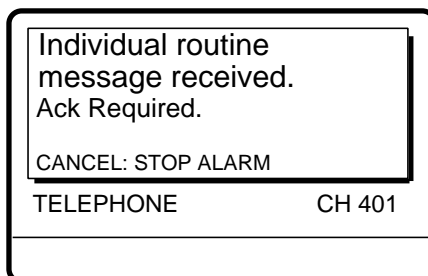

1. Press the **CANCEL** key to silence the alarm. The display changes as below.



To view contents, rotate **ENTER** knob to choose GO TO VIEW and then push the **ENTER** knob.

2. Rotate the **ENTER** knob to choose ANSWER and then push the **ENTER** knob.
3. Rotate the **ENTER** knob to choose MSG TYPE and then push the **ENTER** knob.

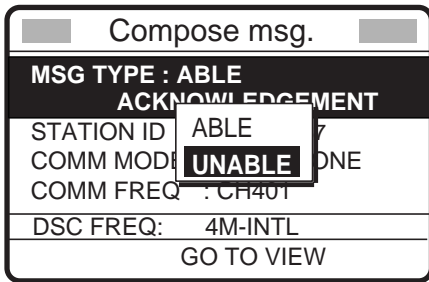

4. Rotate the **ENTER** knob to choose UNABLE and then push the **ENTER** knob.
5. Push the **ENTER** knob to open the REASON menu.

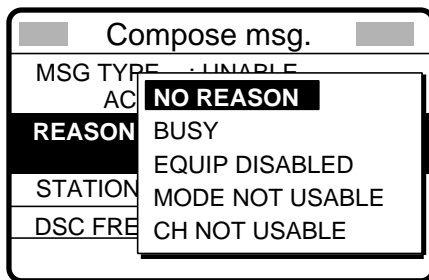

6. Rotate the **ENTER** knob to choose an appropriate reason and then push the **ENTER** knob. The display changes as below.

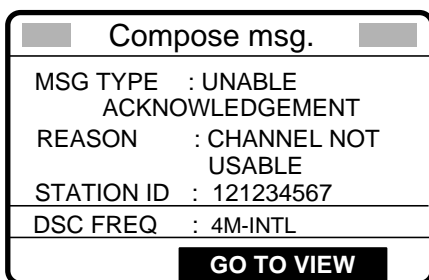

7. Press the **CALL** key to send the acknowledge call. The display shows "Unable acknowledge message in progress!" while the call is being sent.

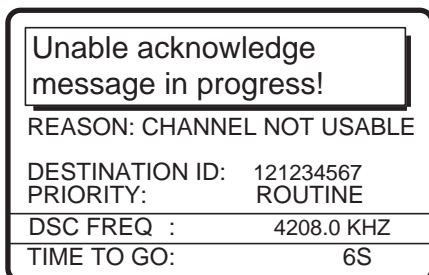

5. ROUTINE MESSAGE CALLING, RECEIVING

The timer counts down the time remaining until the call is completed (transmission time: about seven seconds).

8. Press the **CANCEL** key twice to show the radiotelephone screen.

5.2 Group Call

A group call is for calling a specific group by specifying its group ID.

5.2.1 Sending a group call

1. Press the **2/DSC** key.

Select Message	
GENERAL	DISTRESS
INDIVIDUAL	RELAY AREA
PSTN MESSAGE	RELAY COAST
TEST MESSAGE	DISTRESS
GROUP MESSAGE	
AREA MESSAGE	SPECIAL
POSITION	
MMSI 123456789	
POS 12°34.5678N	UTC 01:53
123°45.6789E	EPFS 01:54

1. Choose **GROUP MESSAGE** and then push the **ENTER** knob.
2. Push the **ENTER** knob to open the **GROUP ID** menu, and then rotate the **ENTER** knob to choose **MANUAL** or **SELECT**.
3. For **SELECT**, you can choose an ID from the message file list stored.
4. For **MANUAL**, key in group ID (eight digits) with the numeric keys and then push the **ENTER** knob.

Compose msg.	
MSG TYPE	: GROUP MESSAGE
GROUP ID	0 * * * * * * * *
PRIORITY	: ROUTINE
COMM MODE	: TELEPHONE
COMM FREQ	: NO INFO
DSC FREQ	: 2M-INTL
GO TO VIEW	

5. Push the **ENTER** knob to open the **COMM MODE** menu.

Compose msg.	
MSG TYPE	TELEPHONE
GROUP ID	NBDP-FEC
PRIORITY	
COMM MODE	: TELEPHONE
COMM FREQ	: NO INFO
DSC FREQ	: 2M-INTL
GO TO VIEW	

6. Rotate the **ENTER** knob to choose communication type desired and then push the **ENTER** knob.
7. Push the **ENTER** knob to open the **COMM FREQ** menu.

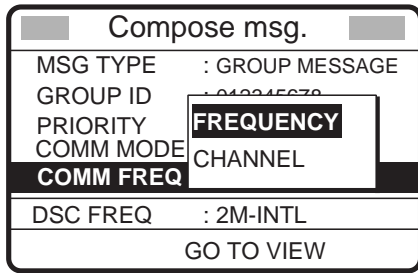

8. Rotate the **ENTER** knob to choose communication frequency desired and then push the **ENTER** knob. (See page 5-3 for details.) NO INFO lets other party choose communication frequency.
9. Push the **ENTER** knob to open the DSC FREQ menu.

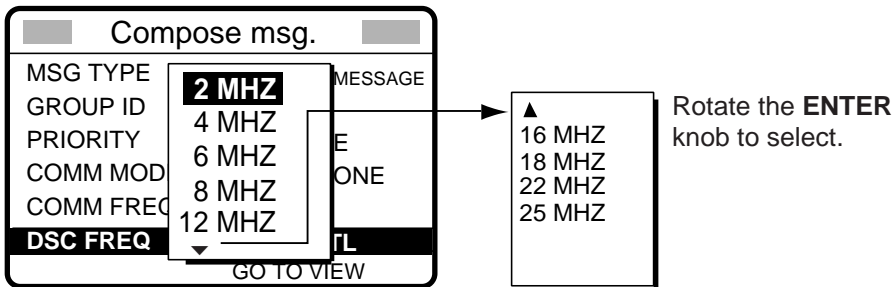

10. Rotate the **ENTER** knob to choose DSC band desired and then push the **ENTER** knob to open the DSC FREQ menu.
11. Rotate the **ENTER** knob to choose DSC frequency desired and then push the **ENTER** knob. (See “How to Set DSC Frequency” on page 5-4 for details.)

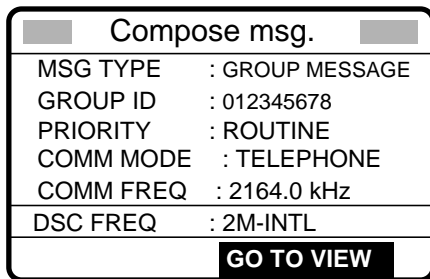

12. Press the **CALL** key to send the group call (transmission time: about seven seconds). The display shows “Group message in progress!” while the call is being sent.

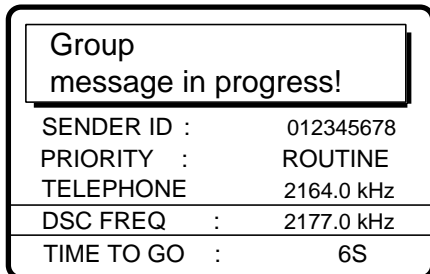

13. Press the **CANCEL** key twice to show the radiotelephone screen after the call is sent.
14. If you selected TELEPHONE at step 7, communicate by radiotelephone. For NBDP, do the following:

Sending message by NBDP Terminal Unit

The message “STATION ENTRY COMPLETED FROM DSC. Press any key to escape.” Appears on the NBDP’s display.

1. Press any key on the NBDP Terminal Unit to erase the message.
2. Press the function key F3 on the keyboard of the NBDP Terminal Unit to show the Operate menu.
3. Choose “Call Station” and then press the Enter key.
4. “DSC” is selected; press the Enter key. “Connect” appears in reverse video.
5. Type and transmit your message.
6. When you have finished sending your message, press the F10 key to disconnect the line.

5.2.2 Receiving a group call

Group ID must be registered in order to receive a group call.

The audio alarm sounds and the display shows “Group message received” when a group call is received.

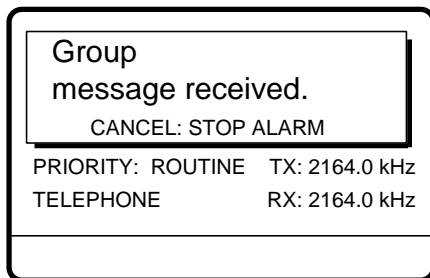

1. Press the **CANCEL** key to silence the alarm. The display changes as below.

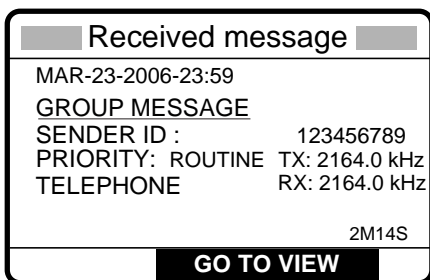

2. Press the **CANCEL** key to go to the radiotelephone screen. Watch on the working frequency. If there is the difference between the registered frequency and used frequency to receive, the following screens appear. Choose Agree for the voice communication, or Disagree when you do not change the frequency.

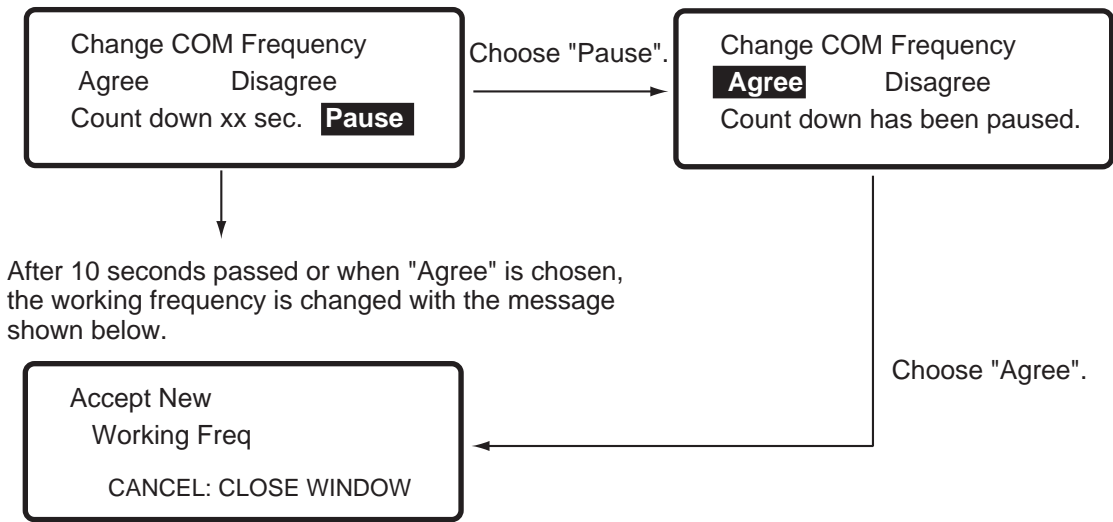

Receiving message by NBDP Terminal Unit

After receiving a group call, confirm the following.

- The control unit's display shows "OCCUPIED" and the Tx and Rx frequencies.
- The message from the sending station appears on your NBDP Terminal Unit.

5.3 Geographical Area Call

The geographical area call is for sending a call to all ships within the area you designate in your geographical area call. In the figure below, for example, the call will be sent to all ships within 24-34°N, 135-140°W (QUAD) and 34°N, 140°W, range: 500 NM (CIRCLE).

Note: At the high-latitude area, set the area so that the longitude is within 99°. If the setting is over 99°, it may be adjusted automatically.

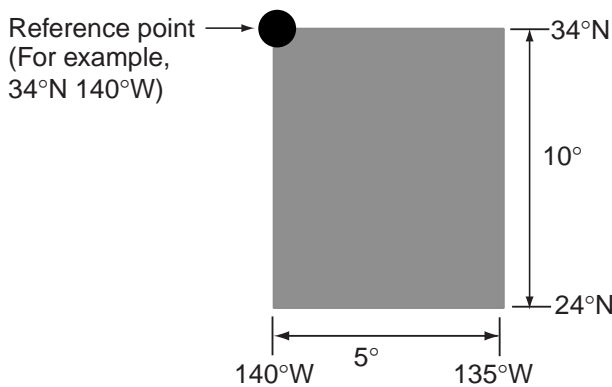

QUAD

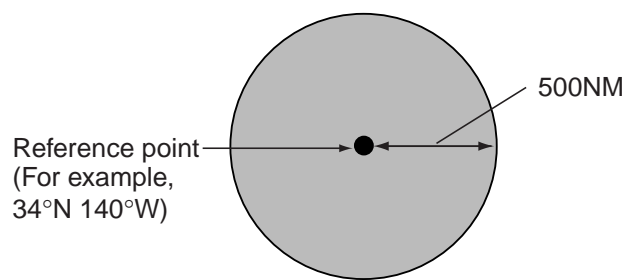

CIRCLE

5. ROUTINE MESSAGE CALLING, RECEIVING

5.3.1 Sending a geographical area call

1. Press the **2/DSC** key.

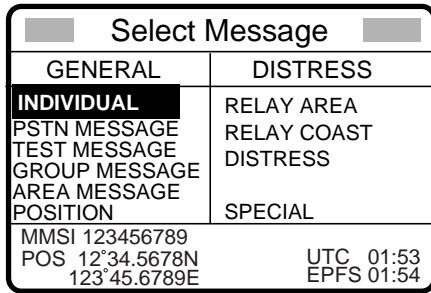

2. Rotate the **ENTER** knob to choose AREA MESSAGE and then push the **ENTER** knob.
3. Push the **ENTER** knob to open the AREA menu, then choose QUAD or CIRCLE and push the **ENTER** knob.

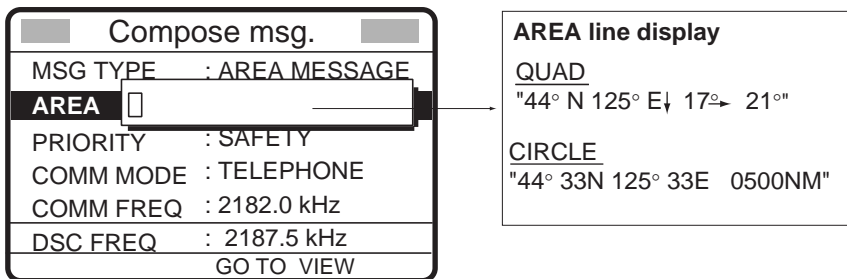

4. **For QUAD:** Using the numeric keys, enter latitude and longitude of reference point and southerly degrees and easterly degrees of area. To change coordinate, choose it and press the **1** key for North or East; **2** key for South or West. After entering data, push the **ENTER** knob.
5. **For CIRCLE:** Using the numeric keys, enter latitude and longitude of reference point and radius of area. To change coordinate, choose it and press the **1** key for North or East; **2** key for South or West. After entering data, push the **ENTER** knob.
6. Push the **ENTER** knob to open the PRIORITY menu.
7. Rotate the **ENTER** knob to choose priority desired and then push the **ENTER** knob.
8. Push the **ENTER** knob to open the COM. MODE menu.

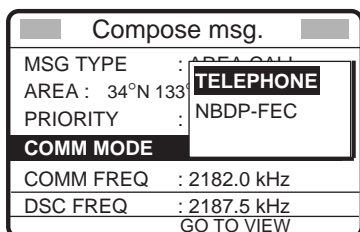

9. Rotate the **ENTER** knob to choose communication type desired and then push the **ENTER** knob.
10. Push the **ENTER** knob to open the DSC FREQ menu.

11. Rotate the **ENTER** knob to choose DSC frequency desired and then push the **ENTER** knob. (See “How to Set DSC Frequency” on page 5-4 for details.) Your display should now look something like one below.

Compose msg.	
MSG TYPE	: AREA MESSAGE
AREA	: 34°N 140°W ↓10° →5°
PRIORITY	: SAFETY
COMM MODE	: TELEPHONE
COMM FREQ	: 2182.0 kHz
DSC FREQ	: 2187.5 kHz
GO TO VIEW	

12. Press the **CALL** key to send the geographical area call (transmission time: about seven seconds). The display shows “Geographical area message in progress!” while the call is being sent.

Geographical area message in progress!	
AREA	: 34°N 140°W ↓10° →5°
PRIORITY	: SAFETY
TELEPHONE	: 2182.0 kHz
DSC FREQ	: 2187.5 kHz
TIME TO GO	: 7S

13. After the call is sent, press the **CANCEL** key twice to show the radiotelephone screen.
14. If you chose TELEPHONE at step 8, you can now communicate with the other party. For NBDP, do the following:

Sending message by NBDP Terminal Unit

The message “STATION ENTRY COMPLETED FROM DSC. Press any key to escape.” Appears on the NBDP’s display.

1. Press any key on the NBDP Terminal Unit to erase the message.
2. Press the function key **F3** on the keyboard of the NBDP Terminal Unit to show the Operate menu.
3. Choose “Call Station” and then press the **Enter** key.
4. “DSC” is selected; press the **Enter** key. “Connect” appears in reverse video.
5. Type and transmit your message.
6. When you have finished sending your message, press the **F10** key to disconnect the line.

5.3.2 Receiving a geographical area call

The alarm sounds and the display shows “Geographical area message received” when a geographical area message is received.

Geographical area message received.	
CANCEL: STOP ALARM	
PRIORITY	: SAFETY
TELEPHONE	: 2182.0kHz

5. ROUTINE MESSAGE CALLING, RECEIVING

1. Press the **CANCEL** key to silence the alarm. "Change COM Frequency" display appears, and the display changes as below.



3. Press the **CANCEL** key to go to the radiotelephone screen. Watch on the working frequency specified in the geographic area call. If there is the difference between the registered frequency and used frequency to receive, the following screens appear. Choose Agree for the voice communication, or Disagree when you do not change the frequency.

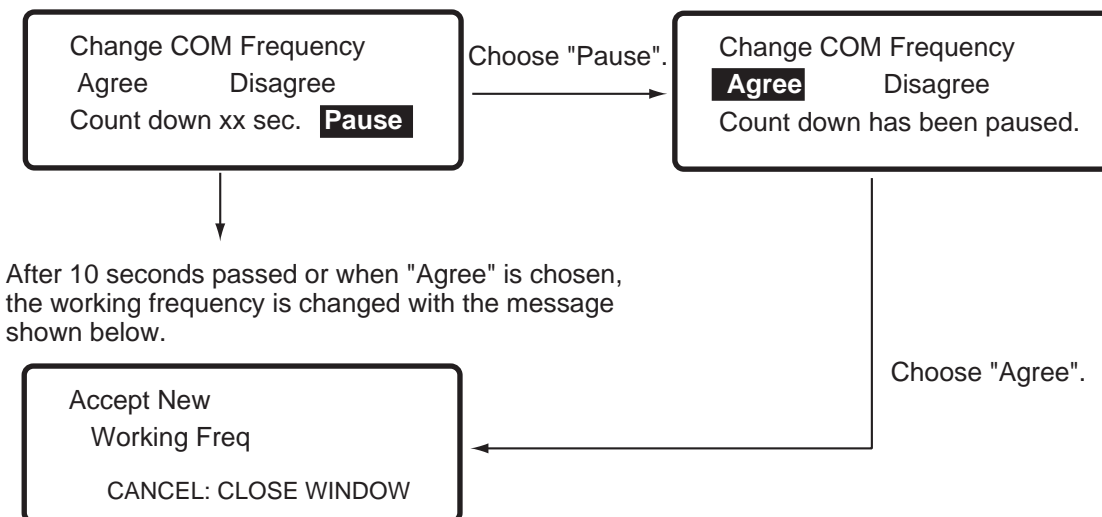

Receiving message by NBDP Terminal Unit

After receiving a geographic area call, confirm the following.

- The control unit's display shows "OCCUPIED" and the Tx and Rx frequencies.
- The message from the sending station appears on your NBDP Terminal Unit.

5.4 Neutral Craft Call

The neutral craft call, which contains own ship position and ID, informs all ships that your ship is not a participant in armed conflict. The neutral craft call is necessary the setting on the Setup menu. See section “6.15 Special Messages”.

5.4.1 Sending a neutral craft call

1. Press the **2/DSC** key.

Select Message	
GENERAL	DISTRESS
INDIVIDUAL	RELAY AREA
PSTN MESSAGE	RELAY COAST
TEST MESSAGE	DISTRESS
GROUP MESSAGE	
AREA MESSAGE	SPECIAL
POSITION	
MMSI 123456789	
POS 12°34.5678N	UTC 01:53
123°45.6789E	EPFS 01:54

2. Rotate the **ENTER** knob to choose SPECIAL and NEUTRAL in order and then push the **ENTER** knob.
3. Push the **ENTER** knob to open the AREA menu and enter the area range as shown on page 5-16.
4. Push the **ENTER** knob to open the COM. MODE menu.
5. Rotate the **ENTER** knob to choose communication type desired (TELEPHONE or NBDP-FEC) and then push the **ENTER** knob.
6. Push the **ENTER** knob to open the DSC FREQ menu.

Compose	
MSG TYPE	4207.5
	6312.0
	8414.5
AREA: 44°N 11	12577.0
PRIORITY	16804.5
COMM MODE	
DSC FREQ	2187.5
	kHz
GO TO VIEW	

7. Rotate the **ENTER** knob to choose appropriate frequency and then push the **ENTER** knob.

Compose msg.	
MSG TYPE :	NEUTRAL
	CRAFT
AREA :	44°N 140°W ↓10° → 5°
PRIORITY :	URGENCY
COMM MODE :	TELEPHONE
COMM FREQ :	2182.0 kHz
DSC FREQ :	2187.5 kHz
GO TO VIEW	

5. ROUTINE MESSAGE CALLING, RECEIVING

8. Press the **CALL** key to send the neutral craft call (transmission time: approx. 7 sec.).

Neutral craft message in progress!	
AREA : 34°N 140°W ↓ 10° → 5°	
PRIORITY: URGENCY	
DSC FREQ : 2187.5 kHz	
TIME TO GO: 7S	

9. After the call is sent, press the **CANCEL** key twice to show the radiotelephone screen.
10. Inform all ships by radiotelephone that your ship is not a participant in armed conflict.

Sending message by NBDP Terminal Unit

The message "STATION ENTRY COMPLETED FROM DSC. Press any key to escape."
Appears on the NBDP's display.

1. Press any key on the NBDP Terminal Unit to erase the message.
2. Press the function key **F3** on the keyboard of the NBDP Terminal Unit to show the Operate menu.
3. Choose "Call Station" and then press the **Enter** key.
4. "DSC" is selected; press the **Enter** key. "Connect" appears in reverse video.
5. Type and transmit your message.
6. When you have finished sending your message, press the **F10** key to disconnect the line.

5.4.2 Receiving a neutral craft call

When a neutral craft call is received the alarm sounds and the display changes as below.

Neutral craft message received.	
CANCEL: STOP ALARM	
PRIORITY: URGENCY	
TELEPHONE 2182.0 kHz	

1. Press the **CANCEL** key to silence the alarm. The working frequency confirmation window appears for 10 seconds. The display changes as below.

Received message	
MAR-23-2006-23:59	
<u>NEUTRAL CRAFT</u>	
SENDER ID: 123456789	
PRIORITY: URGENCY	
TELEPHONE 2182.0 kHz	
	10M10S
GO TO VIEW	

- Press the **CANCEL** key to go to the radiotelephone screen. Watch on the working frequency specified by radiotelephone or NBDP. If there is the difference between the registered frequency and used frequency to receive, the following screens appear. Choose Agree for the voice communication, or Disagree when you do not change the frequency.

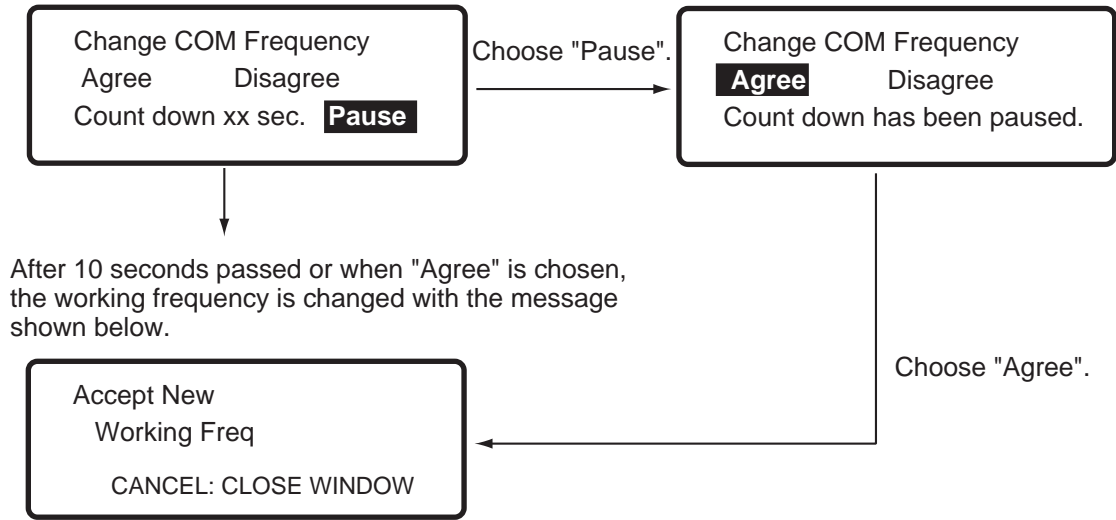

Receiving message by NBDP Terminal Unit

After receiving a neutral craft call, confirm the following.

The control unit’s display shows “OCCUPIED” and the Tx and Rx frequencies.

The message from the sending station appears on your NBDP Terminal Unit.

5.5 Medical Transport Call

The medical transport call informs all ships, by urgency priority, that own ship carries medical supplies. The medical call is enabled/disable with the Setup menu setting. See section “6.15 Special Messages”.

5.5.1 Sending a medical transport call

- Press the **2/DSC** key.

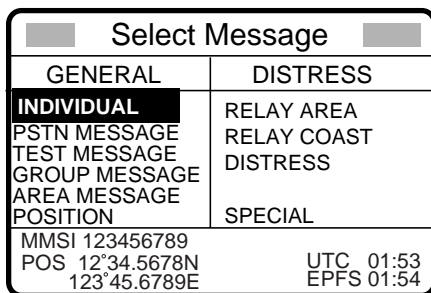

- Rotate the **ENTER** knob to choose SPECIAL and MEDICAL in order and then push the **ENTER** knob. PRIORITY is automatically selected to URGENCY.

5. ROUTINE MESSAGE CALLING, RECEIVING

3. Push the **ENTER** knob to open the AREA menu and then enter the area range as shown on page 5-17.
4. Push the **ENTER** knob to open the COMM MODE menu.
5. Rotate the **ENTER** knob to choose communication type desired (TELEPHONE or NBDP-FEC) and then push the **ENTER** knob.
6. Push the **ENTER** knob to open the DSC FREQ menu.

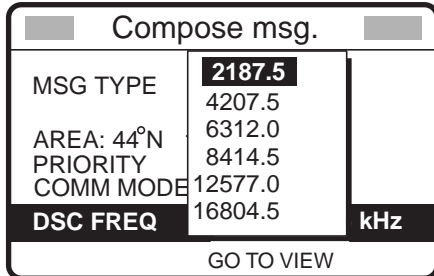

7. Rotate the **ENTER** knob to choose appropriate frequency and then push the **ENTER** knob. The display changes as below.

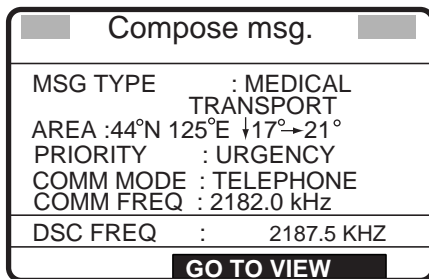

8. Press the **CALL** key to send the call (transmission time: about seven seconds). The display shows "Medical transport message in progress!" while the call is being sent.

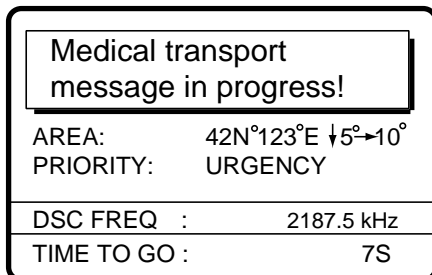

9. After the call is sent, press the **CANCEL** key twice to show the radiotelephone screen.
10. Inform all ships (by radiotelephone) that your ship is transporting medical supplies. For NBDP do the following:

Sending message by NBDP Terminal Unit

The message "STATION ENTRY COMPLETED FROM DSC. Press any key to escape." Appears on the NBDP's display.

1. Press any key on the NBDP Terminal Unit to erase the message.
2. Press the function key **F3** on the keyboard of the NBDP Terminal Unit to show the Operate menu.
3. Choose "Call Station" and then press the Enter key.
4. "DSC" is selected; press the Enter key. "Connect" appears in reverse video.
5. Type and transmit your message.

- When you have finished sending your message, press the F10 key to disconnect the line.

5.5.2 Receiving a medical transport call

When a medical transport call is received, the alarm sounds and the display changes as below.



- Press the **CANCEL** key to silence the alarm. After the "Change COM Frequency" display, the display changes as below.

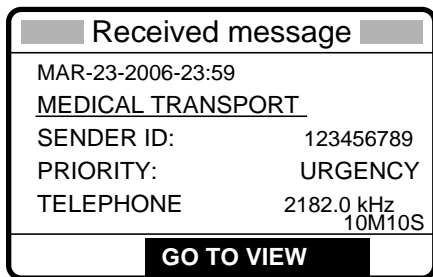

- Press the **CANCEL** key to go to the radiotelephone screen to watch on frequency specified. If there is the difference between the registered frequency and used frequency to receive, the following screens appear. Choose Agree for the voice communication, or Disagree when you do not change the frequency.

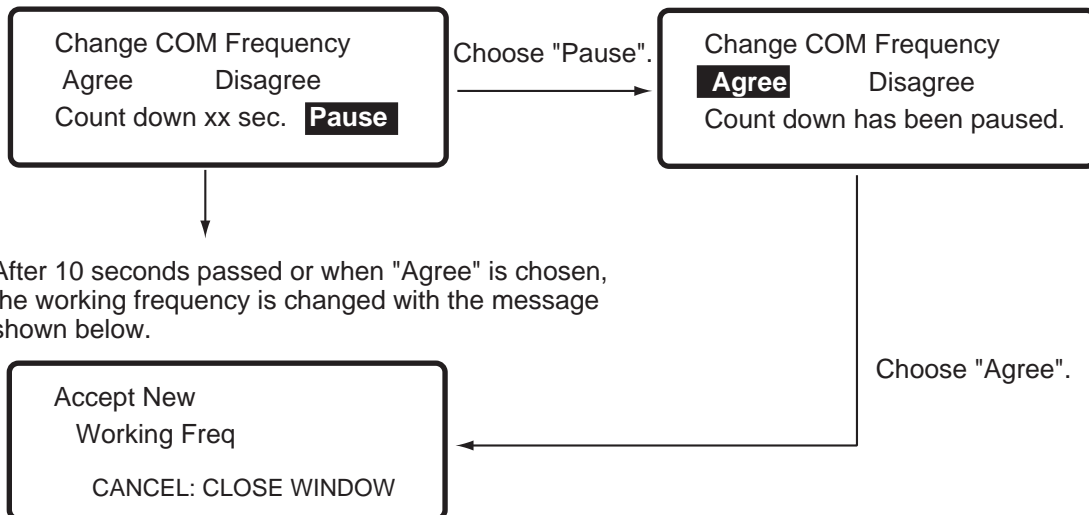

5. ROUTINE MESSAGE CALLING, RECEIVING

Receiving message by NBDP Terminal Unit

After receiving a medical transport area call, confirm the following.

The control unit's display shows "OCCUPIED" and the Tx and Rx frequencies.

The message from the sending station appears on your NBDP Terminal Unit.

5.6 Receiving a Polling Request

Polling means confirming if own station is within communicating range with other station.

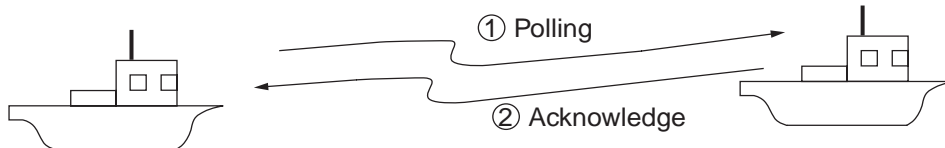

5.6.1 Automatic reply

The display changes as shown in the illustration below when a polling request message is received

Polling acknowledge message in progress!	
DESTINATION ID :	123456789
PRIORITY:	ROUTINE
DSC FREQ :	2177.0 kHz
TIME TO GO :	7S

The equipment is set up for automatic acknowledge: POLLING MESSAGE on the Auto Ack menu is ON and the **5/ACK/ SQ** key is set to show AUTO ACK on the display. For details see paragraph 6.11. (PRIORITY: ROUTINE only) After the polling acknowledge message is transmitted, the following display appears and the audio alarm sounds.

Polling acknowledge message transmitted.	
CANCEL: STOP ALARM	
PRIORITY:	ROUTINE

1. Press the **CANCEL** key to silence the alarm. The display changes as below.

Xmitted message	
MAR-23-2006-23:00:09	
POLLING ACKNOWLEDGE	
DESTINATION ID :	123456789
PRIORITY:	ROUTINE
10M10S	
RESEND	GO TO VIEW

2. Press the **CANCEL** key to return to the radiotelephone screen.

5.6.3 Manual reply

The display changes as shown in the illustration below. The audio alarm sounds when a polling request message is received and the status of the **5/ ACK/SQ** key is MANUAL ACK (or AUTO ACK and POLLING MESSAGE in AUTO ACK menu is OFF).

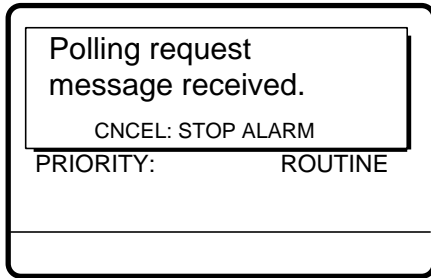

1. Press the **CANCEL** key to silence the alarm. The display changes as below.



2. To ignore the call, press the **CANCEL** key.
3. To respond to the call, rotate the **ENTER** knob to choose ANSWER and then push the **ENTER** knob. The display changes as below.

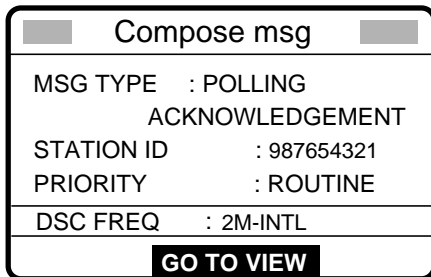

4. Press the **CALL** key to send the polling acknowledge message. The display changes as below.

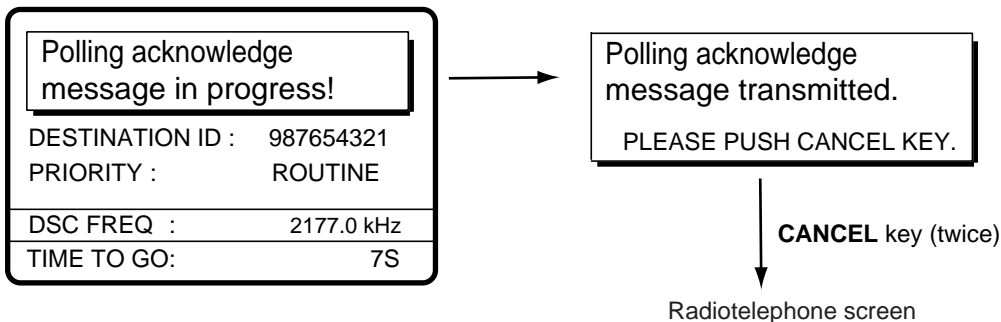

5.7 Position Call

There are two types of position calls: other station requires your ship's position and your ship requests position of another ship.

Finding position of other station

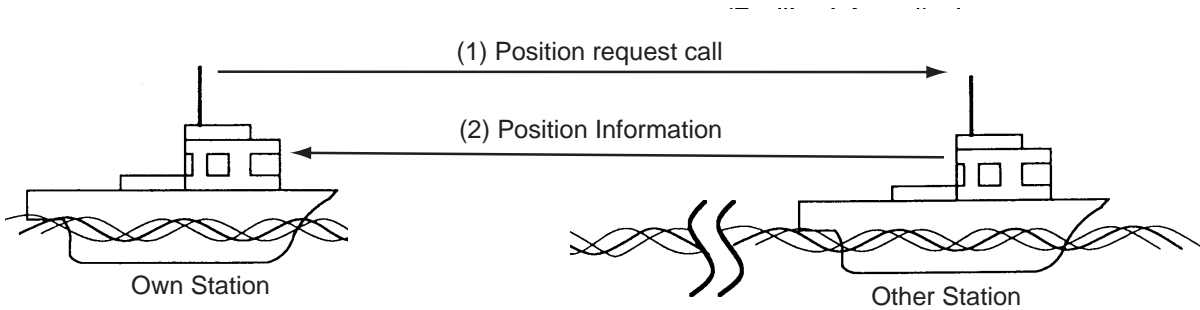

Sending own ship's position to other station

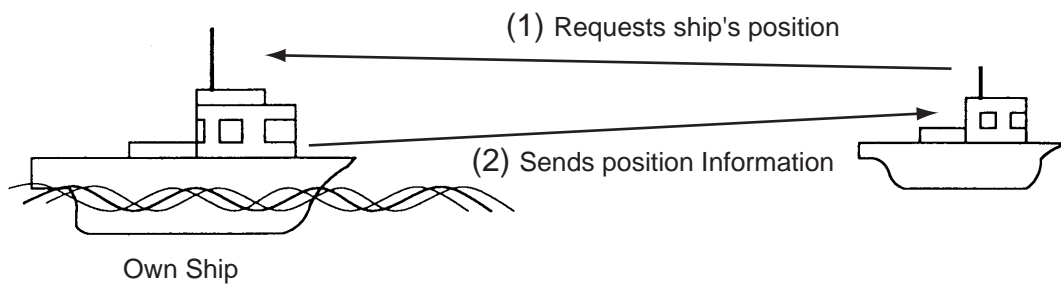

5.7.1 Requesting other ship's position

1. Press the **2/DSC** key.

Select Message	
GENERAL	DISTRESS
INDIVIDUAL	RELAY AREA
PSTN MESSAGE	RELAY COAST
TEST MESSAGE	DISTRESS
GROUP MESSAGE	
AREA MESSAGE	SPECIAL
POSITION	
MMSI 123456789	UTC 01:53
POS 12°34.5678N	MAN 01:54
123°45.6789E	

2. Rotate the **ENTER** knob to choose POSITION and then push the **ENTER** knob.

3. Push the **ENTER** knob to open the STATION ID menu, and then rotate the **ENTER** knob to choose MANUAL or SELECT. **For SELECT**, you can choose an ID from the message file list stored. **For MANUAL**, key in ID of station (nine digits) which you want to know its position and then push the **ENTER** knob.

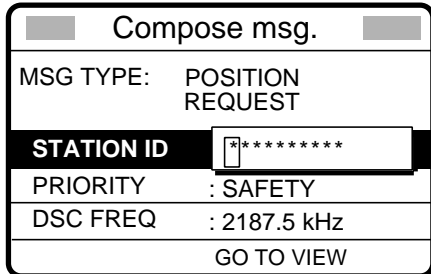

4. Push the **ENTER** knob to open the DSC FREQ menu, and then rotate the **ENTER** knob to choose appropriate frequency.
5. Push the **ENTER** knob. The display now looks something like the illustration below.

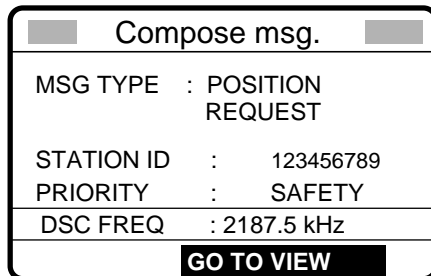

6. Press the **CALL** key to send the message (transmission time: about seven seconds). The following display appears.

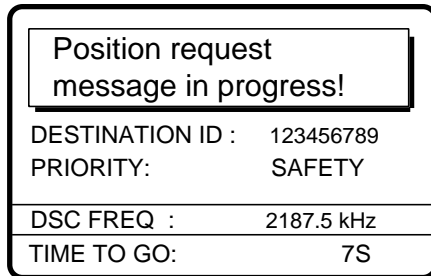

After the call has been sent, the following display appears.

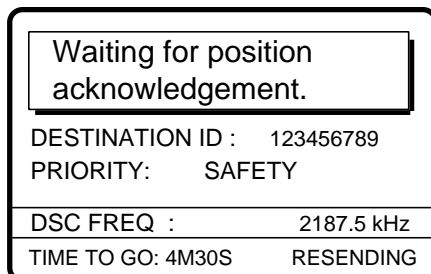

5. ROUTINE MESSAGE CALLING, RECEIVING

One of the following messages appears. “No response! Try calling again?” appears after the time has counted down to zero, meaning there was no response from the party called.

Position acknowledge message received.	
CANCEL: STOP ALARM	
PRIORITY:	SAFETY
POS :	12 34.0000N 123 45.0000E AT 12:34

Position acknowledge message received

No response! Try calling again?	
DESTINATION ID:	123456789
PRIORITY:	SAFETY
DSC FREQ :	2187.5 KHZ
RESEND	

No response

7. Do one of the following depending on the message displayed at step 6.

Acknowledge message received

1. Press the **CANCEL** key to silence the alarm. The display looks as below.

Received message	
MAR-23-2006-23:59	
<u>POSITION ACKNOWLEDGE</u>	
SENDER ID :	123456789
PRIORITY:	SAFETY
POS :	12 34N 123 45E AT 12:34 10M10S
GO TO VIEW	

2. You can now confirm position of other ship.

No response! Try calling again?

Re-send call: Push the **ENTER** knob followed by the **CALL** key.

Cancel call: Press the **CANCEL** key.

5.7.2 Position call: other ship requests your position

You may turn automatic acknowledge of position request on with “POSITION MESSAGE: On” on the Auto Ack menu. For further details, see section 6.11.

Automatic reply

When another ship requests your position and the status of the **5/ ACK/SQ** key is AUTO ACK and the setting of POSITION MESSAGE on the Auto ack menu is ON, the equipment transmits own position data (transmission time: approx. 7 sec.), showing the display below.

Position acknowledge message in progress!	
DESTINATION ID :	123456789
PRIORITY:	SAFETY
POS:	35°30N 135°30E AT 23:54
DSC FREQ :	2187.5 kHz
TIME TO GO :	7S

After the call is sent the audio alarm sounds and the display below appears.



1. Press the **CANCEL** key to silence the alarm, and the display changes as below.

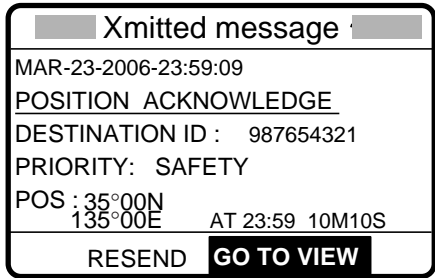

2. Press the **CANCEL** key to return to the radiotelephone screen.

Manual reply

When a position request message is received and the status of the **5/ ACK/SQ** key is MANUAL ACK (or AUTO ACK and POSITION MESSAGE on AUTO ACK menu is OFF), the audio alarm sounds and the display changes as below.

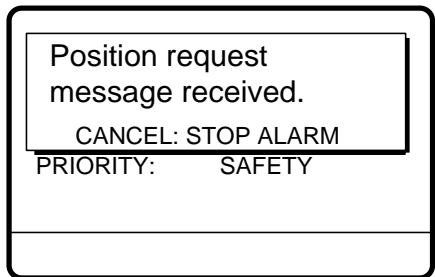

1. Press the **CANCEL** key to silence the alarm. The display changes as below.



2. If canceling to send the reply, press the **CANCEL** key.

5. ROUTINE MESSAGE CALLING, RECEIVING

3. Rotate the **ENTER** knob to choose ANSWER and then push the **ENTER** knob. Your display should now look something like the one below.

Compose msg.	
MSG TYPE: POSITION ACKNOWLEDGEMENT	
POS:	35°00 N 135°00 E AT 23:01
DSC FREQ : 2187.5 kHz	
GO TO VIEW	

4. Confirm the position shown and then press the **CALL** to send the position data (transmission time: approx. 7 sec.). The display changes as below.

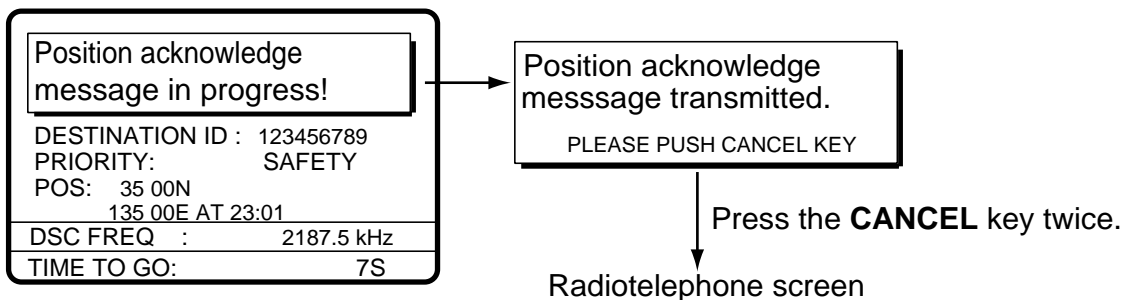

5.8 PSTN Call

The PSTN call allows the making and receiving of telephone calls over public switched telephone networks. To use the PSTN call feature, use a handset which has a HOOK ON/OFF function. The standard supply handset has this feature.

5.8.1 Sending a PSTN call, receiving acknowledge back (ACK BQ)

1. Press the **2/DSC** key.

Select Message	
GENERAL	DISTRESS
INDIVIDUAL	RELAY AREA
PSTN MESSAGE	RELAY COAST
TEST MESSAGE	DISTRESS
GROUP MESSAGE	
AREA MESSAGE	SPECIAL
POSITION	
MMSI 123456789	
POS 12 34.5678N	UTC 01:53
123 45.6789E	MAN 01:54

2. Rotate the **ENTER** knob to choose PSTN MESSAGE and then push the **ENTER** knob.

- Push the **ENTER** knob to open the COAST ID menu, and then rotate the **ENTER** knob to choose MANUAL or SELECT. **For SELECT**, you can choose an ID from the message file list stored. **For MANUAL**, key in ID of coast station (seven digits) with the numeric keys and then push the **ENTER** knob.

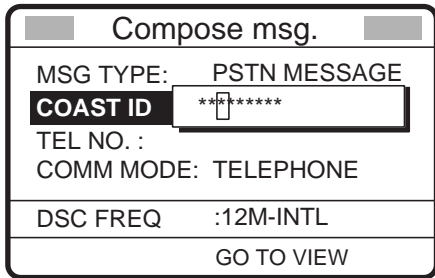

- Push the **ENTER** knob to open the TEL NO. menu.

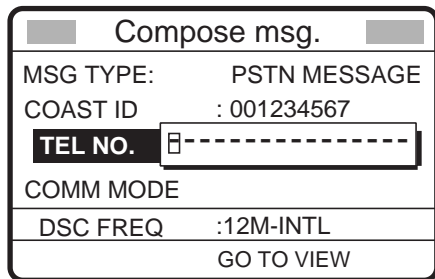

- Enter telephone no. (up to 16 digits) with the numeric keys and then push the **ENTER** knob.
- Push the **ENTER** knob to open the COMM MODE menu, and then choose the communication mode.
- Push the **ENTER** knob.
- Push the **ENTER** knob to open the DSC FREQ menu.

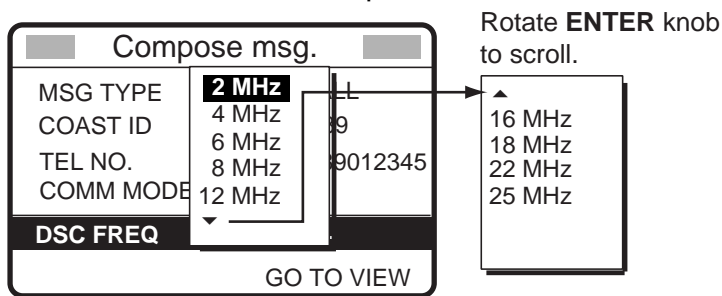

- Rotate the **ENTER** knob to choose DSC band desired and then push the **ENTER** knob to open the DSC FREQ menu.
- Rotate the **ENTER** knob to choose DSC frequency desired and then push the **ENTER** knob. The display changes as below.

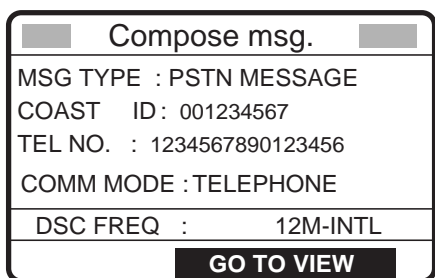

5. ROUTINE MESSAGE CALLING, RECEIVING

11. Press the CALL key to send the PSTN call (transmission time: about seven seconds).
The display shows the following message.

PSTN request message in progress!	
DESTINATION ID :	001234567
TEL NO. :	1234567890123456
DSC FREQ :	12577.5 kHz
TIME TO GO:	7S

One of the following three displays appears. (“No response! Try calling again?” appears after timer counts down to zero and it means there was no response from the coast station.)

Waiting for acknowledgement.	
DESTINATION ID :	001234567
TEL NO. :	1234567890123456
DSC FREQ :	12577.5 kHz
TIME TO GO: 25S	RESENDING

Unable acknowledge message received.	
CANCEL: STOP ALARM	
SENDER ID :	001234567
TEL NO. :	1234567890123456

No response! Try calling again?	
DESTINATION ID :	001234567
TEL NO. :	1234567890123456
DSC FREQ :	12577.5 kHz
RESEND	

12. Do one of the following depending on the message shown in step 11.

Waiting for acknowledgement

If the PSTN call is accepted, the PSTN connection call is sent (transmission time: about seven seconds), showing the display below.

PSTN connection message in progress!	
DESTINATION ID :	001234567
TEL NO. :	1234567890123456
TELEPHONE:	2222.2kHz
DSC FREQ :	12577.5 KHZ
TIME TO GO:	7S

After the call is sent the following messages appears.

Waiting for acknowledgement.	
SENDER ID :	001234567
TEL NO. :	1234567890123456
TELEPHONE:	2222.2kHz
DSC FREQ :	12577.5 KHZ
TIME TO GO: 25S	RESENDING

Then, one of the following displays appears.

PSTN connected.	
DESTINATION :	001234567
TEL NO. :	1234567890123456
TELEPHONE:	2222.2kHz
DSC FREQ :	12577.5 KHZ

PSTN call connected

PSTN end of message in progress!	
DESTINATION :	001234567
TEL NO. :	1234567890123456
DSC FREQ :	12577.5 KHZ
TIME TO GO:	8S

PSTN end of call

13. Follow the instructions below depending on the message shown in 3) above.

PSTN connected: Your phone rings; pick up the handset and communicate with the party you called.

PSTN end of message in progress: The channel could not be used. Press the **CANCEL** key to return to the DSC standby screen.

Unable acknowledge message received

1. The audio alarm sounds; press the **CANCEL** key or **ENTER** knob to silence the alarm. The display shown below appears.

Received message	
MAR-23-2006-23:01	
<u>UNABLE ACKNOWLEDGE</u>	
BUSY	
SENDER ID :	001234567
TEL NO. :	1234567890123456
	10M10S
GO TO VIEW	

2. Press the **CANCEL** key to return to the DSC standby screen.
3. Try the call again later.

No response! Try calling again?

Re-send call: Push the **ENTER** knob followed by the **CALL** key.

Cancel call: Press the **CANCEL** key to return to the radiotelephone screen.

5.8.2 Receiving a PSTN call, sending acknowledge back (ACK BQ)

The following display appears when a PSTN call is received when automatic acknowledge is turned on.

Able acknowledge message in progress!	
DESTINATION ID :	001234567
TEL NO. :	1234567890123456
DSC FREQ :	4208.0 KHZ
TIME TO GO:	8S

5. ROUTINE MESSAGE CALLING, RECEIVING

The timer counts down to zero and then the following display appears.

Pick up the handset or press CALL key.	
DESTINATION ID :	001234567
TEL NO. :	1234567890123456
TELEPHONE:	2222.2kHz
DSC FREQ :	4208.0 KHZ
TIME TO GO:	60S RESENDING

1. Pick up the handset or press the **CALL** key within one minute.

PSTN connection message in progress!	
DESTINATION ID :	001234567
TEL NO. :	1234567890123456
TELEPHONE:	2222.2kHz
DSC FREQ :	4208.0 KHZ
TIME TO GO:	7S

The timer counts down to zero and then the following display appears.

Waiting for acknowledgement.	
SENDER ID :	001234567
TEL NO. :	1234567890123456
TELEPHONE:	2222.2kHz
DSC FREQ :	2222.2 KHZ
TIME TO GO:	25S RESENDING

Shortly thereafter, one of the following messages appears.

PSTN connected.	
DESTINATION ID :	001234567
TEL NO. :	1234567890123456
TELEPHONE :	2222.2 kHz
DSC FREQ :	4208.0KHZ

PSTN call connected

PSTN end of message in progress!	
DESTINATION ID :	001234567
TEL NO. :	1234567890123456
DSC FREQ :	4208.0KHZ
TIME TO GO:	7S

PSTN end of call

2. Do one of the following depending on the message shown at step 5. Note that volume can be adjusted in this condition. Rotate the **PWR/VOL** knob.

PSTN connected: Communicate with party.

PSTN end of message in progress!: The channel could not be used. Press the **CANCEL** key to return to the DSC standby screen.

5.8.3 PSTN call disconnection, receiving charge information (ship disconnects line)

1. After hanging up the handset or pressing the **CANCEL** key to complete your call, the display shows the following message.

PSTN end of message in progress!	
DESTINATION ID : 001234567	
TEL NO. : 1234567890123456	
DSC FREQ :	12577.5 KHZ
TIME TO GO:	8S

After the call is sent, the following messages appears.

Waiting for charge information.	
DESTINATION ID :001234567	
TEL NO. : 1234567890123456	
DSC FREQ :	12577.5 KHZ
TIME TO GO: 20S	RESENDING

When the timer counts down to zero one of the following displays appear.

Charge information message received.	
CANCEL: STOP ALARM	
TEL NO. : 1234567890123456	

No response! charge information.	
DESTINATION ID :001234567	
TEL NO. : 1234567890123456	
DSC FREQ:	xxxx.xkHz

For “**No response! Charge information.**”, the equipment reverts to step 2 in this procedure to await charge information.

2. For “**Charge information message received.**”, the audio alarm sounds; press the **CANCEL** key or **ENTER** knob to silence the audio alarm. The display shown below appears.

Received message	
MAR-23-2006-23:59	
CHARGE INFORMATION	
CHARGE TIME : 00H 12M 34S	
SENDER ID : 001234567	
TEL NO. : 1234567890123456	
10M10S	
GO TO VIEW	

5.8.4 PSTN call disconnection, receiving charge information (coast station disconnects line)

The PSTN line is disconnected by the coast station when it finds no evidence of communications or the land subscriber hangs up. The coast station then sends charge information as below.

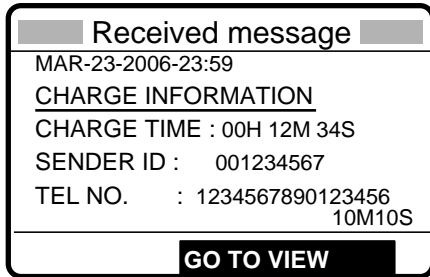

For no charge information the display looks as below.

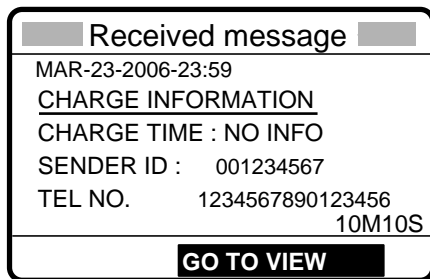

5.9 Log File

Three log files are provided for storage of calls: received ordinary log, received distress log and transmitted log. Each log file stores 50 calls. The latest call is saved as log no.1 and the log no. of all previous calls in that log increments by one. When the storage capacity is exceeded, the oldest call is deleted to make room for the latest. An asterisk (*) marks unread or unacknowledged calls. Received distress calls are automatically deleted 48 hours after being read.

5.9.1 Opening a log file

The procedure for opening a log is common to all logs. The example below shows how to open the received distress log.

1. Press the **LOG/TUNE** key momentary to open the Log file menu.

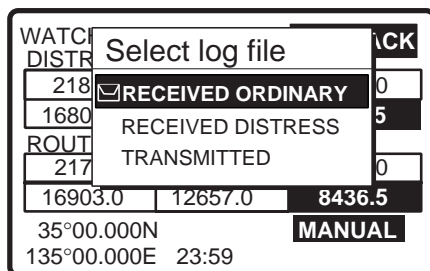

2. Rotate the **ENTER** knob to choose desired log and push the **ENTER** knob. For example, choose the RECEIVED DISTRESS log and then push the **ENTER** knob.
3. Rotate the **ENTER** knob to scroll the log. Asterisk indicates unread message.

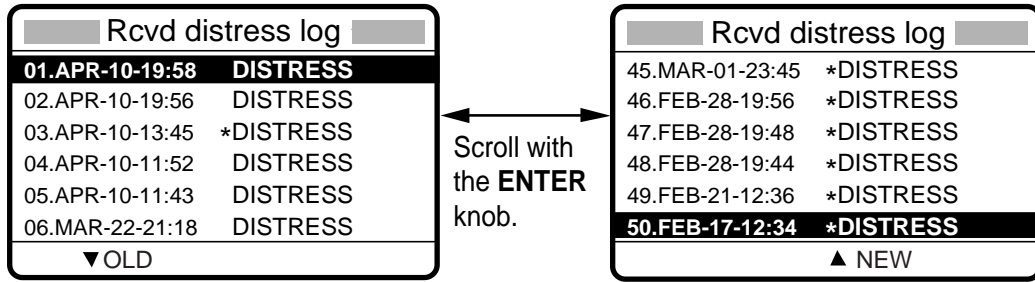

4. **To view the contents of a file, do the following:**

- a) Rotate the **ENTER** knob to choose the file desired and then push the **ENTER** knob.



- b) **DETAIL** is selected; push the **ENTER** knob.



5. **To scroll the log up and down**, use the **FILE/CURSOR** and **#/SETUP** keys, respectively. Use **FILE/CURSOR** key to scroll forward; the **#/SETUP** to scroll backward.
6. **To print all files in the log selected**, press the **8/PRINT** key.
7. **To reply to an unanswered call**, rotate the **ENTER** knob to choose ANSWER, press the **ENTER** knob, and then press the **CALL** key.
8. **To return to the log selected**, press the **CANCEL** key.

5.9.2 Deleting log files

1. Do steps 1-3 and 4a) in the previous procedure to choose the file you wish to delete.
2. Rotate the **ENTER** knob to choose DELETE and then press the **ENTER** knob.

The log files are renumbered to reflect the deletion.

5. ROUTINE MESSAGE CALLING, RECEIVING

This page is intentionally left blank.

6. MENU OPERATION

The menu, consisting of main menus, provides access to less-often used function. It can be accessed from both the RT and DSC screens.

1. Press the **#/SETUP** key to show the main menu.

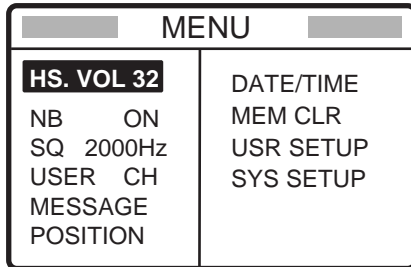

2. Rotate the **ENTER** knob to choose USR SETUP, and press the **ENTER** knob to show the Setup menu.

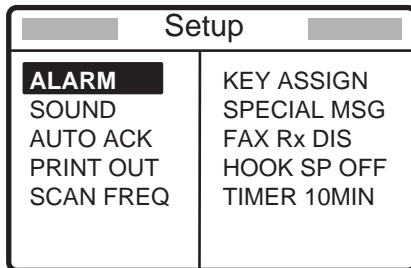

6.1 Adjusting Handset Volume

Adjust handset volume from the HANDSET VOLUME window as follows:

1. Press the **#/SETUP** key.
2. Choose HS. VOL and then push the **ENTER** knob to display the HANDSET VOLUME window.
3. Rotate the **ENTER** knob to adjust volume, and then push the **ENTER** knob.

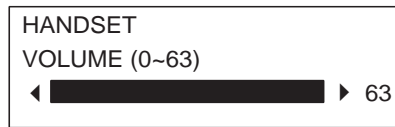

4. Press the **CANCEL** key.

6.2 Noise Blanker

The noise blanker functions to remove pulse noise. You may turn it on or off as follows. Normally, use it with OFF (default setting).

1. Press the **SETUP** key.
2. Rotate the **ENTER** knob to choose NB.
3. Push the **ENTER** knob.
4. Rotate the **ENTER** knob to choose ON or OFF as appropriate, and then push the **ENTER** knob.
5. Press the **CANCEL** key.

“NB” appears in the equipment states area when choosing ON at step 4.

6.3 Squelch Frequency

If you change the squelch frequency (ex. For high voice), do the following procedure. (default setting: 800Hz)

1. Press the **#/SETUP** key.
2. Rotate the **ENTER** knob to choose SQ.
3. Push the **ENTER** knob.
4. Enter frequency (range: 500-2000 Hz) with the numeric keys and then push the **ENTER** knob.
5. Press the **CANCEL** key.

6.4 User Channels

The USER CH menu allows registration and deleting of user TX and RX channels, where permitted by the Authorities. Maximum 256 channels can be registered.

NOTICE
FURUNO will assume no responsibility for the disturbance caused by the unlawful or improper setting of user channels.

6.4.1 Registering user channels

1. Press the **#/SETUP** key.
2. Rotate the **ENTER** knob to choose USER CH and then push the **ENTER** knob.

User ch entry		
MODE: SSB	CH: 2-01	
00201.	TX: 2111.5	RX: 2111.5
00202.	TX: 2222.0	RX: 2222.0
00203.	TX: 2333.5	RX: 2333.5
00204.	TX: 2444.0	RX: 2444.0
00205.	TX: 2555.5	RX: 2555.5

3. Push the **ENTER** knob to open the user channel options window.

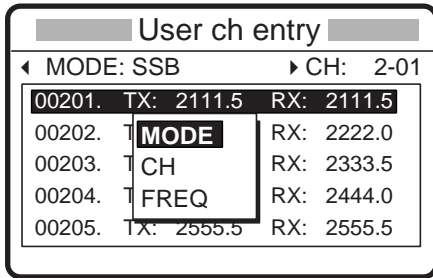

4. Rotate the **ENTER** knob to choose MODE and then push the **ENTER** knob.

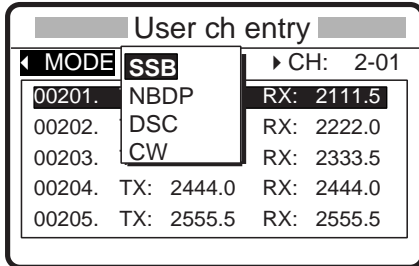

5. Rotate the **ENTER** knob to choose appropriate mode among SSB, NBDP and DSC and then push the **ENTER** knob.

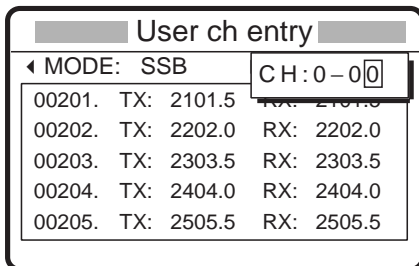

- 256 channels may be registered.
- Band no. setting range is 1-29 and band channel no. range is 01-99.
- For DSC, four channels can be registered per band (2, 4, 6, 8, 12, 16, 18, 22, 25).

6. Key in channel no. and then push the **ENTER** knob. For example, press **0, 1, 2, 3, 4** and then push the **ENTER** knob to enter channel 01234.

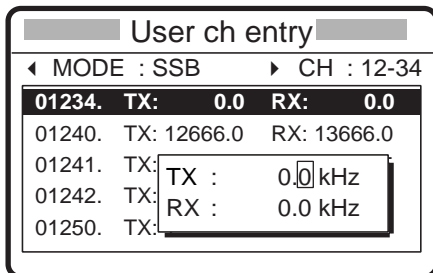

7. Enter TX frequency with the numeric keys.
8. Rotate the **ENTER** knob to choose RX.
9. Enter RX frequency with the numeric keys and then push the **ENTER** knob.
10. Rotate the **ENTER** knob to display all channels entered.
11. Press the **CANCEL** key twice.

6.4.2 Deleting user channels

Deleting individual user channels

1. Press the **#/SETUP** key.
2. Rotate the **ENTER** knob to choose USER CH and then push the **ENTER** knob twice.
3. Rotate the **ENTER** knob to choose CH and then push the **ENTER** knob.
4. Key in the channel number to be deleted, and then push the **ENTER** knob.
5. Tx and Rx frequencies are shown as "0.0 kHz"; push the **ENTER** knob to delete channel.
6. Press the **CANCEL** key twice to return to the radiotelephone screen.

Deleting all user channels

1. Press the **#/SETUP** key.
2. Rotate the **ENTER** knob to choose MEM CLR and then push the **ENTER** knob.
3. Rotate the **ENTER** knob to choose USER CHANNELS and then push the **ENTER** knob.
4. Rotate the **ENTER** knob to choose YES and then push the **ENTER** knob.
5. Press the **CANCEL** key twice to return to the radiotelephone screen.

6.5 Preparing TX Message

For the individual, PSTN, Group and Test messages, you can create messages and store them in the memory for future use. You can recall these messages, for editing or sending, with the ***/FILE/CURSOR** key. Maximum 100 messages can be stored into the memory.

6.5.1 Preparing individual calls

1. Press the **#/SETUP** key to open the setup menu.
2. Rotate the **ENTER** knob to choose MESSAGE.
3. Push the **ENTER** knob.
4. Push the **ENTER** knob to open the MSG TYPE menu.

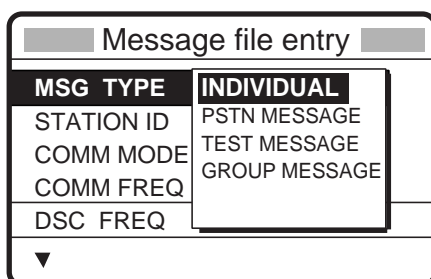

5. Rotate the **ENTER** knob to choose INDIVIDUAL and then push the **ENTER** knob.

6. Push the **ENTER** knob to open the STATION ID entry window.

Message file entry	
MSG TYPE	: INDIVIDUAL
STATION ID	: 000000000
COMM MODE	: TELEPHONE
COMM FREQ	: NO INFO
DSC FREQ	: 2M-INTL
▼	

7. Key in ID of coast station or ship station with the numeric keys and then push the **ENTER** knob.
8. Push the **ENTER** knob to open the COMM MODE window.

Message file entry	
MSG TYPE	: TELEPHONE
STATION ID	: NBDP
COMM MODE	: NBDP-FEC
COMM FREQ	:
DSC FREQ	: 2M-INTL
▼	

9. Rotate the **ENTER** knob to choose communication type desired and then push the **ENTER** knob.
10. Push the **ENTER** knob to open the COMM FREQ window.

Message file entry	
MSG TYPE	: INDIVIDUAL
STATION ID	: 123456780
COMM MODE	: NO INFO
COMM FREQ	: FREQUENCY
DSC FREQ	: CHANNEL
	: POSITION*
▼	

* NO INFO and POSITION appears when coast station ID is entered in the field STATION ID.

11. Rotate the **ENTER** knob to choose appropriate item and then push the **ENTER** knob.
Call to coast station: NO INFO or POSITION.
Call to ship station: FREQUENCY or CHANNEL. Enter appropriate frequency or channel, referring to page 5-3.
12. Push the **ENTER** knob to open the DSC FREQ menu.

Message file entry	
MSG TYPE	: 4 MHz
STATION ID	: 6 MHz
COMM MODE	: 8 MHz
COMM FREQ	: 12 MHz
DSC FREQ	: 2M-INTL
▼	

Rotate **ENTER** knob to scroll.

▲	16 MHz
	18 MHz
	22 MHz
	25 MHz

6. MENU OPERATION

13. Rotate the **ENTER** knob to choose appropriate DSC band and then push the **ENTER** knob.
14. Rotate the **ENTER** knob to choose appropriate DSC frequency and then push the **ENTER** knob.
15. Enter file name and number as shown below.

How to Enter File Name and Number

1. Push the **ENTER** knob to open the file name entry window.

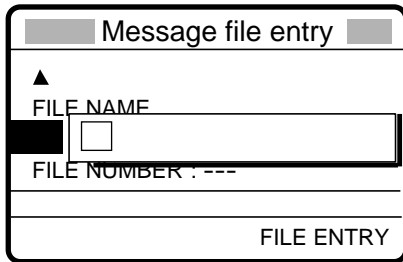

2. Use the numeric keys and **ENTER** knob to enter file name (max. 16 characters). For example, enter FURUNO as the file name.

Key	and available character, symbol
1	: 1→(blank)→1
2	ABC : 2→A→B→C→2
3	DEF : 3→D→E→F→3
4	GHI : 4→G→H→I→4
5	JKL : 5→J→K→L→5
6	MNO : 6→M→N→O→6
7	PQRS : 7→P→Q→R→S→7
8	TUV : 8→T→U→V→8
9	WXYZ : 9→W→X→Y→Z→9
0	: 0→_→-→0

1. Rotate **ENTER** knob to select location.
2. Press appropriate key.

How to enter "FURUNO" as file name

1. Press the **3** key to display F.
2. Rotate **ENTER** knob to shift cursor.
3. Press the **8** key to select U.
4. Rotate **ENTER** knob to shift cursor.
5. Press the **7** key to select R.
6. Rotate **ENTER** knob to shift cursor.
7. Press the **8** key to select U.
8. Rotate **ENTER** knob to shift cursor.
9. Press the **6** key to select N.
10. Rotate **ENTER** knob to shift cursor.
11. Press the **6** key to select O.
12. Push the **ENTER** knob.

3. Push the **ENTER** knob to open the file number entry window. Key in file number in three digits with the numeric keys and then push the **ENTER** knob. For example, press **0, 0, 1, ENTER** knob to enter file number 001.

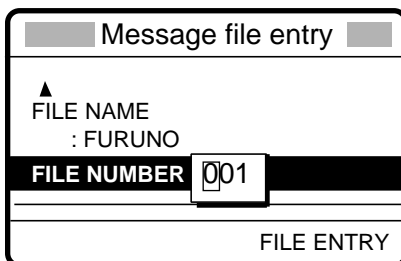

Note: The available file number is 001-799 and 900-999.

4. Push the **ENTER** knob. The display shows the name and file number entered.

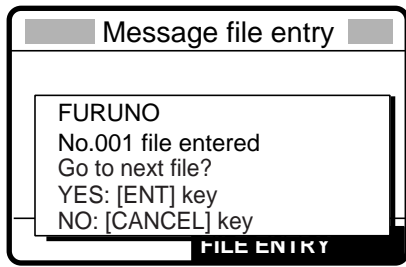

If the file name or number exists the message "Duplicate name (number) ! Overwrite OK?" appears. Push the **ENTER** knob to write over the name, or press the **CANCEL** key to escape.

5. Push the **ENTER** knob to continue

6.5.2 Preparing group calls

To receive the group calls, registering of the group ID is necessary as below.

1. Press the **#/SETUP** key.
2. Rotate the **ENTER** knob to choose MESSAGE.
3. Push the **ENTER** knob.
4. Push the **ENTER** knob to open the MSG TYPE menu.

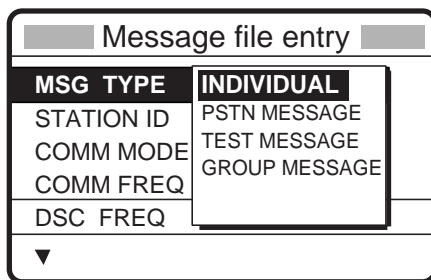

5. Rotate the **ENTER** knob to choose GROUP MESSAGE and then push the **ENTER** knob.
6. Push the **ENTER** knob to open the GROUP ID entry window.

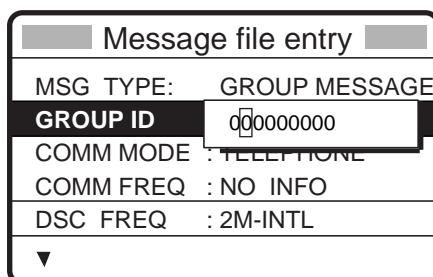

7. Key in ID of group with the numeric keys and then push the **ENTER** knob.

6. MENU OPERATION

8. Push the **ENTER** knob to open the COMM MODE menu.

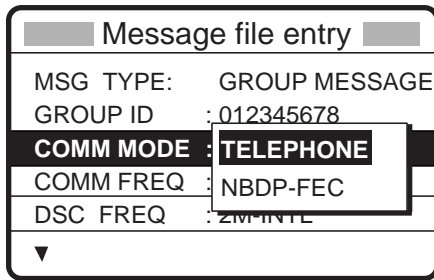

9. Rotate the **ENTER** knob to choose appropriate communications type and then push the **ENTER** knob.

10. Push the **ENTER** knob to open the COMM FREQ menu.

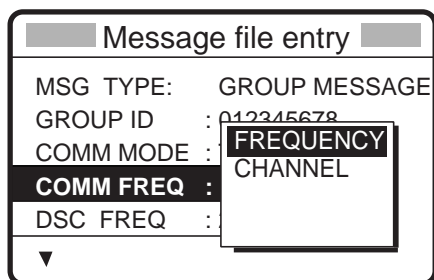

11. Rotate the **ENTER** knob to choose appropriate item and then push the **ENTER** knob.

12. Enter frequency or channel.

13. Push the **ENTER** knob to open the DSC FREQ menu.

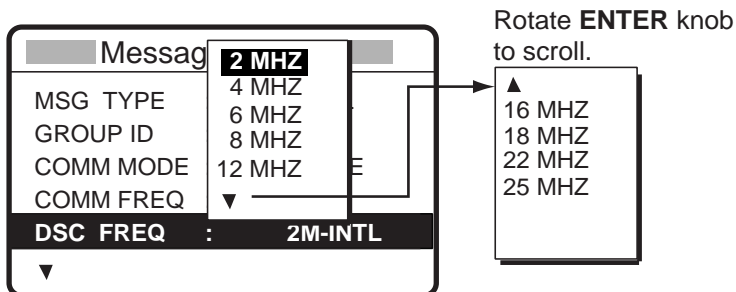

14. Rotate the **ENTER** knob to choose appropriate DSC band and then push the **ENTER** knob.

15. Choose appropriate DSC frequency and then push the **ENTER** knob.

16. Follow "How to Enter File Name and Number" on page 6-6 to enter file name and number.

6.5.3 Preparing PSTN calls

1. Press the **#/SETUP** key.
2. Rotate the **ENTER** knob to choose MESSAGE.
3. Push the **ENTER** knob.
4. Push the **ENTER** knob to open the MSG TYPE menu.

Message file entry	
MSG TYPE	INDIVIDUAL
STATION ID	PSTN MESSAGE
COMM MODE	TEST MESSAGE
COMM FREQ	GROUP MESSAGE
DSC FREQ	
▼	

5. Rotate the **ENTER** knob to choose PSTN MESSAGE and then push the **ENTER** knob.
6. Push the **ENTER** knob to open the COAST ID entry window.

Message file entry	
MSG TYPE	: PSTN MESSAGE
COAST ID	00000000
TEL NO.	: -----
DSC FREQ	: 2M-INTL
▼	

7. Key in ID of coast station (seven digits) with the numeric keys then push the **ENTER** knob.
8. Push the **ENTER** knob to open the TEL. NO. entry window.

Message file entry	
MSG TYPE:	PSTN MESSAGE
COAST ID	: 001234567
TEL NO.	□ -----
DSC FREQ	: 2M-INTL
▼	

9. Key in telephone no. (up to 16 digits) with the numeric keys and then push the **ENTER** knob.
10. Push the **ENTER** knob to open the DSC FREQ menu.

Message file entry	
MSG TYPE:	PSTN MESSAGE
COAST ID	: 001234567
TEL NO. :	□ -----
DSC FREQ	: 2M-INTL TL
▼	

Rotate the **ENTER** knob to scroll.

2 MHZ
4 MHZ
6 MHZ
8 MHZ
12 MHZ
16 MHZ
18 MHZ
22 MHZ
25 MHZ

6. MENU OPERATION

11. Rotate the **ENTER** knob to choose appropriate DSC band and then push the **ENTER** knob.
12. Choose appropriate DSC frequency and then push the **ENTER** knob.
13. Follow "How to Enter File Name and Number" on page 6-6 to enter file name and number.

6.5.4 Preparing test call

1. Press the **#/SETUP** key.
2. Rotate the **ENTER** knob to choose MESSAGE and then push the **ENTER** knob.
3. Push the **ENTER** knob to open the MSG TYPE menu.

Message file entry	
MSG TYPE	INDIVIDUAL
STATION ID	PSTN MESSAGE
COMM MODE	TEST MESSAGE
COMM FREQ	GROUP MESSAGE
DSC FREQ	
▼	

4. Rotate the **ENTER** knob to choose TEST MESSAGE and then push the **ENTER** knob.
5. Push the **ENTER** knob to open the STATION ID entry window.

Message file entry	
MSG TYPE	TEST
STATION ID	00000000
DSC FREQ	2187.5 KHZ
▼	

6. Enter station ID where to send the test message and then push the **ENTER** knob.
7. Push the **ENTER** knob to open the DSC FREQ menu.

Message file entry	
MSG TYPE	2187.5
STATION ID	4207.5
	6312.0
	8414.5
	12577.0
	16804.5
DSC FREQ	KHZ

8. Rotate the **ENTER** knob to choose appropriate DSC frequency and then push the **ENTER** knob.
9. Follow "How to Enter File Name and Number" on page 6-6 to enter file name and number.

6.5.5 Sending prepared messages

Sending without modification

1. Press the **FILE/CURSOR** key at the DSC standby screen to show the send message file list. Below is an example of the send message file list.

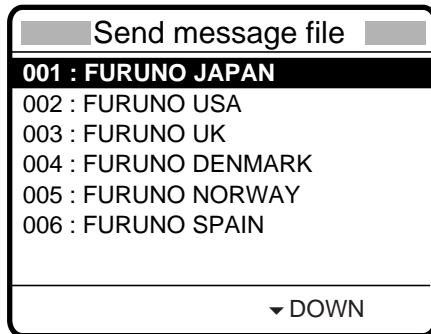

2. Rotate the **ENTER** knob to choose a file.
3. Press the **CALL** key to send the message.

Editing before sending

1. Press the **FILE/CURSOR** key at the DSC standby screen to show the send message file list.
2. Rotate the **ENTER** knob to choose file desired and then push the **ENTER** knob.



3. **DETAIL** is selected; push the **ENTER** knob. The message contents are shown on the "Compose msg." Screen.
4. Edit the message as necessary.
5. Press the **CALL** key to send the message.

6.5.6 Deleting send message

Deleting send messages individually

1. Press the **FILE/CURSOR** key at the DSC standby screen to show the send message file list.
2. Rotate the **ENTER** knob to choose file desired and then push the **ENTER** knob.



3. Rotate the **ENTER** knob to choose **DELETE** and then push the **ENTER** knob.

6. MENU OPERATION

Deleting all messages

1. Press the **#/SETUP** key.
2. Rotate the **ENTER** knob to choose the MEM CLR.
3. Rotate the **ENTER** knob to choose the MESSAGE FILES.
4. Push the **ENTER** knob.
5. Rotate the **ENTER** knob to choose YES.
6. Push the **ENTER** knob.

6.5.7 Printing List of Send Message Files

You can print a list of send message files as follows:

1. Press the **FILE/CURSOR** key to open the Send message file list.
2. Press the **8/PRINT** key.
3. YES is selected; push the **ENTER** knob to print.

```
***** Send message file *****
001. FURUNO JAPAN      INDIVIDUAL MESSAGE
002. FURUNO USA       INDIVIDUAL MESSAGE
003. FURUNO UK        PSTN MESSAGE
004. FURUNO DENMARK   GROUP MESSAGE
005. FURUNO NORWAY    INDIVIDUAL MESSAGE
006. FURUNO SPAIN     GROUP MESSAGE
007. FURUNO FRANCE    INDIVIDUAL MESSAGE
```

Note: Message not framed in actual printout.

6.6 Manual Entry of Position and Time

If there is no EPFS (Electronic Position-Fixing System) connected to this equipment or the EPFS connected is not working (EPFS error indication appears), manually enter position and time as follows:

1. Press the **#/SETUP** key.
2. Rotate the **ENTER** knob to choose POSITION.
3. Push the **ENTER** knob.

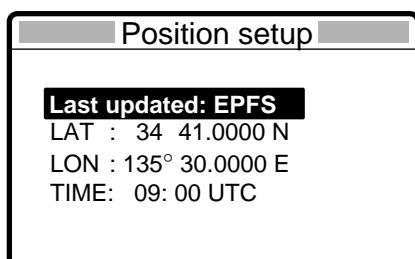

"Last updated" shows the method used at the last time, EPFS, MANUAL or NO INFO (information).

Note: If, when “Last updated” is EPFS, input from the navigator is interrupted, the message “EPFS error” appears. If this occurs, check the navigator.

4. Push the **ENTER** knob to show the position method window, and then rotate the **ENTER** knob to choose the EPFS, MANUAL or NO INFO.
5. Press the **ENTER** knob. Go to step 6 only when choosing MANUAL at step 4.
6. Push the **ENTER** knob to open the latitude input window. Use the numeric keys to enter latitude. If necessary, switch coordinates: **1/RT/CH** key to switch to North; **2/DSC** key to switch to South. Push the **ENTER** knob.

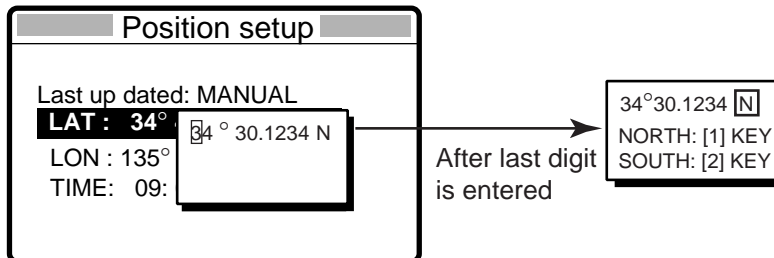

7. Push the **ENTER** knob to open the longitude input window. Use the numeric keys to enter longitude. If necessary, switch coordinates: **1/RT/CH** key to switch to East; **2/DSC** key to switch to West. Push the **ENTER** knob.

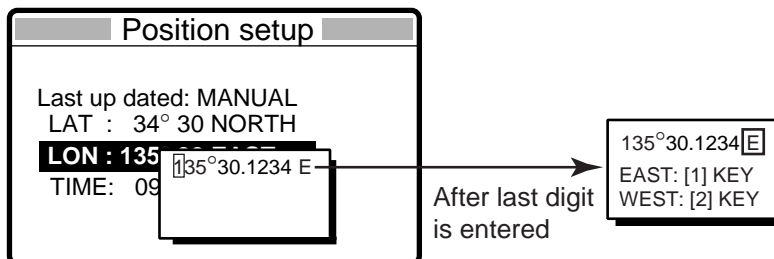

8. Push the **ENTER** knob to open the time input window.

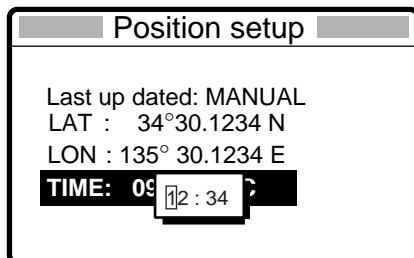

9. Enter UTC time with the numeric keys and then push the **ENTER** knob.
10. Press the **CANCEL** key.

Note: When “Last updated” is MANUAL, the message “Warning: Update position” appears at set intervals (update interval selected with POSITION OLDER on the Alarm menu) to ask you to update position.

6.7 Date and Time Setting

Set the date and time for the system.

1. Press the **#/SETUP** key.
2. Rotate the **ENTER** knob to choose DATE/TIME.
3. Push the **ENTER** knob.

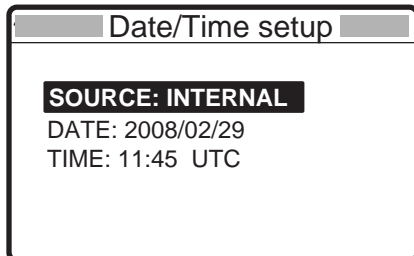

SOURCE: Choose INTERNAL or EPFS (using ZDA).

DATE: Enter the date for manual setting.

TIME: Enter time for manual setting.

4. Choose DATE, and push the **ENTER** knob.
5. Use the numeric keys to enter year/month/date, and push the **ENTER** knob.
6. The cursor chooses TIME; push the **ENTER** knob.
7. Use the numeric keys to enter the time, and push the **ENTER** knob.

6.8 Memory Clear

Logs, messages files and user channels in the memory can be cleared. Also, the settings are able to restore to the default setting.

1. Press the **#/SETUP** key.
2. Rotate the **ENTER** knob to choose MEM CLR.
3. Push the **ENTER** knob.

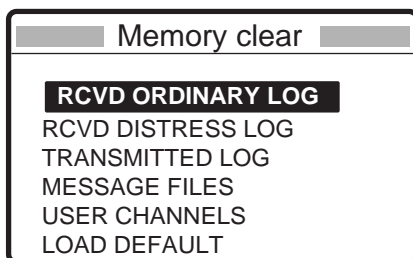

Clearing received ordinary log

1. Rotate the **ENTER** knob to choose RCVD ORDINARY LOG.
2. Push the **ENTER** knob.

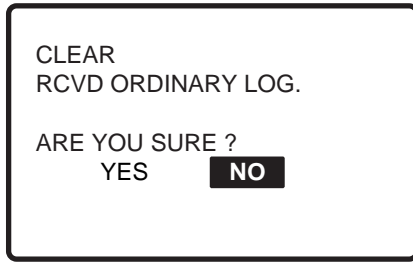

3. Rotate the **ENTER** knob to choose YES, and push the **ENTER** knob.

Clearing received distress log

1. Rotate the **ENTER** knob to choose RCVD DISTRESS LOG.
2. Push the **ENTER** knob.

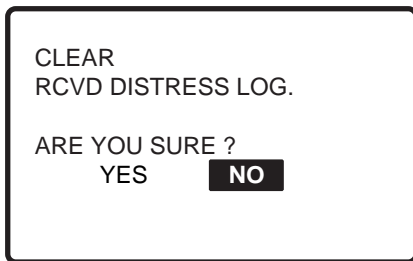

3. Rotate the **ENTER** knob to choose YES, and push the **ENTER** knob.

Clearing transmitted log

1. Rotate the **ENTER** knob to choose TRANSMITTED LOG.
2. Push the **ENTER** knob.

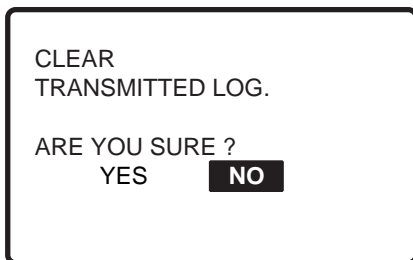

3. Rotate the **ENTER** knob to choose YES, and push the **ENTER** knob.

6. MENU OPERATION

Clearing message files

1. Rotate the **ENTER** knob to choose MESSAGE FILES.
2. Push the **ENTER** knob.

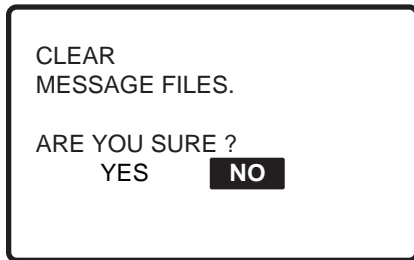

3. Rotate the **ENTER** knob to choose YES, and push the **ENTER** knob.

Clearing user channels

1. Rotate the **ENTER** knob to choose USER CHANNELS.
2. Push the **ENTER** knob.

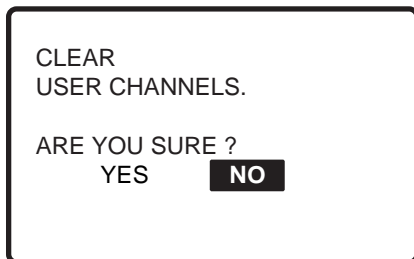

3. Rotate the **ENTER** knob to choose YES, and push the **ENTER** knob.

Restoring to default setting

1. Rotate the **ENTER** knob to choose LOAD DEFAULT.
2. Push the **ENTER** knob.

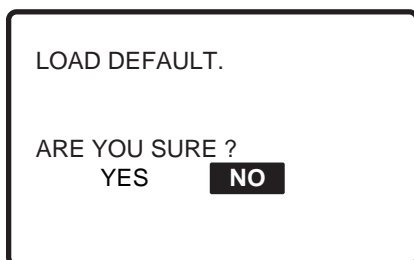

3. Rotate the **ENTER** knob to choose YES, and push the **ENTER** knob.

6.9 Setting Alarms

The Alarm setup menu enables or disables the internal and external alarm beep. Note that the receiving alarm beep for the distress and urgency cannot be disable.

1. Press the **#/SETUP** key.
2. Rotate the **ENTER** knob to choose USR SETUP, and push the **ENTER** knob.
3. Rotate the **ENTER** knob to choose ALARM, and push the **ENTER** knob.

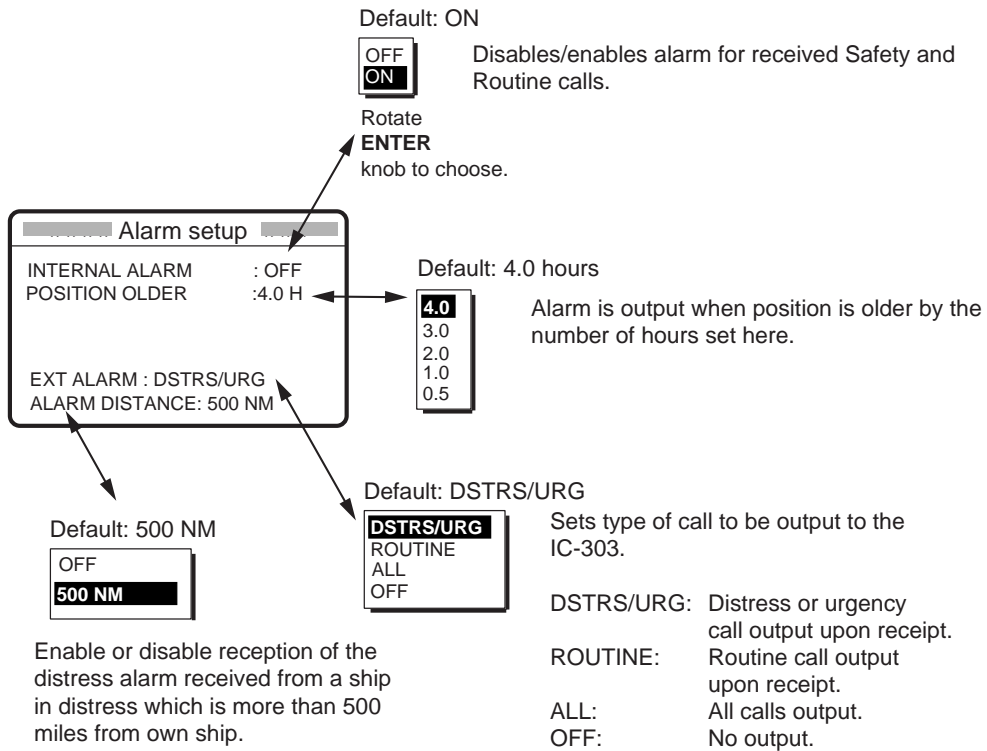

6.10 Sound Setting

The SOUND menu lets you set the volume for the following items:

- Key click on/off
- Volume of the receiving alarm for the safety and routine messages
- Volume of the receiving alarm for the distress and urgency

1. Press the **#/SETUP** key.
2. Rotate the **ENTER** knob to choose USR SETUP, and push the **ENTER** knob.
3. Rotate the **ENTER** knob to choose SOUND, and push the **ENTER** knob.

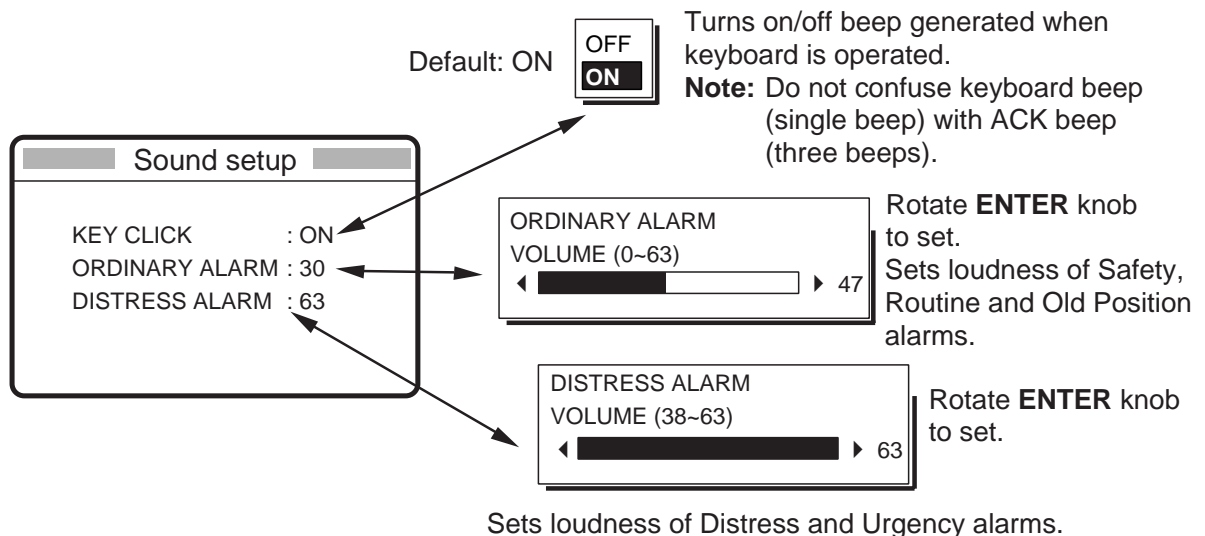

6.11 Setting the AUTO ACK Details

The acknowledgement message may be sent automatically when you receive a message which requires acknowledgement. You can also enable or disable it for position, polling and test messages. Note that the automatic acknowledge is automatically disabled when RX call contains error, as required by law. Further, automatic acknowledge is disabled in case of OFF HOOK.

1. Press the **#/SETUP** key.
2. Choose **USR SETUP**, and push the **ENTER** knob.
3. Rotate the **ENTER** knob to choose **AUTO ACK**, and push the **ENTER** knob.

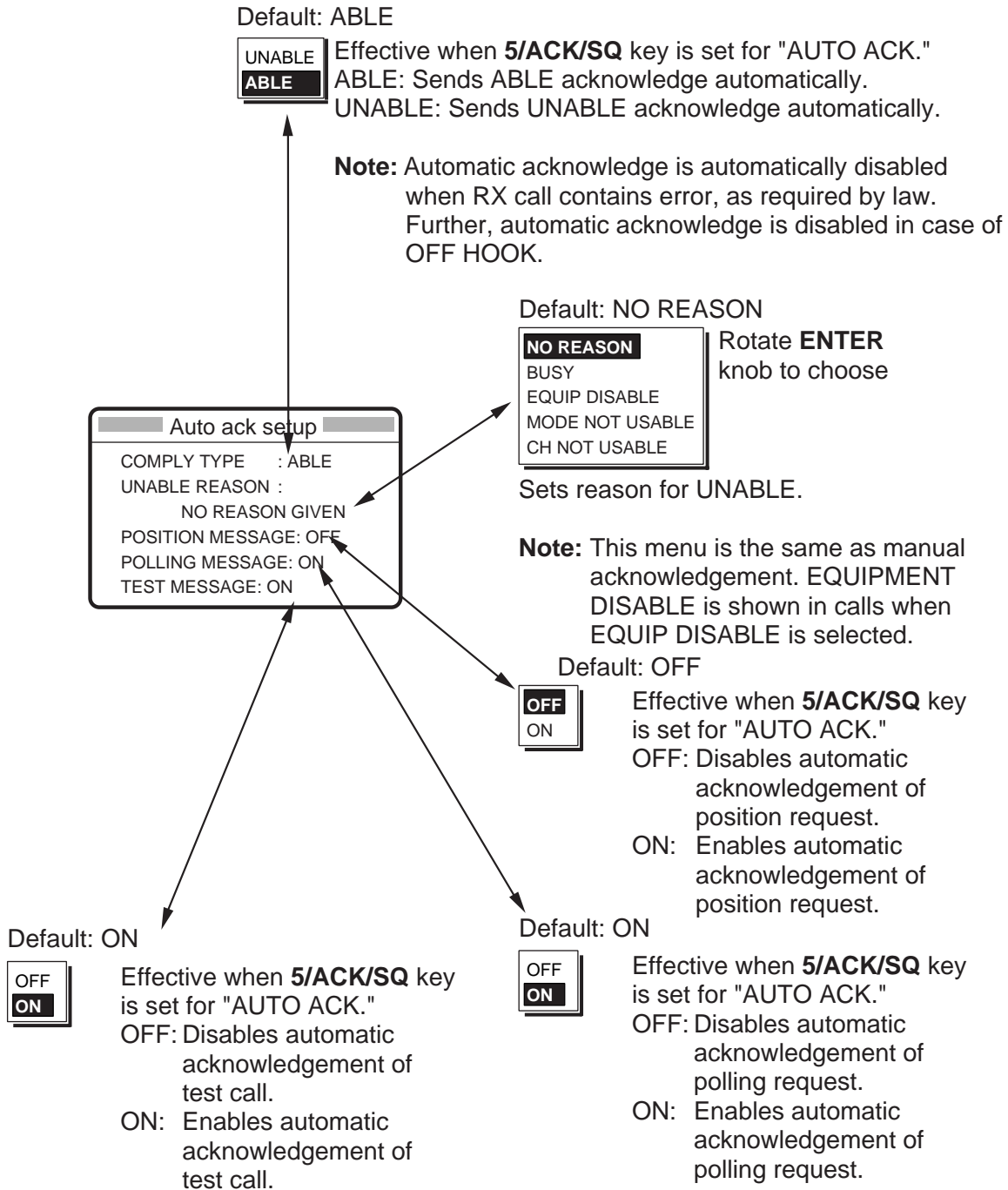

6.12 Printing Messages

The Print Out menu enables/disables automatic printing of all transmitted and received calls and the results of the daily test.

1. Press the **SETUP** key.
2. Choose **USR SETUP** and **PRINT OUT** in order, and push the **ENTER** knob to display the Print out set up menu.

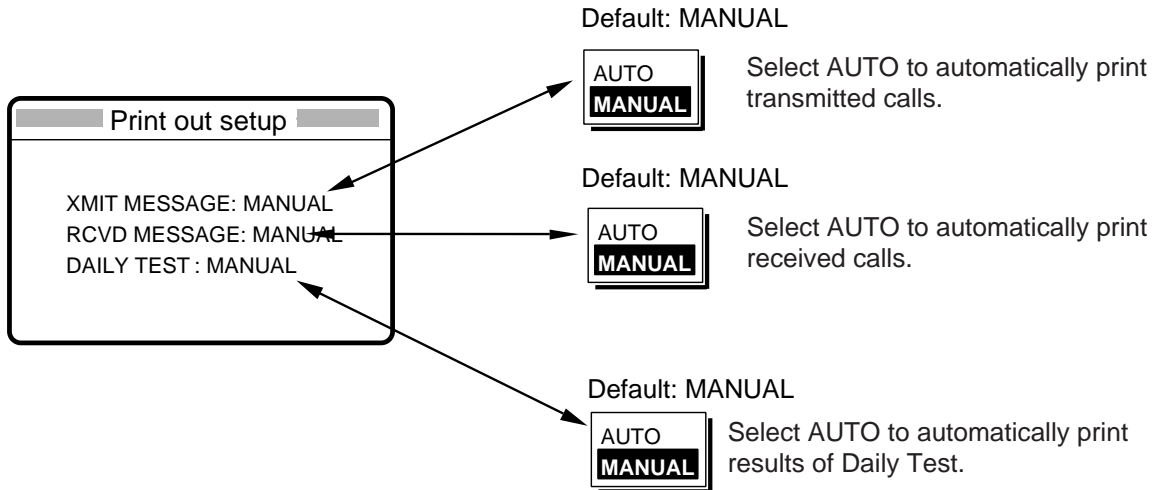

Sample printouts

Printing can be done automatically or manually. For manual printing, press the **PRINT** key. Note that calls having more than one page (for example, received calls) are printed out in their entirety.

```
* Received message at JUN-08-2006-16:10:12 *
DISTRESS ALERT
SELF-IDENTITY      : 77777777
NATURE OF DISTRESS : UNDESIGNATED DISTRESS
DISTRESS COORDINATES : NO INFORMATION
DISTRESS TELECOMMAND : TELEPHONE
END OF SEQUENCE    : EOS
ACKNOWLEDGEMENT REQUIRED
ERROR-CHECK        : OK
DSC FREQUENCY      TX: 2187.5 kHz
                   RX: 2187.5 kHz
```

Sample Received Message Printout (Distress)

```
* Received message at JUN-08-2006-16:10:12 *
INDIVIDUAL REQUEST
DESTINATION ID     : 11111111
PRIORITY           : ROUTINE
SELF-IDENTITY      : 987654321
COMMUNICATION MODE : TELEPHONE
COMMUNICATION OPTION : NO INFORMATION
WORKING FREQUENCY  : NO INFORMATION
ACKNOWLEDGEMENT REQUIRED
ERROR-CHECK        : OK
DSC FREQUENCY      TX: 2177.0 kHz
                   RX: 2177.0 kHz
```

Sample Received Message Printout (Individual)

```
*Transmitted message at JUN-08-2006-16:10:12 *
DISTRESS ALERT
SELF-IDENTITY      : 11111111
NATURE OF DISTRESS : UNDESIGNATED DISTRESS
DISTRESS COORDINATES : NO INFORMATION
COMMUNICATION MODE : TELEPHONE
ACKNOWLEDGEMENT REQUIRED
DSC FREQUENCY      TX: 2177.0 kHz
                   RX: 2177.0 kHz
```

Sample Transmitted Message Printout (Distress)

```
*Transmitted message at JUN-08-2006-16:10:12 *
INDIVIDUAL REQUEST
DESTINATION ID     : 123456789
PRIORITY           : ROUTINE
SELF-IDENTITY      : 11111111
COMMUNICATION MODE : TELEPHONE
COMMUNICATION OPTION : NO INFORMATION
WORKING FREQUENCY  : NO INFORMATION
ACKNOWLEDGEMENT REQUIRED
DSC FREQUENCY      TX: 2177.0 kHz
                   RX: 2177.0 kHz
```

Sample Transmitted Message Printout (Individual)

Note: Messages are not framed in actual printouts.

6.13 Setting Scan Frequencies

The Scan freq menu determines which DSC routine and distress frequencies to scan. Follow the instructions below to select/deselect DSC routine and distress frequencies to scan.

1. Press the **#/SETUP** key.
2. Rotate the **ENTER** knob to choose **USR SETUP**, and push the **ENTER** knob.
3. Rotate the **ENTER** knob to choose **SCAN FREQ**, and then push the **ENTER** knob to display the Scan freq setup menu.

Scan freq setup	
ROUTINE	DISTRESS
F1 : 2M-INTL	2M : FIXED
F2 : 4M-INTL	4M : ON
F3 : 6M-INTL	6M : ON
F4 : 8M-INTL	8M : FIXED
F5 : 12M-INTL	12M : ON
F6 : 16M-INTL	16M : OFF

Distress and safety frequencies

1. Rotate the **ENTER** knob clockwise to shift the cursor to the **DISTRESS** column.
2. Rotate the **ENTER** knob to choose the frequency band and then push the **ENTER** knob.
For example, choose 4 MHz.

Scan freq setup	
ROUTINE	DISTRESS
F1 : 2M-INTL	2M : OFF
F2 : 2M-INTL	4M : ON
F3 : 4M-INTL	6M : ON
F4 : 8M-INTL	8M : FIXED
F5 : 12M-INTL	12M : ON
F6 : 16M-INTL	16M : OFF

3. Rotate the **ENTER** knob to choose **ON** or **OFF** as appropriate and then push the **ENTER** knob.
4. Press the **CANCEL** key three times to return to the radiotelephone screen.

Note: Regulations require that 2 MHz and 8 MHz and one more DSC distress frequency be watched continuously. 2 MHz and 8 MHz cannot be turned off. Maximum three bands may be turned off.

Routine frequencies

1. Rotate the **ENTER** knob clockwise to shift the cursor to the ROUTINE column.

Scan freq setup	
ROUTINE	DISTRESS
F1 : 2M-INTL	2M : FIXED
F2 : 4M-INTL	4M : ON
F3 : 6M-INTL	6M : ON
F4 : 8M-INTL	8M : FIXED
F5 : 12M-INTL	12M : ON
F6 : 16M-INTL	16M : OFF

2. Rotate the **ENTER** knob to choose the frequency band. For example, choose F1.

Scan freq setup	
ROUTINE	DISTRESS
OFF	2M : FIXED
F1 : 2 MHZ	4M : ON
F2 : 4 MHZ	6M : ON
F3 : 6 MHZ	8M : FIXED
F4 : 8 MHZ	12M : ON
F5 : 12 MHZ	16M : OFF
F6 : 16 MHZ	

3. Rotate the **ENTER** knob to choose a frequency to set.
4. Push the **ENTER** knob, and the display looks something like the one below.

Scan freq setup	
ROUTINE	DISTRESS
F1 INTL : T 2189.5/R 2177.0	
DIST : T2187.5/R 2187.5	
F2 : 2M-INTL	2M : OFF
F3 : 4M-INTL	4M : ON
F4 : 6M-INTL	6M : ON
F5 : 8M-INTL	8M : FIXED
F6 : 12M-INTL	12M : ON
F7 : 16M-INTL	16M : OFF

← User channel appears if registered.

5. Rotate the **ENTER** knob to choose frequency desired and then push the **ENTER** knob.
 - INTL: International channels
 - DIST: Distress channels
 - LOCAL1/LOCAL2: Local channels
 - USER: User channel
6. Press the **CANCEL** key three times to return to the radiotelephone screen.

Note: Distress frequencies can be stored on the routine frequency memory. This is convenient for backing up the watch-keeping receiver.

6.14 Key Assignment

The **8/PRINT** key can function as a short-key, providing quick access to a function without opening the menu. You can program one of the functions listed below, and the default setting is NONE (shortcut function is disabled).

- NONE: Not assigned any function.
- NB: Noise blanker on/off
- TONE: Transmit/stop the tone signal.
- SDUP/DUP: Changes the communication mode on the duplex channel (FS-5070 only)

1. Press the **#/SETUP** key.
2. Rotate the **ENTER** knob to choose USR SETUP, and push the **ENTER** knob.
3. Rotate the **ENTER** knob to choose KEY ASSIGN, and push the **ENTER** knob.

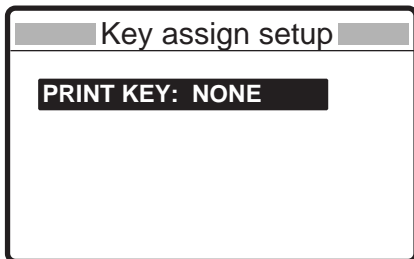

4. Push the **ENTER** knob.
5. Rotate the **ENTER** knob to choose NONE, NB, TONE or SDUP/DUP as appropriate.
6. Push the **ENTER** knob.

6.15 Special Messages

Permission to transmit NEWTRAL CRAFT and MEDICAL TRANSPORT can be enabled or disabled as follows:

1. Press the **#/SETUP** key.
2. Rotate the **ENTER** knob to choose USR SETUP, and push the **ENTER** knob.
3. Rotate the **ENTER** knob to choose SPECIAL MSG, and push the **ENTER** knob to show the following menu.

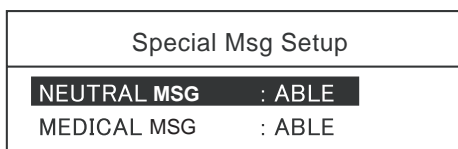

4. Choose NEUTRAL MSG or MEDICAL MSG, and then push the **ENTER** knob.



5. Choose ABLE or UNABLE as appropriate, and then push the **ENTER** knob.
6. Press the **CANCEL** key to return to the radiotelephone screen.

6.16 FAX Enable/Disable

You may enable or disable FAX use as follows. This setting is necessary when the facsimile is connected and used to receive.

1. Press the **#/SETUP** key.
2. Rotate the **ENTER** knob to choose USR SETUP, and then push the **ENTER** knob.
3. Rotate the **ENTER** knob to choose FAX Rx and then push the **ENTER** knob.
4. Rotate the **ENTER** knob to choose ENABLE or DISABLE as appropriate and then push the **ENTER** knob.

When choosing ENABLE, "FAX" is added to the emission mode.

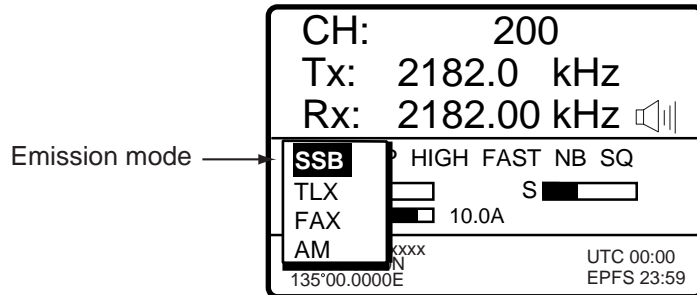

5. Press the **CANCEL** key twice return to the radiotelephone screen.

6.17 Speaker Setting in Off Hook

When the handset is off hook, you may choose to turn the speaker (panel speaker or external speaker) on or off. The default setting is OFF, which turns off the speaker when the handset is off hook. The ON position keeps the speaker on always, regardless of handset state.

1. Press the **#/SETUP** key.
2. Rotate the **ENTER** knob to choose USR SETUP and push the **ENTER** knob.
3. Rotate the **ENTER** knob to choose HOOK SP OFF, push the **ENTER** knob.
4. Rotate the **ENTER** knob to choose ON or OFF as appropriate, and push the **ENTER** key.

6.18 Operation Timer Off

When the screen which cannot receive the DSC message is active more than 10 minutes without any operation, the control unit returns to the radiotelephone screen automatically. You can enable/disable this function as below:

1. Press the **#/SETUP** key.
2. Rotate the **ENTER** knob to choose USR SETUP and push the **ENTER** knob.
3. Rotate the **ENTER** knob to choose TIMER, push the **ENTER** knob.
4. Rotate the **ENTER** knob to choose 10MIN or OFF as appropriate, and push the **ENTER** knob.

6. MENU OPERATION

This page is intentionally left blank.

7. NBDP SYSTEM OVERVIEW

7.1 Turning on the NBDP System

Turn on the terminal unit and the printer with their respective power switches.

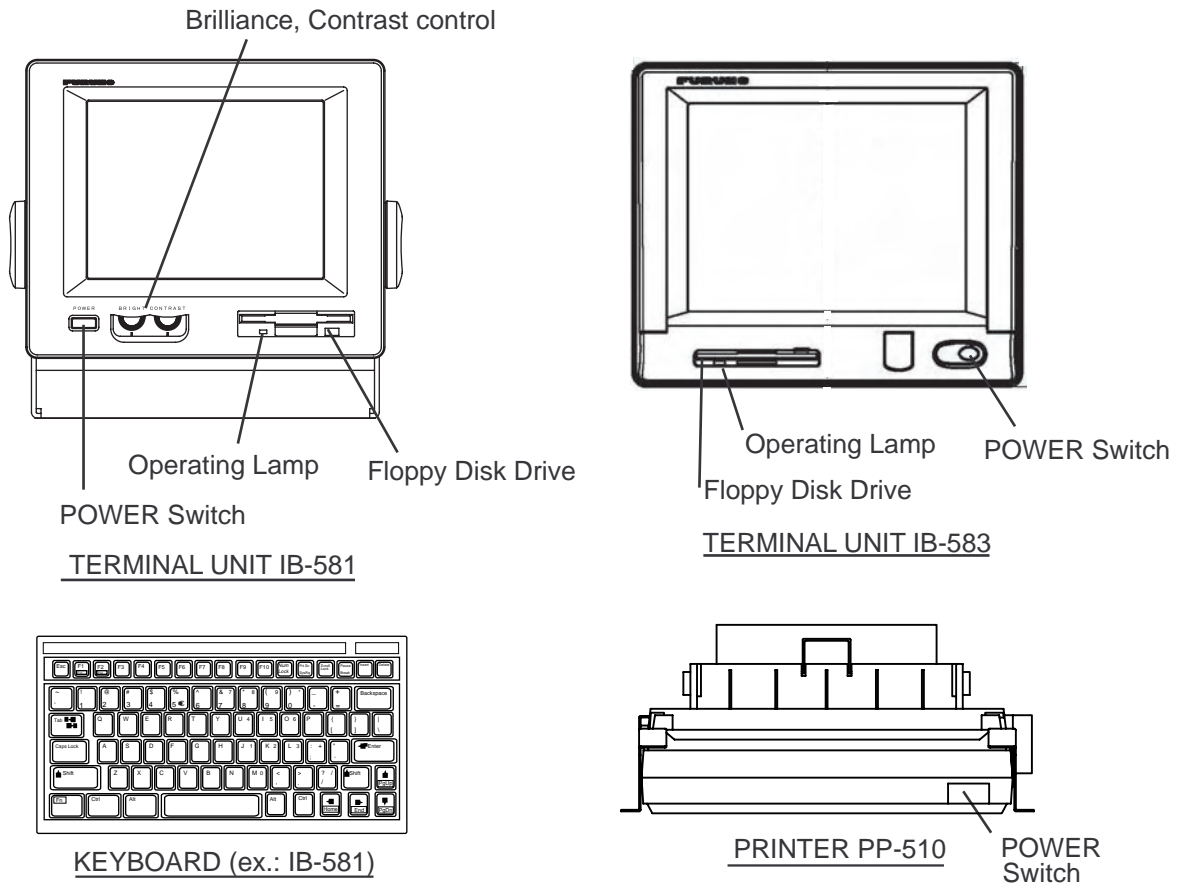

NBDP terminal unit, printer and keyboard

Note 1: To power the system, turn on the control unit then turn on the NBDP terminal unit.

Note 2: The Printer PP-510 prints messages. Refer to its operator's manual for operating information.

Note 3: When the NBDP has priority, the control unit displays "OCCUPIED (NBDP)".

Note 4: The name for the Insert and Delete keys is different depending on the Terminal Unit (keyboard) used. They are Insert and Delete on IB-581 and Ins and Del on IB-583. This manual shows Insert, Delete.

7.2 Description of Equipment

7.2.1 Terminal unit

The terminal unit is a visual display incorporating a floppy disk drive, which provides for storage of files on floppy disks. Two models are available, IB-581 (monochrome) and IB-583 (color). Controls for power and adjustment of display brilliance and contrast are provided on the front panel of the IB-581. To adjust the brilliance on the IB-583, press **Alt** while pressing **F6** to lower the brilliance; **F7** to raise it. (The IB-583 does not have a control for adjustment of contrast.) Eight levels of brilliance are available.

When the terminal unit is turned on, the communication status display, shown below, appears. This is where all phases of telex communications begin.

```

1:File 2:Edit 3:Operate 4:Window 5:Station 6:System 7:WRU 8:HR 9:Over 10:Break
----- 2002-10-15 2:26:45 UTC -----Caps-Eng
Station Name      :
Frequency (T/R)  :      . /      . (kHz)  Comm Mode : AUTO
Comm Status      :  Connect Send Lock Error
Sending Volume   :      (%)   ARQ Error : 0   ARQ Time : 0(sec)
-----

```

Communication status display

Features of the IB-583

The IB-583 is fitted with both English and Russian interface. Choose desired interface as below:

English: Turn on the IB-583 while pressing the **E** key.

Russian: Turn on the IB-583 while pressing the **R** key.

The IB-583 has a battery (type CR2450-F2ST2L, code no. 000-144-941) on its TERM/CPU Board (16P0209) and its life is about six years. When the voltage of the battery is low, the time will be slow. When this occurs, contact your dealer about replacement of the battery.

Note: To switch between Russian and English input, press **Alt** while holding down **Shift**.
(This is available in Russian mode only.)

7.2.2 Keyboard

The terminal unit is operated from the keyboard, and is almost 100% keyboard controlled. Operation is simplified by the use of menus which you access by pressing a function key, labeled F1-F10 at the top of the keyboard. The figure below shows the function menus and their corresponding function keys.

Note: € (Euro mark) on  key is not used.

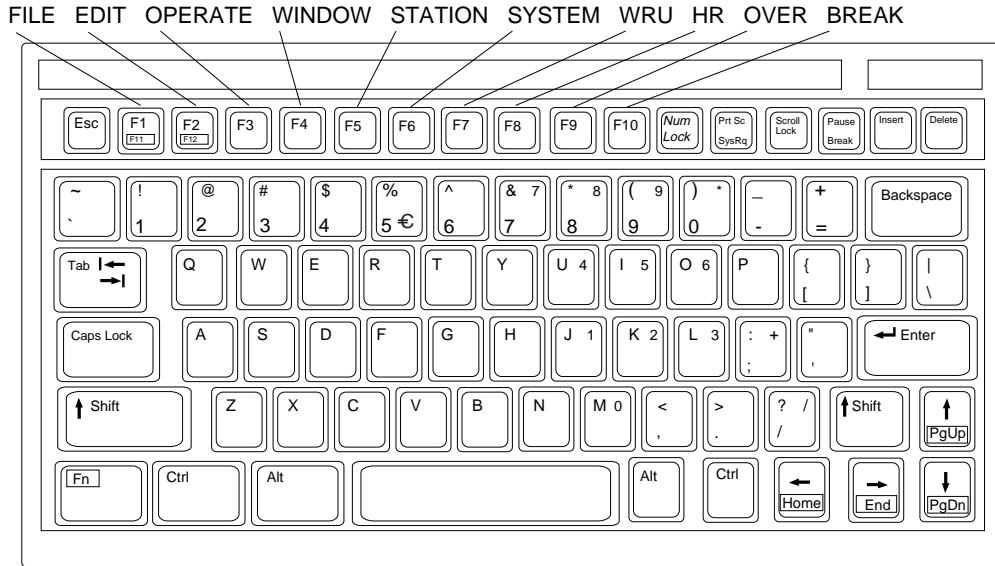

Keyboard for IB-581

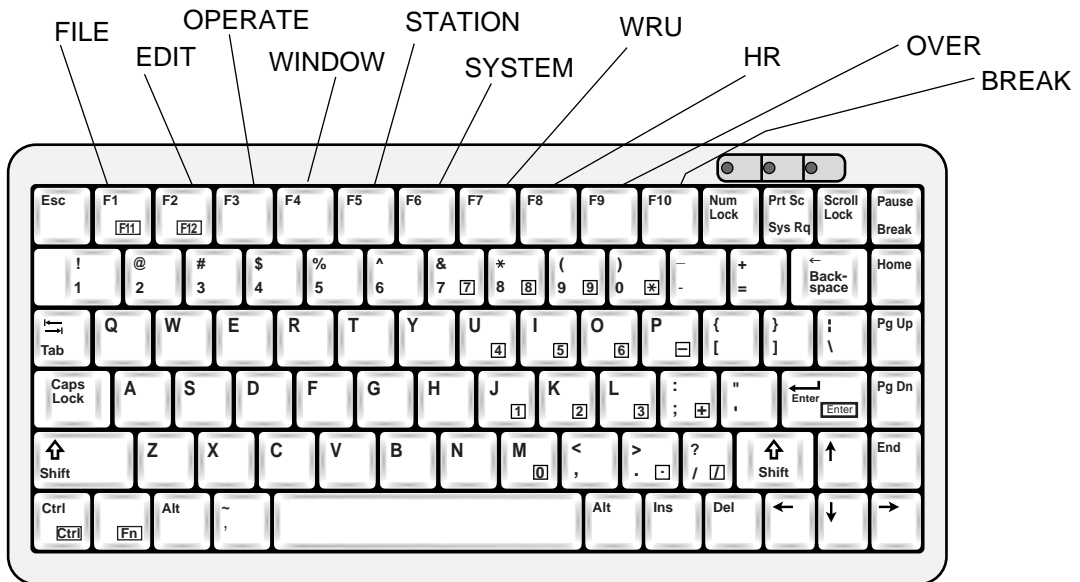

Keyboard for IB-583

7.3 Function Keys, Menu Operation

The function keys at the top of the keyboard control most operations of this unit through a menu system.

7.3.1 Menu conventions

Inverse video

As you move the cursor down through a menu, a selected item, initially shown as white on black (monochrome display), inverses to black on white. This highlighting indicates that it is available for selection.

Underline

The underline shows current selection. In the figure below, for example, the underline is beneath “ARQ” and “Channel.”

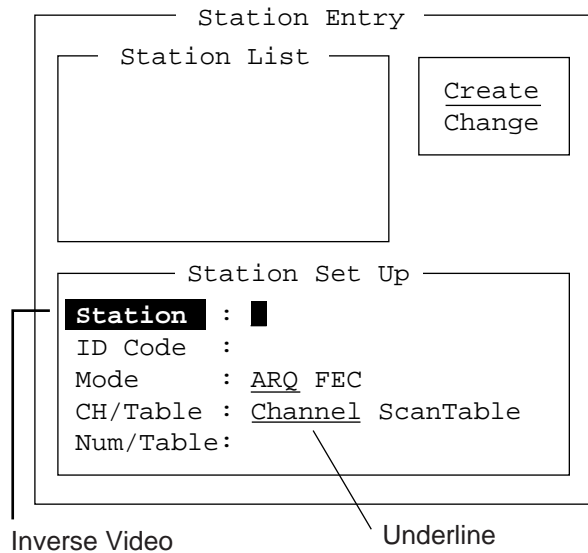

Station entry screen

Note: The example display screen shown in this manual are taken from the IB-583. The screens of the IB-581 are nearly identical to those of the IB-583 except cursor configuration.

Cursor	IB-581	IB-583
	—	■

7.3.2 Menu overview

Selecting menus

Press appropriate function key to open a menu. To display the File menu, for example, press the function key **F1**.

```
      File
-----
1: New
2: Open
3: Close
-----
4: Delete
-----
5: Rename
-----
6: Real Time Printing
7: File to Print
8: Cancel Printing
-----
9: Clear Buffer
-----
0: Floppy Disk Format
```

File menu

Selecting menu items and options

Menu items can be selected by pressing appropriate numeric key or selecting item desired with the arrow keys and pressing the **Enter** key. Menu options can be selected by operating the ← or → keys. After selecting option desired, press the **Enter** key to register your selection and close the menu.

Closing menu

Press the **ESC** key several times. To open the menu, press the function key to use.

7.3.3 Function key description

Function key [F1]: File menu

The File menu is where you will create, open, save and print telex messages. Floppy disks are also formatted from this menu.

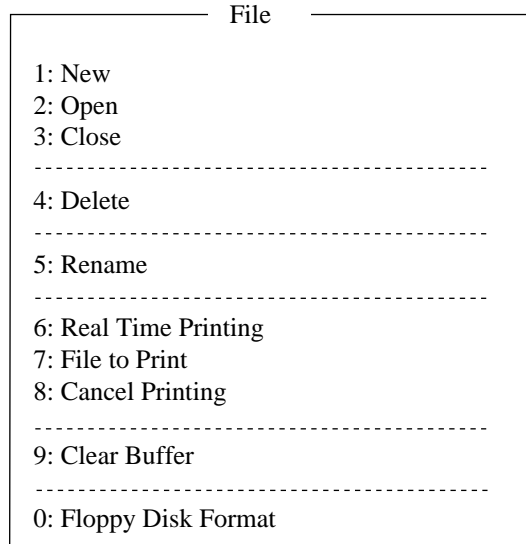

File menu

1: New	Opens a new untitled window.
2: Open	Opens files.
3: Close	Closes files.
4: Delete	Deletes files.
5: Rename	Renames files.
6: Real Time Printing	Turns real time printing on/off.
7: File to Print	Prints files.
8: Cancel Printing	Stops printing.
9: Clear Buffer	Clears the communications buffer.
0: Floppy Disk Format	Formats a floppy disk.

Function key [F2]: Edit menu

The Edit menu provides a full line of editing features.

```

      Edit
-----
1: Undo
-----
2: Cut
3: Copy
4: Paste
-----
5: Select All
-----
6: Search
7: Replace
-----
8: Goto Top
9: Goto Bottom
0: Goto Line
-----
A: Change Text

```

Edit menu

- | | |
|-----------------------|--|
| 1: Undo | Cancels the last change (cut, copy or paste). |
| 2: Cut | Removes the selected text and stores it in the paste buffer. (Previous text in the paste buffer is cleared.) |
| 3: Copy | Copies the selected text and stores it in the paste buffer. (Previous text in the paste buffer is cleared.) |
| 4: Paste | Inserts the text stored in the paste buffer at the current location of the cursor. |
| 5: Select All | Selects the entire current file for cut or copy. |
| 6: Search | Searches a file for a character string. |
| 7: Replace | Replaces a word with a different word or character string. |
| 8: Goto Top | Brings the cursor to the top line of the current file. |
| 9: Goto Bottom | Brings the cursor to last line of the current file. |
| 0: Goto Line | Moves the cursor to the desired line in the current file. |
| A: Change Text | Switches between the display window 1 and 2. |

Function key [F3]: Operate menu

The Operate menu mainly controls transmitting and receiving.

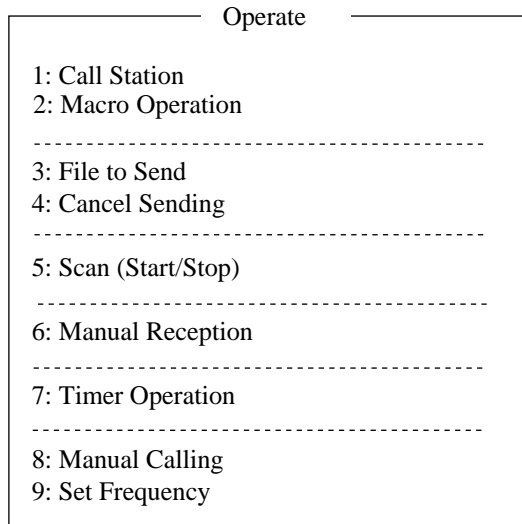

Operate menu

- | | |
|----------------------------|--|
| 1: Call Station | Chooses a station from the station list. |
| 2: Macro Operation | Enables macro operation. For details, see paragraph 10.10. |
| 3: File to Send | Selects a file (to transmit). |
| 4: Cancel Sending | Stops sending a file. |
| 5: Scan Start/Stop | Starts/stops frequency scanning. |
| 6: Manual Reception | Selects communication mode for reception; AUTO, ARQ, FEC DIRC. |
| 7: Timer Operation | Timer programming. |
| 8: Manual Calling | Sets TX mode and subscriber's ID number in manual calling. |
| 9: Set Frequency | Sets TX and RX frequencies in manual calling. |

Function key [F4]: Window menu

The Window menu lets you display the corresponding data of the window below.

Window
1: Calendar

2: Distress Frequency Table

Window menu

1: Calendar

Displays desired calendar month and year. To change year or month, choose item with ↑ or ↓ key and change setting with ← or → key.

2: Distress Frequency Table

Displays all distress frequencies.

Distress Frequencies						
Telephone (kHz):	2182.0	4125.0	6215.0	8291.0	12290.0	16420.0

NBDP (kHz) :	2174.5	4177.5	6268.0	8376.5	12520.0	16695.0

DSC (kHz) :	2187.5	4207.5	6312.0	8414.5	12577.0	16804.5

Function key [F5]: Station menu

The Station menu provides for storage of stations, timer program setup, user channel setup, and entry of various ID codes.

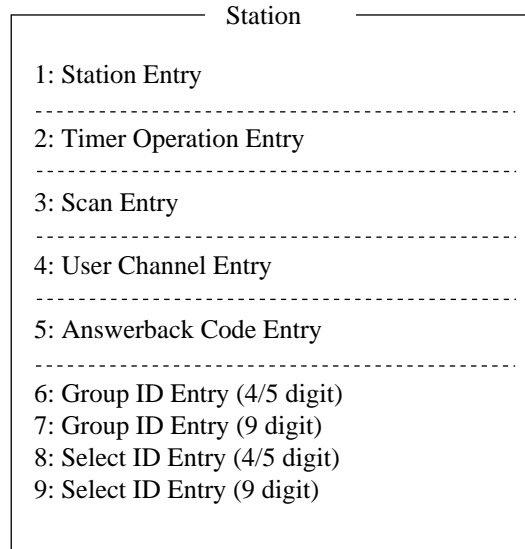

Station menu

- | | |
|---------------------------------|---|
| 1: Station Entry | Registers stations. |
| 2: Timer Operation Entry | Registers timer programs. |
| 3: Scan Entry | Creates scan groups for scanning. |
| 4: User Channel Entry | Registers user channels. |
| 5: Answerback Code Entry | Registers own ship's answerback code. |
| 6: Group ID Entry | Registers own ship's group ID codes (4 or 5 digit). |
| 7: Group ID Entry | Registers own ship's group ID codes (9 digit). |
| 8: Select ID Entry | Registers own ship's selective ID codes (4 or 5 digit). |
| 9: Select ID Entry | Registers own ship's selective ID codes (9 digit). |

Function key [F6]: System menu

The System menu is mainly for use by technicians and contains diagnostic tests. To change settings, choose "Change" from the item "Setup" and operate arrow keys to choose item and option. Press the **Enter** key to register selection and close the menu.

System	
Setup	Lock Change Default
Slave Delay	8 msec (0- 50 msec)
TX/RX MSG Save	OFF ON
Edit Before sending	OFF ON
Time System	OFF UTC SMT JST
Time & Date	2002/10/16 10:00:00
Window Color*	
Self Test	

*: Display mode" shown on IB-581

*System menu***Setup**

Locks, changes settings; restores default system settings.

Slave Delay

Sets the length of the slave delay timing from the end of RX to the start of TX in the ARQ mode. The default setting is suitable in most cases. This item cannot be adjusted by the user.

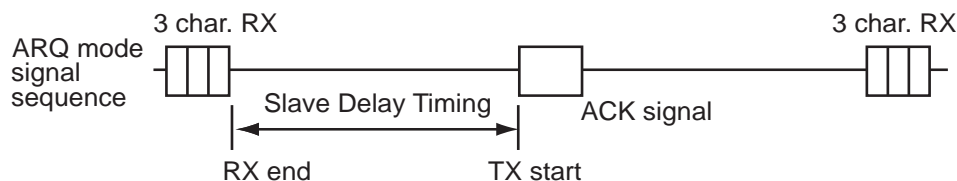
**TX/RX MSG Save**

Turn on to automatically save incoming and outgoing messages to a floppy disk. "Log" appears at the top of the screen when on.

Edit Before sending

"OFF" transmits keying operation one by one. "ON" transmits message only when the **Enter** key is pressed after confirming text typed.

Time System

Chooses time system.

UTC: Coordinated universal time

SMT: Local time

JST: Japan standard time.

Time & Date

Enter date and time manually. If a navigation device is connected, the time is automatically set when the power is turned on or whenever the time system is switched. Manual entry takes priority over automatic entry. This item cannot be adjusted when using JST or UTC.

Window Color (IB-583) Chooses display colors. To change display colors:

1. Choose the option Change from Setup.
2. Press the ↓ key to choose Window Color and press the **Enter** key.

```

Window Color Change
-----
Window Color Setup
Default Color
-----
To Change: ENTER To quit: ESC
    
```

3. The cursor is choosing Window Color Setup; press the **Enter** key.

```

Window Color Setup
-----
Window : [BASE WINDOW ]
Fore Color : [L-WHITE ]
Back Color : [BLUE ]
-----
To Change: ENTER To Change Value: L<=>R
    
```

4. Press the → key to choose the item to change: BASE WINDOW, BACK SCROLL, EDIT 1-2, FUNCTION, SUB MENU 1-3, MESSAGE.
5. Press the ↓ key to choose Fore Color.
6. Press the → key to choose color: L-WHITE, BLACK, BLUE, GREEN, CYAN, RED, MAGENTA, BROWN, WHITE, GRAY, L-BLUE, L-GREEN, L-CYAN, L-RED, L-MAGENTA, YELLOW.
7. Press the ↓ key to choose Back Color.
8. Press the → key to choose color.
9. Press the ↑ key to choose Window.
10. Repeat the step 4 to 9 to set other colors.
11. Press the **Enter** key followed by the **Esc** key.

Display Mode (IB-581) Selects display mode to normal and reverse alternately.

Self Test: Starts diagnostic test.

Function key [F7]: WRU (Who Are You?): In the ARQ mode, requests other station's answerback code.

Function key [F8]: HR (Here Is): In the ARQ mode, sends your ship's answerback code.

Function key [F9]: OVER: In the ARQ mode, switches the direction of traffic; the information receiving station becomes the information sending station, the information sending station becomes the information receiving station.

Function key [F10]: Break: Disconnects the line.

8. NBDP PREPARATIONS

This chapter provides the procedures necessary for preparing the NBDP Terminal Unit for transmitting and receiving. For automatic telex, you will need to register the following:

- Your ship's ID and answerback codes
- Stations
- Timer programs
- Scan channel groups
- User channels

8.1 Registering Answerback Code & ID Codes

Enter your ship's answerback code and ID codes as shown below.

Note: The answerback and ID codes cannot be changed once entered; be sure to enter the codes correctly.

8.1.1 Registering answerback code

1. Press the function key **F5** and then the **5** key. The display should look something like the illustration below.

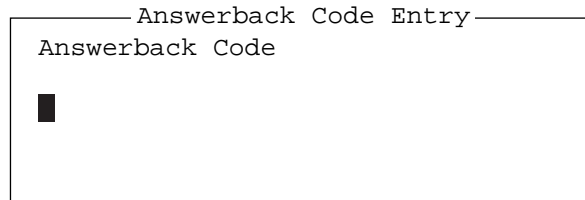

Answerback code entry screen

2. Enter your ship's answerback code (max. 20 characters, including spaces) and press the **Enter** key. The prompt "OK/Cancel" asks for verification of data. If the code is correct, press the **Enter** key again.

Note: Example of answerback code: 123456789 FURU X.

8. NBDP PREPARATIONS

For final verification of the data, the Caution shown in the illustration below appears.

Answerback Code Entry

Answerback Code

123456789 FURU X

OK

Cancel

Caution

Confirm the 'CODE' before pressing ENTER key.
You cannot change the CODE once it has been entered.

Message for confirmation of code entered

3. If the code is correct, press the **Enter** key again.

8.1.2 Registering ID codes

1. Press function key **F5** and then the **6**, **7**, **8** or **9** key to enter the Group ID Code (4 or 5 digits), Group ID Code (9 digits), Select ID Code (4 or 5 digits) or Select ID Code (9 digits), respectively.

Select ID Entry

Select ID Code (4/5)

■

ID code entry screen

2. Enter Group ID or Select ID as appropriate and then press the **Enter** key. A prompt asks you to verify data. If the ID is correct, press the **Enter** key.

For final verification of the data, the Caution shown in the illustration below appears.

Select ID Entry

Select ID Code (4/5)

12345

OK

Cancel

Caution

Confirm the 'CODE' before pressing ENTER key.
You cannot change the CODE once it has been entered.

Message for confirmation of code entered

3. If the ID is correct, press the **Enter** key again.

8.2 Station List

The station list provides for storage of up to 50 stations, one frequency pair (RX and TX) per station. For stations which have more than one frequency pair, you might add a suffix to the station name to denote multiple frequency pairs. For example, station name FURUNO followed by -1, -2, -3, etc. for each frequency pair required.

8.2.1 Registering stations

1. Press the function key **F5** followed by the **1** key to show the Station Entry screen.

Station entry screen

On the right-hand side of the screen, Create and Change are shown.

2. Create should be underlined. If it is not, underline it by pressing →, ↑ and the **Enter** key.
3. The cursor is now choosing Station. Enter station name, using up to 18 characters.
4. Press the ↓ key to choose ID Code. Enter station ID code.
5. Press the ↓ key to choose Mode. Choose communication mode with ← or → among the following:
 - ARQ:** Automatic Retransmission Request
 - FEC:** Forward Error Correction
6. Press the ↓ key to choose CH/Table. Choose Channel or ScanTable as appropriate.
7. Press the ↓ key to choose Num/Table.

8. NBDP PREPARATIONS

- If you selected "Channel" at step 6, enter ITU channel number (see Appendix) or User channel number.
- If you selected "ScanTable" at step 6, press the → key to show scan group list registered. For scan group, refer to paragraph 8.5.
- Choose a scan group name by using the ↓ or ↑ key followed by pressing the **Enter** key.



Scanning group list

- Press the **Enter** key. The prompt OK/Cancel asks for verification of data.



OK/Cancel prompt

- If the data are correct, press the **Enter** key. (To cancel entry, place the cursor on Cancel by pressing the ↓ key, and then hit the **Enter** key. Data entered are erased.) The station name entered at step 3 appears at the Station List window.
- To register other stations, press the **Enter** key twice and then repeat steps 3 through 10.
- Press the ↓ key. Check data on the Station List for correctness. Stations displayed in reverse video on the Station List are displayed on Station Set Up.
- Press the **ESC** key to quit.

Note 1: If you enter a station which already exists, the indication "Station by that name already exists. Press any key to escape." Appears. Press any key to return to the Station List. Check the list.

Note 2: If you enter an invalid code, the message "Input Error. (ID Code) Press any key to escape." Appears. Press any key and reenter ID code.

8.2.2 Editing/Deleting stations

- Press the function key **F5** and then the **1** key.
- Press the ↓ key to choose a station name from the Station List.
- Press the → key followed by ↓ key to choose Change and press the **Enter** key.
- Do one of the following;
 - Edit station:** Use ↑, ↓ and the **Backspace** key to make corrections.
 - Delete station:** Erase station name with the **Backspace** key.
- Press the **Enter** key twice.
- Press the **Esc** key.

8.3 Timer Programming

A built-in timer allows you to automatically receive and transmit files. 10 timer programs can be registered. To enable timer operation, see section 10-6.

8.3.1 Registering timer programs

1. Press the function key **F5** and the **2** key to display the Timer Operation Entry screen.

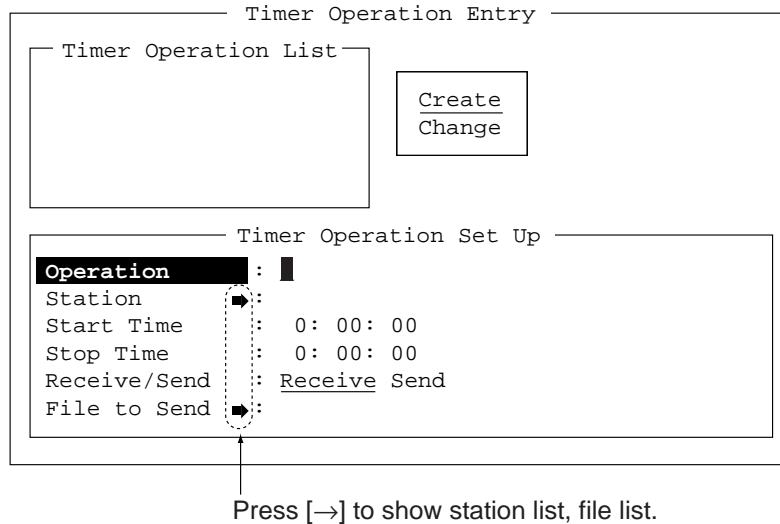

Timer operation entry screen

2. If Create is not underlined, press →, ↑ and the **Enter** key to underline it.
3. Operation is selected. Enter a suitable operation name on the Operation line. Any alphanumeric characters may be used.

Note: If the operation name entered already exists, the display “Operation name already exists. Press any key to escape.” Press any key and change the operation name.
4. Press the ↓ key to choose Station.
5. Press the → key to display the Station List (which you registered stations in the previous paragraph.)
6. Choose a station and press the **Enter** key.
7. Press the ↓ key to choose Start Time. Enter start time, in 24-hour notation. To have the operation start at 8:35 a. m., for example, the keying sequence would be;
0 8 3 5 0 0
8. Press the ↓ key to choose Stop Time. Enter stop time, in 24-hour notation.
9. Press the ↓ key to choose Receive/Send. Choose operation category; Receive or Send. If you have chosen “Send,” go to step 10. For “Receive,” go to step 12.
10. For send, insert the floppy disk which you want to send in the floppy drive, press the ↓ key to choose File to Send.
11. Press the → key to display the TX window, choose a file, and press the **Enter** key twice.
12. Press the **Enter** key.
13. Press the **Enter** key. The operation name appears in the Timer Operation List.
14. To enter another timer program, press the **Enter** key twice and the repeat steps 3-11.
15. Press the **Esc** key to finish.

8.3.2 Editing/Deleting timer programs

1. Press the function key **F5** and the **2** key.
2. Choose a timer program name from the Timer Operation List.
3. Press the **→** key to choose Change and press the **Enter** key.
4. Do one of the following;
 - Edit program:** Use **↑**, **↓** and the **Backspace** key to make corrections.
 - Delete program:** Erase operation name with the **Backspace** key.
5. Press the **Enter** key twice.
6. Press the **Esc** key.

8.4 User Channels

The user channel list provides storage for up to 100 user channels, numbered 0-99. Note that user channels may be used in channel scanning.

8.4.1 Registering user channels

1. Press the function key **F5** and then the **4** key to show the User Channel Entry screen.

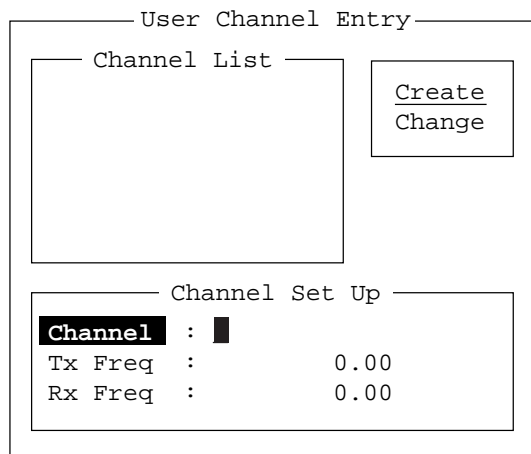

User channel entry screen

2. If Create is not underlined, press **→**, **↑** and the **Enter** key to underline it.
3. Channel is selected. Enter channel number.
 - Note 1:** 100 channels may be registered. When you attempt to register more, the message “Channel memory is full. Press any key to escape.” Appears. In this case delete unnecessary channels to register new ones.)
 - Note 2:** If the channel entered already exists, the message “Channel by that number already exists. Press any key to escape.” Appears. Press any key and then reenter number.
4. Press the **↓** key to choose “Tx Freq.” Enter TX frequency.
5. Press the **↓** key to choose “Rx Freq.” Enter RX frequency.
6. Press the **Enter** key. The “OK/Cancel” confirmation window appears.
7. Press the **Enter** key. Channel number entered appears in the Channel List.
8. To quit, press the **Esc** key.

8.4.2 Editing/Deleting user channels

1. Press function key **F5** and then the **4** key.
2. Press the **↑** or **↓** key to choose channel from the Channel List.
3. Press **↓** and **→** keys to choose Change and press the **Enter** key.
4. Do one of the following:
 - Edit channel:** Use **↑**, **↓** and the **Backspace** key to make modifications.
 - Delete channel:** Erase channel number with the **Backspace** key.
5. Press the **Enter** key twice.
6. Press the **Esc** key.

8.5 Scan Channel Groups

You may store up to 10 scan groups, 20 channels per group. Note that scanning is only possible in the ARQ and FEC modes.

The NBDP Terminal Unit can control radio equipment through channel scanning. In FEC mode, the radio equipment scans a number of channels (according to your selection), stopping when an incoming signal is found. In the ARQ mode it stops when your own ID code is detected in an incoming signal. Also, in the ARQ mode, the transmitter is then tuned to the corresponding transmitter frequency, the communication link is established and the traffic is automatically exchanged. Scanning resumes once the link is disconnected.

8.5.1 Registering scan channel groups

You may register ITU and user scan channels as follows:

1. Press the function key **F5** followed by the **3** key to display the Scan Entry screen.

Scan Entry

Scanning Group List

Create
Change

Scanning Set Up

Group Name : █

Ch Dwell Time : 4.5 sec (2.7-4.5 sec)

Mode : AUTO ARQ FEC

Auto Search : OFF ON

No	Channel	Rx Freq	Tx Freq	Pass/Scan
0				Pass/Scan
1				Pass/Scan
2				Pass/Scan
3				Pass/Scan
4				Pass/Scan
▼ 5				

Scan entry screen

2. If Create is not underlined, press **→**, **↓** and the **Enter** key to underline it.
3. Group Name is selected. Enter suitable group name. (10 group names may be entered. If you attempt to enter more the message "Scan group memory is full. Press any key to escape." Appears. Press any key and then delete unnecessary group names to enter

8. NBDP PREPARATIONS

new ones. If the group name already exists, the message "Scan group by that name already exists. Press any key to escape." Appears. Press any key and change the scan group name.)

4. Press the ↓ key to choose Ch Dwell Time. Enter channel dwell time in seconds. Dwell time is the time in seconds the receiver waits on each channel in a scan group before it selects the next frequency.
5. Press the ↓ key to choose Mode, and then choose the communication mode; AUTO, ARQ or FEC.

Note: AUTO is used to register scanning channel group when both ARQ and FEC exist in the same Scanning Channel Group. When you choose scan group by the call station menu, set Mode to FEC. See paragraph 10.3.

6. Press the ↓ key to choose Auto Search. Choose Auto Search to ON or OFF.

Auto Search ON: The radio stops scanning when it finds the strongest signal (highest S/N ratio). To find the strongest signal, the radio scans all channels, which may take some time. Therefore, use this setting where signal propagation is poor.

Auto Search OFF: The radio stops scanning on the first signal it finds. We recommend that you set Auto Search to OFF when signal propagation is good.

7. Press the ↓ key to choose line no. 1 in the Scanning Set Up window.
8. Enter channel number (ITU or user channels) and press the → key to choose "Scan." (If you enter an invalid channel, the message "Channel by that number does not exist. Press any key to escape." Appears. Press any key and reenter channel.)
9. Press the ↓ key to choose line No. 2. Enter channel number.
10. Enter other channel numbers and then press the **Enter** key. A confirmation message appears.
11. Press the **Enter** key again to save the data. The group name is displayed in the Scanning Group List window.
12. To continue, press the **Enter** key twice and then repeat steps 3-10.
13. Press the **Esc** key to quit.

8.5.2 Editing/Deleting scan channel groups

1. Press the function key **F5** and the **3** key.
2. Choose scan group name from the Scanning Group List.
3. Press the → key to choose Change and press the **Enter** key.
4. Press the ↓ key to place the cursor on the field (channel) to change.
5. Do one of the following:
 - Editing channels:** Press the Backspace key to delete the channel number and then enter new channel number.
 - Adding channels:** Enter channel number on a blank line.
 - Deleting scan group:** Delete group name with the **Backspace** key.
 - Disabling channels temporarily:** Press the ← key to underline Pass.
6. Press the **Enter** key twice.
7. Press the **ESC** key.

9. NBDP FILE OPERATIONS

This chapter mainly describes how to create, save, open, edit and print files. The Edit menu provides a full lineup of editing facilities, including search and replace.

9.1 Opening and Closing Files

To create a telex message you will need to make a new file, which you do with the File Open command. When you open a new file it is placed (opened) in one of two working areas. When both working areas are occupied you must close a file to open a new file. This is done with the File Close command.

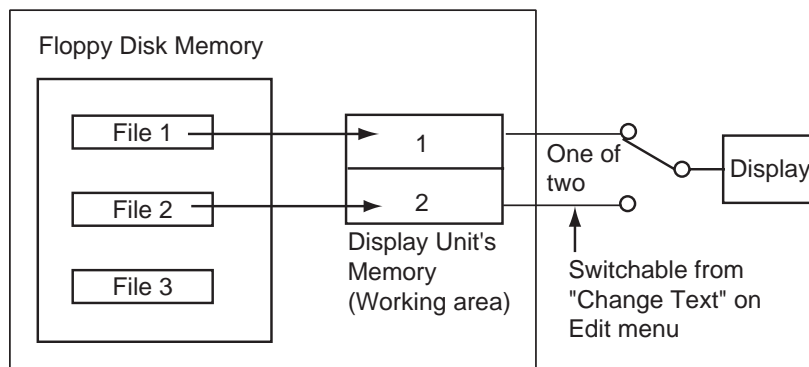

How a file is opened

9.2 Creating Files

1. Press the function key F1 to display the File menu.



File menu

2. Press the 1 key to choose New. The title bar shows UNTITLED 1 or UNTITLED 2. The cursor marks the location where you may type text.
3. Type your message.

Note: Do not use lower case letters, or the symbols #, &, *, \$ and % in telex messages. Also, do not put “\$\$\$” in the middle of a TX message, but at the end. The communication line is automatically disconnected when this string is detected.

9.3 Saving a File

Use only 2HD type floppy disks. Insert floppy disk with care. Rough handling can destroy the information stored inside. To eject a disk, press the eject button on the right side of the floppy disk drive and then remove the disk. Do not eject a disk while the operating lamp is lit; the contents of the disk may become damaged.

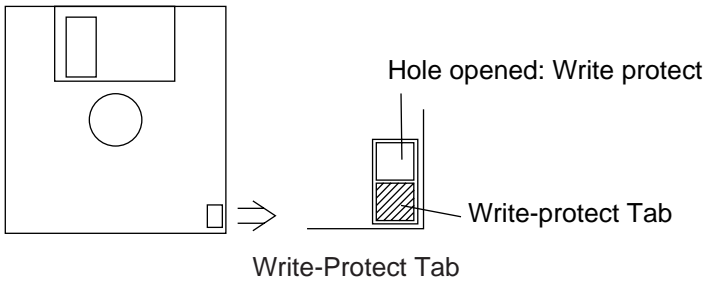

9.3.1 Formatting floppy disks

Before you can save a file to a floppy disk, the disk must be formatted. Formatting prepares the disk for use in the system.

1. Press function key **F1**, and insert a new floppy disk in the disk drive.
2. Press the 0 key to choose Floppy Disk Format.
3. Press the ↑ key to choose Yes.
4. Press the **Enter** key. For the IB-581, insert a new floppy disk in the drive
5. Press the **Enter** key. For the IB-583, the screen shows formatting progress as below.



6. After formatting has been completed, the following occurs;
IB-581: You are asked “Format another (Y/N)?” Press **N** and **Enter** to quite.
IB-583: Control is returned to the standby screen.

9.3.2 Saving a file

1. Press the function key **F1** to display the File menu.
2. Press the **3** key. The screen should look something like the illustration at right.

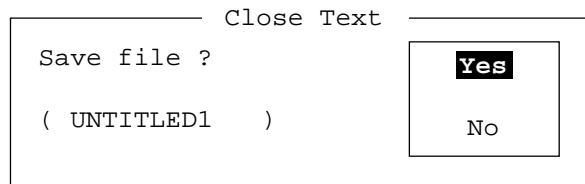

Close text screen

3. Yes is selected; press the **Enter** key.
4. Enter file name, using up to eight characters.
You may use any alphabet or numeric on the keyboard. But you may not use the symbols shown below. You may add an extension at the end of the file name, for example, .TXT, to distinguish text files from macro files.

| ¡ : " > < ;

5. Press the **Enter** key.

9.4 Editing Files

9.4.1 Cutting and pasting text

You can delete, move and copy text by using the Cut, Copy and Paste functions in the Edit menu.

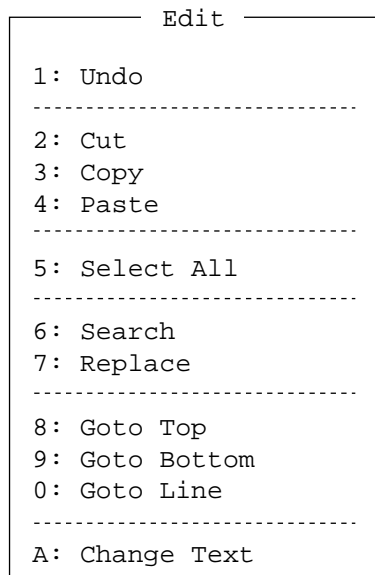

Edit menu

Cutting text

1. Place the cursor on the first character of the text to be cut.
2. Highlight the text to be cut by pressing and holding the **Shift** key while pressing the →. If you highlight text which you do not want to cut, press the ← to adjust the highlight.

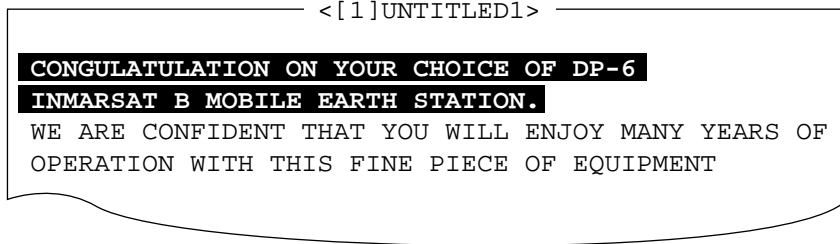

The highlight

3. Press the function key **F2** and the **2** key, or the **Delete** key. The highlighted text is cut and the remaining text is reformatted.

If you make a mistake, you can restore the text by immediately selecting Undo from the Edit menu.

Pasting text

To paste the cut text to a new location, do the following:

1. Place the cursor at the exact spot in the message where the cut text is to start.
2. Press the function key **F2** and the **4** key, or the **Insert** key.

9.4.2 Copying and pasting text

You may copy a portion of text and paste it elsewhere.

1. Choose the text to copy. (See "cutting text" above for the procedure.)
2. Press the function key **F2** and the **3** key.
The text selected is copied to the paste buffer memory where the cut or copied text is stored. The display returns to the normal screen.
3. Place the cursor at the exact spot in the message where the copied text is to start.
4. Press the function key **F2** and the **4** key.

9.4.3 Select all

The Select All feature lets you select all of the file currently displayed. This feature can be useful when you want to combine files. The procedure below explains how to place the file loaded in working area 1 onto the end of the file loaded in working area 2.

1. Load the file to be copied from a floppy disk in working area 1.
2. Press the function key **F2** and the **5** key. The entire file appears in inverse video.
3. Press the function key **F2** and the **3** key. The file is placed in the paste buffer memory.
4. Load the file to be combined in working area 2.
5. Place the cursor at the exact spot in the message where the text now in the paste buffer memory is to start and press the Insert key.

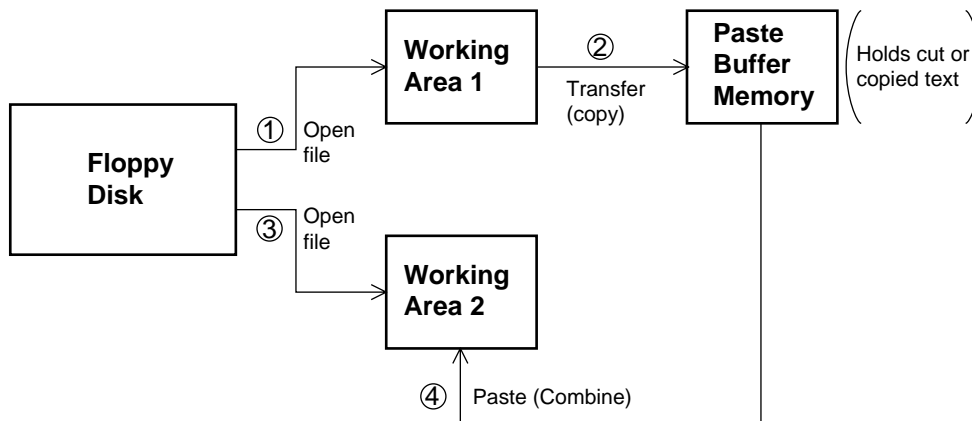

Copy and paste flow diagram

9.4.4 Searching text

The Search feature lets you search for text in a forward or backward direction.

1. Display a text and press the function key **F2** and the **6** key. The Search display appears.

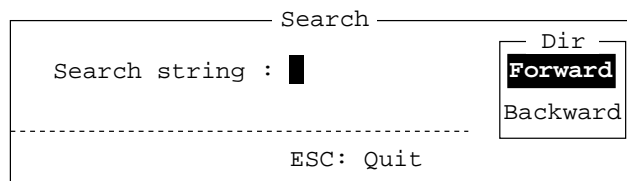

Search screen

2. Type the word you want to find. Press the **→** key. Use **↑** or **↓** to choose "Forward" or "Backward" to search the file in a forward or backward direction respectively from the cursor position. Press the **Enter** key to begin the search.

When the unit finds the word, the cursor stops at the first character of the word. Press the **Enter** key to continue the search. If the string could not be found, the message "Not Found (To quit: ESC)" appears. Press the **Esc** key to quit.

9.4.5 Replacing text

The Replace feature helps you replace every occurrence of a word or phase with another word or phase in a file.

1. Press the function key **F2** and the **7** key. The Replace display appears.

Replace	
Search string : █	Dir
Replace with : _____	Forward
_____	Backward
	Mode
	Query
	All
To quit: ESC	

Replace screen

2. Type the word you want to replace on the "Search string" line.
3. Press the ↓ key to choose "Replace with." Type the new word.
4. Press the → key.
5. Use the ↑ or ↓ key to choose Forward or Backward to search the file in a forward or backward direction respectively from the cursor position.
6. Press the → key.
7. Use the ↑ or ↓ key to choose whether you want to be queried or not each time the word is found.

Query: Stop at each occurrence of word to answer yes or no to replacement.

All: Replace every occurrence of word without stopping to confirm.

8. Press the **Enter** key to start the replacement.

9.4.6 Goto line

The Goto line feature places the cursor at the head of a line desired.

1. Press the function key **F2** and the **0** key. The following display appears.

Goto Line
Jump to Line No. : █_____

Goto line screen

2. Key in line number and press the **Enter** key. The cursor shifts to the head of the line selected.

9.4.7 Goto top, Goto bottom

You can easily go to the top or bottom line of a file. Press **F2, 8** to go to the top line; press **F2, 9** to go to the bottom line. Note that this feature can also be executed on the editor screen by pressing the **Home** or **End** key while pressing the **Fn** key.

9.5 Opening Files

Two working areas (called working area 1 and working area 2) are provided to which you can load a file, and one file may be displayed on the LCD.

9.5.1 Opening a file

1. Insert the floppy disk which contains the file you want to open.
2. Press the function key **F1** to display the File menu.
3. Press the **2** key. A chronological list of files on the floppy disk appears.

```

----- Open Text -----
Load/Merge (TAB:Change)
[A:\TEST1. ]
-----File name-----Size-----Date & Time-----
LOG File           52      02-10-15 17:25
TEST1.           120      02-10-15 16:30
TEST2.             151      02-10-15  9:25
TEST3.             180      02-10-15 20:16
NBDP               169      02-10-15  6:23
[----- End of Directory-----]

4 Files exist                1454000 bytes free

-----
To select : ENTER  To view : SPACE  To quit : ESC

```

4. Use the **↑** or **↓** key to choose a file.
5. Press the **Enter** key.

The file appears and the title bar shows the file name. You may repeat this procedure to load another file into a working area.

Note: When two working areas have been opened, the close confirmation window appears. In this case, choose Yes or No and press the **Enter** key to close an open file in order to open another file.

9.5.2 Switching between files

Two files can be opened and one displayed on the LCD. To switch between files do the following:

1. Press the function key **F2**.
2. Press the **A** key to switch between files.

9.6 Renaming Files

To rename a file, do the following:

1. Press the function key **F1**.
2. Press the **5** key.
3. Use the **↑** or **↓** key to choose a file and press the **Enter** key.

9. NBDP FILE OPERATIONS

4. Enter a new name.
5. Press the **Enter** key.

9.7 Saving a File Under a New Name

You may save a file under a new name as follows:

1. Open a file.
2. Edit the file as necessary.
3. Press the function key **F1**.
4. Press the **3** key to save the file.
5. Press the **Y** key.
6. Press the **Backspace** key to erase the original name and then enter a new name.
7. Press the **Enter** key.

9.8 Deleting Files

Insert appropriate floppy disk in the drive and do the following to delete unnecessary files.

1. Press the function key **F1**.
2. Press the **4** key.
3. Use the **↑** or **↓** key to choose the file to delete and then press the **Enter** key.
4. Press the **Enter** key again. (To cancel, press the **↓** key to select NO followed by the **Enter** key.)

9.9 Real Time Printing

An incoming or outgoing message can be printed out while it is being received or transmitted.

1. Press the function key **F1** to display the File menu.
2. Press the **6** key to turn real time printing on/off.

When the real time printing is on, "Print" appears in reverse video at the top of the display.

9.10 Printing Files

You can print files stored on floppy disks as follows:

1. Press the function key **F1**.
2. Press the **7** key.
3. Use the **↑** or **↓** key to choose a file and press the **Enter** key.
4. Press the **Y** key.

To stop printing at any time, press **F1** and **8** keys.

If the file could not be printed, "Cannot print. Check connection between printer and terminal. Press any key to escape." Is displayed.

10. NBDP TRANSMITTING, RECEIVING

This chapter mainly shows you how to transmit and receive telex messages.

10.1 Manual Calling

NOTICE

Before calling, watch the intended TX frequency carefully to confirm that is unoccupied.

The simplest way to communicate with a telex subscriber is Manual Calling. For the ARQ mode, you may display beforehand the message to send, or type your message manually.

1. Press the function key **F3** to display the Operate menu.

```

      Operate
-----
1: Call Station
2: Macro Operation
-----
3: File to Send
4: Cancel Sending
-----
5: Scan (Start/Stop)
-----
6: Manual Reception
-----
7: Timer Operation
-----
8: Manual Calling
9: Set Frequency

```

Operate menu

2. Press the **9** key to choose Set Frequency.

```

      Set Frequency
-----
Tx Freq:      0.00
RX Freq:      0.00

```

Set frequency screen

3. Input Tx and Rx frequency pair.
4. Press the **Enter** key.

10. NBDP TRANSMITTING, RECEIVING

5. Press the function key **F3** again and then the **8** key to choose Manual Calling. The following screen appears.

```
----- Manual Calling -----  
Mode : ARQ FEC  
ID   :
```

Manual calling screen

6. Use the ← or → key to choose appropriate communication mode.
7. Press the ↓ key and input party's ID number.
8. Press the **Enter** key to connect the communication line. "Channel Busy Check" appears. If the line is free, "Connect", "Send" and "Lock" appear in highlight as below. Further, "HT" (High Tension) also appears when the line is connected.

```
1:File 2:Edit 3:Operate 4:Window 5:Station 6:System 7:WRU 8:HR 9:Over 10:Break  
----- 2002-09-08 2:14:28 UTC -----Caps-Eng  
Station Name      :  
Frequency (T/R)  : 8765.00 / 8965.00(kHz)  Comm Mode :ARQ  
Comm Status      : Connect Send Lock Error  
Sending Volume   : 100(%)  ARQ Error : 0  ARQ Time : 0(sec)  
-----
```

For ARQ mode, go to step 9. For FEC mode, type your message and go to step 13.

9. Press the function key **F7** (WRU). The party's answerback code appears on the screen.
Note: Step 9 and 10 are needed for ship-to-ship calling only.
10. Press the function key **F8** (HR). Your ship's answerback code is sent to the party.
11. Press the **Enter** key and type your message.
12. If you want to receive other party's response, press the function key **F9** (Over).
13. Press the function key **F10** (Break) to disconnect the line.

10.2 ARQ Mode Operation

In ARQ operation, one station (information sending station) sends data to another block by block, then listens for the acknowledge signal between blocks from the information receiving station which requests either the next block or retransmission of the last block if there is error. The request may be repeated up to 32 times, until the complete block is received free of error.

Establishing connection

1. Press the function key **F3** to display the Operate menu.

```

      Operate
-----
1: Call Station
2: Macro Operation
-----
3: File to Send
4: Cancel Sending
-----
5: Scan (Start/Stop)
-----
6: Manual Reception
-----
7: Timer Operation
-----
8: Manual Calling
9: Set Frequency
  
```

2. Press the **1** key to choose Call Station.

```

1:File 2:Edit 3:Operate 4:Window 5:Station 6:System 7:WRU 8:HR 9:Over 10:Break
-----
2002-01-15 14:41:09 UTC ---- Caps-Eng
Station Name      : CHOUSHI-8M
Frequency         :
Comm Sta:
Sending
-----
      Station List      Station Setup
-----
ABC-4M
ABC-6M
ABC-12M
ABC-8M
FURUNO
Station : ABC-4M
ID Code  : 45678
Mode     : ARQ FEC
CH/Table : Channel Scantable
Num/Table:
  
```

Call Station menu

3. Choose a station. (Station must be registered for use in the ARQ mode). Press the **Enter** key. The message "Calling Station" appears. If the message shown below appears, check both the power of the radiotelephone and the connections between the radiotelephone and the NBDP Terminal Unit.
 "Station calling suspended. Check interconnections between the terminal and main units. Press any key to escape."
4. When an acknowledge signal is detected, "Connect" appears in reverse video on the communication status display.

10. NBDP TRANSMITTING, RECEIVING

Note: If signal conditions are poor, connection may take a while. If the line could not be connected in one minute, calling stops and “Calling failed” appears. Try step 3 again, one minute later. Should signal conditions worsen during message transmission, “Error” appears in reverse video and 30 seconds later the line is disconnected.

5. Transmit message by one of the following methods:

Sending a file stored on a floppy disk

1. Press the function key **F7** (WRU) to receive the answerback code of the other station. Verify that the code from the station called is correct.
2. Press the function key **F8** (HR) to transmit your own identity (answerback code).
3. Press the function key **F3** and then the **3** key to display the Send file screen.
4. Choose file to send and press the **Enter** key.
5. Press the **Enter** key again.

```
----- Send File -----
[A:\TEST1. ]
-----File name-----Size-----Date & Time-----
LOG File           52    02-10-15 17:25
TEST1.           120    02-10-10 16:30
TEST2.             151    02-10-11 09:25
TEST3.             180    02-10-11 20:16
NBDP               169    02-10-12 06:23
[----- End of Directory -----]

4 Files exist                1454000 bytes free
-----
To select : ENTER  To view : SPACE  To quit : ESC
```

Send file screen

Sending volume (percentage of message transmitted, counts upward as the message is being transmitted), ARQ error count and ARQ transmission time appear on the display. “Lock” appears in reverse video when the mark and space signals in the receive signal are normal. “ARQ Error” shows the number of times error was found during transmission. “ARQ Time” is the time in seconds the communication line has been established.

```
1:File 2:Edit 3:Operate 4:Window 5:Station 6:System 7:WRU 8:HR 9:Over 10:Break
----- 2002-09-08 2:14:28 UTC -----Caps-Eng
Station Name      :
Frequency (T/R)   : 8765.00 / 8965.00(kHz)  Comm Mode :ARQ
Comm Status       : Connect Send Lock Error
Sending Volume    : 100(%)  ARQ Error : 0  ARQ Time : 0(sec)
-----
```

Communication status display

6. After the message is transmitted, press the function key **F10** (Break) to disconnect the line.

Type a message from the keyboard

1. After exchanging answerback code by the function key **F7** (WRU) and **F8** (HR), type your message directly from the keyboard.
2. To change direction of traffic, press the function key **F9** (OVER), or **+**, **?** in order. Then, the other station becomes the information sending station, your station becomes the

information receiving station.

3. Receive a message from the sending station.
4. After completion of communication, press the function key **F7** (WRU) key to receive the answerback code of the other station and then press the function key **F8** (HR) to transmit your own answerback code.
5. Press the function key **F10** (Break) to disconnect the line.

Stopping transmission

1. Press the function key **F3** and then the **4** key. "Canceled Sending" appears on the screen. Transmission is stopped but the line is still connected.
2. To disconnect the line, press the **F10** key.

10.3 FEC Mode Operation

The FEC mode transmits the same data twice to yield less errors. Compared to the ARQ mode, the FEC mode is better at communicating with weak signals.

1. Press the function key **F3**.
2. Press the **1** key to display the Call Station menu.
3. Choose a station which is registered for the FEC mode.
4. Press the **Enter** key. "CONNECT" appears in reverse video.
5. Transmit a message directly from the keyboard, or do the following to transmit a message stored on a floppy disk:
Press the function key **F3** and the **1** key to choose File to Send. Choose file to send and then press the **Enter** key.
6. After the message is transmitted, press the function key **F10** (Break) to disconnect the line.

10.4 Choosing Receive Mode

1. Press the function key **F3** and then the **6** key.
2. Choose receive mode:
 - AUTO:** Automatic reception in ARQ or FEC mode
 - ARQ:** International radiotelex ARQ mode
 - FEC:** International radiotelex FEC mode
 - DIRC:** Receive message from teleprinter
3. Press the **Enter** key. The reception mode appears on the screen.

All received (and transmitted) messages are saved to a floppy disk when "TX/RX MSG Save" is ON in the System menu. The file is automatically named as follows.

02	01	13	0	0.	X	X	X
↑	↑	↑			↑		
Year	month	date			Serial number from 000		

10.5 Communication Example

Call the coast station following the procedure in paragraph 10.2. Then, communicate with the coast station. Below is a communication example.

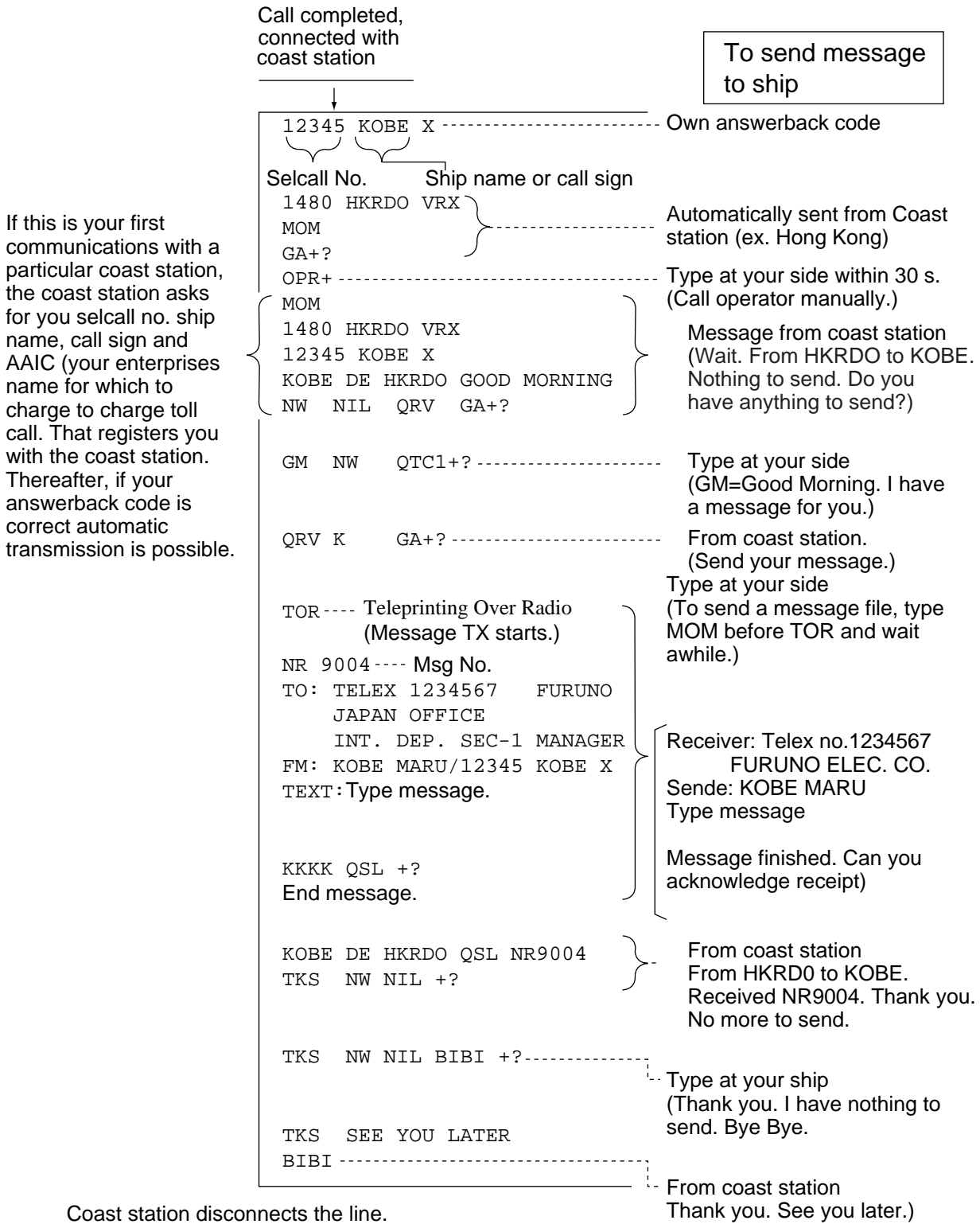

Communications example

Table of abbreviations

Abbreviation	Question	Answer or Advice
QRA	What is the name your station?	The name of my station is
QRC	By what private enterprise are the accounts for charges for your station settled?	The accounts for my station are settled by the private enterprise
QRU	Have you any thing for me?	I have nothing for you.
QRV	Are you ready?	I am ready.
QRX	When will you call me again?	I will call you again at hours [on kHz].
QSJ	What is the charge to be collected to . . . including your internal charge?	The charge to be collected to including my internal charge is francs
QSL	Can you acknowledge receipt?	I can acknowledge receipt.
QSX	Will you listen to [call sign] on kHz?	I am listening to [call sign] on kHz.
QTA	Shall I cancel message number ?	Cancel message number
QTC	How many messages have you to send?	I have message for you.
QTU	What are the hours your station is open?	My station is open from to hours.
Abbreviation	Definition	
BK	Signal used to interrupt a transmission progress.	
CFM	Confirm	
DE	"From "	
K	Invitation to transmit.	
NIL	I have nothing to send to you.	
NW	Now	
PSE	Please	
R	Received	
REF	Reference to	
SVC	Prefix indicating a service telegram.	

Command and abbreviation

Command	Function
TGM+	To indicate that the following message is a radiotelegram.
MSG+	To indicate that the ship station needs to be connected immediately any message held.
OPR+	Call operator.
URG+	Safety, urgency and distress message.
MED+	Request medical advice.
TEST+	Request coast station to send a test message for checking the ship station.
BRK+	To clear the connection with the coast station.
Abbreviation	
GA+	I am ready. Transmit your command.
MOM	Wait a moment.
MSG+	Request pending messages from the shore.
KKKK or NNNN	Terminate a message.
XXXXX	Typo

10.6 Timer Operation

A built-in timer permits automatic transmission and reception of telex messages.

10.6.1 Enabling timer operation

1. Press the function key **F3** to display the Operate menu.
2. Press the **7** key to display the Timer Operation List.
3. Choose the operation (name) you wish to execute.
4. Press the **Enter** key. An asterisk appears beside the operation selected and "T. Op" appears in reverse video on the communication status display. If a file stored on a floppy disk is to be sent, be sure the floppy disk containing the file is inserted in the drive.

```

Timer Operation List
-----
*1
 2
 3
OP4
OP5

```

Timer operation list

5. Choose another operation (name) if desired.
6. Press the **Esc** key.

When the predetermined time comes, the NBDP Terminal Unit automatically sends or receives the message. The results of timer operation are displayed as either OK or NG (No Good) on the Timer Operation List.

Timer Operation List	
*1	OK
2	
*3	OK
*OP4	OK
*OP5	NG

Timer operation list

10.6.2 Stopping timer operation

1. Press the function key **F3**.
2. Press the **7** key.
3. Choose the operation (name) which has an asterisk attached to it and then press the **Enter** key. Remove all asterisks to cancel all timer programs.

10.7 Scanning

The radio equipment scans a group of operator-selected frequencies (channels), and stops scanning when a signal is received. For registering scan group, see paragraph 8.5.

1. Press the function key **F3** and then the **5** key to show the Scanning Group List on your screen.

You can confirm the scan channel by pressing the **↑** or **↓** key while pressing the **Shift** key.

Scanning Group List	
1	
2	
3	

Scanning group list

2. Choose a scan group and press the **Enter** key.
3. The scanning starts and the indication "Scan" appears in reverse video. Further, the name of the scan group appears in the Station Name field.

```
1:File 2:Edit 3:Operate 4:Window 5:Station 6:System 7:WRU 8:HR 9:Over 10:Break
-----2002-09-08 2:01:46 UTC -----Caps-Eng
Station Name      : SAITO-1          Scan          HT
Frequency (T/R)  : 8344.00 / 8705.00(kHz)  Comm Mode : Auto
Comm Status      : Connect Send Lock Error
Sending Volume   : 100(%)  ARQ Error : 0  ARQ Time : 0(sec)
-----
```

Communication status display

4. To stop scanning, press the function key **F3** and then the **5** key. "Scan" disappears on the communication status display.

10.8 Communication Buffer

The communication buffer is a temporary memory which stores transmit and receive messages. To display the contents of the communication buffer, do the following:

1. Escape from the message creation screen.
2. Press the ↓ key while pressing the **Fn** key or the ↑ key pressing the **Fn** key. The contents of the communication buffer are displayed.

To print them, press the **Ctrl** and **P** keys simultaneously. To erase the contents from the screen, press the ↓ key at the bottom line.

To erase the contents of the buffer, press the **F1** and **9** keys.

10.9 Preparing Macrofiles for Automatic Telex

10.9.1 Automatic telex overview

This section shows you how to communicate with a coast station which handles automatic telex transmission, using macrofiles. You will also need to register communication channels and stations, and prepare macrofiles.

Coast stations using automatic telex are MCI Marine Services (North America), Sydney Radio (Australia), Lyngby Radio (Denmark), and others. The procedure is mostly common to all coast stations, however refer to the coast station's traffic manual for details.

INTERNATIONAL
TELEX NETWORK

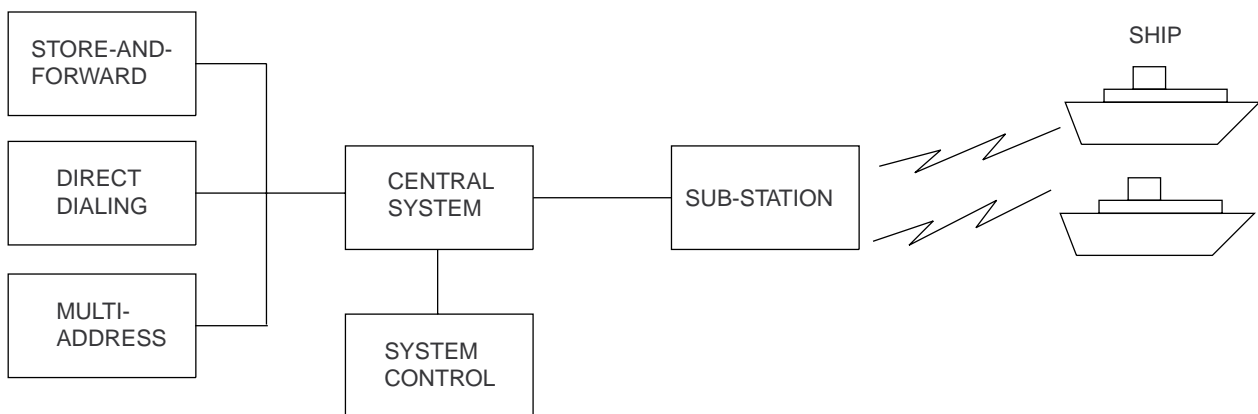

Sample automatic telex network

The service available in automatic telex are
Message transfer between ship and coast station (store-and-forward)
Connection with landline telex (direct dialing)
Multi address.

10.9.2 Preparations

To use automatic telex, you will need to register three items:

- Answerback code
- Scan groups
- Station names

Registering answerback code

The coast station assigns a Telex number. This number functions as an answerback code. An answerback code contains the following:

OOOOO SHIP X

OOOOO: Coast station-assigned five-digit telex code
 SHIP: Ship name
 X: For shipboard station, normally X is entered.

The procedure for registering the answerback code is the same as which appears on page 8-1. If an answerback code was registered before the commissioning of the coast station, a new answerback code must be entered. To enter a new answerback code, contact FURUNO or an authorized FURUNO agent or dealer.

Registering scan groups

The central system emits a free-signal to indicate a coast station radio channel is in idle condition and available for ship-to-shore calls. The free-signal is detected and recognized by the shipboard equipment as a permission to start the transmission. Then, the shipboard operator initiates a call.

You can scan search for the free-signal automatically by registering coast station radio channels in scan group(s). The procedure for registering scan groups for coast station use is the same as that which appears on page 8-7.

Registering stations

The next step is to enter station name. The procedure is the same as that shown on page 8-3.

10.9.3 Commands

The tables which follows describe the commands for macro operation

Command (Prefixed with @)	Parameter	Content
CALL	S: Station Name	Calling station name and ID on assigned parameter
FREE (support command for CALL)	Two digits, 0-99 min.	Free-signal searching time according to assigned parameter (default setting: 10 min)
	\$RRR\$ signal	Detect free signal of dot pattern
RETRY (support command for CALL)	Two digits, 0-99 min.	Calling according to assigned parameter (default setting: 10 min)
CASE	Text	For receiving a message (designated by parameter) transmitted by coast station
TIMEOUT (support command for CALL)	Two digits, 0-99 min.	Time allotted for reception of message by CASE command
SEND	Text	Text transmitted according to assigned parameters
	A: file name	Send a file from floppy disk
WRU HR OVER BREAK	None	Function keys F7 – F10
DISPLAY	Text	Text of message appears
INPUT	None	Waiting for keyboard input Transmit keyboard input message

Commands processed by Danish coast station Lyngby

Command	Function
BRK+	Disconnection communications line
DIRTLX+	Direct dialing telex (receive only)
KKKK	Terminate message
LTR+	For telex letters mailed from Operations Station to destinations worldwide
MED+	Request medical advice
OPR+	Requesting operating assistance
POS+	Send position data
STA+	Status requested on a store-and-forward message
TLX+	Store-and-forward method

For details, consult the coast station's traffic manual.

10.9.4 Store-and-forward method

The following is the sequence of events in transmission of a file by the store-and-forward method.

1. Shipboard station sends message to coast station.
2. Coast station stores message in memory buffer.
3. Shipboard station and coast station clear the radio circuit.
4. Coast station sends message to subscriber designated.

Actual procedure for store-and-forward telex

<u>No.</u>	<u>Procedure</u>	<u>Display</u>	<u>Remarks</u>
1	Call a coast station.	CONNECT appears in reverse video (and bell sounds).	Free-signal found; radio circuit ready.
2	Transmit WRU signal.	00190 TLG DK 26 X X X SHIP X GA+?	Initial identity exchange between coast station and shipboard station
3	Key in subscriber's Telex number. Example: (Hong Kong) 12345		
	TLX80212345+	MSG+?	Request to start message transmission
4	Transmit file.		Message transmission
5	When transmission is completed, type KKKK.	26 X X X SHIP X 00190 TLG DK GA+?	Transmit your answerback code. Receive other party's answerback code.
6	Transmit BREAK command to clear radio circuit.		

Procedure for preparing a macrofile for store-and-forward method

You will need a macrofile to enable automatic message transmission by store-and-forward method. After preparing it, save it to a floppy disk for future use.

1. Press function key **F1** to display the File menu.
2. Press the **1** key.
3. Prepare macrofile. Below is simple example.

```

----- < [1] UNTITLED1 > -----
@FREE $RRR$ ----- ①
@CALL S:LYNGBY RADIO ----- ②
@WRU
@CASE GA+?
@SEND TLX80212345+ ----- ③
@CASE MSG+?
@SEND A:\ABC ----- ④
@SEND KKKK ----- ⑤
@CASE GA+?
@SEND BRK+
    
```

- ① Search dot pattern free signal until it is found
- ② Station name (Example: LYNGBY RADIO)
Who are you?
Station identity exchange
- ③ Subscriber's Telex number (in example, 802 is country code of Hong Kong) for store-and-forward method
- ④ Location and name of file message
A:\ABC
- ⑤ Request for termination of message

Sample macrofile for store-and-forward method

4. Press function key **F1** to display the File menu.
5. Press the **3** key. The Close Text appears on the display.

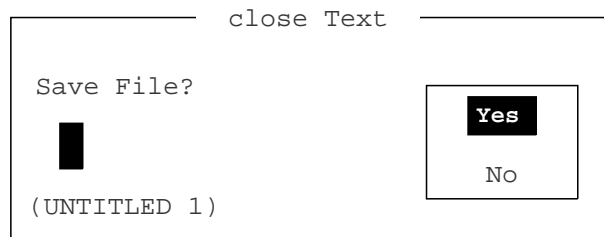

Close text prompt

6. Press the **Enter** key and enter a file name as follows:

OOOOOOOO.MCR

↑ ↑

File Name Extension Name

(max. 8 characters)

7. Press the **Enter** key.

DIRTLX macrofile

Sample DIRTLX macrofile

@FREE \$RRR\$	-----	①
@CALL S: LYNGBY RADIO	-----	②
@WRU		
@CASE GA+?		
@SEND DIRTLX725644325+	-----	③
@CASE MSG+?		
@SEND A: \ABC	-----	④
@SEND KKKK	-----	⑤
@CASE GA+?		
@SEND BRK+		

- ① Search dot pattern free signal until it is found
- ② Station name (Example: LYNGBY RADIO)
Who are you?
Station identity exchange
- ③ Subscriber's Telex number (in example, 72 is country code of JAPAN) for direct dialing mode
- ④ Location and name of file message
A: \ABC
- ⑤ Request for termination of message

Sample DIRTLX macrofile

Procedure for DIRTLX

<u>No.</u>	<u>Procedure</u>	<u>Display</u>	<u>Remarks</u>
1	Call a coast station.	CONNECT appears in reverse video (and bell sounds).	Free-signal found; radio circuit ready.
2	Transmit WRU signal.	00190 TLG DK 26 X X X SHIP X GA+?	Initial identity exchange between coast station and shipboard station
3	Key in subscriber's Telex number. Example: (Japan) 5644325		
	DIRTLX725644325+	12:20 MOM 5644325 FURUNO J MSG+	Request to start message transmission
4	Transmit file.		Message transmission
5	When transmission is completed, type KKKK.	26 X X X SHIP X 5644325 FURUNO J 00190 TLG DK DURATION ... TIME ... GA+?	Transmit your answerback code. Receive other party's answerback code.
6	Transmit BREAK command to clear radio circuit.		

10.10 Automatic Telex using Macrofile

This section describes how to transmit a telex message using a macrofile.

Basic procedure

1. Register answerback code (Telex number assigned by coast station).
2. Register coast station frequency and channel to scan group.
3. Register station name including scan group name.
4. Retrieve appropriate macrofile. Include station name and message file name. Type message and save file to memory.
5. Open macro operation menu and select a macrofile. Your message will be transmitted automatically. Below is the sequence of automatic message transmission to a coast station.
6. Search for free-signal
7. Call coast station on one of its radio channels
8. After connection is established, identity exchange
9. Transmission of service category and subscriber's address
10. Transmission of message
11. Transmission of termination of message signal
 - a) Identity exchange
 - b) Clearing of radio circuit

Actual procedure

1. Press function key **F3** to display the Operate menu.

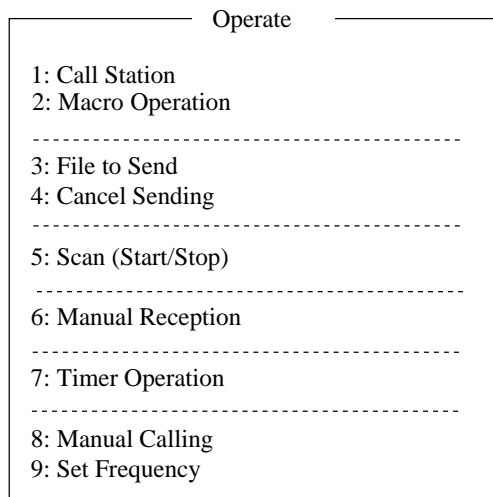

Operate menu

2. Press the **2** key to display the Call Macro screen.

10. NBDP TRANSMITTING, RECEIVING

```
Call Macro
[A:\TEST1. ]
-----File name-----Size-----Date & Time-----
LYNGBY1.MCR          169      02-10-13 06:23
[-----End of Directory-----]

1 Files exist          1454000 bytes free

To select : ENTER  To view : SPACE  To quit : ESC
```

Call macro screen

3. Press the ↓ key to choose a macrofile.
4. Press the **Enter** key.

```
Call Macro: Lyngby1.MCR
Call OK?  Yes  No
```

Press the **Enter** key to confirm the macrofile selected. The Wait for Free Signal indication appears. Your message will be transmitted automatically.

11. MAINTENANCE & TROUBLESHOOTING

WARNING

ELECTRICAL SHOCK HAZARD
Do not open the equipment.

Only qualified personnel should work inside the equipment.

NOTICE

Do not apply paint, anti-corrosive sealant or contact spray to coating or plastic parts of the equipment.

Those items contain organic solvents that can damage coating and plastic parts, especially plastic connectors.

11.1 Radiotelephone Test

Do the following to check the radiotelephone for proper operation.

- At the RT or Scan screen, press the **3/TEST** key to show the following window.

Which test do you carry out?

CANCEL DAILY SELF CHECK

- For the self check, select SELF CHECK and push the **ENTER** knob to start the test. OK or NG (No Good) appears as the test result for each item checked. For NG, contact your dealer for advice.

Tx selfcheck

PLL : OK	
RF : OK	TX FIL : OK
PA : OK	COUPL : OK

(FS-1570)

Tx selfcheck

PLL : OK	RF : OK
PA1 : OK	PA2 : OK
COMB : OK	COUPL : OK
TX FIL : OK	

(FS-2570)

Tx selfcheck

PLL : OK	RF : OK
PA1 : OK	PA2 : OK
PA3 : OK	PA4 : OK
COMB1 : OK	COMB2 : OK
COMB : OK	COUPL : OK
TX FIL : OK	

(FS-5070)

- Press the **CANCEL** key to quit the test and return to the previously used screen.
- Set the RX frequency to "2182.00 kHz". (See "2.2 Choosing Channel, Frequency".)
- Select DAILY and push the **ENTER** knob to show the Daily test display. After several seconds, the test shows results.

Daily test

JUL-26-2006-18:10

MAIN	: 0550225-01
PANEL 1	: 0550222-01
PANEL 2	: 0550222-01
DSC	: 0550207-01
NBDP	: 0550208-01

Rotate the **ENTER** knob.

Daily test

▲ RCVR1	: OK*
RCVR2	: OK*
TRX	: OK*

RCVR1, RCVR2, TRX:
Printed circuit board

*: If "NG", ask your dealer.

- When the RCVR1, RCVR2 and TRX are indicated "OK", go to the step 8. If "NG" (No Good) appears, go to the next step.
- Set the channel used for the SSB to "200". (See "2.2 Choosing Channel, Frequency".)

11. MAINTENANCE & TROUBLESHOOTING

8. Follow the step 4 and retry the Daily test.

Confirm the RCVR1, RCVR2 and TRX are indicated "OK". If "NG" (No Good) appears again, ask your dealer.

9. Press the **CANCEL** key to close the test screen.

11.2 Maintenance

Regular maintenance is vital for maintaining performance. Following the procedures below will help keep the equipment in top operating condition.

Maintenance check points

Item	Check Point	Remedy/Remarks
Antenna	Check for physical damage and corrosion.	Replace damaged parts.
Wire antenna	Check that the antenna is properly spanned and separated sufficiently from metallic structures.	If necessary, re-span antenna.
Insulators for antenna	Check for salt water deposits on insulators. Check that connection at the lead-in insulator is tight and rust-free.	Replace damage insulators. Remove salt water deposits. Clean with fresh water, then dry. Remove rust, then tighten bolts and lock nuts. Cover metallic surface with sealing compound.
Antenna coupler	<ul style="list-style-type: none"> • Check condition of antenna terminal, ground, coaxial cable and control cable. • Check that coupler lid and cable glands are firmly secure. Check for physical damage, corrosion and salt water deposits. 	<ul style="list-style-type: none"> • Tighten loosened connections. • Fasten lid firmly and evenly to prevent water leakage. • Replace if damaged.
Control unit	<ul style="list-style-type: none"> • Check ground connection, control cable, and external equipment. Confirm that there are no objects on the top of the control unit. • Remove dust from control unit with soft cloth. <p>Note: Do not use chemical cleaners to clean the control unit; they can remove paint or markings or deform the equipment.</p>	<ul style="list-style-type: none"> • Tighten loosened connections; remove foreign material from connectors. • Remove any objects. • Wipe the LCD carefully to prevent scratching, using tissue paper and an LCD cleaner. To remove dirt or salt deposits, use an LCD cleaner, wiping slowly with tissue paper so as to dissolve the dirt or salt. Change paper frequently so the salt or dirt will not scratch the LCD.
Transceiver unit	<ul style="list-style-type: none"> • Check connection at signal cable, coaxial cable, control cable, power cable, and navigator. • Confirm that there are no objects on the top of the cabinet. 	<ul style="list-style-type: none"> • Tighten loosened connections; remove foreign material from connectors. • Remove any objects.
Power supply	<ul style="list-style-type: none"> • Check that the supply voltage at transmission is within the rated range (21.6 to 31.2 VDC at the power connector). 	<ul style="list-style-type: none"> • If not within the range, check ship's mains or ship's battery. Low voltage may cause erratic operation.

11.3 Simple Troubleshooting

The table below provides possible problems and the means with which to restore normal operation. If normal operation cannot be restored, do not attempt to check inside the equipment. Any servicing should be referred to a qualified technician.

Problem	Probable cause	Remedy
Power cannot be turned on.	<ul style="list-style-type: none"> • Mains switchboard may be off. • (DC) voltage is too high. • Battery may have discharged, or poor contact at terminals. 	<ul style="list-style-type: none"> • Turn on the mains switchboard. • Check supply voltage. • Recharge battery and tighten battery terminals.
Display indications do not appear but key lamps are lit.	<ul style="list-style-type: none"> • Contrast is too low. 	<ul style="list-style-type: none"> • Operate the 9/☼ key to adjust contrast.
Power is on but no sound from loudspeaker.	<ul style="list-style-type: none"> • Loudspeaker is off. 	<ul style="list-style-type: none"> • Operate the 7/🔊 key to turn on the loudspeaker.
Poor articulation	<ul style="list-style-type: none"> • Wrong class of emission may be in use. 	<ul style="list-style-type: none"> • Class of emission should match that of incoming signal.
Output power reduced to LOW	<ul style="list-style-type: none"> • Power is automatically reduced to protect against overheating due to continuous transmission. 	<ul style="list-style-type: none"> • Wait until the unit returns to normal condition.
Antenna coupler cannot tune antenna	<ul style="list-style-type: none"> • Antenna may be disconnected or shorted to ground. • Antenna is out of tunable length. • Poor grounding of antenna coupler. • Breaker in coupler has tripped. • Connection cable loosened or disconnected. 	<ul style="list-style-type: none"> • Check antenna connection. • Recommended length is 10 to 18 meters. • Check coupler ground. • Checks mains voltage and polarity. If normal, reset breaker. • Check cable.
The message "Ship's mains failure" appears, and Output power indicator blinks. Transmission power is decreased to LOW2. (FS-5070 only)	<ul style="list-style-type: none"> • Input has been switched from AC to DC when AC FAIL line of AC/DC power supply unit PR-850A is connected to FS-5070. 	<ul style="list-style-type: none"> • Press the CANCEL key. The output power can be increased on the RT display. Note that the output power remains "HIGH" when it occurs while sending the distress call. When AC power is restored, this problem is automatically resolved.
After turning on the power, the initial screen appears continuously. (The RT screen should appear after the initial screen is erased.)	<ul style="list-style-type: none"> • After turning on the NBDP terminal unit, you have turned on the control unit. 	<ul style="list-style-type: none"> • Turn on the control unit before turning on the NBDP terminal unit.

11.4 Error Messages

The table below shows error messages, their meanings, and remedies. If other error occurs, contact your dealer.

Error messages

Error message	Meaning	Remedy
Busy: RT	Radiotelephone is in operation.	Wait until the radiotelephone is free.
Channel Busy	You attempted to transmit on a channel which is currently busy. (This occurs with Routine and Business priorities only.)	The message is automatically erased when the channel becomes clear.
EPFS error	No position data from navigator for one minute.	Press the CANCEL key to silence the alarm. Check the navigator. If it is malfunctioning, manually enter position.
Incoming	Incoming DSC call	Message is automatically cleared when DSC signal has gone.
No position data	The position data is interrupted while AUTO operation.	Check the navigator.
No response: RT	Radiotelephone is not powered or is disconnected.	Check radiotelephone connection.
Oven cold. Tx not ready; wait	Oven too cold; cannot transmit.	Wait until the oven becomes sufficiently warm.
Printer not ready	Automatic print is selected; however, printer is not powered or is disconnected.	Check printer.
Trouble: Oven not ready	Oven not ready; cannot transmit.	Wait until the oven is ready.
TRX PLL UNLOCK	TRX PLL unlock. Transmission is stopped.	Contact your dealer.
TUNE error	Tuning failed. Transmission power is decreased to LOW2. For NBDP, transmission is stopped.	Try to tune again. If unsuccessful, confirm if TUNE error occurs on other frequencies. See "Antenna coupler cannot tune antenna" on page 11-3, or contact your dealer.
Warning: Update position	Position data is older by the amount of time preset on the Alarm menu.	Press the CANCEL key to silence alarm. Reenter position on the Position menu.
Watchdog error. Please Power OFF	Internal error (such as CPU trouble) detected. Accompanied with alarm, same type as for distress.	Turn the power off and on to erase the message. Have a qualified technician check the set.
RX1 PLL UNLOCK RX2 PLL UNLOCK	W/R1, W/R2 PLL unlock. Transmission is stopped.	Contact your dealer.
Ship's mains failure	Power input has been switched from AC to DC at PR-850A.	Press the CANCEL key to use the low output power. Check the AC input supply.

11.5 Replacement of Fuses

To protect the equipment from overcurrent and equipment fault, two fuses are provided in the PR-300 Power Supply Unit. If a fuse blows, find the cause before replacing it. If it blows again after replacement, request service.

WARNING

Use the proper fuse.

Use of a wrong fuse can cause fire or damage to the equipment.

Unit	Fuse
Power Supply Unit PR-300	10 A (100 VAC) or 5 A (200 VAC) and 20 A (24 VDC)

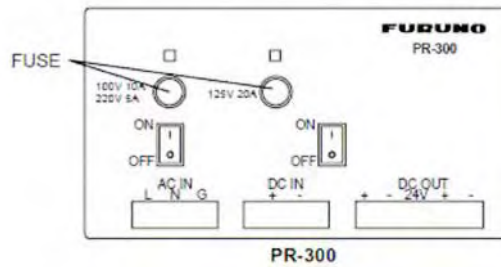

Note: The Power Supply Unit PR-850A (for FS-1570/2570), used with the equipment, does not have a fuse but a circuit breaker. If the breaker has tripped, find the reason before resetting the breaker (upward position).

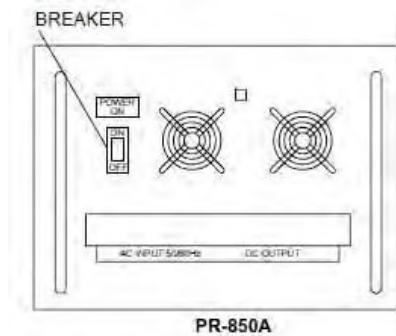

11.6 Test Call

This function sends a test signal to a coast or ship station, over one of six distress and safety frequencies. For that reason, it should not be executed unnecessarily. You can prepare a test call beforehand (see Chapter 6) or at the moment you intend to send a test call. To send a prepared test call, see paragraph 6.5.4 for the procedure. When sending the test call at the moment, do the following.

1. Press the **2/DSC** key.

Select Message	
GENERAL	DISTRESS
INDIVIDUAL	RELAY AREA
PSTN MESSAGE	RELAY COAST
TEST MESSAGE	DISTRESS
GROUP MESSAGE	
AREA MESSAGE	SPECIAL
POSITION	
MMSI 123456789	UTC 01:53
POS 12°34.5678N	EPFS 01:54
123°45.6789E	

2. Rotate the **ENTER** knob to choose TEST MESSAGE and then push the **ENTER** knob.
3. Push the **ENTER** knob to open the STATION ID window.
4. Rotate the **ENTER** knob to choose MANUAL or SELECT.
5. **For SELECT**, you can choose an ID from the message file list stored.
6. **For MANUAL**, using the numeric keys, key in the ID of the station ID (nine digits) where to send the call and then push the **ENTER** knob.

Compose msg.	
MSG TYPE	· TEST MESSAGE
STATION ID	******
PRIORITY	: SAFETY
DSC FREQ	: 2187.5 kHz
GO TO VIEW	

7. Push the **ENTER** knob to open the DSC FREQ menu. (Note that PRIORITY is automatically selected to SAFETY.)

Compose msg.	
MSG TYPE	2187.5
STATION ID	4207.5
PRIORITY	6312.0
	8414.5
	12577.0
	16804.5
DSC FREQ	kHz
GO TO VIEW	

8. Rotate the **ENTER** knob to choose an appropriate frequency and then push the **ENTER** knob. The display changes as below.

Compose msg.	
MSG TYPE	: TEST MESSAGE
STATION ID	: 001234567
PRIORITY	: SAFETY
DSC FREQ : 2187.5 kHz	
GO TO VIEW	

9. Press the **CALL** key to send the test call (transmission time: about seven seconds).
 10. The display shows "Test message in progress!" while the test call is being transmitted.

Test message in progress!	
DESTINATION ID	: 001234567
PRIORITY	: SAFETY
DSC FREQ : 2187.5 kHz	
TIME TO GO	: 7S

After the test call is completed, the following message appears.

Waiting for test acknowledgement.	
DESTINATION ID	: 001234567
PRIORITY	: SAFETY
DSC FREQ : 2187.5 kHz	
TIME TO GO : 4M12S RESENDING	

One of the following displays appears. ("No response! Try calling again?" appears when the timer counts down to zero, meaning no response from station.)

Test acknowledge message received.	
CANCEL: STOP ALARM	

Test acknowledge received

No response! Try calling again?	
DESTINATION ID:	001234567
PRIORITY:	SAFETY
DSC FREQ : 2187.5 kHz	
RESEND	

No response to test call

11. Do the either way depending on the message shown in step 10.

Test acknowledge message received

The audio alarm sounds; press the **CANCEL** key to silence the alarm. The display changes as below.



No response! Try calling again?

Re-send call: Push the **ENTER** knob and then press the **CALL** key.

Cancel call: Press the **CANCEL** key to return to the previous screen.

11.7 NBDP Terminal Unit Maintenance

Regular maintenance is important for good performance. A regular maintenance program should be established and should at least include the items mentioned below.

11.7.1 Cleaning the equipment

Wipe off accumulated dust from the terminal unit with a soft cloth. Wipe the LCD carefully to prevent scratching, using tissue paper and an LCD cleaner. To remove dirt or salt deposits, use an LCD cleaner, wiping slowly with tissue paper so as to dissolve the dirt or salt. Change paper frequently so the salt or dirt will not scratch the surface of LCD. Do not use solvents such as thinner, acetone or benzene for cleaning; they can remove paint and marks or deform the equipment.

11.7.2 Connectors and earth connection

Periodically check the connectors for proper seating and the earth connection for rust. Remove rust to maintain a good ground system.

11.7.3 Floppy disk drive

Foreign material on the floppy disk drive head can scratch the magnetic material in the floppy, resulting in loss of data. Clean the floppy disk drive head regularly with a floppy disk drive cleaning disk to prevent erasure of information stored on disks.

11.7.4 Diagnostics

General diagnostics

1. Press the function key **F6** to display the System menu.

System	
Setup	Lock Change Default
Slave Delay	8 msec (0- 50 msec)
TX/RX MSG Save	OFF ON
Edit Before sending	OFF ON
Time System	OFF UTC SMT JST
Time & Date	2006/10/16 10:00:00
Window Color	
Self Test	

System menu (Example: IB-583)

2. Choose Change from Setup.
3. Choose Self Test (at the bottom of the screen).
4. Press the **Esc** key. The results of the self test are displayed a short time later.

Selftest		
Terminal Unit Test	: ver. X.XX :OK	← IB-581/IB-583
Main Unit Test	: ver. XX :OK	← Main Termina soft (T-CPU Board)
Modem Unit Test	: ver. XX :OK	← NBDP Modem
Radio Unit Test	: ID FS5070 :OK	
DSC Unit Test	: ID FS5070 :OK	
Printer Unit Test*	: Print all character :OK	

X.XX = Version No.

*: "NG" and "Printer not ready" when printer is off or is abnormal.

Self test results

The test results are shown as OK or NG (No Good). For any NG, try the self test again. If it appears again, call for service. When the test is completed, the message "Selftest Completed. Press any key to escape." Appears.

Tone test

1. Choose Self Test from the System Menu.
2. While pressing and holding down the **Shift** key, press the ↓ key to show the Tone Test menu.

Tone Test	
1:	Tone Test 1 (All Char)
2:	Tone Test 2 (Fox)
3:	Tone Test 3 (Beta)

3. Choose a test and press the **Enter** key.
4. You may stop a tone test at anytime by pressing the **Esc** key.

Tone test 1 (All characters)

This test checks for proper transmission of all figures, letters and codes. To conduct the test, call a station in the ARQ or FEC mode. Execute the test, confirming that all characters are transmitted correctly. "Now Testing Tone Test 1" appears during the testing. Since the test is conducted continuously, you may press the **Esc** key twice followed by the **F10** key to stop the test and return to the tone test menu.

```

1:File 2:Edit 3:Operate 4:Window 5:Station 6:System 7:WRU 8:HR 9:Over 10:Break
-----
Station Name      :                               Setup          Lock   Change   Default
Frequency (T/R)  :                               -----
Comm Status      :   Connect Sen
-----
    
```

Now Testing Tone Test 1 (All Char).

ABCDEFGHIJKLMNOPQRSTUVWXYZ1234567890-?:()., '=/+abcdefghijklmnopqrstuv
wxyz

ABCDEFGHIJKLMNOPQRSTUVWXYZ1234567890-?:()., '=/+abcdefghijklmnopqrstuv
wxyz

ABCDEFGHIJKLMNOPQRSTUVWXYZ

Tone test 2 (Fox)

This test (continuously) checks for proper transmission of the test message THE QUICK BROWN FOX JUMPS OVER THE LAZY DOG 0123456789. To conduct the test, call a station by using the ARQ or FEC mode.

Tone test 3 (Beta)

You may check for proper transmission of the idle signal β. Call up a station using the ARQ mode.

11.7.5 Notification messages

IB-583

Notification message	Meaning	Remedy
Caution: This Editor cannot edit over 16Kbytes	Can not edit the files over 16 kilobytes.	Can not open the files over 16 kilobytes. Delete unnecessary characters so that the file size is less than 16 kilobytes.
Station by that name already exists.	The station name already exists.	Change the station name.
Station memory is full.	The station memory is full.	Delete unnecessary stations.
Scan group by that name already exists.	The scan group name already exists.	Change the scan group name.
Scan group by that name does not exist.	The scan group name does not exist.	Check the scan group name.
Scan group memory is full.	The scan group memory is full.	Delete unnecessary scan groups.
Channel by that number does not exist.	The channel number does not exist.	Check the channel number.
Operation name already exists.	The timer operation name already exists.	Change the timer operation name.
Timer operation memory is full.	The timer operation memory is full.	Delete unnecessary timer operations.
Drive not ready.	The floppy disk is not correctly inserted.	Check if the floppy disk is correctly inserted.
Write protect error.	You tried to write over a file when the disk is write protected.	To write over the file, put the write-protect switch in write-enable position and try again. If you do not want to write over the file, insert another floppy disk and try again.
Floppy Disk Format failed.	A floppy disk could not be formatted.	Check the disk.
File not found. '[file name]'	The file name could not be found.	Check the file name.
Disk full.	The floppy disk is full.	Change the floppy disk or delete unnecessary files.

11. MAINTENANCE & TROUBLESHOOTING

<p>Check interconnection between terminal and Main.</p>	<p>There is a problem with the connection between the terminal unit and the transceiver unit. (The transceiver unit is off or is not connected.)</p>	<p>Check if the transceiver unit is on. Check the connection between the terminal unit and the transceiver unit. Then do the following; 1. Turn off the terminal unit and the transceiver unit. 2. Turn on the transceiver unit. 3. When the RT screen appears on the transceiver unit, turn on the terminal unit.</p>
<p>Cannot print. Check connection between printer and terminal.</p>	<p>You tried to print but something is wrong with the printer.</p>	<p>Check if the printer is on. Check the connection between the printer and the terminal unit. Check the remaining amount of the roll paper.</p>
<p>Selected file is not macro.</p>	<p>The selected file is not a macro file.</p>	<p>Select a file with ".mcr" extension.</p>
<p>Macro command error.</p>	<p>The macro command is illegal.</p>	<p>Check the macro command.</p>
<p>Wait one minute before calling again after failed.</p>	<p>If a call could not be made, wait a minute before calling again. In the ARQ mode the line is automatically disconnected when there is no reply from the called party. Wait one minute then try the call again.</p>	<p>-</p>

APPENDIX

Menu Tree

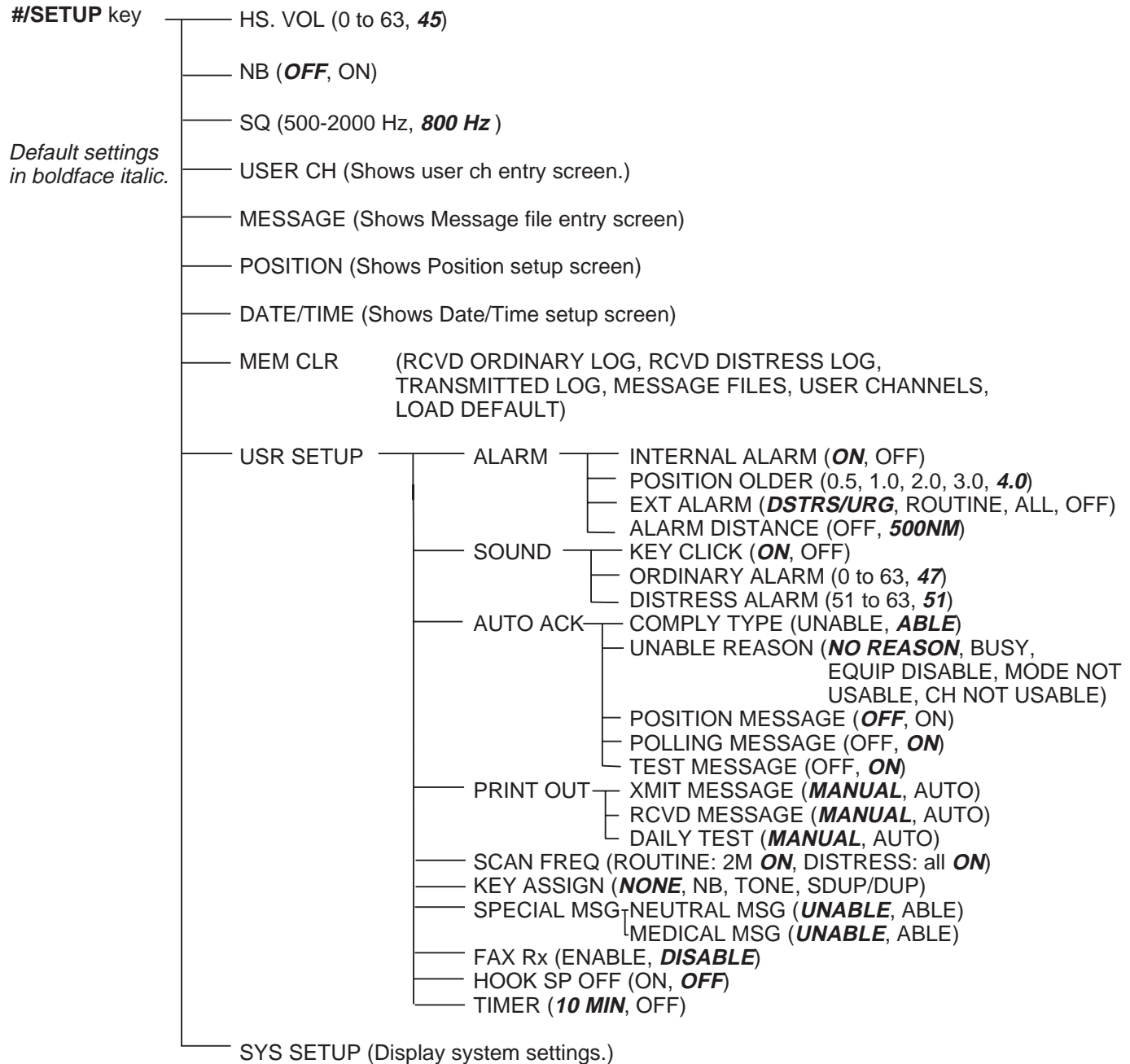

NBDP terminal unit (telex)

Default settings in boldface italic.

F1: File

- 1: New
- 2: Open
- 3: Close
- 4: Delete
- 5: Rename
- 6: Real Time Printing
- 7: File to Print
- 8: Cancel Printing
- 9: Clear Buffer
- 0: Floppy Disk Format

F5: Station

- 1: Station Entry
- 2: Timer Operation Entry
- 3: Scan Entry
- 4: User Channel Entry
- 5: Answerback Code Entry
- 6: Group ID Entry (4/5 digit)
- 7: Group ID Entry (9 digit)
- 8: Select ID Entry (4/5 digit)
- 9: Select ID Entry (9 digit)

F2: Edit

- 1: Undo
- 2: Cut
- 3: Copy
- 4: Paste
- 5: Select All
- 6: Search
- 7: Replace
- 8: Goto Top
- 9: Goto Bottom
- 0: Goto Line
- A: Change Text

F3: Operate

- 1: Call Station
- 2: Macro Operation
- 3: File to Send
- 4: Cancel Sending
- 5: Scan (Start/Stop)
- 6: Manual Reception
- 7: Timer Operation
- 8: Manual Calling
- 9: Set Frequency

F4: Window

- 1: Calendar
- 2: Distress Frequency Table

F6: System

- Setup (**Lock**, Change, Default)
 - Slave Delay (0-50 msec, **8**)
 - TX/RX MSG Save (**OFF**, ON)
 - Edit Before Sending (**OFF**, ON)
 - Time System (OFF, **UTC**, SMT, JST)
 - Time & Date
 - Display Mode (IB-581) (**Normal**, Reverse)
 - Window Color (IB-583)
 - Window Color Setup
 - Window
 - Fore Color
 - Back Color
 - Default Color
 - Self Test
- BASE WINDOW, BACK SCROLL,
EDIT 1-2, FUNCTION, SUB MENU 1-3,
MESSAGE
L-WHITE, YELLOW,
L-MAGENTA, L-RED,
L-CYAN, L-GREEN,
L-BLUE, GRAY,
WHITE, BROWN,
MAGENTA, RED,
CYAN, GREEN,
BLUE, BLACK

F7: WRU (Who are you?)

F8: HR (Here is)

F9: Over

F10: Break

Frequency Tables

DSC frequency table

TX (kHz)	RX (kHz)	Remarks	File Name
2187.5	2187.5	Distress and Safety Frequencies	
4207.5	4207.5		
6312.0	6312.0		
8414.5	8414.5		
12577.0	12577.0		
16804.5	16804.5		
458.5	455.5	International Frequencies	INTL-0.4M
2189.5(2177.0*)	2177.0		INTL-2M
4208.0	4219.5		INTL-4M
6312.5	6331.0		INTL-6M
8415.0	8436.5		INTL-8M
12577.5	12657.0		INTL-12M
16805.0	16903.0		INTL-16M
18898.5	19703.5		INTL-18M
22374.5	22444.0		INTL-22M
25208.5	26121.0		INTL-25M
4208.5	4220.0	Local-1 Frequencies	LOCAL1-4M
6313.0	6331.5		LOCAL1-6M
8415.5	8437.0		LOCAL1-8M
12578.0	12657.5		LOCAL1-12M
16805.5	16903.5		LOCAL1-16M
18899.0	19704.0		LOCAL1-18M
22375.0	22444.5		LOCAL1-22M
25209.0	26121.5		LOCAL1-25M
4209.0	4220.5	Local-2 Frequencies	LOCAL2-4M
6313.5	6332.0		LOCAL2-6M
8416.0	8437.5		LOCAL2-8M
12578.5	12658.0		LOCAL2-12M
16806.0	16904.0		LOCAL2-16M
18899.5	19704.5		LOCAL2-18M
22375.5	22445.0		LOCAL2-22M
25209.5	26122.0		LOCAL2-25M

14. = Ship-to-ship

MF band working carrier frequencies (ref. US CFR 47 Part 80.371)

Region	Ship Transmit (kHz)	Ship Receive (kHz)	Region	Ship Transmit (kHz)	Ship Receive (kHz)
East Coast	2031.5	2490.0	Gulf Coast	2009.0	2466.0
	2118.0	2514.0		2134.0	2530.0
	2126.0	2522.0		2142.0	2538.0
	2142.0	2538.0		2158.0 ¹	2550.0
	2166.0	2558.0		2166.0	2558.0
	2198.0	2590.0		2206.0	2598.0
	2366.0	2450.0		2366.0	2450.0
	2382.0	2482.0		2382.0	2482.0
	2390.0	2566.0		2430.0	2572.0
	2400.0	2400.0		2458.0	2506.0
	2406.0	2506.0			
West Coast	2003.0	2450.0	Great Lakes ²	2118.0	2514.0
	2009.0	2442.0		2158.0	2550.0
	2009.0	2566.0		2206.0	2582.0
	2031.5	2566.0	Alaska	2131.0	2309.0
	2126.0	2522.0		2134.0	2312.0
	2206.0	2598.0		2240.0	2400.0
	2382.0	2466.0	Hawaii	2134.0	2530.0
	2430.0	2482.0	Caribbean	2009.0	2506.0
				2086.0 ³	2585.0
				2134.0	2530.0
			Guam	2009.0	2506.0

Above frequencies are not programmed. Contact a FURUNO representative.

1 = Unlimited use December 15 to April 1

2 = 2206 kHz for distress only

3 = Limited to pep of 150 W.

MF band SSB working carrier frequencies

CH NO	Ship Receive (kHz)	Ship Transmit (kHz)	CH NO	Ship Receive (kHz)	Ship Transmit (kHz)
241	1635	2060	271	1725	2069
242	1638	2063	272	1728	2072
243	1641	2066	273	1731	2075
244	1644	2069	274	1734	2078
245	1647	2072	275	1737	2081
246	1650	2075	276	1740	2084
247	1653	2078	277	1743	2087
248	1656	2081	278	1746	2090
249	1659	2084	279	1749	2093
250	1662	2087	280	1752	2096
251	1665	2090	281	1755	2099
252	1668	2093	282	1758	2102
253	1671	2096	283	1761	2105
254	1674	2099	284	1764	2108
255	1677	2102	285	1767	2111
256	1680	2105	286	1770	2114
257	1683	2108	287	1773	2117
258	1686	2111	288	1776	2120
259	1689	2114	289	1779	2123
260	1692	2117	290	1782	2126
261	1695	2120	291	1785	2129
262	1698	2123	292	1788	2132
263	1701	2126	293	1791	2135
264	1704	2129	294	1794	2138
265	1707	2132	295	1797	2060
266	1710	2135			
267	1713	2138			
268	1716	2060			
269	1719	2063			
270	1722	2066			

4/6 MHz ITU SSB carrier frequencies (ITU RR Appendix 16)

4 MHz SSB (J3E)		
ITU CH NO	Ship RX	Ship TX
401	4357	4065
402	4360	4068
403	4363	4071
404	4366	4074
405	4369	4077
406	4372	4080
407	4375	4083
408	4378	4086
409	4381	4089
410	4384	4092
411	4387	4095
412	4390	4098
413	4393	4101
414	4396	4104
415	4399	4107
416	4402	4110
417	4405	4113
418	4408	4116
419	4411	4119
420	4414	4122
421	4417	4125
422	4420	4128
423	4423	4131
424	4426	4134
425	4429	4137
426	4432	4140
427	4435	4143
428	4351	4351
429	4354	4354
430	4146	4146
431	4149	4149
432 (01)	4000	4000
433 (02)	4003	4003
434 (03)	4006	4006
435 (04)	4009	4009
436 (05)	4012	4012
437 (06)	4015	4015
438 (07)	4018	4018
439 (08)	4021	4021
440 (09)	4024	4024
441 (10)	4027	4027
442 (11)	4030	4030
443 (12)	4033	4033
444 (13)	4036	4036
445 (14)	4039	4039
446 (15)	4042	4042
447 (16)	4045	4045
448 (17)	4048	4048
449 (18)	4051	4051
450 (19)	4054	4054
451 (20)	4057	4057
452 (21)	4060	4060

6 MHz SSB (J3E)		
ITU CH NO	Ship RX	Ship TX
601	6501	6200
602	6504	6203
603	6507	6206
604	6510	6209
605	6513	6212
606	6516	6215
607	6519	6218
608	6522	6221
609	6224	6224
610	6227	6227
611	6230	6230

These frequencies are factory programmed.

CH NOs in () are ITU NOs (RR Section C-1).

8 MHz ITU SSB carrier frequencies (ITU RR Appendix 16)

8 MHz SSB (J3E) - Duplex			8 MHz SSB (J3E) - Simplex		
ITU CH NO	Ship RX	Ship TX	(ITU CH NO)	Ship RX	Ship TX
801	8719	8195	840 (01)	8101	8101
802	8722	8198	841 (02)	8104	8104
803	8725	8201	842 (03)	8107	8107
804	8728	8204	843 (04)	8110	8110
805	8731	8207	844 (05)	8113	8113
806	8734	8210	845 (06)	8116	8116
807	8737	8213	846 (07)	8119	8119
808	8740	8216	847 (08)	8122	8122
809	8743	8219	848 (09)	8125	8125
810	8746	8222	849 (10)	8128	8128
811	8749	8225	850 (11)	8131	8131
812	8752	8228	851 (12)	8134	8134
813	8755	8231	852 (13)	8137	8137
814	8758	8234	853 (14)	8140	8140
815	8761	8237	854 (15)	8143	8143
816	8764	8240	855 (16)	8146	8146
817	8767	8243	856 (17)	8149	8149
818	8770	8246	857 (18)	8152	8152
819	8773	8249	858 (19)	8155	8155
820	8776	8252	859 (20)	8158	8158
821	8779	8255	860 (21)	8161	8161
822	8782	8258	861 (22)	8164	8164
823	8785	8261	862 (23)	8167	8167
824	8788	8264	863 (24)	8170	8170
825	8791	8267	864 (25)	8173	8173
826	8794	8270	865 (26)	8176	8176
827	8797	8273	866 (27)	8179	8179
828	8800	8276	867 (28)	8182	8182
829	8803	8279	868 (29)	8185	8185
830	8806	8282	869 (30)	8188	8188
831	8809	8285	870 (31)	8191	8191
832	8812	8288	CH NOs in () are ITU NOs (RR Section C-1).		
833	8291	8291			
834	8707	8707			
835	8710	8710			
836	8713	8713			
837	8716	8716			
838	8294	8294			
839	8297	8297			

12/16 ITU SSB carrier frequencies (ITU RR Appendix 16)

12 MHz SSB (J3E)			16 MHz SSB (J3E)			16 MHz SSB (J3E)		
CH NO.	SHIP RX	SHIP TX	CH NO.	SHIP RX	SHIP TX	CH NO.	SHIP RX	SHIP TX
1201	13077	12230	1601	17242	16360	1651	17392	16510
1202	13080	12233	1602	17245	16363	1652	17395	16513
1203	13083	12236	1603	17248	16366	1653	17398	16516
1204	13086	12239	1604	17251	16369	1654	17401	16519
1205	13089	12242	1605	17254	16372	1655	17404	16522
1206	13092	12245	1606	17257	16375	1656	17407	16525
1207	13095	12248	1607	17260	16378	1657	16528	16528
1208	13098	12251	1608	17263	16381	1658	16531	16531
1209	13101	12254	1609	17266	16384	1659	16534	16534
1210	13104	12257	1610	17269	16387	1660	16537	16537
1211	13107	12260	1611	17272	16390	1661	16540	16540
1212	13110	12263	1612	17275	16393	1662	16543	16543
1213	13113	12266	1613	17278	16396	1663	16546	16546
1214	13116	12269	1614	17281	16399			
1215	13119	12272	1615	17284	16402			
1216	13122	12275	1616	17287	16405			
1217	13125	12278	1617	17290	16408			
1218	13128	12281	1618	17293	16411			
1219	13131	12284	1619	17296	16414			
1220	13134	12287	1620	17299	16417			
1221	13137	12290	1621	17302	16420			
1222	13140	12293	1622	17305	16423			
1223	13143	12296	1623	17308	16426			
1224	13146	12299	1624	17311	16429			
1225	13149	12302	1625	17314	16432			
1226	13152	12305	1626	17317	16435			
1227	13155	12308	1627	17320	16438			
1228	13158	12311	1628	17323	16441			
1229	13161	12314	1629	17326	16444			
1230	13164	12317	1630	17329	16447			
1231	13167	12320	1631	17332	16450			
1232	13170	12323	1632	17335	16453			
1233	13173	12326	1633	17338	16456			
1234	13176	12329	1634	17341	16459			
1235	13179	12332	1635	17344	16462			
1236	13182	12335	1636	17347	16465			
1237	13185	12338	1637	17350	16468			
1238	13188	12341	1638	17353	16471			
1239	13191	12344	1639	17356	16474			
1240	13194	12347	1640	17359	16477			
1241	13197	12350	1641	17362	16480			
1242	12353	12353	1642	17365	16483			
1243	12356	12356	1643	17368	16486			
1244	12359	12359	1644	17371	16489			
1245	12362	12362	1645	17374	16492			
1246	12365	12365	1646	17377	16495			
			1647	17380	16498			
			1648	17383	16501			
			1649	17386	16504			
			1650	17389	16507			

Above is factory programmed.

18/19, 22, 25/26 ITU SSB carrier frequencies (ITU RR Appendix 16)

18/19 MHz SSB (J3E)			22 MHz SSB (J3E)			22 MHz SSB (J3E)		
CH NO.	SHIP RX	SHIP TX	CH NO.	SHIP RX	SHIP TX	CH NO.	SHIP RX	SHIP TX
1801	19755	18780	2201	22696	22000	2251	22846	22150
1802	19758	18783	2202	22699	22003	2252	22849	22153
1803	19761	18786	2203	22702	22006	2253	22852	22156
1804	19764	18789	2204	22705	22009	2254	22159	22159
1805	19767	18792	2205	22708	22012	2255	22162	22162
1806	19770	18795	2206	22711	22015	2256	22165	22165
1807	19773	18798	2207	22714	22018	2257	22168	22168
1808	19776	18801	2208	22717	22021	2258	22171	22171
1809	19779	18804	2209	22720	22024	2259	22174	22174
1810	19782	18807	2210	22723	22027	2260	22177	22177
1811	19785	18810	2211	22726	22030			
1812	19788	18813	2212	22729	22033			
1813	19791	18816	2213	22732	22036			
1814	19794	18819	2214	22735	22039			
1815	19797	18822	2215	22738	22042			
1816	18825	18825	2216	22741	22045			
1817	18828	18828	2217	22744	22048			
1818	18831	18831	2218	22747	22051			
1819	18834	18834	2219	22750	22054			
1820	18837	18837	2220	22753	22057			
1821	18840	18840	2221	22756	22060			
1822	18843	18843	2222	22759	22063			
			2223	22762	22066			
			2224	22765	22069			
			2225	22768	22072			
			2226	22771	22075			
			2227	22774	22078			
			2228	22777	22081			
			2229	22780	22084			
			2230	22783	22087			
			2231	22786	22090			
			2232	22789	22093			
			2233	22792	22096			
			2234	22795	22099			
			2235	22798	22102			
			2236	22801	22105			
			2237	22804	22108			
			2238	22807	22111			
			2239	22810	22114			
			2240	22813	22117			
			2241	22816	22120			
			2242	22819	22123			
			2243	22822	22126			
			2244	22825	22129			
			2245	22828	22132			
			2246	22831	22135			
			2247	22834	22138			
			2248	22837	22141			
			2249	22840	22144			
			2250	22843	22147			

25/26 MHz SSB (J3E)		
CH NO	Ship RX	Ship TX
2501	26145	25070
2502	26148	25073
2503	26151	25076
2504	26154	25079
2505	26157	25082
2506	26160	25085
2507	26163	25088
2508	26166	25091
2509	26169	25094
2510	26172	25097
2511	25100	25100
2512	25103	25103
2513	25106	25106
2514	25109	25109
2515	25112	25112
2516	25115	25115
2517	25118	25118

MF band telex frequency table

CH NO.	Ship Transmit (NBDP, DSC)	Ship Receive (NBDP, DSC)	
2001	2142.0	1607.0	NBDP/DSC
2002	2142.5	1607.5	
2003	2143.0	1608.0	
2004	2143.5	1608.5	
2005	2144.0	1609.0	
2006	2144.5	1609.5	
2007	2145.0	1610.0	
2008	2145.5	1610.5	
2009	2146.0	1611.0	
2010	2146.5	1611.5	
2011	2147.0	1612.0	
2012	2147.5	1612.5	
2013	2148.0	1613.0	
2014	2148.5	1613.5	
2015	2149.0	1614.0	
2016	2149.5	1614.5	
2017	2150.0	1615.0	
2018	2150.5	1615.5	
2019	2151.0	1616.0	
2020	2151.5	1616.5	
2021	2152.0	1617.0	
2022	2152.5	1617.5	
2023	2153.0	1618.0	
2024	2153.5	1618.5	
2025	2154.0	1619.0	
2026	2154.5	1619.5	
2027	2155.0	1620.0	
2028	2155.5	1620.5	
2029	2156.0	1621.0	
2030	2156.5	1621.5	
2031	2157.0	1622.0	
2032	2157.5	1622.5	
2033	2158.0	1623.0	
2034	2158.5	1623.5	
2035	2159.0	1624.0	
2036	2159.5	1624.5	

ITU Telex frequency table (2/4)

ITU TELEX FREQUENCY TABLE (2/4)

FURUNO

4 MHz BAND		6 MHz BAND		8 MHz BAND		12 MHz BAND		16 MHz BAND		18/19 MHz BAND		22 MHz BAND		25/26 MHz BAND	
No.	TX	No.	TX	No.	TX	No.	TX	No.	TX	No.	TX	No.	TX	No.	TX
8066	8409.0	12066	12509.5	12612.0	16066	16716.0	16639.0	22066	22317.0	22409.0	25066	25205.5	25205.5		
8067	8409.5	12067	12510.0	12612.5	16067	16716.5	16639.5	22067	22317.5	22410.0	25067	25206.0	25206.0		
8068	8410.0	12068	12510.5	12613.0	16068	16717.0	16640.0	22068	22318.0	22410.0	25068	25206.5	25206.5		
8069	8410.5	12069	12511.0	12613.5	16069	16717.5	16640.5	22069	22318.5	22410.5	25069	25207.0	25207.0		
8070	8411.0	12070	12511.5	12614.0	16070	16718.0	16641.0	22070	22319.0	22411.0	25070	25207.5	25207.5		
8071	8411.5	12071	12512.0	12614.5	16071	16718.5	16641.5	22071	22319.5	22411.5	25071	25208.0	25208.0		
8072	8412.0	12072	12512.5	12615.0	16072	16719.0	16642.0	22072	22320.0	22412.0	25072	25208.5	25208.5		
8073	8412.5	12073	12513.0	12615.5	16073	16719.5	16642.5	22073	22320.5	22412.5	25073	25209.0	25209.0		
7074	8413.0	12074	12513.5	12616.0	16074	16720.0	16643.0	22074	22321.0	22413.0	25074	25209.5	25209.5		
8075	8413.5	12075	12514.0	12616.5	16075	16720.5	16643.5	22075	22321.5	22413.5					
8076	8414.0	12076	12514.5	12617.0	16076	16721.0	16644.0	22076	22322.0	22414.0					
8077	8414.5	12077	12515.0	12617.5	16077	16721.5	16644.5	22077	22322.5	22414.5					
8078	8415.0	12078	12515.5	12618.0	16078	16722.0	16645.0	22078	22323.0	22415.0					
8079	8415.5	12079	12516.0	12618.5	16079	16722.5	16645.5	22079	22323.5	22415.5					
8080	8416.0	12080	12516.5	12619.0	16080	16723.0	16646.0	22080	22324.0	22416.0					
		12081	12517.0	12619.5	16081	16723.5	16646.5	22081	22324.5	22416.5					
		12082	12517.5	12620.0	16082	16724.0	16647.0	22082	22325.0	22417.0					
		12083	12518.0	12620.5	16083	16724.5	16647.5	22083	22325.5	22417.5					
12084	12518.5	12621.0	16084	16725.0	16648.0	16725.0	16648.0	22084	22326.0	22418.0					
12085	12519.0	12621.5	16085	16725.5	16648.5	16725.5	16648.5	22085	22326.5	22418.5					
12086	12519.5	12622.0	16086	16726.0	16649.0	16726.0	16649.0	22086	22327.0	22419.0					
12087	12520.0	12622.5	16087	16726.5	16649.5	16726.5	16649.5	22087	22327.5	22419.5					
12088	12520.5	12623.0	16088	16727.0	16650.0	16727.0	16650.0	22088	22328.0	22420.0					
12089	12521.0	12623.5	16089	16727.5	16650.5	16727.5	16650.5	22089	22328.5	22420.5					
12090	12521.5	12624.0	16090	16728.0	16651.0	16728.0	16651.0	22090	22329.0	22421.0					
12091	12522.0	12624.5	16091	16728.5	16651.5	16728.5	16651.5	22091	22329.5	22421.5					
12092	12522.5	12625.0	16092	16729.0	16652.0	16729.0	16652.0	22092	22330.0	22422.0					
12093	12523.0	12625.5	16093	16729.5	16652.5	16729.5	16652.5	22093	22330.5	22422.5					
12094	12523.5	12626.0	16094	16730.0	16653.0	16730.0	16653.0	22094	22331.0	22423.0					
12095	12524.0	12626.5	16095	16730.5	16653.5	16730.5	16653.5	22095	22331.5	22423.5					
12096	12524.5	12627.0	16096	16731.0	16654.0	16731.0	16654.0	22096	22332.0	22424.0					
12097	12525.0	12627.5	16097	16731.5	16654.5	16731.5	16654.5	22097	22332.5	22424.5					
12098	12525.5	12628.0	16098	16732.0	16655.0	16732.0	16655.0	22098	22333.0	22425.0					
12099	12526.0	12628.5	16099	16732.5	16655.5	16732.5	16655.5	22099	22333.5	22425.5					
12100	12526.5	12629.0	16100	16733.0	16656.0	16733.0	16656.0	22100	22334.0	22426.0					
12101	12527.0	12629.5	16101	16733.5	16656.5	16733.5	16656.5	22101	22334.5	22426.5					
12102	12527.5	12630.0	16102	16734.0	16657.0	16734.0	16657.0	22102	22335.0	22427.0					
12103	12528.0	12630.5	16103	16734.5	16657.5	16734.5	16657.5	22103	22335.5	22427.5					
12104	12528.5	12631.0	16104	16735.0	16658.0	16735.0	16658.0	22104	22336.0	22428.0					
12105	12529.0	12631.5	16105	16735.5	16658.5	16735.5	16658.5	22105	22336.5	22428.5					
12106	12529.5	12632.0	16106	16736.0	16659.0	16736.0	16659.0	22106	22337.0	22429.0					
12107	12530.0	12632.5	16107	16736.5	16659.5	16736.5	16659.5	22107	22337.5	22429.5					
12108	12530.5	12633.0	16108	16737.0	16660.0	16737.0	16660.0	22108	22338.0	22430.0					
12109	12531.0	12633.5	16109	16737.5	16660.5	16737.5	16660.5	22109	22338.5	22430.5					
12110	12531.5	12634.0	16110	16738.0	16661.0	16738.0	16661.0	22110	22339.0	22431.0					
12111	12532.0	12634.5	16111	16738.5	16661.5	16738.5	16661.5	22111	22339.5	22431.5					
12112	12532.5	12635.0	16112	16739.0	16662.0	16739.0	16662.0	22112	22340.0	22432.0					
12113	12533.0	12635.5	16113	16739.5	16662.5	16739.5	16662.5	22113	22340.5	22432.5					
12114	12533.5	12636.0	16114	16740.0	16663.0	16740.0	16663.0	22114	22341.0	22433.0					
12115	12534.0	12636.5	16115	16740.5	16663.5	16740.5	16663.5	22115	22341.5	22433.5					
12116	12534.5	12637.0	16116	16741.0	16664.0	16741.0	16664.0	22116	22342.0	22434.0					
12117	12535.0	12637.5	16117	16741.5	16664.5	16741.5	16664.5	22117	22342.5	22434.5					
12118	12535.5	12638.0	16118	16742.0	16665.0	16742.0	16665.0	22118	22343.0	22435.0					
12119	12536.0	12638.5	16119	16742.5	16665.5	16742.5	16665.5	22119	22343.5	22435.5					
12120	12536.5	12639.0	16120	16743.0	16666.0	16743.0	16666.0	22120	22344.0	22436.0					
12121	12537.0	12639.5	16121	16743.5	16666.5	16743.5	16666.5	22121	22344.5	22436.5					
12122	12537.5	12640.0	16122	16744.0	16667.0	16744.0	16667.0	22122	22345.0	22437.0					
12123	12538.0	12640.5	16123	16744.5	16667.5	16744.5	16667.5	22123	22345.5	22437.5					
12124	12538.5	12641.0	16124	16745.0	16668.0	16745.0	16668.0	22124	22346.0	22438.0					
12125	12539.0	12641.5	16125	16745.5	16668.5	16745.5	16668.5	22125	22346.5	22438.5					
12126	12539.5	12642.0	16126	16746.0	16669.0	16746.0	16669.0	22126	22347.0	22439.0					
12127	12540.0	12642.5	16127	16746.5	16669.5	16746.5	16669.5	22127	22347.5	22439.5					
12128	12540.5	12643.0	16128	16747.0	16670.0	16747.0	16670.0	22128	22348.0	22440.0					
12129	12541.0	12643.5	16129	16747.5	16670.5	16747.5	16670.5	22129	22348.5	22440.5					
12130	12541.5	12644.0	16130	16748.0	16671.0	16748.0	16671.0	22130	22349.0	22441.0					

ITU Telex frequency table (4/4)

FURUNO ITU TELEX FREQUENCY TABLE (4/4)

4 MHz BAND		6 MHz BAND		8 MHz BAND		12 MHz BAND		16 MHz BAND		18/19 MHz BAND		22 MHz BAND		25/26 MHz BAND				
No.	Tx	Rx	No.	Tx	Rx	No.	Tx	Rx	No.	Tx	Rx	No.	Tx	Rx	No.	Tx	Rx	
16196			16196			16196			16196			16196			16196			16196
16197			16197			16197			16197			16197			16197			16197
16198			16198			16198			16198			16198			16198			16198
16199			16199			16199			16199			16199			16199			16199
16200			16200			16200			16200			16200			16200			16200
16201			16201			16201			16201			16201			16201			16201
16202			16202			16202			16202			16202			16202			16202
16203			16203			16203			16203			16203			16203			16203
16204			16204			16204			16204			16204			16204			16204
16205			16205			16205			16205			16205			16205			16205
16206			16206			16206			16206			16206			16206			16206
16207			16207			16207			16207			16207			16207			16207
16208			16208			16208			16208			16208			16208			16208
16209			16209			16209			16209			16209			16209			16209
16210			16210			16210			16210			16210			16210			16210
16211			16211			16211			16211			16211			16211			16211
16212			16212			16212			16212			16212			16212			16212
16213			16213			16213			16213			16213			16213			16213
16214			16214			16214			16214			16214			16214			16214
16215			16215			16215			16215			16215			16215			16215
16216			16216			16216			16216			16216			16216			16216
16217			16217			16217			16217			16217			16217			16217
16218			16218			16218			16218			16218			16218			16218
16219			16219			16219			16219			16219			16219			16219
19220			19220			19220			19220			19220			19220			19220
16221			16221			16221			16221			16221			16221			16221
16222			16222			16222			16222			16222			16222			16222
16223			16223			16223			16223			16223			16223			16223
16224			16224			16224			16224			16224			16224			16224
16225			16225			16225			16225			16225			16225			16225
16226			16226			16226			16226			16226			16226			16226
16227			16227			16227			16227			16227			16227			16227
16228			16228			16228			16228			16228			16228			16228
16229			16229			16229			16229			16229			16229			16229
16230			16230			16230			16230			16230			16230			16230
16231			16231			16231			16231			16231			16231			16231
16232			16232			16232			16232			16232			16232			16232
16233			16233			16233			16233			16233			16233			16233
16234			16234			16234			16234			16234			16234			16234
16235			16235			16235			16235			16235			16235			16235
16236			16236			16236			16236			16236			16236			16236

Telex Abbreviations

Abbreviation	Meaning
ADV	Advise
ACK	Acknowledge
AGN	Again
BI (GS)	Good bye
BK	I cut off.
CFM	Confirm
COL	Collation
CRV	How do you receive?
DER	Out of order
DWN	Down
EEE	Error
FM	From
GA	Go ahead.
MNS	Minutes
MOM	Wait (Waiting)
MUTI	Mutilated
NA	Correspondence to this subscriber is not admitted.
NC	No circuits
NCH	Subscriber's number has been changed.
NP	The called party is not or no longer is a subscriber.
NR	Indicate your call number.
OCC	Subscriber is engaged.
OK	Agreed.
P (or 0)	Stop your transmission.
PLS (PSE)	Please
PPR	Paper
R (RCD)	Received
RAP	I will call you again.
RD	Read
RE	Referring to
RPT	Repeat
SRY	Sorry
SVP	Please
TAX	What is the charge?
TEST MSG	Please send a test message?
THRU	You are in communication with telex position
TKS (TNX)	Thanks
TLX	Telex

Digital Interface (IEC 61162-1)

I/O Sentences

Input sentences (IEC 61162-1)

GNS, RMC, GLL, GGA, ZDA

Input sentence description

GGA – Global positioning system(GPS) fix data

\$--GGA,hhmmss.ss,llll.lll,a,yyyyy.yyy,a,x,xx,x.x,x.x,M,x.x,M,x.x,xxxx*hh<CR><LF>

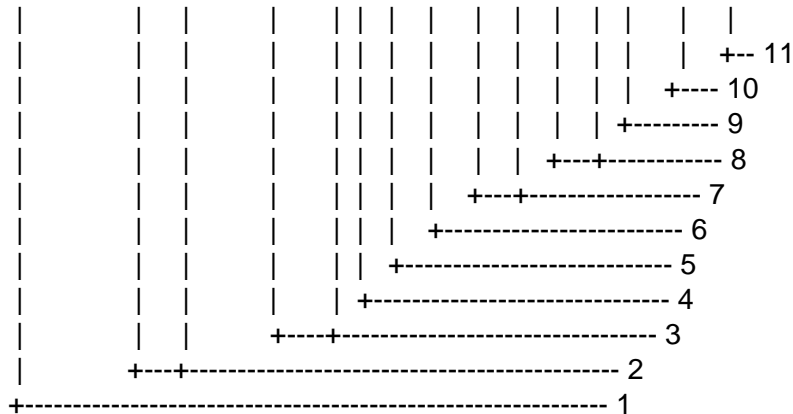

1. UTC of position
2. Latitude, N/S
3. Longitude, E/W
4. GPS quality indicator
5. Number of satellite in use,00-12, may be different from the number in view
6. Horizontal dilution of precision
7. Antenna altitude above/below mean sealevel, m
8. Geoidal separation, m
9. Age of differential GPS data
10. Differential reference station ID, 0000-1023
11. Checksum

GLL – Geographic position – latitude/longitude

\$--GLL,III.III,a,yyyyy.yyy,a,hhmmss.ss,A,a*hh<CR><LF>

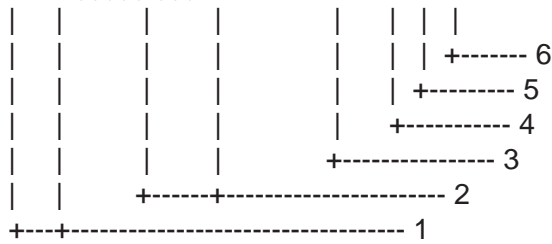

1. Latitude, N/S
2. Longitude, E/W
3. UTC of position
4. Status: A=data valid, V=data invalid
5. Mode indicator(see note)
6. Checksum

NOTE Positioning system Mode indicator:

- A = Autonomous
- D = Differential
- E = Estimated (dead reckoning)
- M = Manual input
- S = Simulator
- N = Data not valid

The Mode indicator field supplements the Status field. The Status field shall be set to V=invalid for all values of Operating Mode except for A=Autonomous and D=Differential. The positioning system Mode indicator and Status field shall not be null fields.

ZDA – Time and date

\$--ZDA,hhmmss.ss,xx,xx,xxxx,xx,xx*hh<CR><LF>

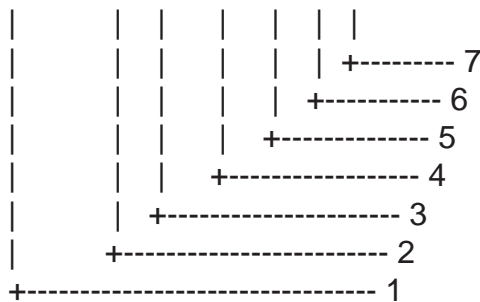

1. UTC
2. Day, 01 to 31(UTC)
3. Month, 01 to 12(UTC)
4. Year(UTC)
5. Local zone hours, 00h to +-13h
6. Local zone minutes, 00 to +59 as local hours
7. Checksum

GNS – GNSS fix data

\$-GNS,hhmmss.ss,llll.lll,a,yyyyy.yyy,a,c--c,xx,x.x,x.x,x.x,x.x,x.x*xh<CR><LF>

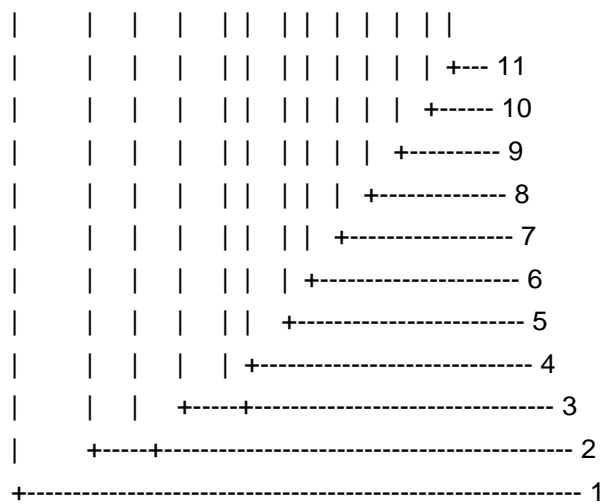

1. UTC of position
2. Latitude, N/S
3. Longitude, E/W
4. Mode indicator
5. Total number of satllite in use,00-99
6. HDOP
7. Antenna altitude, metres, re:mean-sea-level(geoid)
8. Geoidal separation
9. Age of differential data
10. Differential reference station ID
11. Checksum

RMC – Recommended minimum specific GPS/TRANSIT data

\$--RMC,hhmmss.ss,A,III.III,a,yyyyy.yyy,a,x.x,x.x,xxxxxx,x.x,a,a*hh<CR><LF>

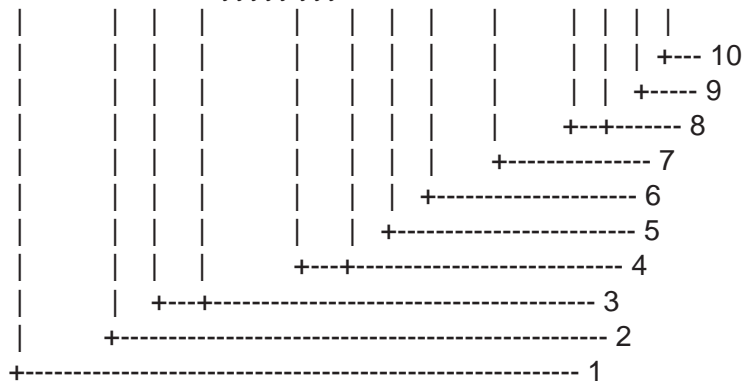

1. UTC of position fix
2. Status: A=data valid, V=navigation receiver warning
3. Latitude, N/S
4. Longitude, E/W
5. Speed over ground, knots
6. Course over ground, degrees true
7. Date: dd/mm/yy
8. Magnetic variation, degrees E/W
9. Mode indicator(see note)
10. Checksum

NOTE Positioning system Mode indicator:

- A = Autonomous
- D = Differential
- E = Estimated (dead reckoning)
- M = Manual input
- S = Simulator
- N = Data not valid

The Mode indicator field supplements the Status field. The Status field shall be set to V=invalid for all values of Operating Mode except for A=Autonomous and D=Differential. The positioning system Mode indicator and Status field shall not be null fields.

Schematic diagram

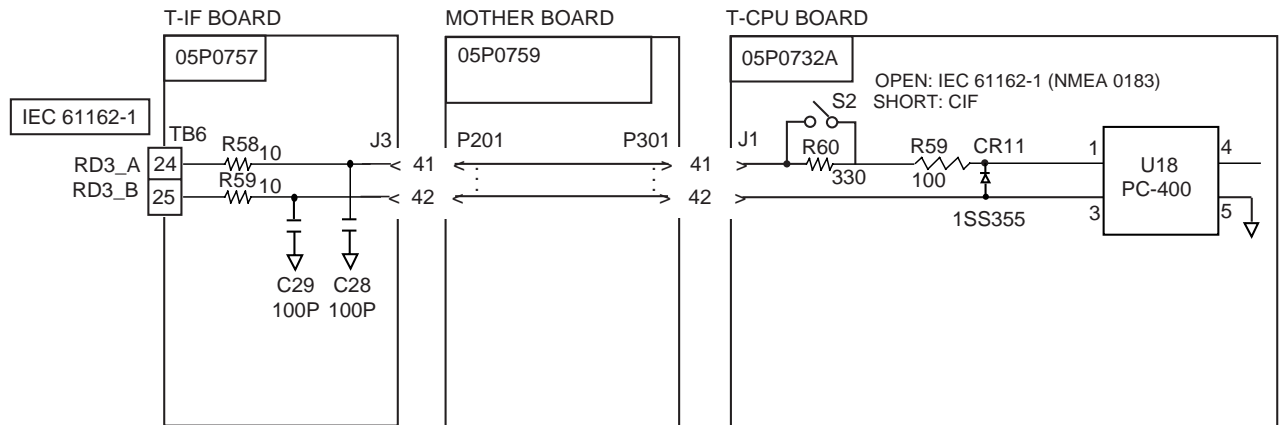

Load requirements as a listener

Isolation: Optocoupler

Input impedance: 450Ω

Max. voltage: ±15 V

Threshold: 4 mA

Parts List

This equipment contains complex modules in which fault diagnosis and repair down to component level are not practical (IMO A.694(17)/8.3.1). Only some discrete components are used. FURUNO Electric Co., Ltd. Believes identifying these components is of no value for shipboard maintenance; therefore, they are not listed in this manual. Major modules can be located on the parts location photos on pages AP-26 thru AP-30.

Transceiver unit FS-1570T

FURUNO

Model	FS-1570T	
Unit	TRANSCEIVER UNIT	
Blk.No.		

ELECTRICAL PARTS LIST

Aug-02

SYMBOL	TYPE	CODE No.	REMARKS	SHIPPABLE ASSEMBLY
PRINTED CIRCUIT BOARD				
B2	05P0731, T-I/F	005-963-050		X
B3	05P0732B, T-CPU	001-033-810		X
B4	05P0733, TX/RX	005-963-090		X
B5	05P0734A, W/R	001-005-370		X
B6	05P0735, PA	005-963-130		X
B7	05P0736, TX-FIL	005-963-150		X
B8	05P0737A, SW-REG	001-005-390		X
B9	05P0742, MB	005-963-210		X
B10	05P0746, PRESEL	005-963-250		X
B11	05P0747, REF OSC	005-963-270		X
B13	05P0751B, DSP (DSC)	001-010-380		X
B14	05P0751A, DSP (NBDP)	005-963-310		X
B17	05P0744, RELAY	005-963-230		X

Transceiver unit FS-2570T**FURUNO****ELECTRICAL PARTS LIST**

Aug-02

Model	FS-2570T	
Unit	TRANSCEIVER UNIT	
Blk.No.		

SYMBOL	TYPE	CODE No.	REMARKS	SHIPPABLE ASSEMBLY
PRINTED CIRCUIT BOARD				
B2	05P0731, T-I/F	005-963-050		X
B3	05P0732B, T-CPU	001-033-810		X
B4	05P0733, TX/RX	005-963-090		X
B5, B18	05P0734A, W/R	001-005-370		X
B6, B17	05P0739A, PA	005-956-570		X
B7	05P0736A, TX-FIL	005-963-170		X
B8	05P0737A, SW-REG	001-005-390		X
B9	05P0743, MB	005-516-340		X
B10	05P0746, PRESEL	005-963-250		X
B11	05P0747, REF OSC	005-963-270		X
B12	05P0744, RELAY	005-963-230		X
B13	05P0751B, DSP (DSC)	001-010-380		X
B14	05P0751A, DSP (NBDP)	005-963-310		X
B15	05P0738, DRV	005-516-280		X
B16	05P0740, COMB	005-516-320		X

Control unit FS-2571C

FURUNO

ELECTRICAL PARTS LIST

Model	FS-2571C	
Unit	CONTROL UNIT	
Blk.No.		

SYMBOL	TYPE	CODE No.	REMARKS	SHIPPABLE ASSEMBLY
PRINTED CIRCUIT BOARD				
B2	05P0810, PANEL	001-031-390		X
B3	05P0811A, C-CPU	001-033-850		X
B4	05P0812A, C-IF	001-033-900		X

Control unit FS-5070T**FURUNO**

Model	FS-5070T	
Unit	TRANSCEIVER UNIT	
Blk.No.		

ELECTRICAL PARTS LIST

SYMBOL	TYPE	CODE No.	REMARKS	SHIPPABLE ASSEMBLY
PRINTED CIRCUIT BOARD				
B2	05P0757, T-I/F	001-031-480		X
B3	05P0732B, T-CPU	001-033-810		X
B5	05P0733, TX/RX	005-963-090		X
B6, B26	05P0734A, W/R	001-005-370		X
B17 to 20	05P0739A, PA	005-956-570		X
B13	05P0741, TX-FIL	001-031-570		X
B12	05P0737A, SW-REG	001-035-390		X
B8	05P0759, MB	005-966-060		X
B10, 11	05P0744, RELAY	005-963-310		X
B25	05P0751A, DSP (DSC)	001-010-380		X
B9	05P0751B, DSP (NBDP)	005-963-310		X
B14	05P0738A, DRV	005-966-210		X
B21, 22	05P0740, COMB	005-516-320		X
B4	05P0760, TX	005-031-510		X
B7	05P0762, RX-FIL	005-031-540		X
B15	05P0764, PWR	005-966-020		X
B16	05P0765, DIV	005-966-030		X
B24	05P0758, TB	005-966-050		X

Parts Location

FS-1570T

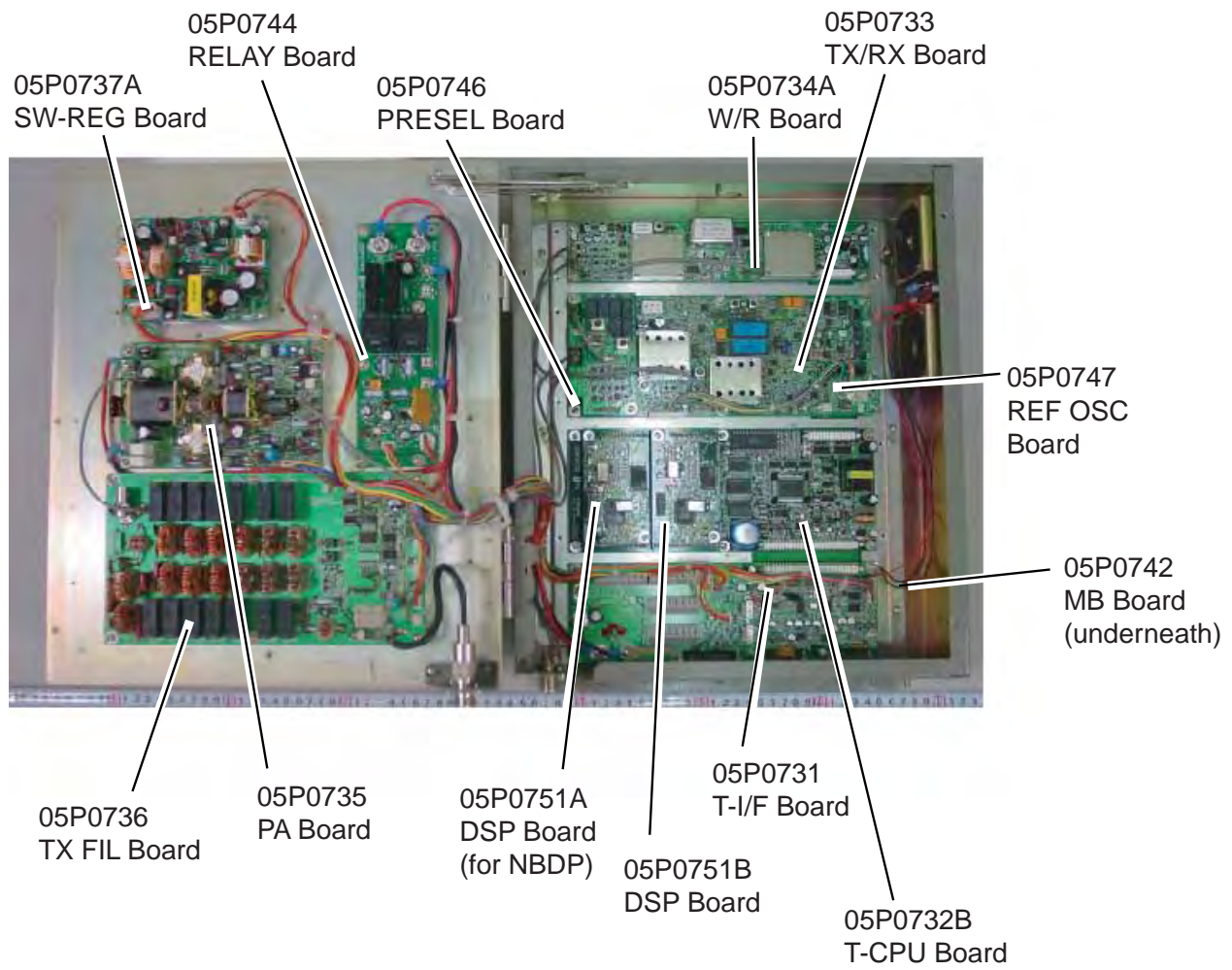

Transceiver unit FS-2570T

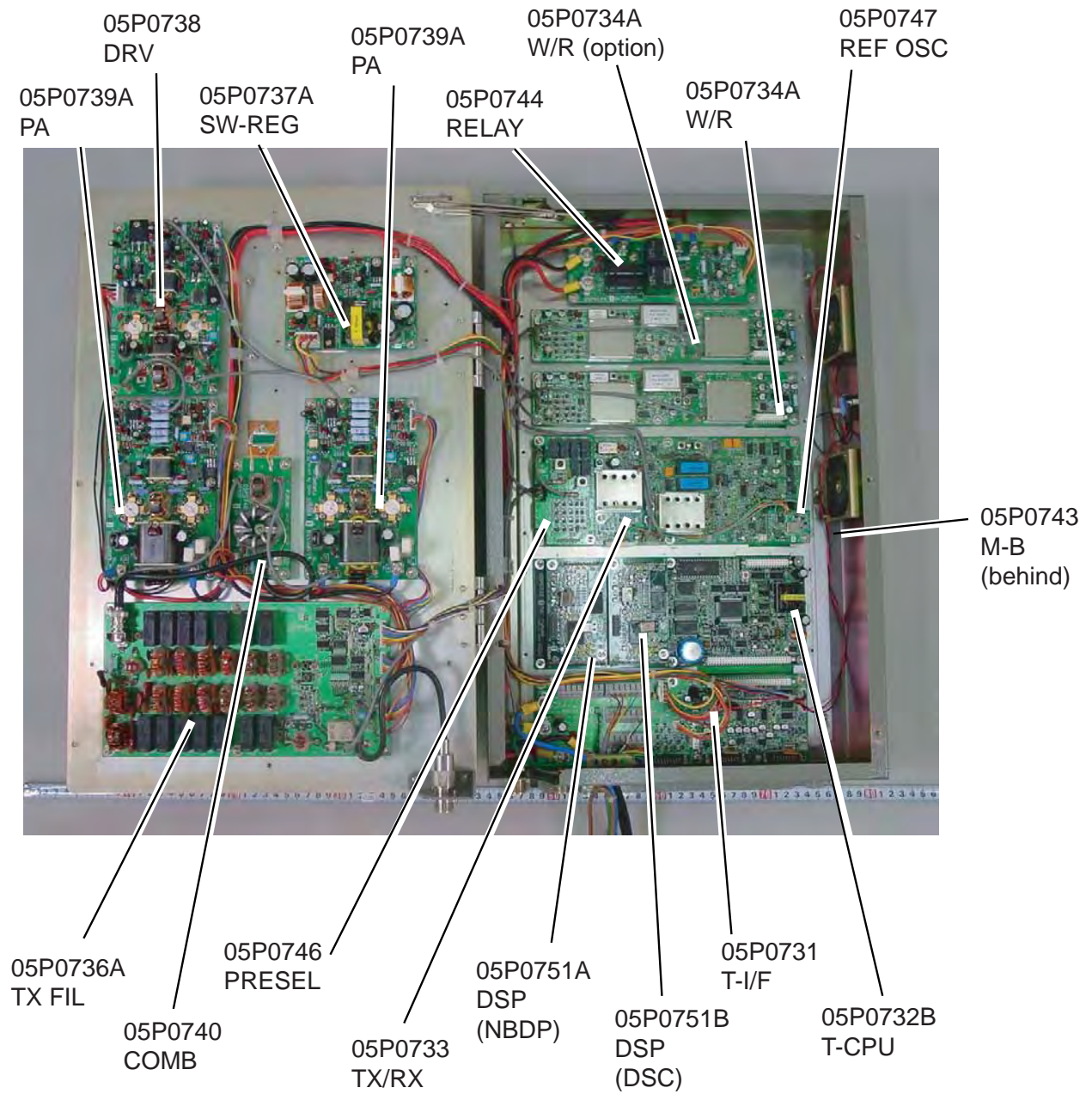

Transceiver unit FS-5070T (1)

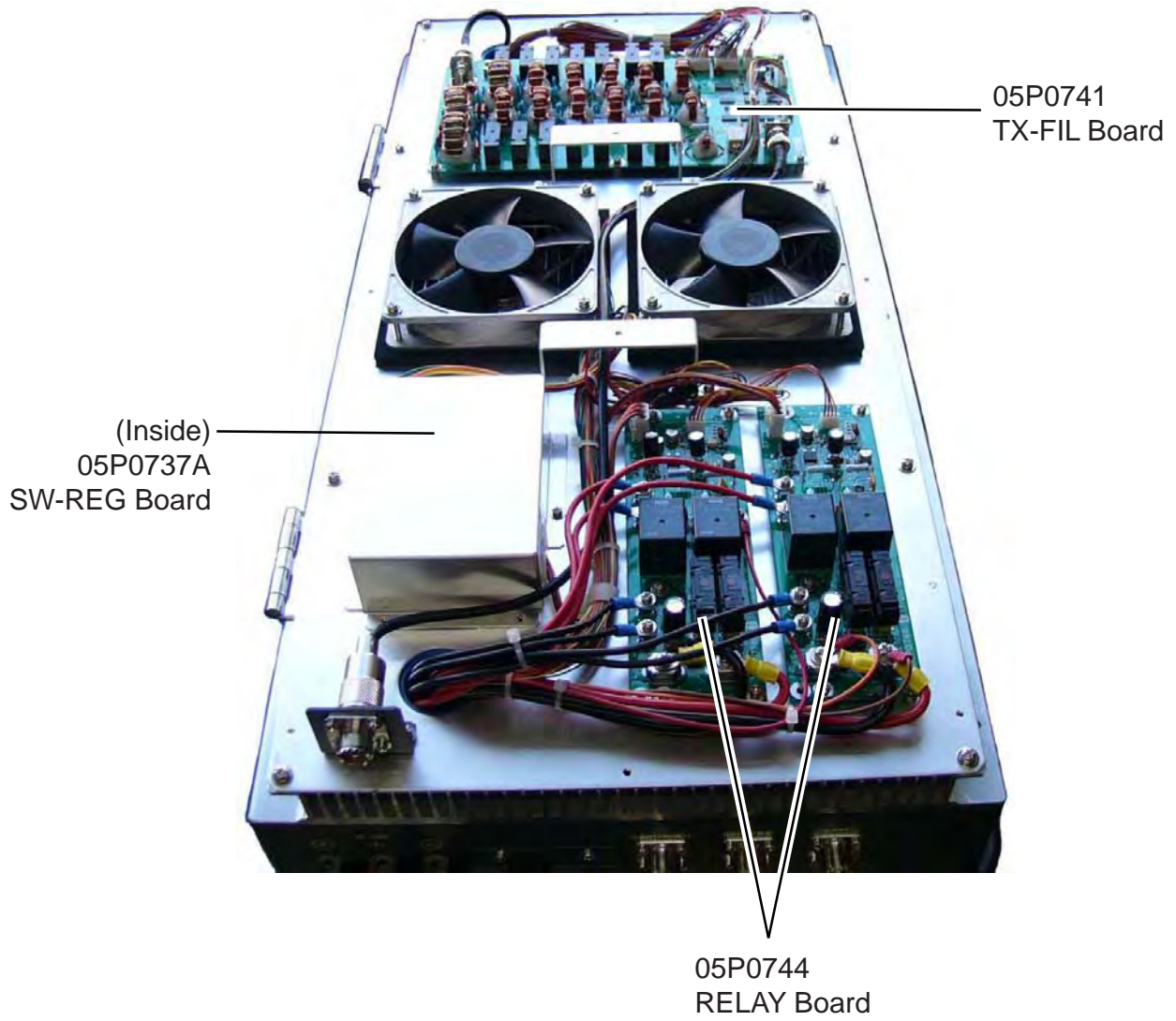

Transceiver unit FS-5070T (2)

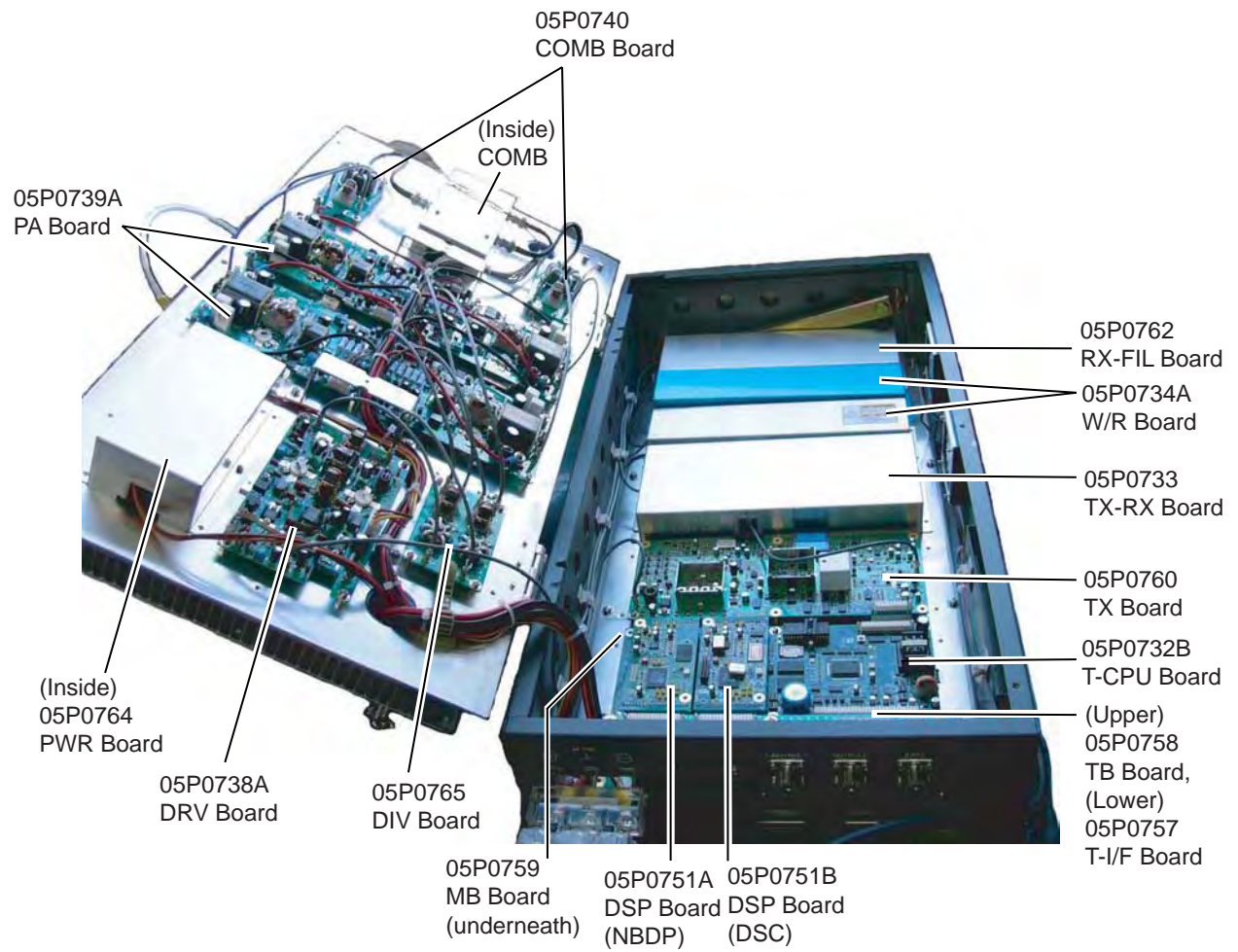

Control unit FS-2571C



05P0810
PANEL Board



05P0811A
C-CPU Board



05P0812A
C-IF Board

**SPECIFICATIONS OF SSB RADIOTELEPHONE
FS-1570/2570/5070**

1 MF/HF DIGITAL RADIOTELEPHONE

1.1 GENERAL

- 1.1.1 Communication system Full-duplex (FS-5070 only), semi-duplex or simplex
- 1.1.2 Class of emission J3E: Telephone
J2B (F1B): DSC and NBDP
H3E: reception only
- 1.1.3 Frequency range 100.00 kHz to 29,999.99 kHz
- 1.1.4 Number of channel User programmable: 256 TX/RX pairs
All ITU channels incorporated (include DSC/NBDP channel)
2182 kHz (single action)
- 1.1.5 Display method Monochrome LCD (180 x 96 dots)
- 1.1.6 Backlight 8 tones
- 1.1.7 Contrast 64 steps
- 1.1.8 Warming up 1 minute approx. (oven 20 minutes approx.)

1.2 TRANSMITTER

- 1.2.1 Frequency range 1,606.5 kHz to 26.175 MHz (100 Hz step)
- 1.2.2 RF output power FS-1570: 1.6 kHz-4 MHz: 75/100 Wpep (J3E, J2B)
4.0-26.175 MHz, 150 Wpep (J3E, J2B)
FS-2570: 1.6-4.00 MHz, 75/100/200 Wpep (J3E, J2B)
4.0-26.175 MHz, 150 Wpep (J3E, J2B)
FS-5070: 1.6-4.0 MHz, 400 Wpep (J3E, J2B)
4kHz-26.175 MHz: 500 Wpep (J3E), 400 Wpep (J2B)
- 1.2.3 Frequency error Within ± 10 Hz
- 1.2.4 Modulation AF response 350 Hz to 2.7 kHz (SSB)
- 1.2.5 Modulation system Low power balanced modulation
- 1.2.6 AF Input -46 dBm/600 ohm (Handset/Microphone)
- 1.2.7 Line in 0 dBm/600 ohm

1.3 RECEIVER

- 1.3.1 Receiving system Double-conversion superheterodyne
- 1.3.2 Frequency range 100 kHz-29,999.99 kHz (10 Hz step)
- 1.3.3 Sensitivity Input level at 10 ohm+250 pF (below 4 MHz) and 50 ohm
(above 4MHz) to produce SINAD 20 dB

Frequency Range	J3E/H3E
100 kHz to 300 kHz	35 dB μ V
300 kHz to 1.6 MHz	25 dB μ V
1.6 MHz to 4.0 MHz	13 dB μ V
4.0 MHz to 30 MHz	7 dB μ V

1.4	Intermediate frequency	1st: 72,455 kHz, 2nd: 455 kHz
1.5	Selectivity	J3E: 2.4kHz at -6dB, H3E: 6kHz at -6dB, J2B (F1B): 300Hz at -6dB
1.6	Inter-modulation	Better than 80 dB μ V
1.7	Spurious response	Better than 70 dB
1.8	AGC	SLOW/FAST/OFF
1.9	BFO frequency	Telex/DSC: 1,700 Hz, Facsimile: 1,900 Hz
1.10	Audio output power	
	FS-1570/2570	Internal speaker: 3W/8 ohm, External speaker: 4W/4 ohm
	FS-5070	Internal speaker: 1W/8 ohm, External speaker: 3W/4 ohm
	FS-1570/2570/5070	Handset: 2.5mW/150 ohm, Line output: 0 dBm/600 ohm
1.11	Standard features	Noise Blanker, Voice-activated squelch, Pre-selector

2 DSC/WATCH KEEPING RECEIVER

2.1 DIGITAL SELECTIVE CALLING

2.1.1	Frequency shift	Space: 1785.0 \pm 0.5 Hz, Mark: 1615.0 \pm 0.5 Hz
2.1.2	Baud rate	100 bps \pm 30 x 10 ⁻⁶
2.1.3	Protocol	FS-1570/2570: ITU-R Rec.M493-10, M541-8, M1082-1 FS-5070: ITU-R Rec.493-11, 541-9
2.1.4	Modulation	AFSK
2.1.5	Distress alarm	3.5 s to 4.5 s self-repetition
2.1.6	Distress alarm memory	50 messages

2.2 DSC/WATCH RECEIVER (FS-1570/2570)

2.2.1	Frequency range	
	DISTRESS	2187.5/ 8414.5 and 4207.5/ 6312/12577/16804.5 kHz
	ROUTINE	2187.5 kHz
2.2.2	Class of emission	F1B, J2B
2.2.3	Antenna impedance	50 ohm
2.2.4	Local oscillator	1st: F+54,455 kHz, 2nd: 54,000 kHz, 3rd: 456.7 kHz
2.2.5	Frequency stability	\pm 10 Hz
2.2.6	Intermediate frequency	1st: 54,455 kHz, 2nd: 455 kHz
2.2.7	Selectivity	-6 dB: 270 Hz to 300 Hz, -30 dB: within \pm 380 Hz, -60 dB: within \pm 550 Hz
2.2.8	Receiving system	Double-conversion superheterodyne
2.2.9	Radiation	within 4 nW
2.2.10	RX error rate	1 % or less at 1 μ V input voltage
2.2.11	Spurious response	31.6mV non-modulated at 10 μ V input voltage, at error rate within 1%
2.2.12	Scanning reception	max. 6 frequencies within 2 s (MF/HF)
2.2.13	Diagnosis	Transmit high frequency signal of DSC

2.3 DSC/WATCH RECEIVER (FS-5070)

2.3.1	Frequency range	
	DISTRESS	2187.5/ 8414.5 and 4207.5/ 6312/12577/16804.5 kHz
	ROUTINE	1,606.5 kHz to 27.5 MHz
2.3.2	Class of emission	F1B, J2B
2.3.3	Antenna impedance	50 ohm
2.3.4	Local oscillator	1st: F+54,455 kHz, 2nd: 54,000 kHz, 3rd: 456.7 kHz
2.3.5	Frequency stability	±10 Hz
2.3.6	Intermediate frequency	1st: 54,455 kHz, 2nd: 455 kHz
2.3.7	Selectivity	-6 dB: 270 Hz to 300 Hz, -30 dB: within ± 380 Hz, -60 dB: within ± 550 Hz
2.3.8	Receiving system	Double-conversion superheterodyne
2.3.9	Radiation	within 2 nW
2.3.10	RX error rate	1 % or less at 1 μV input voltage
2.3.11	Spurious response	31.6mV non-modulated at 10μV input voltage, at error rate within 1%
2.3.12	Scanning reception	max. 6 frequencies within 2 s (MF/HF)
2.3.13	Diagnosis	Transmit high frequency signal of DSC

2.4 GENERAL WATCH KEEPING RECEIVER (FS-2570, option)

2.4.1	Frequency range	1,606.5 kHz to 27.5 MHz
2.4.2	Class of emission	J2B, F1B
2.4.3	Antenna impedance	50 ohms
2.4.4	Local oscillator	1st: F+54,455 kHz, 2nd: 54,000 kHz, 3rd: 456.7 kHz
2.4.5	Frequency stability	within ±10 Hz
2.4.6	Intermediate frequency	1st: 54,455 kHz, 2nd: 455 kHz
2.4.7	Selectivity	-6 dB: 270 Hz to 300 Hz, -30 dB: within ± 380 Hz, -60 dB: within ±550 Hz
2.4.8	Receiving system	Double-conversion superheterodyne
2.4.9	Radiation	within 2 nW
2.4.10	RX error rate	1 % or less at 1 μV input voltage
2.4.11	Spurious response	31.6 mV non-modulated at 10μV input voltage, at error rate within 1%
2.4.12	Scanning reception	max. 6 frequencies within 2 s (MF/HF)
2.4.13	Diagnosis	Transmit high frequency signal of DSC

3 NBDP FUNCTION (OPTION)

3.1 GENERAL

3.1.1	Communication mode	ARQ, FEC, DIRC (FSK)
3.1.2	Protocol	ITU-R M625-3, M476-5, M490, M491-1, M492-6
	ID code	4, 5, 9 column

Line cord	4B/3Y (Intl.)
Modulation	AFSK
Tone frequency	1615/1785Hz \pm 0.5 Hz (mark/space)
Tracking range	\pm 80 Hz
3.1.3 Applications	
Auto-reception	Setting timer and frequency (max. 10 settings available)
Frequency scanning	10 group max., 20 station as each group
User-channels	100 channels max.

3.2 TERMINAL UNIT IB-581 (FS-1570/2570)

3.2.1 Display	9.5" monochrome LCD, 680 x 480 dots
3.2.2 CPU	ALI M6117 (33 MHz)
3.2.3 Memory	Flash ROM 2 MB, DRAM 2 MB
3.2.4 FD Drive	1.44MB 3.5"
3.2.5 Keyboard	82 keys, IBM PS/2

3.3 TERMINAL UNIT IB-583

3.3.1 Display	10.4" color TFT LCD, 640 x 480 dots
3.3.2 CPU	HD6417615 (15.5 MHz)
3.3.3 Memory	Flash ROM: 1 MB, S-RAM: 256 KB
3.3.4 FD drive	1.44MB 3.5"
3.3.5 Keyboard	82 keys, IBM PS/2
3.3.6 Other functions	Text editor, FD control, Printer, Remote control for transceiver, Diagnosis

4 ANTENNA COUPLER (FS-1570/2570)

4.1 Tuning system	CPU controlled fully automatic tuning system
4.2 Frequency range	1.6 MHz to 27.5Hz
4.3 Input impedance	50 ohms
4.4 Antenna	10 m to 18 m wire or whip antenna
4.5 Power capability	150 W (FS-1570), 250 W (FS-2570)
4.6 VSWR	1.5 max
4.7 Tuning Speed	Within 15 s
4.8 Dummy Load	FS-1570: 10 ohms+250 pF/100W FS-2570: 10 ohms+250 pF/200W

5 ANTENNA COUPLER (FS-5070)

5.1 Tuning system	CPU controlled fully automatic tuning system
5.2 Frequency range	1.6MHz to 29.9 MHz
5.3 Input impedance	50 ohm (viewed from transceiver)
5.4 Antenna	10 m to 18 m wire or whip antenna + wire
5.5 Pre-tuning power	10 W

- 5.6 VSWR less than 1.5
- 5.7 Tuning time 0.2 to 2 seconds typical (within 2 to 15 seconds)
- 5.8 Antenna BK relay Internal, optional supply

6 INTERFACE

- 6.1 Input data sentences IEC 61162-1 (NMEA 0183-3)
 - Ship's Position (L/L) GGA>RMC>GLL
 - Time ZDA

7 POWER SUPPLY

- 7.1 Transceiver/control unit
 - FS-1570: 24 VDC, 0.8 A, max. 20A (TX)
 - FS-2570: 24 VDC, 1.5 A, max. 35A (TX)
 - FS-5070: 24 VDC, 3 A (RX), max. 35 A (TX)
- 7.2 Terminal unit
 - IB-581: 24VDC, 0.8 A
 - IB-583: 24 VDC: 0.6 A
- 7.3 Printer (PP-510) 24 VDC: 1.5 A
- 7.4 AC/DC power supply unit 100/110/115/220/230 VAC, 1 phase, 50/60Hz

8 ENVIRONMENTAL CONDITION

- 8.1 Ambient temperature
 - Indoor units -15°C to +55°C
 - Antenna coupler -25°C to +55°C
- 8.2 Relative humidity 93% or less at 40°C
- 8.3 Degree of protection
 - Control unit IPX2 (panel), IPX0 (chassis)
 - Transceiver/terminal unit IPX0
 - Antenna coupler IPX5 (FS-1570/2570), IPX6 (FS-5070)
- 8.4 Bearing vibration
 - 2 Hz-5Hz to 13.2 Hz: Amplitude: $\pm 1 \text{ mm} \pm 10\%$
 - 13.2 Hz to 100 Hz: Max. acceleration 7 m/s^2 , fixed

9 COATING COLOR

- 9.1 Control/terminal unit N3.0 (panel), 2.5GY5/1.5 (chassis)
- 9.2 Transceiver unit 2.5GY5/1.5
- 9.3 Antenna coupler N9.5 (white)

This page is intentionally left blank .

INDEX

1/ RT/2182 key	1-2
2/DSC key	1-1
4/Intcom key	1-6
7/🔊 key	1-4
8/PRINT key	6-19
9/📶 key	1-2
Channel selection	2-2
Contrast	1-4
Control description.....	1-1
Dimmer	1-4
Distress alert	
receiving on either VHF channel 70 or MF	
channel 2187.5	4-7
receiving on HF band	4-10
sending	4-2
Distress relay	
on behalf of other ship, to area ships	4-18
on behalf of other ship, to coast station	4-14
receiving	4-21
to coast station on HF band	4-10
DSC frequency table	AP-3
Error messages	11-4
Frequency selection	2-3
Geographical area call	
receiving	5-18
sending	5-16
Group call	
receiving	5-14
sending	5-12
IA	2-4
IC	2-4
Individual call	
manual acknowledge.....	5-9
Intercom.....	1-6
Key Assignment.....	6-22
Log file	
description	5-36
opening	5-36
LOG/TUNE key.....	5-36
Medical transport call	
receiving	5-23
sending	5-21
Menu tree	AP-1

NBDP Terminal Unit	
answerback code registration	8-1
communications buffer.....	10-10
edit menu [F2]	7-7
file deleting	9-8
file editing	9-3
file menu [F1]	7-6
file opening.....	9-7
file renaming.....	9-7
file saving	9-2
file saving under new name	9-8
ID code registration	8-2
macrofiles	10-10
manual calling	10-1
menu overview	7-4
operate menu [F3].....	7-8
printing.....	9-8
scan channel group editing, deleting	8-8
scan channel group registration.....	8-7
station editing, deleting	8-4
station menu [F5]	7-10
station registration.....	8-3
system menu [F6].....	7-11
timer program editing, deleting	8-6
timer program registration.....	8-5
user channel registration.....	8-6
window menu [F4].....	7-9
NBDP Terminal Unit	
ARQ mode	10-3
FEC mode	10-5
general test	11-9
receive mode.....	10-5
scanning	10-9
terminal unit.....	7-1
timer operation	10-8
tone test	11-9
Neutral craft call	
receiving	5-20
sending.....	5-19
Polling call	
receiving.....	5-24
Position call	
other ship requests your position.....	5-28
POWER knob.....	1-2

INDEX

Print out menu	6-19	printing	6-12
PSTN call		PSTN call	6-9
charge information.....	5-35	Test call	11-6
receiving	5-33	Transmitter power	2-4
sending	5-30	Troubleshooting	11-3
RF	2-4	Tuning	2-3
Scan frequency setup.....	6-21	USER CH menu.....	2-8
Send message call		User channels	
test call.....	6-10	deleting.....	6-4
Send message files		registering	6-2
group call	6-8	VC	2-4
individual call	6-4		

Declaration of Conformity



0560

We **FURUNO ELECTRIC CO., LTD.**

(Manufacturer)

9-52 Ashihara-Cho, Nishinomiya City, 662-8580, Hyogo, Japan

(Address)

declare under our sole responsibility that the product

MF/HF SSB Radiotelephone Types: FS-1570 and FS-2570

(Model name, type number)

to which this declaration relates conforms to the following standard(s) or normative document(s)

Standards

Test standards

IMO Resolutions MSC.36(63), A.694(17)
IMO Resolutions MSC.68(68)/A3, A.806(19)
IMO MSC Circular MSC/Circ.862

EN 300 338 V1.2.1: 1999-4, ETS 300 373: 1995-08,
ETS 300 373/A1: 1997-8, ETS 300 067:1990-11,
ETS 300 067/ A1:1993-11, EN 301 033 V1.1.1: 1998-08,
EN 60945: 2002-10 Ed.4, IEC 61162-1: 2000-07 Ed.2

ITU-R Recommendations M.1173, M.1082-1, M.821-1, M.493-10, M.493-11, M.541-8, M.541-9, M.476-5,
M491-1, M.492-6, M.625-3

(title and/or number and date of issue of the standard(s) or other normative document(s))

For assessment, see

- EC type-examination (Module B) certificate N°: 02212010 issued by Telefication, The Netherlands
- Product Quality System (Module D) certificate No. P 112 issued by Telefication, The Netherlands

This declaration is issued according to the provisions of European Council Directive 96/98/EC on marine equipment and the amending Directive 2008/67/EC.

On behalf of Furuno Electric Co., Ltd.

Takahiko Kusuda
Manager, QMS Secretariat
Quality Assurance Department

Nishinomiya City, Japan
September 11, 2009

(Place and date of issue)

(name and signature or equivalent marking of authorized person)

Declaration of Conformity



0560

We **FURUNO ELECTRIC CO., LTD.**

(Manufacturer)

9-52 Ashihara-Cho, Nishinomiya City, 662-8580, Hyogo, Japan

(Address)

declare under our sole responsibility that the product

HF/MF SSB Radiotelephone with integrated DSC and NBDP Type: FS-5070

(Model name, type number)

to which this declaration relates conforms to the following standard(s) or normative document(s)

Standards

Test standards

IMO Resolutions MSC.36(63), A.694(17)

IMO Resolutions MSC.68(68)/A3, A.806(19)

IMO MSC Circular MSC/Circ.862

ITU-R Recommendations

M.1173, M.1082-1, M.493-11, M.541-9, M.476-5, M491-1, M.492-6, M.625-3

EN 300 338 V1.2.1: 1999-04, EN 300 373-1 V1.2.1: 2002-10

ETS 300 065/A1: 1998-9, ETS 300 067/A1: 1993-10

EN 301 033 V1.1.1: 1998-08

EN 60945: 2002-10 Ed.4, IEC 61162-1: 2000-07 Ed.2

(title and/or number and date of issue of the standard(s) or other normative document(s))

For assessment, see

- EC type-examination (Module B) certificate N°: 06212004 issued by Telefication, The Netherlands
- Product Quality System (Module D) certificate No. P 112 issued by Telefication, The Netherlands

This declaration is issued according to the provisions of European Council Directive 96/98/EC on marine equipment and the amending Directive 2008/67/EC.

On behalf of Furuno Electric Co., Ltd.

Nishinomiya City, Japan
September 11, 2009

(Place and date of issue)

Takahiko Kusuda
Manager, QMS Secretariat
Quality Assurance Department

(name and signature or equivalent marking of authorized person)