

FURUNO

OPERATOR'S MANUAL

INMARSAT-C MES

Model **FELCOM 18**

FURUNO ELECTRIC CO., LTD.

9-52 Ashihara-cho,
Nishinomiya, 662-8580, JAPAN

• FURUNO Authorized Distributor/Dealer

All rights reserved. Printed in Japan

Pub. No. OME-56740-N1

(TEHI) FELCOM18

A : JUN. 2012
N1 : NOV. 29, 2024



0 0 0 1 9 8 3 5 5 1 2

IMPORTANT NOTICES

General

- This manual has been authored with simplified grammar, to meet the needs of international users.
- The operator of this equipment must read and follow the instructions in this manual. Wrong operation or maintenance can void the warranty or cause injury.
- Do not copy any part of this manual without written permission from FURUNO.
- If this manual is lost or worn, contact your dealer about replacement.
- The contents of this manual and the equipment specifications can change without notice.
- The example screens (or illustrations) shown in this manual can be different from the screens you see on your display. The screens you see depend on your system configuration and equipment settings.
- Save this manual for future reference.
- Any modification of the equipment (including software) by persons not authorized by FURUNO will void the warranty.
- The following concern acts as our importer in Europe, as defined in DECISION No 768/2008/EC.
 - Name: FURUNO EUROPE B.V.
 - Address: Siriusstraat 86, 5015 BT, Tilburg, The Netherlands
- The following concern acts as our importer in UK, as defined in SI 2016/1025 as amended SI 2019/470.
 - Name: FURUNO (UK) LTD.
 - Address: West Building Penner Road Havant Hampshire PO9 1QY, U.K.
- All brand, product names, trademarks, registered trademarks, and service marks belong to their respective holders.
- Windows is a trademark of the Microsoft group of companies.
- SD is a trademark of SD-3C, LLC.

How to discard this product

Discard this product according to local regulations for the disposal of industrial waste. For disposal in the USA, see the homepage of the Electronics Industries Alliance (<http://www.eiae.org/>) for the correct method of disposal.

How to discard a used battery

Some FURUNO products have a battery(ies). To see if your product has a battery, see the chapter on Maintenance. If a battery is used, tape the + and - terminals of the battery before disposal to prevent fire, heat generation caused by short circuit.

In the European Union

The crossed-out trash can symbol indicates that all types of batteries must not be discarded in standard trash, or at a trash site. Take the used batteries to a battery collection site according to your national legislation and the Batteries Directive 2006/66/EU.

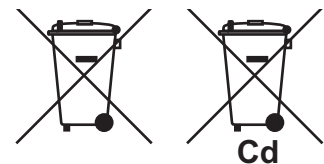

In the USA

The Mobius loop symbol (three chasing arrows) indicates that Ni-Cd and lead-acid rechargeable batteries must be recycled. Take the used batteries to a battery collection site according to local laws.

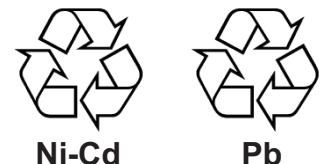



In the other countries

There are no international standards for the battery recycle symbol. The number of symbols can increase when the other countries make their own recycle symbols in the future.















SAFETY INSTRUCTIONS



The operator must read the safety instructions before attempting to operate the equipment.

 WARNING	Indicates a potentially hazardous situation which, if not avoided, could result in death or serious injury.
 CAUTION	Indicates a potentially hazardous situation which, if not avoided, could result in minor or moderate injury.

 Warning, Caution	 Prohibitive Action	 Mandatory Action
--	--	--



 WARNING							
	Do not open the equipment. The equipment uses high voltage that can cause electrical shock. Refer any repair work to a qualified technician.						
	Do not approach the antenna unit closer than the distance shown below when transmitting. <table border="1" data-bbox="263 1153 614 1243"> <tr> <th>Radiation Level</th> <th>At</th> </tr> <tr> <td>10W/m²</td> <td>0.5 m</td> </tr> <tr> <td>100W/m²</td> <td>0.1 m</td> </tr> </table> The radome emits radio waves that can be harmful, particularly the eyes.	Radiation Level	At	10W/m ²	0.5 m	100W/m ²	0.1 m
Radiation Level	At						
10W/m ²	0.5 m						
100W/m ²	0.1 m						
	If water leaks into the equipment or something is dropped into the equipment, immediately turn off the power at the switchboard. Fire or electrical shock can result.						
	If the equipment is giving off smoke or fire, immediately turn off the power at the switchboard. Fire or electrical shock can result.						
	If you feel the equipment is acting abnormally or giving off strange noises, immediately turn off the power at the switchboard and contact a FURUNO service technician.						

 WARNING	
	Do not disassemble or modify the equipment. Fire, electrical shock or serious injury can result.
	Make sure no rain or water splash leaks into the equipment protected from the weather. Fire or electrical shock can result if water leaks into the equipment.
	Do not place liquid-filled containers on or near the equipment. Fire or electrical shock can result if a liquid spills into the equipment.
	Do not operate the equipment with wet hands. Electrical shock can result.
	Use the proper fuse. Use of the wrong fuse can cause fire or electrical shock.

 CAUTION	
	Handle the terminal unit carefully. The terminal unit uses an LCD, which can cause injury if broken.

Warning Label

A warning label is attached to the terminal unit. Do not remove the label. If the label is missing or damaged, contact a FURUNO agent or dealer about replacement.

 WARNING 	 警告 
To avoid electrical shock, do not remove cover. No user-serviceable parts inside.	感電の恐れあり。 サービスマン以外の方はカバーを開け ないで下さい。内部には高電圧部分が 数多くあり、万一さわると危険です。

Name: Warning Label (2)

Type: 03-129-1001-3

Code No.: 100-236-743-10

TABLE OF CONTENTS

FOREWORD	viii
SYSTEM CONFIGURATION	x
1. INMARSAT C SYSTEM	
OVERVIEW	1-1
1.1 Introduction	1-1
1.2 Communications Network	1-3
2. OPERATIONAL OVERVIEW	2-1
2.1 Terminal Unit.....	2-1
2.1.1 Audio alarm	2-2
2.1.2 How to adjust the display brightness.....	2-2
2.1.3 How switch between Day and Night mode.....	2-2
2.2 Keyboard.....	2-2
2.2.1 Key description.....	2-3
2.2.2 Shortcut keys	2-4
2.2.3 Function keys	2-4
2.3 Distress Alert/Received Call Unit IC-305, Alarm Unit IC-306.....	2-5
2.4 Printer.....	2-6
2.5 Standby Display	2-7
2.5.1 Display indications	2-8
2.6 Menu Overview	2-12
2.7 Error Messages and Alerts.....	2-13
2.8 How to Use a PC as a Sub Terminal	2-13
2.8.1 How to install the software	2-13
2.8.2 How to start, quit the application	2-15
2.8.3 How to select the printer to use.....	2-16
2.8.4 How to back up the system to PC or storage media	2-16
3. SYSTEM INITIALIZATION	3-1
3.1 System Settings	3-1
3.1.1 Confirm the main terminal	3-1
3.1.2 System setup	3-1
3.2 Terminal Setup.....	3-3
3.3 Login and Logout	3-8
3.3.1 Login	3-8
3.3.2 Logout	3-9
3.4 EGC Settings	3-10
3.4.1 What is the EGC (Enhanced Group Call) service?	3-10
3.4.2 EGC settings.....	3-11
3.4.3 How to add EGC channels.....	3-13
3.4.4 How to automatically save and print EGC messages	3-14
3.5 How to Add NCS Channels.....	3-15
3.6 LES List.....	3-16
3.6.1 How to register an LES to the LES list.....	3-16
3.6.2 How to edit the LES list.....	3-17
3.6.3 How to restore the default LES list.....	3-17
3.6.4 How to print the LES list.....	3-17
3.7 Station List	3-17
3.7.1 How to add stations to the station list.....	3-17
3.7.2 How to edit the station list	3-20

3.7.3	How to print the station list	3-20
3.8	How to Enter Position	3-20
3.9	How to Create a Directory	3-21
3.9.1	How to create a directory for message storage.....	3-21
3.9.2	How to specify the directory for message storage	3-22
3.9.3	How to delete a directory.....	3-22
3.10	E-mail Service/SMS Station List.....	3-23
3.11	E-mail Settings	3-24
3.12	How to Export, Import System Settings.....	3-25
3.12.1	How to export system settings	3-25
3.12.2	How to import system settings	3-25
4.	FILE OPERATIONS	4-1
4.1	Files and Working Areas	4-1
4.2	Preparing Files	4-1
4.2.1	How to prepare a routine file	4-1
4.2.2	How to prepare a confidential file	4-2
4.2.3	Editor menu settings.....	4-3
4.2.4	Text operations.....	4-4
4.3	How to Save Files.....	4-6
4.3.1	How to handle SD cards (including SDHC cards)	4-6
4.3.2	How to save files	4-7
4.4	How to Open Files	4-7
4.4.1	How to open a file.....	4-7
4.4.2	How to switch between files	4-8
4.4.3	How to open a file when both working areas are occupied	4-8
4.5	How to Save a File Under a New Name.....	4-8
4.6	How to Print Files	4-8
4.7	How to Combine Files	4-9
4.8	How to Delete Files	4-9
4.9	How to Change File Name	4-9
4.10	How to Decode an E-Mail Attachment.....	4-10
5.	INMARSAT COMMUNICATIONS.....	5-1
5.1	How to Send a Message	5-1
5.1.1	Code description	5-1
5.1.2	How to send a prepared message	5-2
5.1.3	How to send a saved file	5-9
5.1.4	How to cancel transmission on a message awaiting transmission.....	5-10
5.1.5	How to request delivery status	5-10
5.1.6	How to access the 2-digit code service	5-13
5.1.7	Sent message log.....	5-14
5.1.8	How to delete a sent message	5-14
5.2	Receiving.....	5-15
5.2.1	When a message is received	5-15
5.2.2	How to set the receive alarm.....	5-16
5.2.3	How to display and print received messages	5-16
5.2.4	How to automatically print received messages	5-18
5.2.5	How to save received messages.....	5-18
5.2.6	How to automatically save received messages.....	5-18
5.2.7	How to delete received messages	5-19
5.3	Communication Log.....	5-19
5.3.1	How to display and print the communication log	5-19
5.3.2	How to automatically print the communication log	5-20
5.4	EGC Messages	5-20
5.4.1	How to display and reprint EGC messages.....	5-20

TABLE OF CONTENTS

5.4.2	How to display EGC closed network ID (ENID)	5-21
5.4.3	How to receive EGC distress or urgent message	5-21
5.4.4	How to display the EGC message log.....	5-22
5.4.5	How to delete EGC messages	5-22
6.	DATA REPORT AND POLLING	6-1
6.1	Data Reporting	6-1
6.1.1	How to prepare a data report	6-2
6.1.2	How to prepare a message report.....	6-3
6.1.3	How to automatically print data report, polling command	6-4
6.2	Polling	6-5
6.2.1	Polling commands.....	6-5
6.2.2	Other polling commands	6-6
6.2.3	Polling reception.....	6-7
6.3	DNID (Data Network Identification).....	6-8
6.3.1	How to display DNIDs	6-8
6.3.2	How to enable, disable DNIDs	6-8
6.4	EPADR (Enhanced Pre-Assigned Data Reporting)	6-10
6.4.1	How to prepare a data report	6-10
6.5	LRIT Compliance	6-11
6.5.1	LRIT overview	6-11
6.5.2	About the LRIT system.....	6-12
7.	DISTRESS OPERATIONS	7-1
7.1	How to Send the Distress Alert	7-1
7.2	How to Send the Distress Alert with Nature of Distress Specified	7-2
7.3	How to Prepare the Distress Message.....	7-4
7.4	How to Test the DISTRESS Button.....	7-5
8.	OTHER FUNCTIONS	8-1
8.1	How to Abort an Operation.....	8-1
8.2	How to Scan NCS Common Channels	8-1
8.3	How to Select EGC Receiving Channel	8-2
8.4	How to Select NCS Channel	8-2
8.5	How to Find LES Information	8-3
9.	E-MAIL BY PC	9-1
9.1	Introduction	9-1
9.1.1	Overview of mail functions	9-1
9.1.2	E-mail restrictions.....	9-1
9.1.3	E-mail characteristics	9-2
9.2	How to Connect the FELCOM to a Single PC.....	9-3
9.3	Function Settings	9-4
9.3.1	How to set IP address and subnet mask.....	9-4
9.3.2	DHCP setting	9-5
9.3.3	Gateway setting	9-6
9.3.4	How to restrict access	9-7
9.3.5	How to restrict the size of outgoing messages.....	9-8
9.3.6	How to automatically convert attachments.....	9-8
9.3.7	How to connect the FELCOM to the shipboard LAN mail server	9-9
9.3.8	Selective forwarding.....	9-10
9.4	Example of How to Set E-mail Client	9-11
9.4.1	How to change the POP3 password	9-12
9.5	SMTP Error Messages.....	9-12

10. MAINTENANCE AND TROUBLESHOOTING	10-1
10.1 General Checking and Maintenance	10-1
10.2 Diagnostics	10-2
10.2.1 Self test at power on.....	10-2
10.2.2 Diagnostic.....	10-2
10.3 Performance Verification (PV) Test.....	10-3
10.3.1 PV test sequence	10-3
10.3.2 PV test procedure.....	10-3
10.3.3 How to show the PV test results.....	10-4
10.4 System Status Monitor	10-5
10.5 Current Position Log.....	10-6
10.6 How to Replace the Fuse	10-7
10.7 Alert and Warning Messages	10-7
10.7.1 Alert messages.....	10-7
10.7.2 Alert window	10-8
10.7.3 Warning messages.....	10-9
10.8 Troubleshooting.....	10-10
APPX. 1 MENU TREE	AP-1
APPX. 2 MESSAGES	AP-9
APPX. 3 ABBREVIATIONS	AP-13
APPX. 4 INTERNATIONAL TELEX/TEL. COUNTRY CODE LIST, LES LIST	AP-17
APPX. 5 INTERNATIONAL TELEX ABBREVIATIONS, INTERNATIONAL TELEGRAPHY ALPHABET	AP-25
APPX. 6 DIGITAL INTERFACE	AP-27
APPX. 7 ALERT LIST AND CODES	AP-38
SPECIFICATIONS	SP-1
INDEX	IN-1

FOREWORD

A Word to FELCOM18 Owners

Congratulations on your choice of the FURUNO FELCOM18 Inmarsat C MES. We are confident you will see why the FURUNO name has become synonymous with quality and reliability.

Since 1948, FURUNO Electric Company has enjoyed an enviable reputation for innovative and dependable marine electronics equipment. This dedication to excellence is furthered by our extensive global network of agents and dealers.

This equipment is designed and constructed to meet the rigorous demands of the marine environment. However, no machine can perform its intended function unless operated and maintained properly. Please carefully read and follow the recommended procedures for operation and maintenance.

We would appreciate hearing from you, the end user, about whether we are achieving our purposes.

Thank you for considering and purchasing FURUNO equipment.

Features

Mainly consisting of an antenna unit and a terminal unit, the FELCOM18 provides the full range of distress and general communication services for mobile and fixed terrestrial subscribers in the Inmarsat C communication network. Its compact size permits installation where space is limited.

The main features are

- Complies with Conforms to the following standards: IMO A.807(19), MSC.68(68) Annex 4, MSC/Circ 862, IMO A.694(17), IEC 60945-4, IMO A.664(16), IEC61097-4, IEC 61162-1, IEC 61162-450, IEC62923-1, IEC62923-2, MSC.431(98), MSC.306(87), MSC.302(87).
- Full coverage of Inmarsat-C services: EGC, Internet E-mail, distress messaging, polling, data reporting.
- GMDSS compliant with optional printer, AC/DC power supply unit
- Terminal unit accepts a wide variety of external equipment: Distress Alert/Received Call Unit IC-305, Alarm Unit IC-350, Alarm Unit IC-306, PC, navigator, etc.
- Shipborne LAN Ethernet
- Store-and-forward telex communication (public telex network)
- GPS receiver (option) built in the terminal unit provides GPS-generated position.
- Data reporting and polling
- EPADR (Enhanced Pre-Assigned Data Reporting) applicable.
- VMS (Vessel Monitoring Service) applicable.
- Remote distress alert unit

Program No.

Unit	Program no.	Date of modification
TERMINAL UNIT	1650247-xx	
PC TERMINAL	1650240-xx	

xx=program version no.

About Inmarsat-C

This manual provides a brief introduction to the Inmarsat C system, in Chapter 1. For further information, see the Inmarsat home page at www.inmarsat.com.

CE/UKCA declaration

With regards to CE/UKCA declarations, please refer to our website (www.furuno.com), for further information about RoHS conformity declarations.

Disclosure of Information about China RoHS

With regards to China RoHS information for our products, please refer to our website (www.furuno.com).

SYSTEM CONFIGURATION

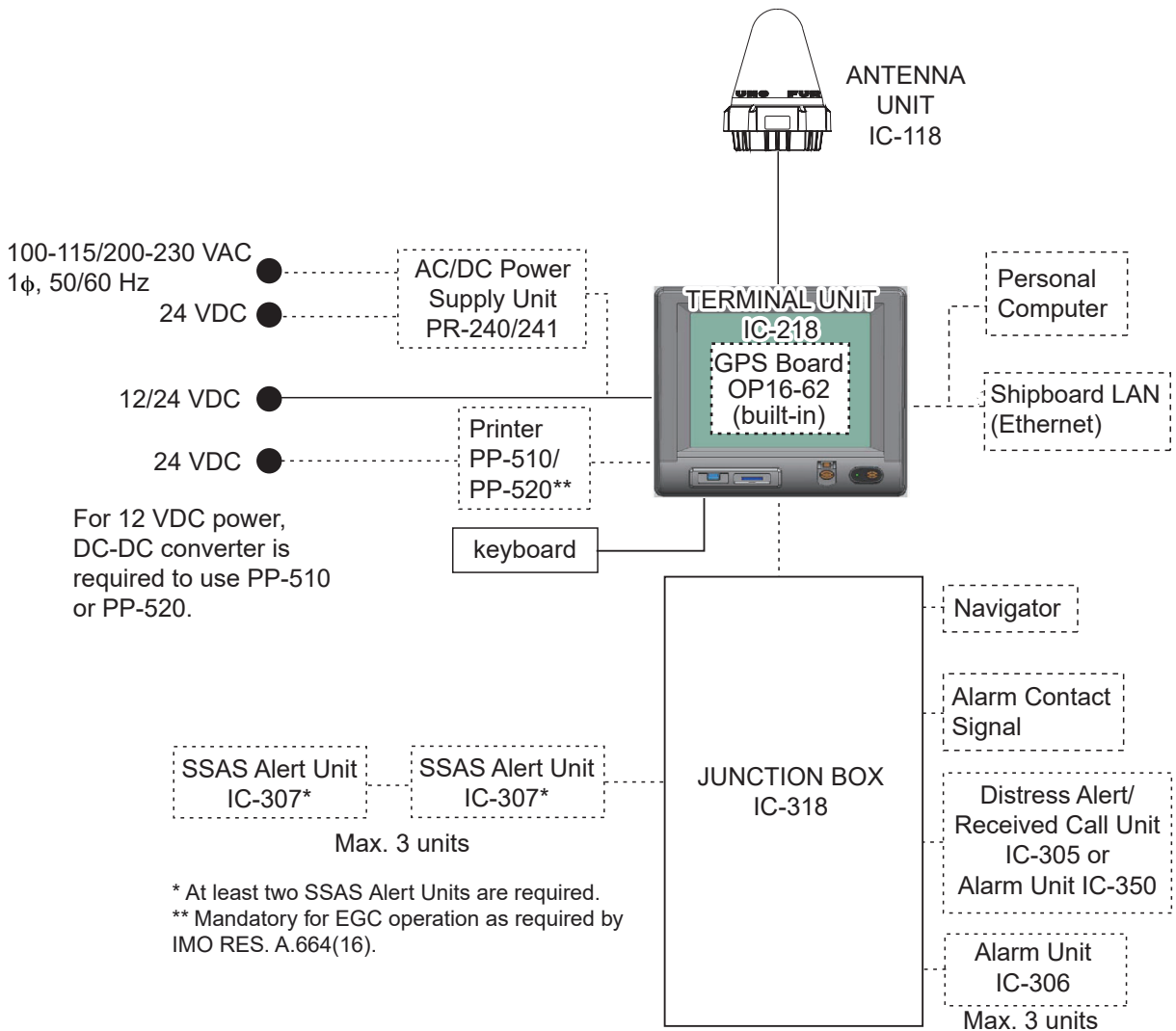

CATEGORY OF UNITS (required by IEC60945):

Unit	Category
Terminal Unit	Protected from the weather (For indoor installation)
Antenna Unit	Exposed to the weather (For installation on the open deck)
Other Units	Protected from the weather (For indoor installation)

— : Standard supply
 - - - : Optional or Local supply

Display viewing distance: 0.7 m

1. INMARSAT C SYSTEM OVERVIEW

1.1 Introduction

The Inmarsat C system provides worldwide telex and data transmission and reception of written information to owners of an Inmarsat C transceiver or a terrestrial telex network via satellite. Further, e-mail can be sent via the internet.

Communication mode is store-and-forward telex, which means all information sent are first stored at an LES (Land Earth Station) and then delivered to designated party.

An EGC (Enhanced Group Call) receiver is built in the FELCOM system to receive the following types of messages, broadcast by LESs:

- SafetyNET™: Governments and maritime authorities can use this service to distribute maritime safety information to ships within selected areas.
- FleetNET™: Commercial subscription organizations or shipping companies can use this service to transmit trade information (for example, company news or market prices) simultaneously to a selected group of ships, to provide up-to-the-minute information.
- EGC system-related messages are sent by Inmarsat to certain shipping companies and geographical areas.

The FELCOM system allows you to make distress calls. They are given immediate priority over all other calls, and are automatically routed to a land-based Rescue Co-ordination Centre (RCC).

Besides its primary application of ship-shore, shore-ship or ship-ship communications, the Inmarsat C service has also proved beneficial to trucking firms who have found it indispensable for communicating with their vehicles. This manual, however, concentrates on ship applications, the main application.

1. INMARSAT C SYSTEM OVERVIEW

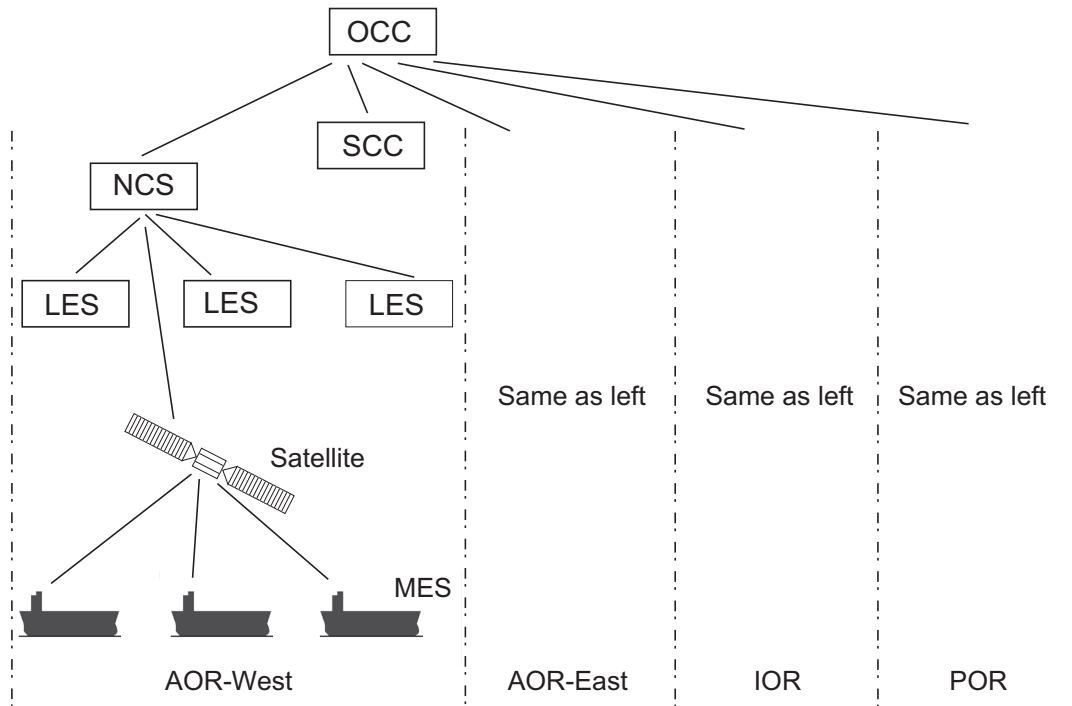

OCC: Operation Control Center
 SCC: Satellite Control Center
 NCS: Network Coordination Station
 MES: Mobile Earth Station
 LES: Land Earth Station

Inmarsat-C system configuration

The Inmarsat C system consists of the Operation Control Center (OCC), Satellite Control Centers (SCC), Network Coordination Stations (NCS), Land Earth Stations (LES) and Mobile Earth Stations (MES). The OCC, located at Inmarsat's London headquarters, coordinates a wide range of activities in the Inmarsat system, including commissioning of mobile earth stations.

The Inmarsat C system divides the world into four regions and each region is covered by its own satellite.

Inmarsat system satellites

Region	Satellite	Satellite position
AOR-West	I-4 F3 AMER	98.4°W
AOR-East	I-3 F5 AORE	54.0°W
IOR	I-4 Alphasat EMEA	25.0°E
POR	I-4 F1 APAC	143.5°E

In each region there is one NCS and several LESs. The NCS keeps track of all Inmarsat C transceivers in its region and broadcasts information such as navigational warnings, weather reports and news. The LESs provide the link between the MES and the terrestrial telecommunications networks via satellite.

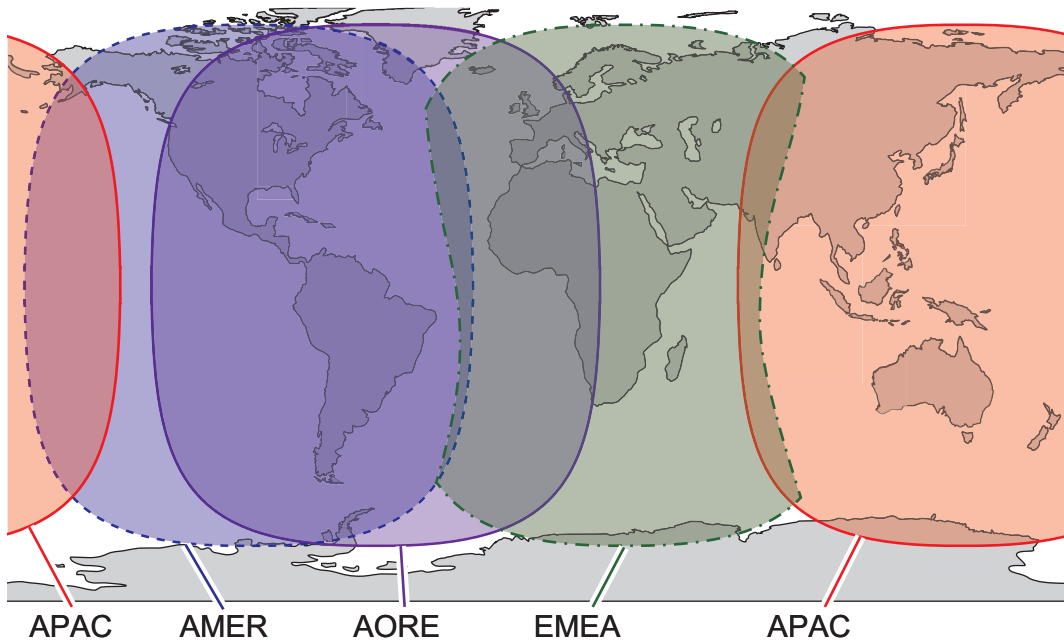

Inmarsat-C satellite coverage area

1.2 Communications Network

The illustration below shows the Inmarsat C communications network.

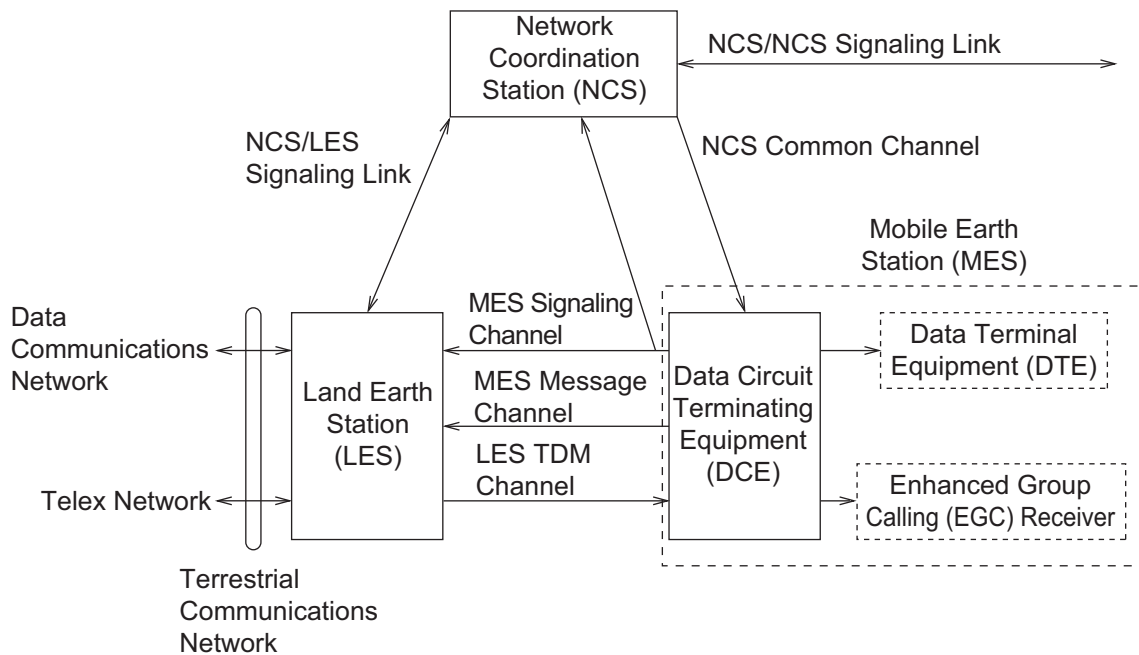

1. INMARSAT C SYSTEM OVERVIEW

Section	Description
NCS common channel	The NCS has two major functions: <ul style="list-style-type: none"> • Transmit information on a common channel. • Transmit EGC messages to MESs.
NCS/LES signaling link	The NCS/LES signaling link connects the NCS to all LESs in its region. All EGC messages pass through this link.
LES TDM channel	The LES TDM channel carries the circuit control signal for MES and transmits messages from LES to MES.
MES message channel	The MES message channel carries messages from MES to LES.
MES signaling channel	The MES signaling channel transmits requests, distress alerts, data reports, etc. This channel also carries login and logout from MES to NCS.
NCS/NCS signaling link	This NCS/NCS signaling link connects all NCSs. This link exchanges data among NCSs operating in different ocean regions.
MES interface	The MES consists of the Data Circuit Terminating Equipment (DCE) and the Data Terminal Equipment (DTE). The DCE consists of the antenna unit, and the DTE consists of a terminal unit, a keyboard and printer.
Terrestrial network interface	The major functions of the LESs are: <ul style="list-style-type: none"> • Telex store-and-forward conversion • Handling EGC messages • Handling distress alerts • Data reporting and polling

Types of MES

There are three types of MES: class 1, class 2 and class 3. This FELCOM is a class 2 MES.

Class 1:	<ul style="list-style-type: none"> • Transmits messages to LES. • Receives messages from LES.
Class 2:	<ul style="list-style-type: none"> • The functions of class 1 plus operation as an EGC receiver when not transmitting or receiving. • EGC-only receiver
Class 3:	The function of class 1 plus simultaneous operation as an EGC-only receiver.

2. OPERATIONAL OVERVIEW

2.1 Terminal Unit

The terminal unit is the heart of the FELCOM system, creating, transmitting and receiving messages. The unit consists of a display, **POWER** switch, **DISTRESS** button, USB port and SD card slot.

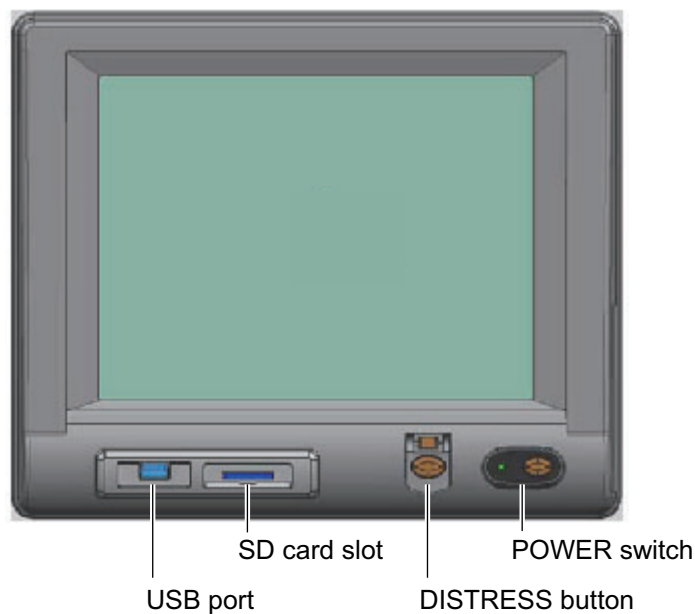

Note: The response of the LCD is slower in low temperatures.

Item	Function
POWER switch	Turns the Terminal Unit and equipment connected to the Terminal Unit on and off.
DISTRESS button	Transmits the distress alert to an LES, when there is a life-endangering situation on your ship.
SD card slot, SD card	The SD card stores transmitted and received messages, settings, etc.
USB port	Connects a mini USB keyboard.

2. OPERATIONAL OVERVIEW

2.1.1 Audio alarm

The terminal unit releases an audio alarm under the following conditions.

Unit	Telex, e-mail rec'd	Distress ACK rec'd	EGC message received			Trouble found
			Distress	Urgent	Safety/Normal	
Terminal unit IC-218	YES	YES	YES	YES	NO	YES
Distress alert/ Received call unit IC-305, Alarm Unit IC-350	NO	YES	YES	YES	NO	NO
Alarm unit IC-306	YES	NO	NO	NO	NO	YES

2.1.2 How to adjust the display brightness

Adjust the display brightness as shown below. Ten levels are available.

Increase brightness: Alt+F7

Decrease brightness: Alt+F6

2.1.3 How switch between Day and Night mode

To switch between Day mode (Preset 1) and Night mode (Preset 3), press and hold the **Alt** key then press the **F8** key.

2.2 Keyboard

The FELCOM is almost 100% keyboard (SKB-E3UN or TK-HG01UMBK) controlled. Operation is carried out with the function keys, numbered F1-F10 at the top of the keyboard. The figure below shows the keyboard and the function of each function key.

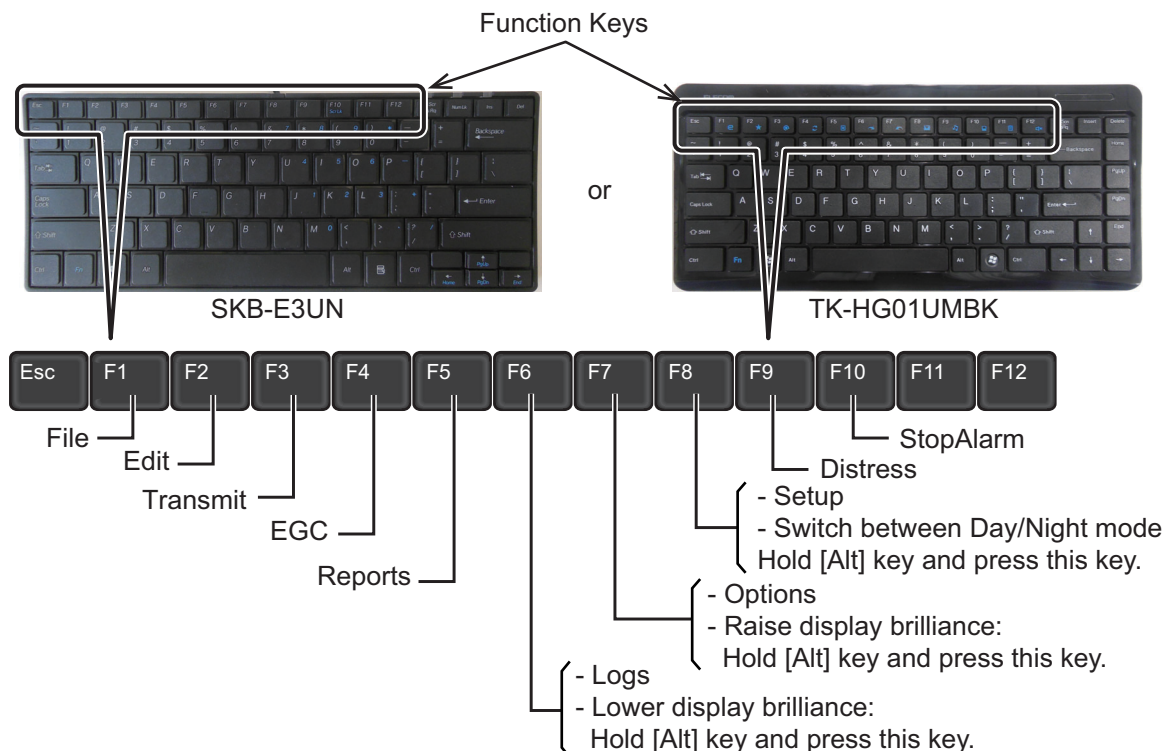

2.2.1 Key description

Key	Function
Esc	<ul style="list-style-type: none"> • Cancels key input and returns to previous display screen. • Long push to return to the standby display.
F1 - F12	Select menus. See section 2.2.3.
BackSpace	Deletes the character to the left of the cursor.
Ins (SKB-E3UN) Insert (TK-HG01UMBK)	Works the same as "paste." See "How to cut and paste text" in section 4.2.4.
Del (SKB-E3UN) Delete (TK-HG01UMBK)	Deletes the character selected with the cursor.
Home	Moves the cursor to the top of the message being edited.
End	Moves the cursor to the bottom of the message being edited.
PgUp	Goes to the previous page of the edit screen.
PgDn	Goes to the next page of the edit screen.
↑, ↓, ←, →	Control the cursor.
Enter	Registers key input; inserts carriage return in TX message.
Shift	Selects upper or lower case alphabet. Press and hold down the key and then press the [Caps Lock] key to get upper or lower case alphabet. Note that only upper case alphabet are used in telex.
Alt	Provides the shortcut key operation when combined with an alphabet key. See section 2.2.2.
Spacebar	Inserts a space. In addition, it displays the file list, a partial view of a file, etc., depending on menu.
Caps Lock	Turns upper case alphabet input on or off. The Caps Lock LED lights when upper case alphabet input is on.
Tab	Inserts horizontal tab characters. The number of tab characters the key can insert per line of text can be programmed for two, four or eight tabs.
Ctrl	Works in combination with alphabet keys as follows: <ul style="list-style-type: none"> • Ctrl + [M]: Same as Enter. • Ctrl + [H]: Same as Back Space. • Ctrl + [I]: Same as Insert. • Ctrl + [V]: Same as Overwrite+Insert on Edit Mode in the Editor Setup menu.
NumLk (SKB-E3UN only)	Turns numeric input on or off. Note that you cannot enter alphabet when the NumLk LED is lit.

Note: In telex, lower case, #, &, *, \$, @, %, etc. are not permitted. A full list of characters usable in telex appears in the Appendix. For e-mail all characters and symbols may be used.

2.2.2 Shortcut keys

The FELCOM provides the keyboard shortcuts shown below for commonly used functions.

Shortcut key	Function
Alt+F6	Lower display brilliance.
Alt+F7	Raise display brilliance.
Alt+F8	Switch between Day mode and Night mode.
Alt+N	Same as [New] in [File] menu.
Alt+O	Same as [Open] in [File] menu.
Alt+Q	Same as [Close] in [File] menu.
Alt+D	Same as [Delete] in [File] menu.
Alt+S	Save as [Save] in [File] menu.
Alt+P	Save as [Print] in [File] menu.
Alt+X	Same as [Undo] in [Edit] menu; undo last [Cut], [Paste].
Del/Delete	Same as [Cut] in [Edit] menu.
Alt+C	Same as [Copy] in [Edit] menu.
Ins/Insert	Same as [Paste] in [Edit] menu.
Alt+V	Same as [Change Window] in [Edit] menu.

2.2.3 Function keys

The function keys are labeled F1-F10 on the keyboard and they provide the functions shown in the table below. If you get lost in operation, you can return to the standby display by long pressing the **Esc** key.

Menu (key)	Function
File (F1)	Opens and closes file; print files; MIME decoding.
Edit (F2)	Text editing facilities (copy, paste, search and replace, etc.).
Transmit (F3)	Transmit messages; request delivery status.
EGC (F4)	Display EGC messages; show EGC network ID.
Reports (F5)	Facilities for data reporting, message reporting, and EPADR.
Logs (F6)	Display logs for sent and received messages, EGC messages; show the communications log.
Options (F7)	Facilities for login and logout, manual position input, testing, maintenance, NCS and ocean region selection.
Setup (F8)	Menus for system setup, editor setup, EGC setup, auto mode setup, e-mail setup, and configuration.
Distress (F9)	Prepare the distress alert message.
StopAlarm (F10)	Silence audio alarm.
(F12)	Shows the alert list display.

2.3 Distress Alert/Received Call Unit IC-305, Alarm Unit IC-306

Distress Alert/Received Call Unit IC-305

The **DISTRESS** button functions to transmit the distress alert. To transmit the distress alert, press the button (approx. 4 seconds) until its lamp lights continuously. For further details on how to transmit the distress alert, see section 7.1.

The IC-305 releases the audio alarm and the lamp in the **ALARM ACK** button flashes when an EGC distress or urgency broadcast is received. Press the **ALARM ACK** button to acknowledge the alarm, and the alarm tone changes. To silence the alarm and extinguish the lamp, press the **F10** key on the keyboard of the terminal unit.

Alarm Unit IC-306

The IC-306 releases the audio alarm and flashes the lamp in its **ALARM RESET** button when a telex or e-mail is received. To silence the audio alarm, press the **ALARM RESET** button on the IC-306. In addition to telex and e-mail notification, the audio alarm sounds and the lamp flashes also for the troubles listed below.

- “Unsync” condition (MES is not synchronized with satellite) continues for six minutes. (UNSYNC appears at the bottom of the screen.)
- BBER is over 80% (BBER of 080 or higher appears on the system status monitor).
Note: The equipment cannot scan automatically in the above two conditions. Re-select ocean region referring to section 8.2.
- Printer has no paper.
- No data is received from internal or external GPS navigator.
- Update position alert (manual position input) when position has not been updated for four hours.
- Equipment trouble (synthesizer, oscillator, etc.)

To acknowledge the audio alarm, press the **ALARM RESET** button, and the alarm tone changes. To silence the alarm and the flashing of the button in case of external equipment abnormality, press the **F10** key on the keyboard of the terminal unit.

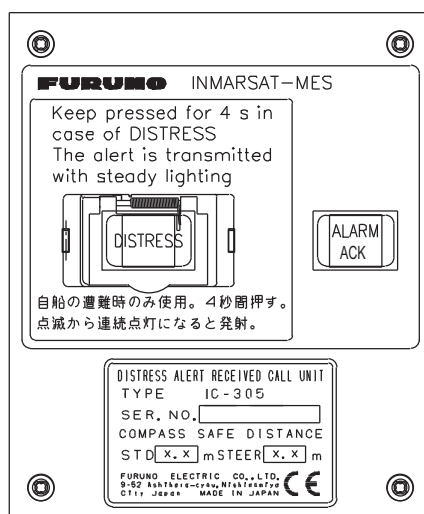

Distress Alert/Received Call Unit IC-305

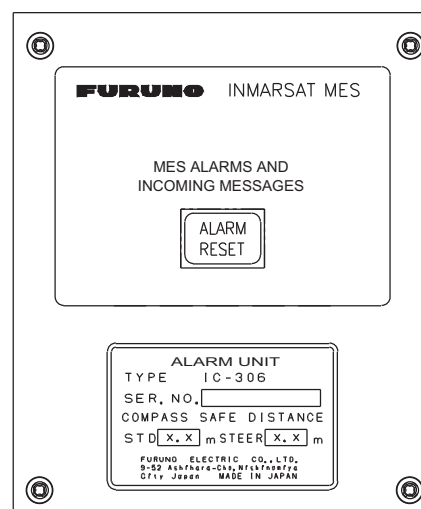

Alarm Unit IC-306

2.4 Printer

A printer can be connected to print transmitted and received messages. For the operating procedures, see the owner's manual of the PP-510, PP-520. Below are the controls of the PP-520.

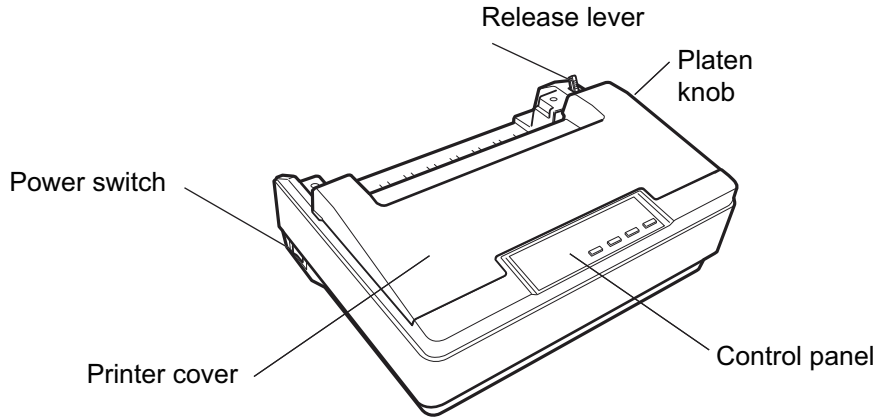

Part	Description
Power switch	Turns the power on or off.
Printer cover	Open to replace the ink ribbon cartridge; clear a paper jam. Keep the cover closed otherwise
Control panel	Controls the printer functions.
Platen knob	Ejects the paper manually. Clears a paper jam. Do not touch in the Online mode.
Release lever	Releases paper to straighten or remove it

2.5 Standby Display

After the equipment is turned on and the diagnostic test is completed, the standby display appears, showing the results of the test. The system status monitor provides various operating information. For further information, see section 10.4.

File	Edit	Transmit	EGC	Reports	Logs	Options	Setup	Distress	StopAlarm
Date	(EXT)	Jan-12-12				BBER		IMN:	443156710
Time		01:32 (UTC)				C/N			000
Position	(EXT)	LAT 34:30.00N				Send Level			OK (0)
		LON 135:00.00E				Rx AGC Level			OK (254)
Waypoint	(EXT)	LAT				REF Offset Freq			OK (0 Hz)
		LON				Synthe Local			OK
Course	(EXT)	345.5 DEG				TCXO Control			131
Speed	(EXT)	10.2 kn							
Current NCS		344 (IOR/EMEA)	LOGOUT			Antenna Power Supply			OK(7.4V)
Current Channel		NCS CC							
Current TDM		NCS CC				Water Temperature	(EXT)		68.2 DEG
MES Status		Idle				Water Current	(EXT)		
GPS Status		****				Direction			232 DEG
						Speed			1.9 kn
DCE Memory		32818 Bytes free				Depth	(EXT)		
Current State: IDLE				Retuning		Jan-12-12 01:32 (UTC)			
				NCS: IOR/EMEA LOGOUT		LAT: 34:30.00N			
DCE F18 Ver. xx				REC. MESSAGE EXIST		LON: 135:00.00E			

xx: Program Version No. of TERMCPU Board

The indication "(EXT)" appears when data is sourced from an external device. For Position, the indication changes to "(MAN)" when position data is manually entered, either at the source device or the FELCOM18. If the data input for positioning is not available, an indicator appears for both external and manual indications as follows: External/internal position data: red dot; manual position data: yellow dot.

Note: If positioning data is not updated or input for more than four hours, the indicator changes to red color regardless of the data source.

After the diagnostic test is completed, the equipment automatically starts synchronizing itself with a satellite. When the indication "Retuning" is replaced with "SYNC(NCS)", the synchronization process is completed. Then, you are ready to receive EGC messages. See section 3.4.

Note: When the caution "Pre-set LES ID for DISTRESS ALERT is invalid in the present ocean region. Please input preferred LES ID in the [Distress Alert Setup] menu." appears. Change the LES ID in the distress alert setup to match current ocean region. See section 7.2.

2. OPERATIONAL OVERVIEW

2.5.1 Display indications

The display is divided in three areas:

- 1) The function menu area
- 2) The working area
- 3) The operating status area

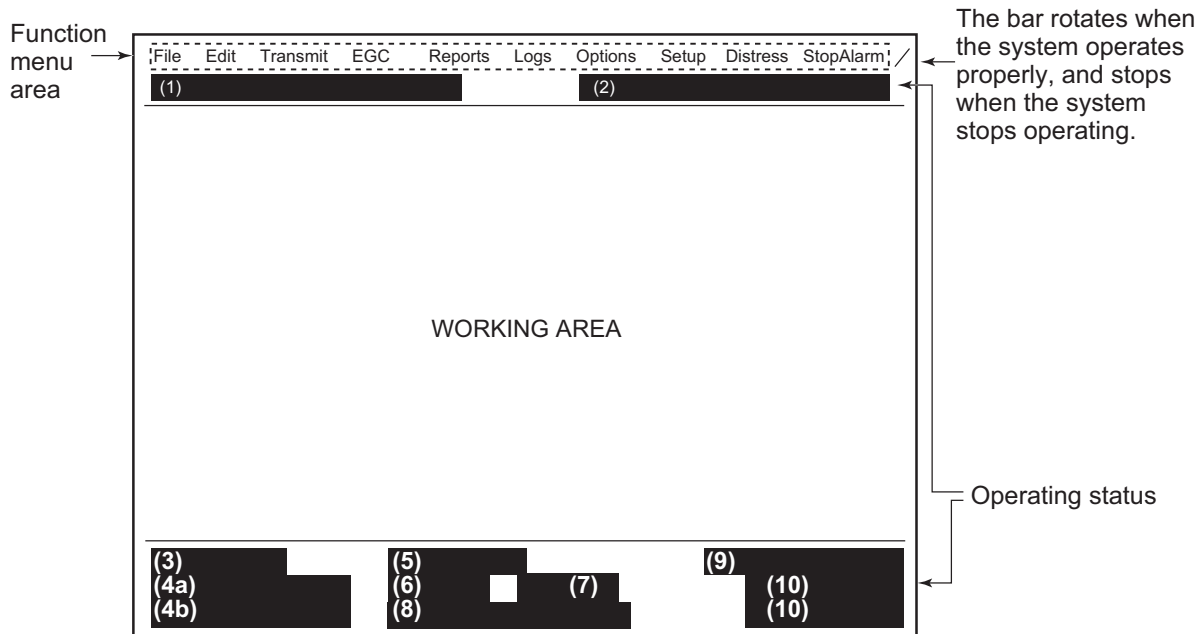

(1) Distress alert information message area

No display (no distress alert).
Sending Distress Alert.
Sending Distress Alert Test.
Distress Acknowledgment Received.
Distress Message Call Activated.
Distress Message Call Acknowledged.
Distress Button Test Mode.

(2) Communication network mode

No display: Normal operation.
Stand alone mode: Stand alone mode.
Restoration mode (reverse video): Previously designated LES is transmitting the NCS common channel signal.

(3) Terminal unit status

IDLE: Idle (awaiting receiving, awaiting transmitting).

IDLE (PENDING): Awaiting reply from LES.

SENDING: Sending.

RECEIVING: Receiving.

LOGIN: Logging in with NCS.

LOGOUT: Logging out with NCS.

DISTRESS ALERT: When own vessel is transmitting the distress alert.

Data Report: Sending data report.

TESTING: Performance Verification (PV) testing.

TEST SETUP: Requesting PV testing.

SCANNING: NCS scanning.

EGC RECEIVER (Reverse video): EGC-only receiver operation.

DELIVER STATUS REQ.: Transmitting delivery status request.

FORCED CLEARING: Stopping receiving, transmitting, or scanning.

4(a) Communication status

CALLING: Now calling.

WAITING FOR ACKNOWLEDGEMENT: Waiting for acknowledgment from LES.

RECEIVING EGC MESSAGE: Now receiving EGC message.

WAITING FOR BACKOFF: Waiting to transmit data report.

Successful Login.: Login was successful.

Login failed.: Login failed.

Successful Logout: Logout was successful.

Logout failed.: Logout failed.

Successful Distress Alert: Distress alert transmitted successfully.

Distress Alert Failed: Distress alert could not be transmitted.

Successful Forced Clearing.: Forced clearing successful.

Forced Clearing Failed.: Forced clearing unsuccessful.

SENDING MESSAGE PACKETS: Sending TX message packets.

WAITING FOR ACKNOWLEDGEMENT: Waiting for acknowledgment from LES.

Successful sending to LES.: Message successfully sent to LES.

Sending message failed.: Message could not be sent to LES.

Call rejected.: LES rejected your message.

Call pending.: LES temporarily suspending communications.

Received Call.: Call received from LES.

Received Call(ITA2).: Call(ITA2) received from LES.

RECEIVING MESSAGE PACKETS: Receiving message packets.

CLEARING: Clearing TX sequence.

Successful receiving.: You successfully received message.

Receiving failed.: You could not receive message.

Successful Data Report.: Data report successfully sent.

Data Report failure.: Data report could not be sent.

PV TEST CALL is rejected.: PV test call rejected by NCS.

PV TEST CALL is pending.: PV test call pending by LES.

TEST-RECEIVING MESSAGE: Receiving test message from LES.

TEST-SENDING MESSAGE: Sending test message to LES.

TEST-DISTRESS ALERT: Sending test distress alert to LES.

WAITING FOR ACTIVATION: Waiting start of PV test.

WAITING FOR TEST RESULT: Waiting for results of PV test.

CLEARING: Clearing PV test.

2. OPERATIONAL OVERVIEW

PV TEST is Completed.: PV test is completed.

PV TEST Failure.: PV test failed.

(4b) TERMCPU program version number

DCE F18 Ver. XX: CPU version (Terminal CPU; XX = Version Number).

Running Report Program (POLL): Polling report in progress.

TX ON: Transmission in progress.

TROUBLE: ANT power voltage: Power supply to the antenna has abnormal voltage.

TROUBLE: ALARM UNIT Fault.: Alarm Unit IC-306 is not operating normally.

TROUBLE: DISTRESS ALERT UNIT Fault.: Distress Alert Unit IC-305 is not operating normally.

TROUBLE: DISTRESS Button Abnormality: Distress button is not operating normally.

TROUBLE: Synthesizer module.: Synthesizer is not operating normally.

TROUBLE: Carrier power module.: Transmission power not at normal level.

TROUBLE: GPS module.: GPS module is not operating normally.

Memory full for received msg: Memory is full, cannot receive messages.

DISTRESS Position over 24hours ago: Own ship position for Distress Alert has not been updated for more than 24 hours.

(5) Frame synchronization

Blank: Changing channel, or during transmission.

SYNC (NCS): Synchronizing with NCS.

SYNC (LES): Synchronizing with LES.

MES Sig. Ch: Changing MES signaling channel.

MES Msg. Ch: Changing MES message channel.

UNSYNC: Out of synchronization.

Retuning: Synchronizing with NCS or LES.

(6) Ocean region currently being receiving

No display: Out of sync with satellite.

AORW/AMER: Atlantic Ocean Region-West.

AORE: Atlantic Ocean Region-East.

POR/APAC: Pacific Ocean Region.

IOR/EMEA: Indian Ocean Region.

(7) Logging status

LOGOUT: Logged out with ocean region.

LOGIN: Logged in with ocean region.

(8) Other information

Various messages appear at this location.

No display: No receive message in memory, or printer is operating.

REC. MESSAGE EXIST (reverse video): Displayed when a routine message has not been printed, or a confidential message is received.

Data Report: When data reporting is activated.

Message Report (reverse video): Message report setting is activated.

(9) Date and time display

With connection of a navigator (internal GPS navigator or external navigator), date and time (received from satellite) are displayed. Manually input date and time are also displayed.

(10) Position

With connection of a navigator (internal GPS navigator or external navigator), ship's position is displayed in latitude and longitude, or manually input position is displayed.

BAM mode and active alert

The active alert screen displays the latest three active alerts at the bottom right of the screen (sorted by priority and time of occurrence). Press the F12 key to display the alert list and check all alerts.

File Edit Transmit EGC Reports Logs Options Setup Distress StopAlarm			
			IMN: 443156710
Date	11-11-11	BBER	000
Time	04:25 (UTC)	C/N	NG (30 dB)
		Send Level	OK (0)
Position	LAT	Rx AGC Level	OK (254)
	LON	REF Offset Freq	NG (468 Hz)
Waypoint	LAT	Synthe Local	OK
	LON	TCXO Control	131
Course	DEG		
Speed	kn		
Current NCS	144 (AORE)	LOGOUT	Antenna Power Supply NG (12.0V)
Current Channel	UNSYNC		
Current TDM	UNSYNC (144)		Water Temperature DEG
MES Status	Idle		Water Current
GPS Status	ACQ		Direction DEG
			Speed kn
DCE Memory	32818 Bytes free	Depth	
Current State: IDLE		UNSYNC	ANT V abnormal.
		NCS: AORE	Invalid MES ID
TROUBLE: ANT power voltage			Sync loss.
			Total 11. F12:All alert list

When no alert has occurred, the following indication appears.

File Edit Transmit EGC Reports Logs Options Setup Distress StopAlarm			
			IMN: 443156710
Date	19-07-18	BBER	000
Time	22:40 (UTC)	C/N	NG (0 dB)
		Send Level	OK (0)
Position	LAT	Rx AGC Level	OK (254)
	LON	REF Offset Freq	NG (146 Hz)
Waypoint	LAT	Synthe Local	OK
	LON	TCXO Control	2161
Course	DEG		
Speed	kn		
Current NCS	144 (AORE)	LOGOUT	Antenna Power Supply OK(8.6V)
Current Channel	Retuning		
Current TDM	UNSYNC (144)		Water Temperature DEG
MES Status	Idle		Water Current
GPS Status	****		Direction DEG
			Speed kn
DCE Memory	32818 Bytes free	Depth	
			No alert
Current State: IDLE		Retuning	19-07-18 22:40 (UTC)
		NCS: AORE	LOGOUT
DCE F18 Ver. 01			

2.6 Menu Overview

Operation of the FELCOM is done through a menu system which you access with the function keys (see section 2.2.3) at the top of the screen. The example below shows how to select menu options from the [Editor Setup] menu.

1. Press the **F8** key to display the [Setup] menu.

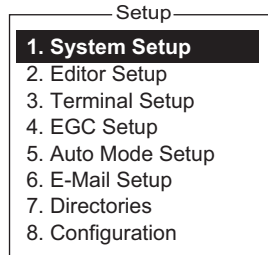

2. Select desired menu by pressing appropriate numeric key. For example, press the **2** key to show the [Editor Setup] menu. (You can also select a menu with the \uparrow and \downarrow keys. Press the **Enter** key after making a selection.)

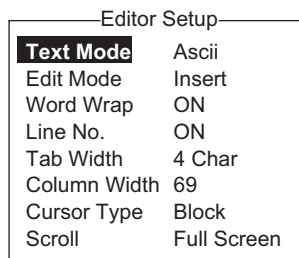

3. Choose a desired menu item by pressing the \uparrow or \downarrow key followed by the **Enter** key. A window displaying the options for the item selected or an alphanumeric data entry window appears depending on your selection. For example, the window at right shows the options for [Word Wrap].
4. Press the \uparrow or \downarrow key to select option desired and press the **Enter** key.
5. Long-press the **Esc** key to return to the standby display.



Note 1: On some menus the [Update] window appears after you press the **Esc** key. This is done to ask you to confirm settings. [Yes] is selected; press the **Enter** key to register settings, or press [\rightarrow] to select [No] and press the **Enter** key to escape. If invalid data is entered, an applicable error message appears and the previous setting is restored.

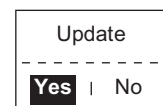

Note 2: On the [System Setup] menu, the message "Wait..." appears (white characters on purple background) while a process is being done. The message disappears once the process is completed.

Wait...

Note 3: To return to the standby display at any time (except the message preparation screen), long press the **Esc** key.

2.7 Error Messages and Alerts

The terminal unit displays error messages and alerts, in the CAUTION window, to call your attention to mis-operation, failed operation and system error. A list of error messages appears in section 10.7 and alerts appear in the Appendix 2.

To erase an error message or alert, press the **Esc** key.

Sent Message						
No.	Message File	Destination	LES	Priority	Send Status	Delivery
CAUTION						
No Message.						
<Press ESC key to continue>						

2.8 How to Use a PC as a Sub Terminal

A PC can be used as a sub terminal. The sub terminal sole function is communications; initial settings, etc. are done from the main terminal.

PC terminal software

Type: OP16-57, Code No.: 001-180-050

PC requirements

- Operating system: Windows® 7, Windows® 8, Windows® 10 or Windows® 11
- RAM: At least 512 MB (1GB or more is recommended)
- Hard disk: At least 1 GB free space
- CPU: 1 GHz processor or faster
- CD-ROM drive

2.8.1 How to install the software

1. Turn on the PC.
2. Set the installation CD-ROM in the CD drive of the PC.
3. Click the icon of SETUP. EXE.

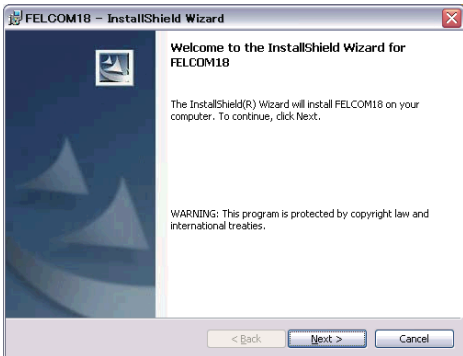

2. OPERATIONAL OVERVIEW

- Click the [Next] button. Enter user name and organization. Click the applicable radio button at the bottom of the screen.

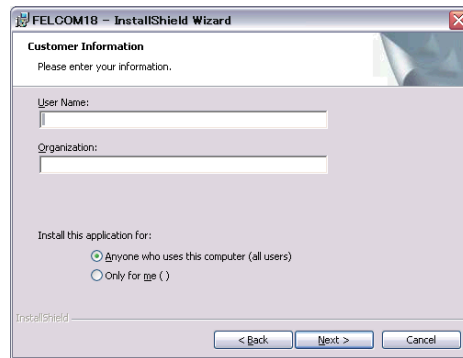

- Click the [Next] button.



- Click the [Next] button.

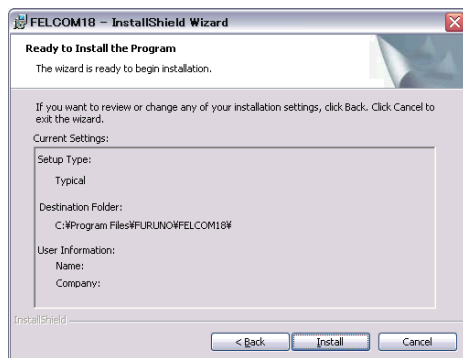

- Click the [Install] button to start the installation. When the installation is completed, the FELCOM dialog box appears.

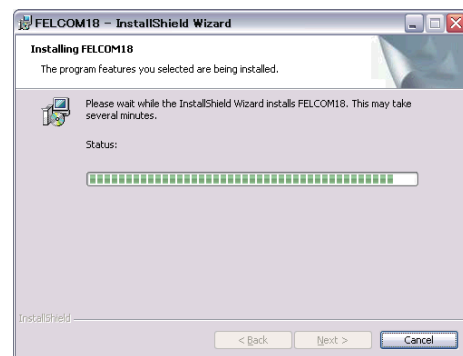

- Click the [Close] button at the top right corner of the dialog box. The [Setup Complete] dialog box appears.

Note: If you want to launch the program now, click the box next to "Yes, launch the program file." The application launches after the completion of step 9.

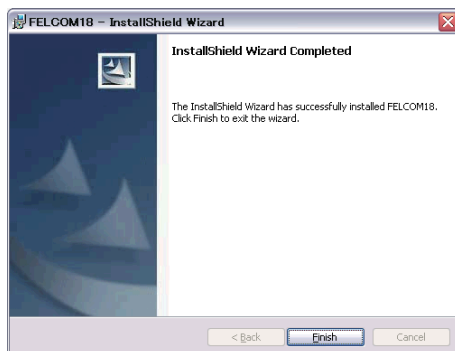

9. Click the [Finish] button. The FELCOM application shortcut is created on the desktop of the PC.

2.8.2 How to start, quit the application

1. Turn on the terminal unit.
2. Turn on the PC.
3. Double-click the FELCOM icon to start the application.
4. To quit the application, press the **F12** key while pressing the **Alt** key. (You may also quit the application by clicking the Close button.) Then, the window shown right appears.
5. Press the ← key to select [Yes] and then press the **Enter** key.
6. Turn off the PC according to the Windows operating procedure.
7. Turn off the terminal unit.

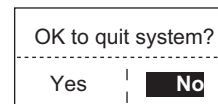

Note 1: If the application is quit using a method different from that described above newly changed settings will not be memorized.

Note 2: The procedures described in this manual are intended for use with the terminal unit. Operation from a PC is similar, however key names, etc. may be different and some functions are not available. The functions not available with a PC are as follows:

<u>Keying sequence</u>	<u>Function not available with PC</u>
F3-1	Distress priority selection on Transmit Message
F7-1	Position
F7-2	Login
F7-3	Logout
F7-4	Abort (forced clearing)
F7-5	Select NCS (selection of NCS common channel)
F7-6	Ocean Region (selection of ocean region)
F7-8	Functions other than [PV Test Result] and [Diagnostic Test] on [Test] Menu
F8-1	Functions other than [IMN] on [System Setup] menu
F8-3	[EGC Channel List] on [Configuration] menu
F8-4	[NCS Channel List] on [Configuration] menu

2.8.3 How to select the printer to use

1. Press the **F1** key to open the [File] menu.
2. Press the **8** key to open the [Print Setting] window.

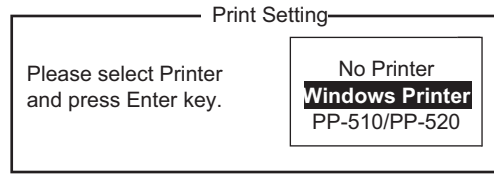

File	
1. New	ALT-N
2. Open	ALT-O
3. Close	ALT-Q
4. Save	ALT-S

5. Delete	ALT-D
6. Rename	

7. Print	ALT-P

8. Print Setting	

9. MIME (Decode)	

3. Select appropriate printer.
No Printer: Select if no printer is connected.
Windows Printer: Select if a PC printer is connected.
PP-510/P-520: Select if the PP-510 or PP-520 is connected.
4. Press the **Enter** key to finish.

2.8.4 How to back up the system to PC or storage media

System data can be backed up to the selected folder on the PC's hard drive or a storage media (SD card).

1. If you are exporting settings to a storage media, insert the media in its drive.
2. Press the **F8**, **8** and **6** keys to show the [Export/Import] menu.
3. Select [Export] then press the **Enter** key.



4. Select the item to export then press the **Enter** key.
Sent Message: Export a maximum of 50 sent messages. The messages are saved to the SD card under the original file name.
Received Message: Export a maximum of 50 received messages. The messages are saved to the SD card under the original file name.
EGC Message: Export a maximum of 50 EGC messages. The messages are saved to the SD card under the original file name.
Station List: Export the Station List.
LES List: Export the LES List.
E-Mail/SMS Service List: Export the [E-mail/SMS Service List].
Test: Export a maximum of five each of PV test and diagnostic test.
Maintenance: Export a maximum of 5000 entries of the [Current Position Log].
Settings: Export settings of SSAS, EGC, Network and Terminal Unit.
5. The [Browse for folder] dialog box appears. Select the destination where to export the settings then click the [OK] button. The message "OK to Export?" appears.
6. Select [Yes] then press the **Enter** key.
7. Press the **Esc** key several times to return to the main menu.

3. SYSTEM INITIALIZATION

This chapter shows you how to initialize the FELCOM system. Once the equipment is initialized, you need do no more than press a few keys to get fully automatic transmission and reception.

Inmarsat assigns an MES (your ship) an Inmarsat Mobile Number (IMN) when it applies for Inmarsat registration. The IMN is necessary to communicate in the Inmarsat system and It is entered into the FELCOM system during the installation.

3.1 System Settings

3.1.1 Confirm the main terminal

The main terminal is where you set up the system. (You cannot set up the system from an external terminal.) Confirm that the main terminal is selected as below.

1. Press the **F8** key to show the [Setup] menu.

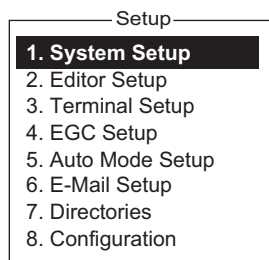

If your screen looks something like the one shown in the illustration above, you are using the main terminal. (If you are using an external terminal, some menu items appear in gray.)

3.1.2 System setup

The [System Setup] menu is where you enter the date, time, operating mode, and port function.

1. Press the **F8** and **1** keys to show the [System Setup] menu.

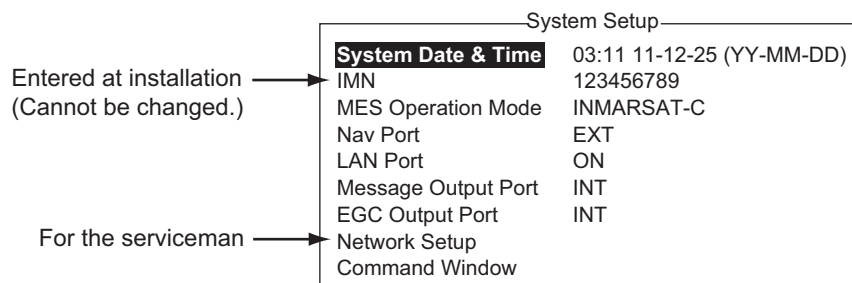

2. [System Date & Time] is selected; press the **Enter** key to open the date entry window.
3. Enter the date with the numeric keys. (Entry of date is not necessary if a GPS navigator is connected to the FELCOM.)

3. SYSTEM INITIALIZATION

4. Press the **Enter** key to close the window. (Note that the IMN is entered during installation. The IMN window cannot be opened.)
5. Select [MES Operation Mode] then press the **Enter** key to show the MES Operation window.
6. Select an operating mode, [INMARSAT-C] or [EGC]. The INMARSAT-C setting provides telex communications and operates as an EGC receiver when the equipment is not transmitting or receiving. The EGC setting enables EGC-only operation. In this case, "Current State: EGC RECEIVER" appears (reverse video) at the bottom of the screen.
7. Press the **Enter** key to close the window.
8. Select [NAV Port] then press the **Enter** key.
9. Select the navigator connected to the FELCOM then press the **Enter** key.
OFF: Manually input the position of own ship. Alarm is outputted when the position data is not updated every four hours.
Auto: INT or EXT is automatically selected. For SSAS Russia and LRIT Russia, the setting of [NAV Port] is fixed at Auto and GLONASS is prioritized.
INT: Use the navigator that is built into the terminal unit.
EXT: Use an external navigator.

Note: If the system is not fitted with the internal GPS receiver and there is no external GPS receiver, turn off the [NAV PORT] setting and enter position manually, on the [Position] menu. See section 3.8.
10. Select [LAN Port] then press the **Enter** key.
11. Select [ON] to enable LAN interface or [OFF] to disable it then press the **Enter** key.
12. Select [Message Output Port] then press the **Enter** key.
13. Select the destination for sent messages then press the **Enter** key.
INT: Output messages to the main terminal.
LAN: Output messages to the LAN. ([LAN Port] set to [ON])
INT+LAN: Output messages to both the main terminal and the LAN. ([LAN Port] set to [ON])
AUTO: All received messages are output according to the message sub address.
14. Select [EGC Output Port] then press then **Enter** key.
15. Select where to route received EGC messages then press the **Enter** key.
INT: Output EGC messages to the main terminal.
LAN: Output EGC messages to the sub terminal or other navigation device connected to the LAN Port on the main terminal.
INT+LAN: Output EGC messages to the main terminal, sub terminal and other navigation device.
16. Press the **Esc** key to open the [Update] window.
Note: [Network Setup] provides network initial settings. [Command Window] is no use.
17. [Yes] is selected; press the **Enter** key to update the system settings.
18. Long-press the **Esc** key to return to the standby display.

3.2 Terminal Setup

The [Terminal Setup] menu provides for selection of connection point, date display format, screen saver on/off and window colors.

1. Press the **F8** and **3** keys to show the [Terminal Setup] menu.

Terminal Setup	Terminal Setup
<div style="background-color: black; color: white; padding: 2px;">Date Disp. Form DD-MMM-YY</div> Screen Saver OFF Window Color	<div style="background-color: black; color: white; padding: 2px;">Connection</div> Date Disp. Form DD- MMM-YY Screen Saver OFF Window Color Window Size Normal
<i>1C-218</i>	<i>2nd DTE</i>

2. **For a 2nd DTE**, do steps 1) - 2) below. Otherwise, skip to step 3.

- 1) Select [Connection] then press the **Enter** key to show the [Connect List]. The [Connect List] shows the names of the FELCOM 18 terminals available for communication.

Connection List				
No.	Name	IMN	IP Address	Software Version
01	F18_123456	123432588	172.31.16.2	1650247-xx
02	F18_133234	456789210	192.168.16.2	1650247-xx
03				
04				
05				
06				
07				
08				
09				
10				
	Other			

Note: The No., Name, IMN, IP address/subnet mask and software version of each terminal are shown. The asterisk marks the FELCOM 18 terminal currently selected for communication.

- 2) Select the FELCOM 18 terminal to connect then press the **Enter** key.
3. Select [Date Disp. Form] then press the **Enter** key to open its options window.
4. Select [YY-MM-DD], [MMM-DD-YY] or [DD-**MMM-YY**] as appropriate then press the **Enter** key.
5. Select [Screen Saver] then press the **Enter** key.
6. Turn the screensaver ON or OFF as appropriate then press the **Enter** key. When enabled, the screensaver automatically starts 10 minutes after there is no key operation. To release the screensaver, press any key.

3. SYSTEM INITIALIZATION

7. Select [Window Color] then press the **Enter** key. (The 2nd DTE does not have the menu item [Brightness].)

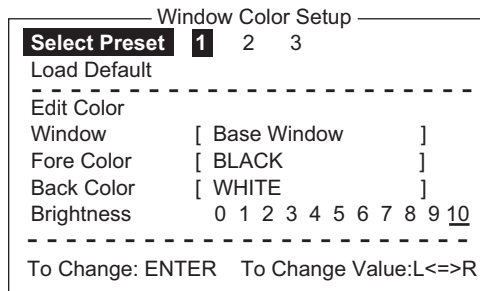

8. Set the window colors as follows:
 - 1) [Select Preset] provides three preconfigured window color sets. Use one of these sets, or continue this procedure to customize window colors. Preset 1 and 2 are daytime modes (bright environment), and Preset No.3 is for night-time use (dark environment).
The brightness setting for each preset is as follows:
Preset 1: Brightness 10
Preset 2: Brightness 10
Preset 3: Brightness 5
 - 2) Select [Window]. Use ← or → key to select the window for which to select color.
Base Window: Standby display
RCV Message Display: Receive message display
EGC Message Display: EGC message display
EDIT1 - EDIT2: Editor screens 1 and 2
Function: Menu
Sub Menu 1 - Sub Menu 4: Sub menus 1-4
Message: Status message

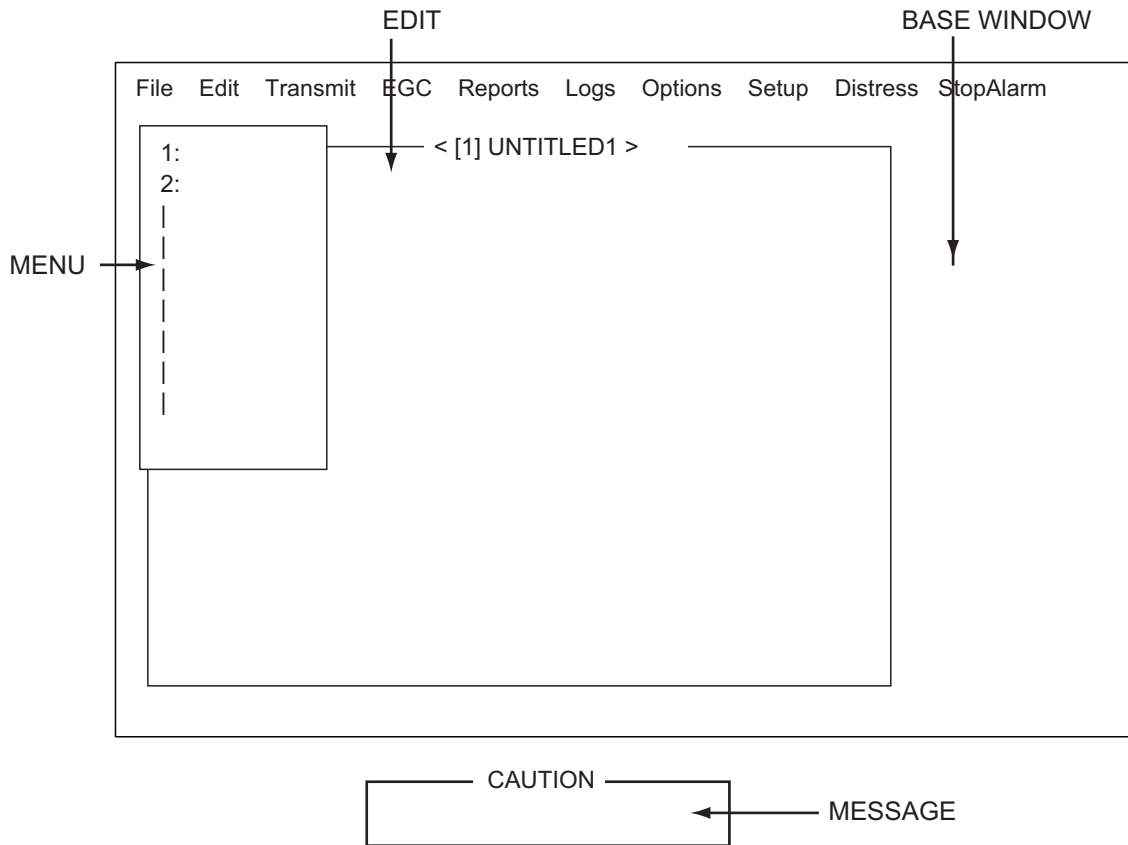

- 3) Select [Fore Color].
 - 4) Use ← or → key to select a color.
 - 5) Select [Back Color].
 - 6) Use ← or → key to select a color.
 - 7) To select colors for other windows repeat steps 2)-6).
 - 8) [Brightness] shows current brightness setting. For how to adjust brightness, see section 2.1.2. See the table on the next page for the default settings for each preset.
- Note:** To restore all default color settings, select [Window Color Setup] from the [Terminal Setup] menu, select [Load Default], press the **Enter** key then press the **Enter** key again.

3. SYSTEM INITIALIZATION

Preset No.	Window	Fore Color	Back Color	Bright-ness
1	Base Window	L-WHITE	BLUE	10
	RCV Message Display	WHITE	BLACK	
	EGC Message Display	WHITE	BLACK	
	EDIT 1	BLACK	GREEN	
	EDIT 2	MAGENTA	WHITE	
	Function	BLACK	CYAN	
	Sub Menu 1	BLACK	WHITE	
	Sub Menu 2	BLUE	WHITE	
	Sub Menu 3	L-WHITE	BLACK	
	Sub Menu 4	WHITE	BLACK	
	Message	WHITE	MAGENTA	
2	Base Window	BLACK	L-WHITE	10
	RCV Message Display	BLACK	WHITE	
	EGC Message Display	BLACK	WHITE	
	EDIT 1	BLACK	WHITE	
	EDIT 2	BLACK	L-CYAN	
	Function	BLACK	WHITE	
	Sub Menu 1	BLUE	L-WHITE	
	Sub Menu 2	BLUE	WHITE	
	Sub Menu 3	L-WHITE	BLUE	
	Sub Menu 4	WHITE	BLACK	
	Message	L-WHITE	BLUE	
3	Base Window	L-WHITE	BLACK	5
	RCV Message Display	BLACK	GRAY	
	EGC Message Display	BLACK	GRAY	
	EDIT 1	BLACK	GRAY	
	EDIT 2	WHITE	BLUE	
	Function	L-WHITE	BLACK	
	Sub Menu 1	L-CYAN	BLACK	
	Sub Menu 2	L-GREEN	BLACK	
	Sub Menu 3	L-MAGENTA	BLACK	
	Sub Menu 4	WHITE	BLACK	
	Message	WHITE	BLUE	

- 9) Press the **Enter** key to show the [Update] window.
- 10)[Yes] is selected; press the **Enter** key.
Note: To restore all default color settings, select [Window Color Setup] from the [Terminal Setup] menu, select [Load Default], press the **Enter** key then press the **Enter** key again.
9. If a 2nd DTE is used, select [Window Size] then press the **Enter** key to select window size. Otherwise, skip to step 10.
 - 1) Select [Normal] or [Large] as appropriate.
[Normal]: 800(H)×600(V)
[Large]: 1200(H)×900(V)
 - 2) If you changed the size, the message "Please Restart." appears. Exit the PC terminal and restart the terminal to reflect the change.
10. Long-press the **Esc** key to return to the standby display.

3.3 Login and Logout

Each time the terminal unit is turned on, login your vessel with the Inmarsat C system to enable communications between your vessel and an LES. This is called login. Note that you can transmit the distress alert or receive EGC messages even if you are not logged in. If you will not be using the FELCOM for a prolonged period, you should log out from the Inmarsat C system, before turning off the terminal unit. The Inmarsat C system will then register you as inactive, notifying anyone trying to call you that you are currently unavailable. If you do not log out before turning off the power, some LESs may attempt to send a message to you. They may charge your correspondent, even if you don't receive the message.

3.3.1 Login

1. Confirm that [SYNC (NCS)] appears at the bottom of the screen.
2. Press the **F7** key to display the [Options] menu.

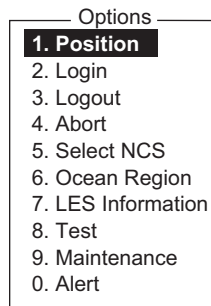

3. Press the **2** key to display the [Login] screen.

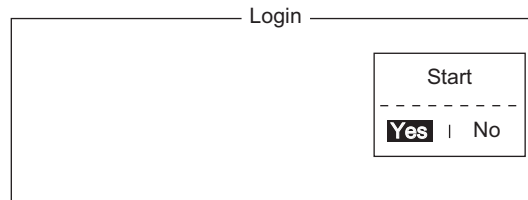

Note: The terminal unit must be "idle" to login. ("Current State: IDLE" appears at the bottom of the screen.) When it is not idle, "Ignored: MES is not idle." appears. Long-press the **Esc** key to return to the standby display. Wait until the terminal unit becomes idle.

4. [Yes] is selected in the [Start] window; press the **Enter** key.

- Login begins, and the screen should look something like the one shown below.

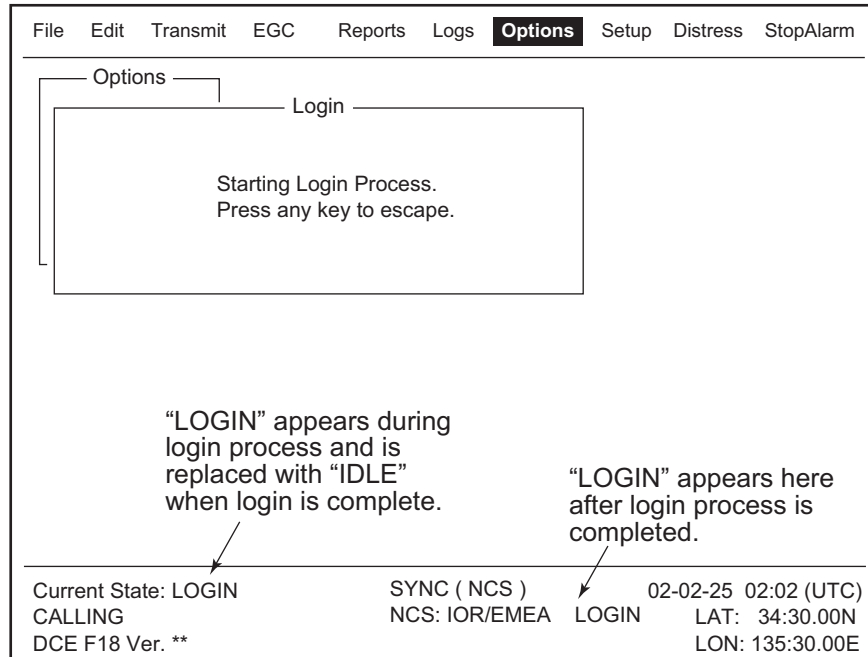

When login is completed, the message "Successful Login." appears. Then, the system goes into "Idle" status.

- Long-press the **Esc** key to return to the standby display.

3.3.2 Logout

- Press the **F7** and **3** keys to display the [Logout] screen.

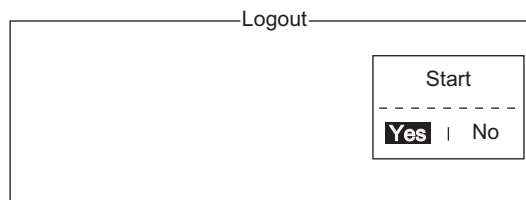

- [Yes] is selected in the [Start] window; press the **Enter** key. The message "Starting Logout Process. Press any key to escape." appears.
- When logout is completed, the message "Successful Logout." appears and the [Current State] indication changes from [LOGOUT] to [IDLE]. Then, turn off the FELCOM.

3.4 EGC Settings

3.4.1 What is the EGC (Enhanced Group Call) service?

The EGC service enables EGC information providers to send SafetyNET™, FleetNET™ and System messages via an LES to a specific groups of ships, or to all ships within a defined geographical area.

Each type of EGC service is sent as follows:

- The information provider prepares the message, and then accesses the appropriate Country of the international telex network to send the message to an LES.
- The LES processes and forwards it to the NCS for the ocean region designated by the provider.
- Then, the NCS broadcasts the message throughout the ocean region. (The operator may select the EGC messages to receive by position (one position) and geographical position (nine areas). For further details see section 3.4.2.

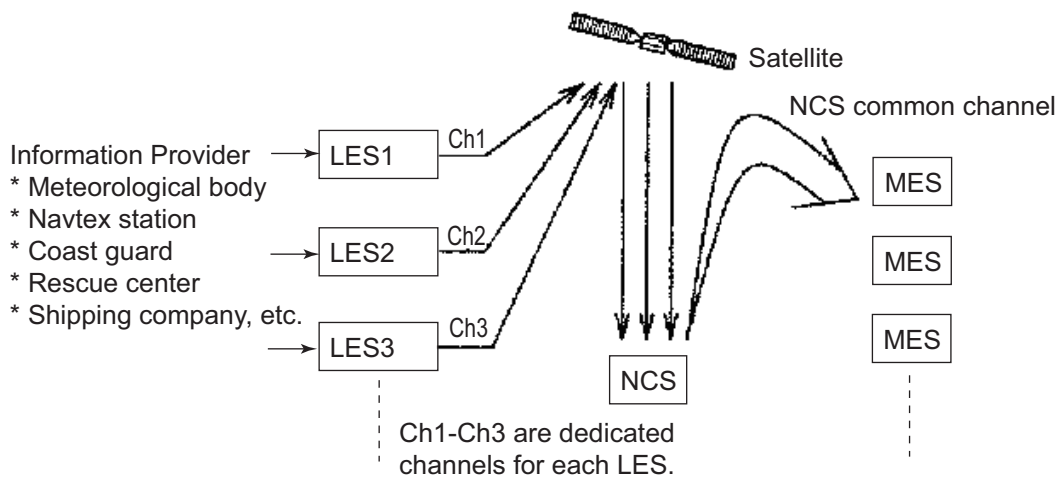

There are three types of EGC services:

1) SafetyNET™

This provides a means for information providers to distribute Maritime Safety Information (MSI) from shore-to-ship. Authorized information providers include:

- Hydrographic Offices, for navigational warnings
- National Weather Services, for meteorological warnings and forecasts
- Rescue Co-ordination Center, for shore-to-ship distress alerts and other urgent information
- International Ice Patrol, for North Atlantic ice hazards

2) FleetNET™

This service allows authorized information providers such as commercial subscription services, shipping companies and governments, which have registered with a LES that supports FleetNET™, to broadcast messages to selected group of MESs. Typical applications of FleetNET™ are

- Fleet or company broadcasts
- News broadcasts
- Commercial weather service
- Government broadcasts to all vessels on a country's registration

- 3) System: EGC system-related is sent by Inmarsat to certain ship groups and geographical areas.

3.4.2 EGC settings

The FELCOM receives EGC messages directed to its present position and Navarea without further programming. The [EGC Setup] screen lets you select additional areas for which to receive messages and also the Navtex station and type of message for Coastal Warning (NAVTEX Re-broadcast).

1. Press the **F8** and **4** keys to display the [EGC Setup] menu.

EGC Setup			
Receive EGC Area			
Additional Position			----
Navarea(s)/Metarea(s)			-----
Fixed Area			-----
Waypoint (from NAV Equipment)	ON		

Coastal Warnings			
Station Code			
Type of Message (Can't reject other report)			
Ice reports	OFF	SATNAV messages	OFF
Pilot service	OFF	Other navaid msg	OFF
AIS messages	OFF	QRU (no message)	OFF
LORAN messages	OFF		

2. The cursor is selecting [Additional Position], where you can enter the L/L position of an ocean region you want to receive broadcasts about. Press the Enter key to open the additional position entry window.
3. Enter position as follows:
 - 1) Enter latitude (xx°xxx).
 - 2) Press the **N** or **S** key as appropriate to enter coordinate.
 - 3) Enter longitude (xxx°xxx).
 - 4) Press the **E** or **W** key as appropriate to enter coordinate.
4. Press the **Enter** key to close the window.
5. Select [Navarea(s)/Metarea(s)] and press the **Enter** key to open the nav area entry window.

3. SYSTEM INITIALIZATION

6. Enter additional Navarea(s) (I-XXI, max. of nine) in two digits, referring to the illustration below for code number.

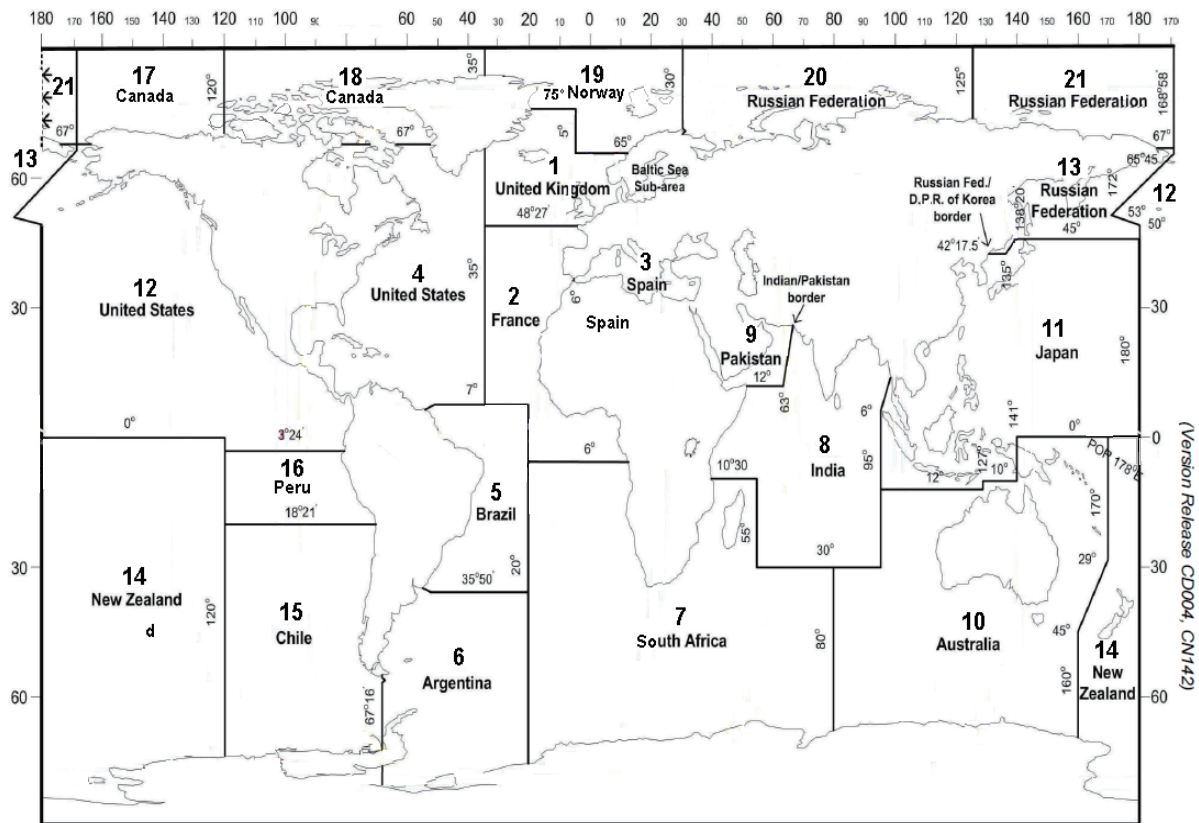

7. Press the **Enter** key to close the window.
Note: [Fixed Area] is where you enter fixed areas (max. 3) for chart correction service. However, this service is not yet available; enter no data.
8. Select [Waypoint] then press the **Enter** key.
9. Choose [ON] to receive broadcasts for the area which contains the destination waypoint set on the navigator. Press the **Enter** key to close the window.
10. Select [Station Code] then press the **Enter** key.
11. Enter the Navtex station code (A-Z) of the navarea, in upper case alphabet. For details about Navtex stations, consult the operator's manual of the Navtex receiver. Press the **Enter** key to close the window.
12. Select the message type to receive: Use the arrow keys to select message type, press the **Enter** key, select [ON] or [OFF] as appropriate then press the **Enter** key.
Note: The Navtex messages "Coastal navigational information," "Meteorological warning" and "Search and rescue alert" (they do not appear on the [EGC Setup] menu) must always be received.
13. Press the **Esc** key to show the [Update] window.
14. [Yes] is selected; press the **Enter** key.
15. Long-press the **Esc** key to return to the standby display.

3.4.3 How to add EGC channels

The EGC Channel List stores EGC channels. There are currently four EGC channels, one for each satellite. These four channels are pre-programmed into the unit and marked in the [EGC Channel List] with asterisks. When more EGC channels become available you can add them to the list as below.

1. Press the **F8**, **8** and **3** keys to show the [EGC Channel List].

EGC Channel List			
ENTER: Set ESC: Quit			
-----+	-----+	-----+	-----+
11080*	12580*	10840*	11088*

2. Use the arrow keys to put the cursor where there is no data entered. Current EGC channels are marked with an asterisk. These channels cannot be changed.
3. Press the **Enter** key to open the EGC channel list entry screen.
4. Enter EGC channel frequency code then press the **Enter** key. The EGC channel frequency code range is 6000-14000.
5. Press the **Esc** key to open the [Update] window.
6. [Yes] is selected; press the **Enter** key.

Note: If the EGC channel frequency code entered is invalid, the message "Input Error: Channel No." appears. Clear the error message by pressing the **Esc** key. Put the cursor at the invalid frequency, press the **Enter** key then enter correct frequency code.
7. Long-press the **Esc** key to return to the standby display.

3.4.4 How to automatically save and print EGC messages

How to automatically save EGC messages

1. Press the **F8** and **5** keys to display the [Auto Mode Setup] menu.

Auto Mode Setup	
Auto Communication Log Print	OFF
Receive Alarm	OFF
Auto Receive Message Save	OFF
Auto Receive Message Print	OFF
Data Report & Polling Print	OFF
Auto EGC Message Save	
Auto EGC Message Print	

2. Select [Auto EGC Message Save] then press the **Enter** key.

Auto EGC Message Save	
System	OFF
FleetNET	OFF
SafetyNET (Safety)	OFF
SafetyNET (Urgent & Distress)	ON

3. Select the message to process then press the **Enter** key.
4. Select [ON] or [OFF] as appropriate then press the **Enter** key.
5. Long-press the **Esc** key to return to the standby display.

How to automatically print EGC messages

FleetNET™ and SafetyNET™ messages can be automatically printed.

1. Press the **F8** and **5** keys to display the [Auto Mode Setup] menu.
2. Select [Auto EGC Message Print] then press the **Enter** key.

Auto EGC Message Print	
System	OFF
FleetNET	OFF
SafetyNET (Safety)	OFF

3. Select the message to process then press the **Enter** key.
4. Select [ON] or [OFF] as appropriate then press the **Enter** key.
5. Long-press the **Esc** key to return to the standby display.

3.5 How to Add NCS Channels

This section shows you how to add NCS channels to the [NCS Channel List]. 19 channels can be listed per each ocean region. Currently, there are four NCS channels, and they are marked with asterisks in the list. Add NCS channels to the list as below when they become operational.

1. Press the **F8**, **8** and **4** keys to display the [NCS Channel List].

NCS Channel List								
ENTER: Set ESC: Quit								
No	AORW/AMER	AORE		POR/APAC		IOR/EMEA		
	ID	FREQ	ID	FREQ	ID	FREQ	ID	FREQ
01	044	11080*	144	12580*	244	12580*	344	10840*
02	0		1		2		3	
03	0		1		2		3	
04	0		1		2		3	
05	0		1		2		3	
06	0		1		2		3	
07	0		1		2		3	
08	0		1		2		3	

2. Use the arrow keys to put the cursor in a blank [ID] column.
3. Press the **Enter** key to open the data entry window.
4. Enter NCS channel ID number, in two digits (leading zero is not necessary). The ID number range is 45-63.
5. Press the **Enter** key to close the window.
6. Press the **→** key to select the [FREQ] column then press the **Enter** key to open the frequency input window.
7. Enter NCS channel frequency code. The frequency code range is 6000-14000.
8. Press the **Enter** key to close the window.
9. Press the **Esc** key to open the [Update] window.
10. [Yes] is selected; press the **Enter** key to register input.

Note: If the ID or frequency code entered is invalid the message "Input Error: NCS ID" (for invalid ID) or "Input Error: Channel No." (for invalid frequency code) appears. Clear the error message by pressing the **Esc** key. Put the cursor at the invalid ID or frequency code. Then, press the **Enter** key and enter correct ID or frequency code.
11. Long-press the **Esc** key to return to the standby display.

3.6 LES List

The LES List provides for storage of 44 LES names per ocean region.

3.6.1 How to register an LES to the LES list

When a new LES is added, add it to the [LES List] as shown below. See the Appendix 4 for a list of LES.

1. Press the **F8**, **8** and **2** keys to display the [LES List].
2. Use the arrow keys to put the cursor where desired. For example, select 006 in the AOR(WEST) column.

LES List				
Ctrl+I: Initialize Ctrl+P: Print ENTER: List Entry ESC: Quit				
No	AOR(WEST) Name	AOR(EAST) Name	POR Name	IOR Name
00				
01	Vizada 001	Vizada 101	Vizada 201	Vizada 301
02	Stratos Global	Stratos Global	Stratos Global	Stratos Global
03	KDDI	KDDI	KDDI	KDDI
04	Vizada (NOR)	Vizada (NOR)	Vizada (NOR)	Vizada (NOR)
05	Telecom Italia	Telecom Italia	Telecom Italia	Telecom Italia
06	██████████			
07				

LES ID: XXX

↑
No. (00-43)

0: AOR(WEST)
1: AOR(EAST)
2: POR
3: IOR

↑
Put cursor here.

3. Press the **Enter** key.

Name	:	
ID	:	006
Remarks	:	

Erase the Name to delete this LES.		

4. [Name] is selected; press the **Enter** key to open the text entry window.
5. Enter LES name (maximum 15 characters) then press the **Enter** key.
6. Select [Remarks] then press the **Enter** key.
7. Enter remarks (max. 20 characters) then press the **Enter** key.
8. Press the **Esc** key to return to the [LES List].
9. Repeat steps 2-8 to enter another LES.
10. Long-press the **Esc** key to return to the standby display.

3.6.2 How to edit the LES list

1. Press the **F8**, **8** and **2** keys to display the [LES List].
2. Select the LES to edit then press the **Enter** key.
3. Do one of the following:
Change station name: Select [Name] then press the **Enter** key. Press the **Back-Space** key to erase name, enter new name then press the **Enter** key.
Delete station name: Select [Name] then press the **Enter** key. Press the **Back-Space** key to erase name then press the **Enter** key.
4. Press the **Esc** key to quit.
5. Long-press the **Esc** key to return to the standby display.

3.6.3 How to restore the default LES list

1. Press the **F8**, **8** and **2** keys to display the [LES List].
2. Press the **I** key while pressing the **Ctrl** key. The message "Restore to default LES List." appears.
3. Select [Yes] then press the **Enter** key to restore the default LES list.

3.6.4 How to print the LES list

1. Press the **F8**, **8** and **2** keys to display the [LES List].
2. Press the **P** key while pressing the **Ctrl** key.
3. Long-press the **Esc** key to return to the standby display.

3.7 Station List

3.7.1 How to add stations to the station list

The FELCOM provides an address book for storing 99 station IDs. Enter station IDs as shown below.

1. Press the **F8**, **8** and **1** keys to display the [Station List].

Station List			
Group	Station Name	Type	Code ID / Address
01	abc	E-Mail	abc@furuno.co.jp
02	xyz	E-Mail	xyz@furuno.co.jp
03	Seagull	TELEX/	584 463609999
04			
05			
06			
07			
08			

Page Up, Page Down: Move Ctrl+P: Print
Sort (Ctrl+G: Group, Ctrl+N: Station Name, Ctrl+T: Type)

Note: You may sort the list by group name, station name or communication type as follows:

Group name: Each press of **Ctrl+G** sorts the list by group name, in ascending or descending order.

Station name: Each press of **Ctrl+N** sorts the list by station name, in ascending

3. SYSTEM INITIALIZATION

or descending order.

Comm. type: Each press of **Ctrl+T** sorts the list by communication type, in ascending or descending order.

2. Press the ↓ key to put the cursor on a blank line then press the **Enter** key.

Station Group	
Station Name	
Destination Type	TELEX/MES
Prefix Code	
Country Code	
Station ID	
Modem Type	
E-Mail Address	
Remarks	

Erase the Name to delete this station.	

3. Press the **Enter** key to open the station group entry window.
4. Enter station group name (max. five characters) then press the **Enter** key.
5. Select [Station Name] then press the **Enter** key.
6. Enter station name then press the **Enter** key.
7. Select [Destination Type] then press the **Enter** key.

TELEX/MES	
FAX	
E-Mail	
SMS	
PSDN	
X400	
DNID	
Special	
TELEX/MES	(Prefixed)
FAX	(Prefixed)
PSDN	(Prefixed)
X400	(Prefixed)
DNID	(Prefixed)
Special	(Prefixed)

8. Select destination type desired then press the **Enter** key.
TELEX/MES: Telex communication/Mobile Earth Station (ship-to-ship Telex)
FAX: Facsimile service
E-Mail: E-mail (electronic mail) Service
SMS: Short Message Service.
PSDN: Public Switched Data Network to an office computer via a data network using X.25 standard.
X400: For future use
DNID: Data Network ID. Not used.
Special: Ship-to shore requests for safety service, accessed by using special 2-digit codes
9. Follow appropriate procedure on the next several pages.

Procedure for telex

1. Select [Country Code] then press the **Enter** key.
2. For ship-to-shore telex, enter international telex country code; for ship-to-ship telex, enter ocean region. Press the **Enter** key. A list of international telex country codes appears in the Appendix 4.
AOR-East: 581, POR: 582, IOR: 583, AOR-West: 584
3. Select [Station ID] then press the **Enter** key.

4. Enter telex subscriber number (for ship-to-shore) or MES Inmarsat Mobile Number (for ship-to-ship) then press the **Enter** key. A maximum of 15 characters can be used, including space.
5. Select [Remarks] then press the **Enter** key.
6. Enter remarks then press the **Enter** key. A maximum of 20 characters can be used.
7. Press the **Enter** key to close the window.
8. Long-press the **Esc** key to return to the standby display.

Procedure for Fax

1. Select [Country Code] then press the **Enter** key.
2. For ship-to-shore fax, enter international country code; for ship-to-ship fax, enter ocean region. Press the **Enter** key. A list of international telex country codes appears in the Appendix 4.
3. Select [Station ID] then press the **Enter** key.
4. Enter the fax number then press the **Enter** key.
5. Select [Modem Type] then press the **Enter** key.

Modem Type		
T30	FAX	
V21	V.21	300bps Duplex
V22	V.22	1200bps Duplex
V22B	V.22bis	2400bps Duplex
V23	V.23	600/1200bps
V26B	V.26bis	2400/1200bps
V26T	V.26ter	2400bps Duplex
V27T	V.27ter	4800/2400bps
V32	V.32	9600bps Duplex
Other		

6. Select the modem type used by the subscriber then press the **Enter** key. For a landline fax or a fax-equipped Inmarsat B MES, select [T30 FAX].
7. Select [Remarks] then press the **Enter** key.
8. Enter remarks then press the **Enter** key. A maximum of 20 characters can be used.
9. Press the **Esc** key to return to the Station List.
10. Long-press the **Esc** key to return to the standby display.

Procedure for e-mail

1. Select [Address] then press the **Enter** key.
2. Enter the e-mail address of the recipient then press the **Enter** key.
3. Select [Remarks] then press the **Enter** key.
4. Enter remarks then press the **Enter** key. A maximum of 20 characters can be used.
5. To enter another e-mail address, repeat the procedure from step 2 on page 3-17.
6. Long-press the **Esc** key to return to the standby display.

Procedure for SMS

1. Select [Address] then press the **Enter** key.
2. Enter the recipient's mobile phone number, beginning with the country code then press the **Enter** key.
3. Select [Remarks] then press the **Enter** key.
4. Enter remarks then press the **Enter** key. A max. of 20 characters can be used.
5. Press the **Esc** key to return to the station list.
6. To enter another SMS recipient, repeat the procedure from step 2 on page 3-17.
7. Long-press the **Esc** key to return to the standby display.

3.7.2 How to edit the station list

1. Press the **F8**, **8** and **1** keys to display the [Station List].
2. Select a station then press the **Enter** key.
3. Do one of the following:
Change station name: Select [Station Name] then press the **Enter** key. Press the **BackSpace** key to erase name, enter new name then press the **Enter** key.
Delete station name: Select [Station Name] then press the **Enter** key. Press the **BackSpace** key to erase name then press the **Enter** key.
4. Press the **Esc** key to save the changes.
5. Long-press the **Esc** key to return to the standby display.

3.7.3 How to print the station list

1. Press the **F8**, **8** and **1** keys to display the [Station List].
2. Press the **P** key while pressing the **Ctrl** key.
3. Long-press the **Esc** key to return to the standby display.

3.8 How to Enter Position

When there is no navigation data or the Nav Port is disabled, enter ship's position manually:

1. Press the **F7** and **1** keys to display the [Ship Position] menu.
2. Press the **Enter** key to open the latitude entry window.
3. Enter latitude (XX°XX.XX), press the **N** or **S** key as appropriate then press the **Enter** key.
4. Select [LON], press the **Enter** key, enter longitude (XXX°XX.XX), press the **W** or **E** key as appropriate then press the **Enter** key.
5. Select [Update Time] then press the **Enter** key. Enter the current time then press the **Enter** key.
6. Press the **Esc** key to open the [Update] window [Yes] is selected; press the **Enter** key to update position and close the menu.

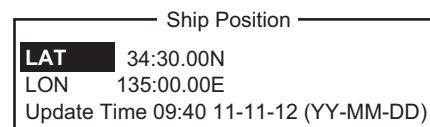

The position entered appears at the bottom right corner of the system status monitor screen. It is also entered on [Update Distress Alert] screen (see Chapter 7).

3.9 How to Create a Directory

You can create and specify the directory where to save incoming and outgoing messages, to an SD card or the internal memory. The directory lets you save and organize your messages conveniently.

3.9.1 How to create a directory for message storage

1. To make a directory in an SD card, insert an SD card in the SD card slot.
2. Press the **F8** and **7** keys to open the [Directories] menu.
3. Select [Message Directory] then press the **Enter** key.

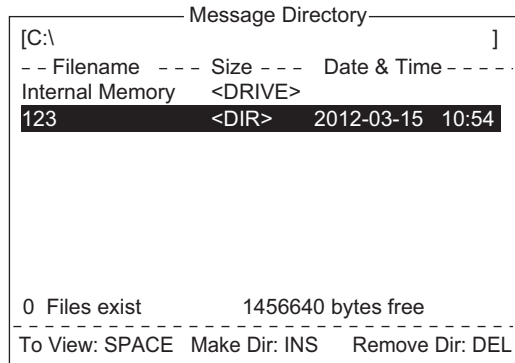

Note: The drive for an SD card is “C” and the drive for the internal memory is “A”. To switch between the drives, select the <DRIVE> line then press the **Enter** key.

4. Press the **Insert** key to show the [Make Directory] window.
5. Enter directory name then press the **Enter** key.

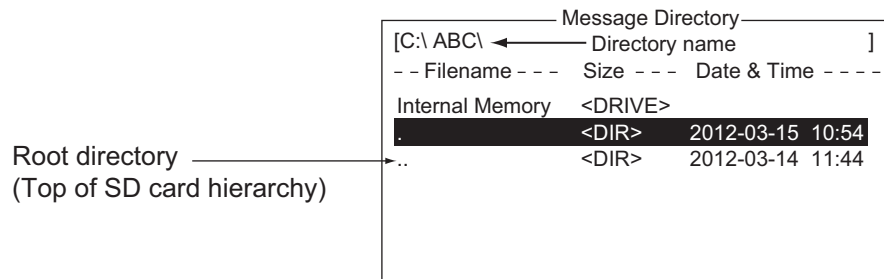

Note 1: To create a directory within a directory (at step 5), repeat steps 4 and 5.

Note 2: To return to the root directory, place the cursor on [. .] then press the **Enter** key.

6. Press the **↑** key.
7. Press the **Esc** key to show the [Update] window.
8. [Yes] is selected; press the **Enter** key.
9. Long-press the **Esc** key to return to the standby display.

Received messages are saved to the directory created here.

A directory for EGC message storage can also be made. Select [EGC Message Directory] at step 3.

3.9.2 How to specify the directory for message storage

1. Press the **F8** and **7** keys to open the [Directories] menu.
2. Select [Message Directory] then press the **Enter** key. (If necessary, switch the drive, C for SD card, A for the internal memory.)

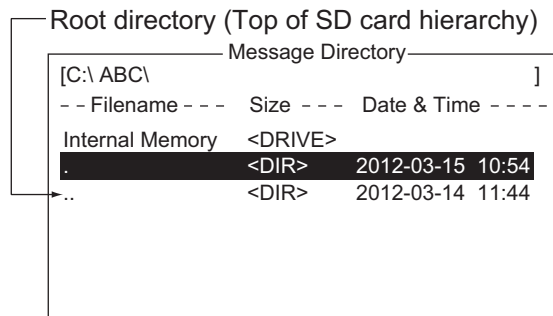

3. Press the ↓ key to put the cursor on “..” then press the **Enter** key.
4. Select a directory then press the **Enter** key.
5. Press the ↑ key to put the cursor on the top line ([A:]).
6. Press the **Esc** key to show the [Update] window.
7. [Yes] is selected; press the **Enter** key.
8. Long-press the **Esc** key to return to the standby display.

Note: The name of each message is automatically saved in the directory assigned, and the file name is with the year, month and day (YYYY:MM:DD) the message was received.

3.9.3 How to delete a directory

1. To delete a directory in an SD card, insert an SD card in the SD card slot.
2. Press the **F8** and **7** keys to open the [Directories] menu.
3. Select [Message Directory] then press the **Enter** key.
4. Select the directory to delete then press the **Del** key.
The message "Directory not empty. All files and directories in the directory will be deleted." is displayed. Confirm or cancel the deletion, as appropriate.
5. Long-press the **Esc** key to return to the standby display.

3.10 E-mail Service/SMS Station List

E-mail service providers and SMS stations are already registered in the FELCOM. To add new e-mail service provider or SMS stations, follow the procedure below.

1. Press the **F8**, **8** and **5** keys to show the [E-Mail/SMS Service List].

E-Mail/SMS Service List					
Ctrl+I: Initialize ENTER: List Entry ESC: Quit					
	LES Name	AOR.W	AOR.E	POR	IOR
01	Vizada (USA)	001	101	201	301
02	Stratos (NED)	012	112	212	312
03	Stratos Global	002	102	202	302
04	Vizada (NOR)	004	104	204	304
05	KDDI	003	103	203	303
06	Vizada (France)	021	121	221	321
07					

2. Select a blank line in the [LES Name] column then press the **Enter** key.

Service LES Name
Service ID (E-Mail)
(SMS)
LES ID (AORW)
(AORE)
(POR)
(IOR)
To:
Cc:
Subject:
Separator:
SMS:
Attach File (MIME) OFF

Enter data for LES which offers e-mail services.
For details, contact LES directly.

Example: Enter data of the Vizada to do SMS mail
or e-mail service:

Service LES Name	Vizada (NOR)
Service ID (e-mail)	28
Service ID (SMS)	66
LES ID (AORW)	004
AORE	104
POR	204
IOR	304
To:	TO:
Cc:	CC:
Subject:	SUBJECT:
Separator:	Blank
SMS:	Blank
Attach File (MIME)	ON(UUENCODE)

3. Press the **Enter** key to open the [Service LES Name] entry window.
4. Enter the name of the LES that provides the e-mail service then press the **Enter** key.
5. Select [Service ID (E-Mail)] then press the **Enter** key.
6. Enter the service ID then press the **Enter** key.
7. Select [Service ID (SMS)] then press the **Enter** key.
8. Enter the service ID then press the **Enter** key.
9. Select [LES ID (AORW)] then press the **Enter** key.
10. Enter the LES ID for AORW then press the **Enter** key.
11. Enter the LES IDs for AORE, POR and IOR.
12. Select [To:] then press the **Enter** key.
13. Type appropriate "To" header then press the **Enter** key.
14. Select [Cc:] then press the **Enter** key.
15. Type appropriate "Cc" then press the **Enter** key.
16. Select [Subject:] then press the **Enter** key.
17. Type appropriate "Subject" then press the **Enter** key.

3. SYSTEM INITIALIZATION

18. Select [Separator:] then press the **Enter** key.
19. Type appropriate "Separator" (for example, blank space, STX, etc.) then press the **Enter** key.
20. Select [SMS:] then press the **Enter** key.
21. If it is necessary to enter the special Prefix "sms+" before telephone number, type it here. For example, for Singapore Telecom, enter sms+8190123456789.
22. Select [Attach File (MIME)] then press the **Enter** key.
23. Select [ON(BASE64)], [ON(UUENCODE)] or [OFF] as appropriate then press the **Enter** key. **BASE64**: General text converter, **UUENCODE**: UNIX text converter.
24. Long-press the **Esc** key to return to the standby display.

How to restore the default E-mail/SMS service list

Press Ctrl+I. The message "Restore to default E-Mail/SMS Service List." appears. Select [Yes] then press the **Enter** key to restore the default E-Mail/SMS Service List.

3.11 E-mail Settings

Choose the LES where to forward e-mail. Also, you may need to register with an LES which provides e-mail services.

1. Press the **F8**, **6** and **Enter** keys to open the [E-Mail/SMS Service List].

	LES Name	AOR.W	AOR.E	POR	IOR
01	Vizada (USA)	001	101	201	301
02	Stratos (NED)	012	112	212	312
03	Stratos Global	002	102	202	302
04	Vizada (NOR)	004	104	204	304
05	KDDI	003	103	203	303
06	Vizada (France)	021	121	221	321
07					

2. Choose the LES where to send e-mail then press the **Enter** key.
3. Long-press the **Esc** key to return to the standby display.

3.12 How to Export, Import System Settings

You can export and import system settings to and from an SD card. This allows you backup system settings and import them into the FELCOM in the event of a problem.

3.12.1 How to export system settings

1. Set a formatted SD card to the SD card slot.
2. Press the **F8, 8** and **6** keys to show the [Export/Import] menu.
3. Select [Export] then press the **Enter** key.
4. Select the item to export then press the **Enter** key.

Sent Message: Export a maximum of 50 sent messages. The messages are saved to the SD card under the original file name.

Received Message: Export a maximum of 50 received messages. The messages are saved to the SD card under the original file name.

EGC Message: Export a maximum of 50 EGC messages. The messages are saved to the SD card under the original file name.

Station List: Export the [Station List].

LES List: Export the [LES List].

E-Mail/SMS Service List: Export the [E-mail/SMS Service List].

Test: Export a maximum of five each of PV test and diagnostic test.

Maintenance: Export a maximum of 5000 entries of the [Current Position Log].

Settings: Export the settings of SSAS, EGC, Network and Terminal Unit.

5. The message "OK to Export?" appears. [Yes] is selected; press the **Enter** key to export selected data.



3.12.2 How to import system settings

1. Insert a SD card that contains system settings in the card slot.
2. Press the **F8, 8** and **6** keys to show the [Export/Import] menu.
3. Select [Import] then press the **Enter** key.

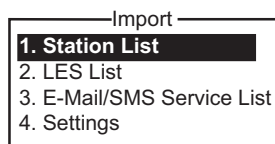

4. Select the item to import then press the **Enter** key.

Station List: Import the [Station List].

LES List: Import the [LES List].

E-Mail/SMS Service List: Import the [E-mail/SMS Service List].

Settings: Import settings (SSAS, EGC, Network and Terminal Unit).

5. The message "OK to Import?" appears. [Yes] is selected; press the **Enter** key to import selected data.

3. SYSTEM INITIALIZATION

This page is intentionally left blank.

4. FILE OPERATIONS

This chapter describes how prepare, edit, save and print files (messages).

4.1 Files and Working Areas

To create a new message it is necessary to open a new file. After a new file is opened, one of two working areas in the internal memory is secured to create the message. The term “open a file” also refers to the loading of a prepared file into a working area.

When you remove a file from a working area this is called “closing a file.”

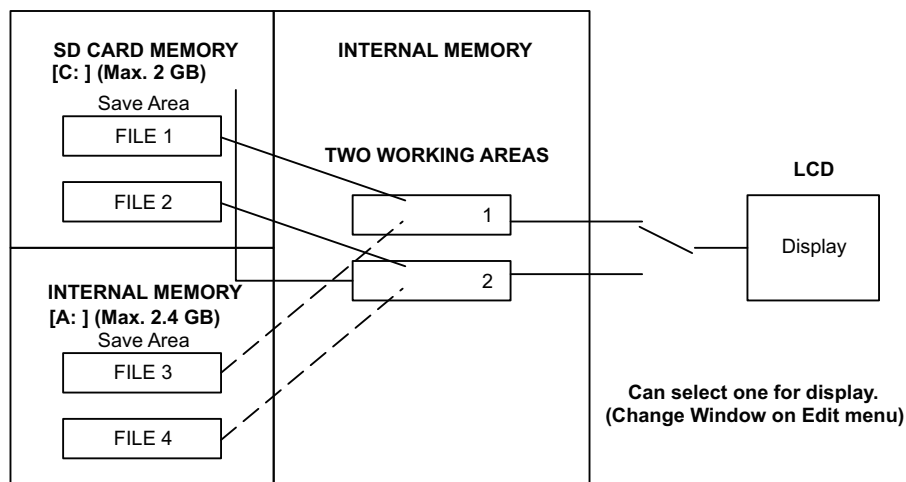

4.2 Preparing Files

There are two types of files: routine and confidential. Files can be assigned a file name and saved to an SD card or the internal memory, for later use. The maximum message size is 32 kilobytes.

4.2.1 How to prepare a routine file

1. Press the F1 key to open the [File] menu.

File	
1. New	ALT-N
2. Open	ALT-O
3. Close	ALT-Q
4. Save	ALT-S

5. Delete	ALT-D
6. Rename	

7. Print	ALT-P

8. Remove SD Card	

9. MIME (Decode)	

0. Format SD	

4. FILE OPERATIONS

2. Press the **1** key to select [New]. The display should now look something like the illustration below.

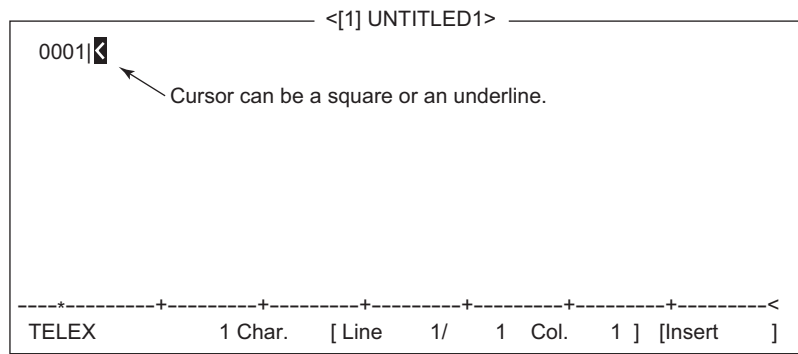

Note: When two working areas are opened and you try to open a third file, the message "Save this message" appears. When this occurs close an open file to free a working area.

3. The cursor is on the first line. Type your message.
4. To transmit the message you have just prepared, go to section 5.1.2. To save it to an SD card or the internal memory, for future transmission, go to section 4.3.2.

4.2.2 How to prepare a confidential file

If communicating with another FELCOM18, you can prepare a confidential message by entering "S???-addressee code(-password):" in the first line of message text. You can also receive confidential messages containing this header from a land subscriber or any MES which uses the FELCOM18.

There are two types of confidential messages: message with addressee code and message with both addressee code and password.

When the FELCOM receives a confidential message, the message is neither displayed nor printed immediately. To display or print the contents of a confidential message, the recipient executes the procedure shown in section 5.2.3.

Addressee code and password

Caller and recipient agree beforehand on both the addressee code and the password. The addressee code might be the title of the recipient; for example, CAPTAIN. The password could be the classification of the message; for example, SECRET.

How to prepare a message with addressee code

Type the addressee code as shown in the illustration below and then type the text of message.

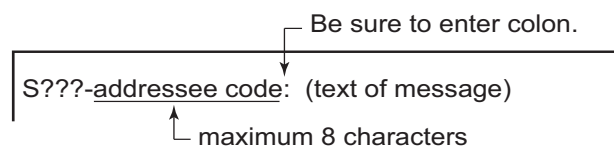

How to prepare a message with both addressee code and password

Type the addressee code as shown in the illustration below and then type the text of message.

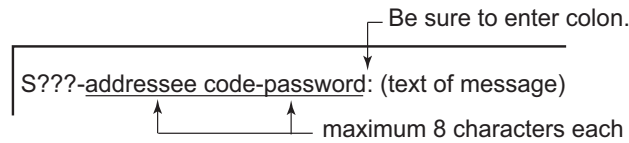

The recipient enters the password to view the contents of the message.

4.2.3 Editor menu settings

The Editor menu sets the parameters of the text editor.

1. Press the **F8** key to display the [Setup] menu then press the **2** key to show the [Editor Setup] menu.

Editor Setup	
Text Mode	Ascii
Edit Mode	Insert
Word Wrap	ON
Line No.	ON
Tab Width	4 Char
Column Width	69
Cursor Type	Block
Scroll	Full Screen

2. Set each item as required, referring to the descriptions below.

Text Mode: Select [Telex] to create a telex message. Only upper case alphabet is permitted in telex. Use [Ascii] to create an e-mail message. Upper and lower case alphabet may be used in an e-mail.

Edit Mode: Select [Insert] (insert character at cursor location) or [Overwrite] (write over character at cursor location).

Word Wrap: Turn automatic hyphenation at the end of a line on or off

Line No.: Turn the line number display on or off. See the illustration below.

Tab Width: Set the horizontal tab width, two, four or eight tabs per line.

Column Width: Set 69 for telex, 40 to 80 for ASCII.

Cursor Type: Select the cursor configuration, block or underline.

Scroll: Sets how much the screen moves up over the page ([Full Screen] or [Half Screen]) when the **Page Up** or **Page Down** key is operated.

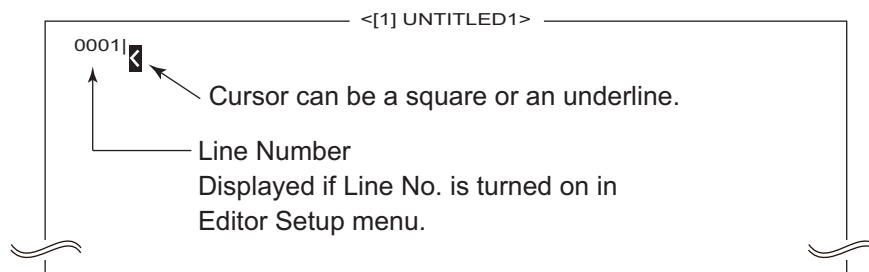

4.2.4 Text operations

How to cut and paste text

1. Use the arrow keys to place the cursor on the first character of the text to cut.
2. Highlight the text to be cut by pressing the → key while pressing and holding the **Shift** key. You can use the ← or → key to adjust the highlight. The figure below shows the appearance of highlighted text.

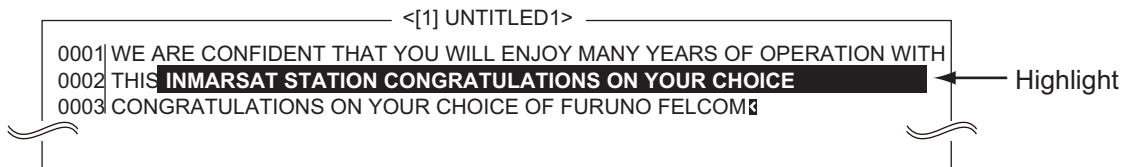

3. Press the **F2** key to open the [Edit] menu.
4. Press the **1** key to select [Cut]. The highlighted text is cut and the remaining text is reformatted. If you make a mistake, you can immediately restore the text by pressing the **Insert** key.
5. To move the text to a new location after it has been cut, place the cursor at the exact spot in the message where the cut text is to start. When the text cursor is placed correctly, press the **F2** key and then the **3** (Paste) key.

Edit	
1. Cut	DEL
2. Copy	ALT-C
3. Paste	INS
4. Insert (With Citation)	
5. Select All	ALT-A
6. Search or Replace	
7. Goto Line	
8. Time or Pos. Ins	
9. Change Window	ALT-V

How to copy and paste text

1. Select the text to copy.
2. Press the **F2** key to open the [Edit] menu.
3. Press the **2** key to select [Copy]. The selected text is copied to the clipboard.
4. Place the cursor at the exact spot on the message where the copied text is to start.
5. Press the **F2** key followed by the **3** key. The text is inserted at the cursor location.

Insert (with Citation)

When you reply to a received message, you can insert ">" in a received message at the head of the received message to distinguish it from your message.

1. Press the **F2** key to open the [Edit] menu.
2. Press the **4** key.
3. Select the file to use. (Use the **Spacebar** to view content of file. Press the **Esc** to close the file.)
4. Press the **Enter** key.

Select All

Select the entire current file for cut and copy:

1. Press the **F2** key to open the [Edit] menu.
2. Press the **5** key.

Search and replace**How to search text**

1. At the [Edit] menu, press the **6** key to select [Search or Replace].
2. Press the **1** key to select [1. Search].
3. [Search Word] is selected; press the **Enter** key to show the search word entry window.
4. Type the word to search then press the **Enter** key.
5. Select [Direction] then press the **Enter** key.
6. Select [Forward] or [Back] to select the direction to search from the cursor location then press the **Enter** key.
7. Press the **Esc** key to show the [Search Start] confirmation window.
8. [Yes] is selected; press the **Enter** key to start the search.
When the unit finds the word, the cursor stops at the first character of the word. If the string could not be found, the message "Not Found (To Quit: ESC)" appears. Press the **Esc** key to quit.
9. To continue the search, press the **Enter** key.

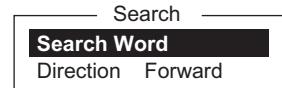
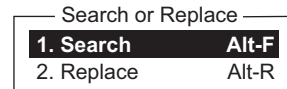
**How to replace text**

1. At the [Edit] menu, press the **6** key to select [Search or Replace].
2. Press the **2** key to select [2. Replace].
3. [Search Word] is selected; press the **Enter** key to show the search word entry window.
4. Type the word to search then press the **Enter** key.
5. Select [Replace Word] then press the **Enter** key.
6. Enter the replace word then press the **Enter** key.
7. Select [Direction] then press the **Enter** key.
8. Select the direction (forward or back) to search from the cursor location press the **Enter** key.
9. Select [Query or ALL] then press the **Enter** key.
10. Select [Query] or [ALL].
Query: Stop at each occurrence of word to answer yes or no to replacement.
ALL: Replace every occurrence of word without stopping to confirm.
11. Press the **Esc** key to show the [Replace Start] confirmation window.
12. [Yes] is selected; press the **Enter** key to start the replacement.
If you selected [ALL] at step 10, all occurrences of the search word are replaced with the replace word. If the string could not be found, the message "Not Found (To quit: ESC)" appears. Press the **Esc** key to quit.
If you selected [Query] at step 10, the message "Replace OK? (OK: ENTER Pass: SPACE To quit: ESC)" appears when the search word is found. Press the **Enter** key to replace the word, or hit the **Spacebar** to go to the next occurrence of the search word.

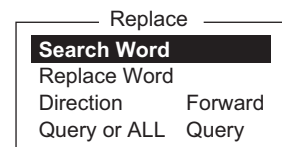

Go to line

Move the cursor to the desired line in the current file.

- **Top of text:** Go to top of text
- **End of text:** Go to end of text
- **Go to line:** Specify line number to go to.

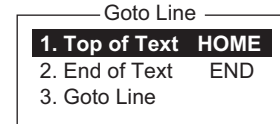

Press the **F2** and **7** keys. Place the cursor where desired then press the **Enter** key.

Time or Pos. Ins

Insert time or position in a sentence

1. At the [Edit] menu, press the **8** key to select [Time or Pos. Ins.]
2. Put the cursor where to insert the information then press the **1** key to insert time or the **2** key to insert position.

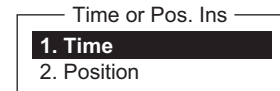

4.3 How to Save Files

4.3.1 How to handle SD cards (including SDHC cards)

After you have created a message you may wish to save it to an SD/SDHC card or the internal memory), for future use. (The internal memory stores up 2.4GB of TX files.)



Cards 2GB or less do not require formatting. Cards above that capacity must be formatted (on the Terminal Unit), and their capacity after formatting is 2GB. (A PC will also read them as being 2GB.) The following cards have been tested with the Terminal Unit:

- Panasonic RP-SDP 4, 8, 16, 32GB
- TOSHIBA SD-E 4, 8, 16, 32GB
- HAGIWARA HPC-SD/SDH 2,4GB
- BUFFALO RSDC-S 2, 8GB
- I-O DATA SD/SDH-V 2,16GB
- SanDisk SDSDB 4, 8, 16, 32GB

How to insert an SD card: Gently insert an SD card into its slot on the front panel of the terminal unit, connector side down and front. Handle the cards carefully to prevent damage, which could cause loss of data.

How to format an SD card: Insert the SD card into its slot. Press the **F1** and **0** keys. [Yes] is selected; press the **Enter** key to format the card.

How to eject an SD card: Press the **F1** and **8** keys. [Yes] is selected; press the **Enter** key then push the card to release it from the slot.

How to handle SD cards

- Do not remove a card from the slot until a card-related operation is completed, to prevent loss of data and damage to the card.

- You can prevent writing to the card. On the side that does not have the cutoff corner, there should be a white switch. Move the switch down to engage write protect.

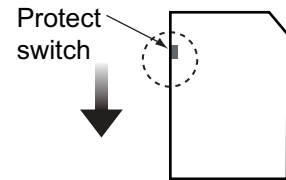

4.3.2 How to save files

You can save a message two ways: Save it without losing your place on the screen (called “save”), or save it before clearing the screen (called “close”).

Save file, retain place on screen

- Press the **F1** and **4** keys.

```

Save
[C:\ ]
-- Filename ---Size -- Date & Time ----
Internal Memory <DRIVE>
E0970715.001 372 11-12-25 02:52
E0970715.002 6794 11-12-25 02:59
E0970715.003 987 11-12-25 03:10
-----
3 Files exist 579584 bytes free
To View: SPACE Make Dir: INS Remove Dir: DEL

```

Note: The drive for an SD card is “C” and the drive for the internal memory is “A”.

- Enter a file name. You can not use brackets ([]), asterisk (*), comma (,), plus (+), (;) or equal sign (=).
- Press the **Enter** key to save the file and keep it on the screen.

Save file, clear screen

- Press the **F1** and **3** keys. The message "Save this message?" appears.
- [Yes] is selected; press the **Enter** key.
- Enter a file name at the cursor location.
- Press the **Enter** key to save the file and clear the screen.

4.4 How to Open Files

4.4.1 How to open a file

- If the file is on an SD card, insert it in its slot. Press the **F1** and **2** keys to show the list of files.

Note: The drive for an SD card is "C" and the drive for the internal memory is "A".

- Select a file. To get a partial view of a file, tap the **Spacebar**. Press the **Esc** key to escape.
- Press the **Enter** key.

A few moments later the contents of the file appear on the screen and the title bar shows the file name. You may repeat this procedure to load a second file into a working area.

4. FILE OPERATIONS

4.4.2 How to switch between files

You can switch between files by pressing the **9** key (Change Window) on the [Edit] menu ([F2]), or pressing **Alt+V** on the editor screen.

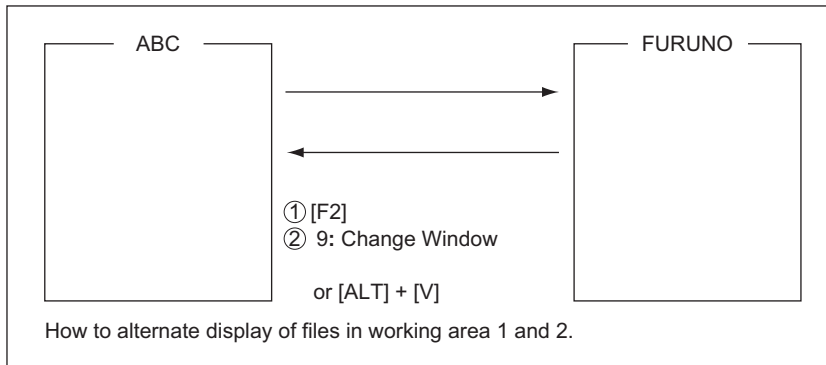

4.4.3 How to open a file when both working areas are occupied

If both working areas in the memory are occupied when you attempt to open a file, you are asked "Save this message?" for the active file.

1. To save the file, press the **Enter** key to show the [Save] window. If you don't need to save the file, select [No], press the **Enter** key then go to step 4.
2. To enter the same file name as the edited file, press the **Enter** key.
3. [Yes] is selected; press the **Enter** key.
4. Select the file to open then press the **Enter** key.

4.5 How to Save a File Under a New Name

1. Open a file referring to section 4.4.1.
2. Edit the file.
3. Press the **F1** key then the **3** (Close) or **4** (Save) key as applicable.
4. For [Close], press the **Enter** key.
5. Press the **BackSpace** key to delete the original file name. Enter a file name.
6. Press the **Enter** key.

Note: Should you decide to save the file under the original name, skip step 5. The message "File already exists. Overwrite?" appears. Overwrite the file by pressing the **Enter** key, or select [No] then press the **Enter** key to escape.

4.6 How to Print Files

You can print out a hard copy of files stored.

1. Press the **F1** and **7** keys to show the list of files. (If necessary, switch drives; C for SD card, A for the internal memory.)
2. Select a file. To get a partial view of a file, tap the **Spacebar**. Press the **Esc** key to escape.
3. Press the **Enter** key to print the file.

4.7 How to Combine Files

In the example procedure below, files A and B are combined.

1. Open file A.
2. Open file B.
3. Put the cursor at the beginning of the file B. While pressing and holding down the **Shift** key, press the ↓ key to highlight the entire file. (You can also select a portion of the file.)
4. Press the **C** key while holding down the **Alt** key to place file B on the clipboard.
5. Press the **V** key while holding down the **Alt** key to switch to file A.
6. Press the **Insert** key. File B is inserted at the top of the file A.

4.8 How to Delete Files

1. Press the **F1** and **5** keys to show a list of files. (If necessary you can switch drives. C drive (SD card) or A drive (internal memory).)
2. Select the file to delete. You can get a preview of a file by press the **Spacebar**. Press the **Esc** key to close the preview.
3. Press the **Enter** key. You are asked if it is OK to delete the file.
4. Press the **Enter** key to delete the file, or select [No] and press the **Enter** key to escape.

4.9 How to Change File Name

1. Press the **F1** and **6** keys to show a list of files. (If necessary you can switch drives. C drive (SD card) or A drive (internal memory).)
2. Select the file for which you want to change the name.
3. Press the **Enter** key.
4. Erase the file name then enter the new name.
5. Press the **Enter** key.

4.10 How to Decode an E-Mail Attachment

When you cannot read an e-mail attachment because it has been coded by MIME (Multipurpose Internet Mail Extensions), you may decode it as shown below.

1. Save the MIME-coded file to an SD card or the internal memory. (See section 5.2.5 for the procedure.) This step is not necessary if [Auto Receive Message Save] is turned on in the [Auto Mode Setup] menu.
2. Press the **F1** and **9** keys to select [MIME (Decode)]. A list of files stored on the SD card or internal memory appears.
3. Select the file to decode then press the **Enter** key.

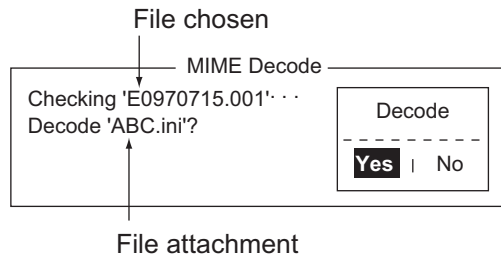

4. [Yes] is selected; press the **Enter** key to decode the file.

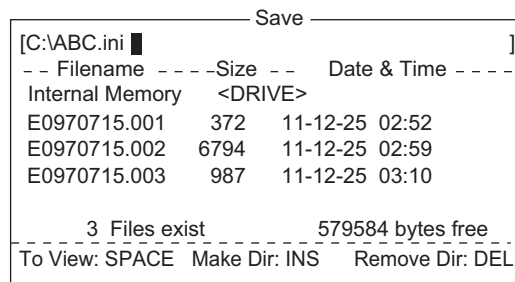

5. To change the file name, press the **BackSpace** key to erase the file name, enter a new file name then press the **Enter** key. After decoding the file the screen looks something like the one shown below.

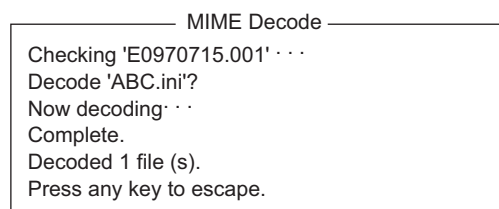

6. Long-press the **Esc** key to return to the standby display.
7. Press the **F1** and **2** keys.
8. Select the file selected at step 5 then press the **Enter** key.

5. INMARSAT COMMUNICATIONS

This chapter explains how to send and receive. Before conducting any communications, be sure to login with the NCS in your area, following the instructions in section 3.3.1.

To send e-mail, register for e-mail services with appropriate LES which provides such services. Further, it is necessary to register with appropriate LES to receive e-mail from land mail system. For further details, contact appropriate LES.

5.1 How to Send a Message

To send a message, create the message, attach the address of the recipient and then send it to the LES. The address of the recipient in the Inmarsat C system is his telex number, for transmission via landline, or MES Inmarsat Mobile Number (IMN), when sending to a ship.

The message can be one you have just prepared or one stored on an SD card or the internal memory. (Messages cannot be sent by direct keyboard input.)

5.1.1 Code description

Code can be specified at the terminal unit as follows:

IA5: International alphabet No. 5, ASCII code (7 bit). Specify this code to send English containing lower case alphabet.

ITA2: No. 2 international communications alphabet (5 bit). Specify this code for message which contains only No. 2 international communications alphabet (see the Appendix 4). ITA2 code is sent faster than IA5 code. Land-based telex equipment uses ITA2. The LES converts all codes into ITA2. Code which cannot be converted is shown with the question mark (?).

DATA: Data (8 bit). Use this code to send data.

Message	Subscriber	Destination type	Code	Remarks
English	Inmarsat C MES	Telex	IA5	
	Telex	Telex	ITA2	
	Fax	PSTN	IA5	Modem type "T30".
	E-mail	E-mail	IA5	
Russian	Inmarsat C MES	PSDN	DATA	
	Fax	Not available		
	E-mail	E-mail	DATA	
Japanese	Inmarsat C MES	PSDN	DATA	
	Telex	Not available		
	Fax	Not available		
	E-mail	E-mail	DATA	
Data	Inmarsat C MES	PSDN	DATA	
	Land Network	PSDN	DATA	

5.1.2 How to send a prepared message

This section explains how to send a message you have just prepared, via fax, telex, e-mail or SMS. For distress transmission, see Chapter 7. For 2-digit code services, see the table in section 5.1.6.

How to send a message to a station registered on the station list

1. Prepare message on the screen.
For e-mail or SMS, set [Text Mode] in the [Editor Setup] menu to [Ascii]. See section 4.2.3.
For e-mail attachment, prepare the attachment and save it to an SD card or the internal memory. SMS messages over 160 characters in length are sent in parts.
2. Press the **F3** key to display the [Transmit] menu.

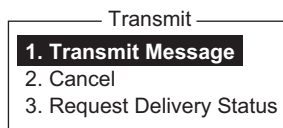

3. Press the **1** key to display the [Transmit Message] menu.

Transmit Message			
Priority	Normal		
Message File		Size	24
Station Name			
Destination Type	TELEX/MES		
Prefix Code			
Country/Ocean Code	82		
Destination	65-2111		
Modem Type			
Address			
Subject			
Attach File			
LES ID	303 (KDDI)		
Option	ON		
Confirmation	00:00		
Send Delay	Immediate		
Delivery Delay	IA5		
Code			
[TRANSMIT]			

4. Select [Station Name] then press the **Enter** key to open the Station List.

Station List			
Group	Station Name	Type	Code ID / Address
01	FURUNO	TELEX/	81 321
02	FRNINMBTSTS	TELEX/	583 343199999
03	Seagull	E-Mail	Seagull@furuno.co.jp
04	whale	E-Mail	whale@furuno.co.jp
05			
06			
07			
08			

↑ ↓: Select SPACE: Select Stations B.SPACE: Cancel Mark INS: Edit
Sort (Ctrl+G: Group, Ctrl+N: Station Name, Ctrl+T: Type)

5. Choose a station then press the **Enter** key. To select multiple stations* (simultaneous transmission), select a station and then press the **Spacebar**. Selected stations are marked with an asterisk (in case of Telex or FAX). For e-mail address, press the **Spacebar** to select "To," "Cc," Blank, "To" consecutively. * = Max. 10 telex stations, 7 FAX and 10 e-mail, and one SMS.

Note 1: Messages having different communication format or prefix code (two-digit code) cannot be sent simultaneously.

Note 2: To cancel selection (erase asterisk, To or Cc), select station and press the **BackSpace** key.

Note 3: You may sort the list by group name, station name or communication type as follows:

Group name: Each press of **Ctrl+G** sorts the list by group name, ascending or descending order.

Station name: Each press of **Ctrl+N** sorts the list by station name, in ascending or descending order.

Comm. type: Each press of **Ctrl+T** sorts the list by communication type, in ascending or descending order.

5. INMARSAT COMMUNICATIONS

6. For E-mail, follow the procedure below. For other communication formats, go to step 7.
 - 1) Select [Subject] then press the **Enter** key.
 - 2) Type subject then press the **Enter** key.
 - 3) To attach a file, select [Attach File] then press the **Enter** key.

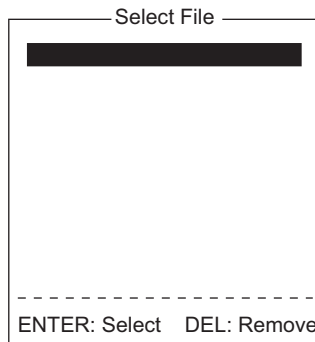

- 4) Press the **Enter** key to open the file list.
 - 5) Select a file then press the **Enter** key.
 - 6) Press the **Esc** key to close the window.
7. Select [LES ID] then press the **Enter** key to open the LES setting window. If the communication format is e-mail, the LES set in section 3.11 appears.

Name	LES ID	Remarks
Vizada 201	201	USA
Stratos Global	202	CANADA
KDDI	203	JAPAN
Vizada (NOR)	204	NORWAY
Korea Telecom	208	SOUTH KOREA

8. Select the LES to use then press the **Enter** key.
9. Select [Confirmation] then press the **Enter** key.
10. To request notification of delivery from the LES, select [ON]. If not necessary select [OFF]. Press the **Enter** key.
11. Select [Send Delay] then press the **Enter** key.
12. To send a message after a certain delay, enter a time up to 23 hours 59 minutes. (The [Send Delay] is used to time message arrival to suit recipient's office hours.) Press the **Enter** key.
13. Select [Delivery Delay] then press the **Enter** key.
14. [Delivery Delay] requests the LES for "Immediate" or "Deferred" transmission to the recipient designated. Select [Immediate] or [Deferred] then press the **Enter** key. For information on this service, consult with LES where message is to be sent.
15. Select [Code] then press the **Enter** key.
16. Select [IA5] (for e-mail, fax, SMS), [ITA2] (for telex) or [DATA] as appropriate then press the **Enter** key.
17. Put the cursor on [TRANSMIT] then press the **Enter** key to show the [Start] window.

18. Press the **Enter** key to send the message to the message queue. (To escape, select [No] then press the **Enter** key.) The message "Message is entered in sending Queue. Press any key." appears.

Note 1: If some data has not been entered, the message "Input Error: xx" (xx: error content) appears.

Note 2: When you send a message which contains more than 32 KB of data, the message "Message file is too large (but enable to send)."

Note 3: Messages sent to the message queue may contain up to 32 KB of data. If data is larger than 32 KB, the message "Can't enter this message to sending Queue. Press any key." appears.

19. Long-press the **Esc** key to return to the standby display.

The message(s) will be sent according to the [Send Delay] setting. "Current State: SENDING" appears at the bottom of the screen while the message is being sent. If the message was sent successfully, "Successful Sending message" appears and the TX message is printed (if [Confirmation] is OFF). You can view details about the message in the [Display Log] (see section 5.3).

```
Sent Message
DELIVERY CONFIRMATION OFF

Message File : 00FOX.TXT      Message Size : 277 characters
LES         : Stratos M.N.   Date         : 02-03-10
Priority    : Normal         Time          : 06:06 (UTC)
Destination : TELEX/MES (Prefixed) 00111222222222222222 (IA5)
```

Display log printout example (Confirmation OFF)

When [Confirmation] is ON and you receive a delivery status message, the message "Delivery Status received for (file name)." appears and the delivery status message is printed.

```
Sent Message
DELIVERY CONFIRMED

Message File : 00FOX.TXT      Message Size : 277 characters
LES         : Stratos M.N.   Date         : 02-03-10
Priority    : Normal         Time          : 06:06 (UTC)
Destination : TELEX/MES(Prefixed) 00111222222222222222 (IA5)
```

Display log printout example (Confirmation ON, message delivered)

```
Sent Message but not delivered
DELIVERY FAILURE: xxx

Message File : 00FOX.TXT      Message Size : 277 characters
LES         : Stratos M.N.   Date         : 02-03-10
Priority    : Normal         Time          : 06:06 (UTC)
Destination : TELEX/MES (Prefixed) 00111222222222222222 (IA5)
```

Display log printout example (Confirmation ON, message not delivered)

5. INMARSAT COMMUNICATIONS

Sent Message but not delivered
DELIVERY STATUS NOT RECEIVED (in case of timeout)

Message File	: 00FOX.TXT	Message Size	: 277 characters
LES	: Stratos M.N.	Date	: 02-03-10
Priority	: Normal	Time	: 06:06 (UTC)
Destination	: TELEX/MES (Prefixed) 00111222222222222222 (IA5)		

Display log printout example (Confirmation ON, delivery status not delivered)

Depending on traffic, it may take at least 15 minutes to receive confirmation.

Status of sent message

The terminal unit displays the status of messages you have sent as follows:

Message send failed. This appears if the message could not be sent because of technical reasons such as satellite malfunction, signal degradation, or no reply from the LES. Try to send the message again.

Message send rejected. This appears when the LES rejects the message because of non-technical reasons such as unpaid subscriber's fee.

Message send pending. This appears when the circuits at the LES are busy. Your message will be sent once a circuit becomes clear.

How to send a message to a station not registered on the station list

1. Prepare message on the screen.
For e-mail or SMS, set [Text Mode] in the [Editor Setup] menu to [Ascii]. See section 4.2.3.
For e-mail attachment, prepare the attachment and save it to an SD card or the internal memory. SMS messages over 160 characters in length are sent in parts.
2. Press the **F3** and **1** key to display the [Transmit Message] menu.

—Transmit Message—

Priority	Normal	Size	24
Message File			
Station Name			
Destination Type	TELEX/MES		
Prefix Code			
Country/Ocean Code	82		
Destination	65-2111		
Modem Type			
Address			
Subject			
Attach File			
LES ID	303 (KDDI)		
Option	ON		
Confirmation	00:00		
Send Delay	Immediate		
Delivery Delay	IA5		
Code			
[TRANSMIT]			

3. Select [Destination Type] then press the **Enter** key.

TELEX/MES	
FAX	
E-Mail	
SMS	
PSDN	
X400	
DNID	
Special	
TELEX/MES	(Prefixed)
FAX	(Prefixed)
PSDN	(Prefixed)
X400	(Prefixed)
DNID	(Prefixed)
Special	(Prefixed)

4. Select destination type then press the **Enter** key.
5. Continue the procedure according to the destination type.
 Telex/MES: page 5-7
 FAX: page 5-7
 E-mail: page 5-8
 SMS: page 5-8

Destination type: Telex/MES (prefixed)

1. Select [Country/Ocean Code] then press the **Enter** key.
2. For ship-to-shore telex, enter recipient's telex country code. For example, to use KDDI (Japan), enter 720. For ship-to-ship telex, enter recipient's ocean region: AOR-East, 581; POR, 582; IOR, 583, AOR-West, 584. Press the **Enter** key after entering number.
3. Select [Destination] then press the **Enter** key.
4. Type either recipient's telex subscriber number (ship-to-shore) or IMN (ship-to-ship) then press the **Enter** key.
5. Select [LES ID] then press the **Enter** key.

Name	LES ID	Remarks
Vizada 201	201	USA
Stratos Global	202	CANADA
KDDI	203	JAPAN
Vizada (NOR)	204	NORWAY
Korea Telecom	208	SOUTH KOREA

6. Select LES then press the **Enter** key.
7. Continue from step 9 on page 5-4.

Destination type: FAX

1. Select [Country/Ocean Code] then press the **Enter** key.
2. Enter country code of the recipient then press the **Enter** key.
3. Select [Destination] then press the **Enter** key.
4. Enter the FAX number of the recipient then press the **Enter** key.

5. INMARSAT COMMUNICATIONS

5. Select [Modem Type] then press the **Enter** key.

Modem Type		
T30	FAX	
V21	V.21	300bps Duplex
V22	V.22	1200bps Duplex
V22B	V.22bis	2400bps Duplex
V23	V.23	600/1200bps
V26B	V.26bis	2400/1200bps
V26T	V.26ter	2400bps Duplex
V27T	V.27ter	4800/2400bps
V32	V.32	9600bps Duplex
Other		

6. Select the modem type used by the recipient then press the **Enter** key. For transmission to landline fax or to fax-equipped Inmarsat B MES, select [T30]. (You cannot send a FAX to another Inmarsat C MES.)
7. Select [LES ID] then press the **Enter** key.
8. Select LES then press the **Enter** key.
9. Continue from step 9 on page 5-4.

Destination type: E-mail

1. Select [Address] then press the **Enter** key.
2. Type the e-mail address of the recipient then press the **Enter** key.
3. Select [Subject] then press the **Enter** key.
4. Type the subject of the e-mail then press the **Enter** key.
5. To attach a file, select [Attach File] then press the **Enter** key.
6. Press the **Enter** key to open the file list window.
7. Select a file then press the **Enter** key.
8. Press the **Esc** key to close the window.
9. Continue from step 9 on page 5-4.

Destination type: SMS

1. Select [Address] then press the **Enter** key.
2. Type the mobile phone number of the recipient then press the **Enter** key.
3. Select [LES ID] then press the **Enter** key.
4. Press the **Enter** key to close the window.
5. Continue from step 9 on page 5-4.

5.1.3 How to send a saved file

If the file is on an SD card, insert the card in the SD card slot.

1. Close any open files.
2. Press the **F3** and **1** keys to show the [Transmit Message] menu.

Transmit Message	
Priority	Normal
Message File	Size 24
Station Name	
Destination Type	TELEX/MES
Prefix Code	
Country/Ocean Code	82
Destination	65-2111
Modem Type	
Address	
Subject	
Attach File	
LES ID	303 (KDDI)
Option	ON
Confirmation	00:00
Send Delay	Immediate
Delivery Delay	IA5
Code	
[TRANSMIT]	

3. Select [Message File] then press the **Enter** key.

Send			
Filename	Size	Date & Time	
Internal Memory <DRIVE>			
IIT	9078	12-01-08	19:30
JJJ	13	12-01-28	20:57
R0970714.001	4973	12-01-29	05:56
R0970718.001	313	12-02-25	00:25
R0970729.001	412	12-02-25	07:21
SEIZOU	139	12-02-25	06:22
SEIZOU .TXT	39	12-02-25	21:22
70 Files exist		590848 bytes free	
To View: SPACE Make Dir: INS Remove Dir: DEL			

If necessary, switch the drive, type A: for internal memory or C: for SD card, on the drive name line.

4. Select a file then press the **Enter** key. (You can view a part of a file by tapping the **Spacebar**. After confirming the contents, press the **Esc** key.)
Note: When an e-mail with attachment is sent, the file volume increases by 1.5 times because of MIME coding. To lower the charges, select the file to attach from the [Message File] and select [DATA] from [Code].
5. To send the message to a station registered on the station list, follow from step 4 on page 5-3. To send to a station not listed on the station list, follow from step 3 on page 5-7.

5.1.4 How to cancel transmission on a message awaiting transmission

As noted earlier a TX message is held in the buffer, usually until it is sent satisfactorily. To cancel transmission on a message held in the buffer, do the following:

1. Press the **F3** and **2** keys to show the [Cancel] screen.

Cancel						
No.	Message File	Destination	LES	Priority	Send	Status
01	S11111.001	INET	Vizada 101	Normal	Sending	

Send status

Waiting: Waiting to send message

Sending: Now sending message

Fail: Failed transmission

Rejected: Message rejected by LES.

Pending: LES circuits occupied.

2. Select the message to cancel then press the **Enter** key. The [Cancel] prompt appears.
3. Press the **Enter** key to cancel the message, or select [No] and press the **Enter** key to escape.
4. Long-press the **Esc** key to return to the standby display.

5.1.5 How to request delivery status

Automatically receiving delivery status

You can automatically receive delivery status of messages you send to a LES, by selecting "Confirming ON" in the [Transmit Message] menu. Sent messages which request delivery status appear in the [Message Status List]. The [Message Status List] holds delivery status information for 30 messages. When the list is full, the oldest entry is deleted to make room for the latest.

1. Press the **F3** and **3** keys to show the [Request Delivery Status] list. If there are no messages in the list, "No message" appears.

Request Delivery Status							
No.	Message File	Destination	LES	Priority	Send	Status	Delivery
01	S121127.007	FURUNO	KDDI	Normal	Waiting		
02	S121127.006	FURUNO	KDDI	Normal	Sending		
03	S121127.005	ASDFASDF	KDDI	Normal	02-02-26	9:40	OCC(002)
04	S121126.004		KDDI	Normal	02-02-25	20:16	
05	S121125.003	ABCDEFGHIJKDDI		Normal	02-01-23	16:09	Complete
06	S121124.002		KDDI	Normal	02-01-22	9:48	EEE(001)
07	S121124.001		KDDI	Normal	02-01-20	12:34	

Request delivery status list description

Item	Description
No.	Message number
Message File	File name.
Station	Name of the remote party.
LES	The name of the LES that received the message.
Priority	Message priority, normal or distress.
Send Status	The transmission status from the MES (own ship) to the LES; waiting or sending, and date and time of transmission for messages sent.
Delivery*	<p>The delivery status from the LES to the recipient. Complete: Message sent successfully White space: Delivery status not yet received Reason for no delivery:</p> <p>OCC(002:) Delivery tried (twice), but recipient busy. ABS: Absent subscriber BK: Message aborted BMC: No end of message or end of transmission received DER: Out of order EOS: Element of Service not subscribed (e-mail) FMT: Format error IAB: Invalid answerback INC: Inconsistent request (e-mail) INF: Call the network information service INV: Invalid call ITD: Awaiting delivery LDE: Maximum message length exceeded LPE: Local procedure error NA: Access barred NC: Network congestion NCH: Subscriber's number has changed NP: Not obtainable NRC: Reverse charging acceptance not subscribed RIS: Recipient improperly specified (e-mail) RDI Redirected call RPE: Remote procedure error RSB: Retransmission still being attempted SENT: Message sent to LES. TMD: Maximum number of addresses exceeded UNK: Unknown status (for example when the Logical channel number is zero)</p>

* Some non-delivery codes are not used depending on LES.

How to manually request delivery status

You can manually request an LES for delivery status of a message you have sent within the past 24 hours.

1. Press the **F3** and **3** keys to show the [Request Delivery Status] list. If there are no messages in the list, "No message" appears.

Request Delivery Status						
No.	Message File	Station	LES	Priority	Send Status	Delivery
01	ABC	FURUNO	KDDI	Normal	11-11-25	16:10
02	edit msg.002	FURUNO	KDDI	Normal		

2. Select a file then press the **Enter** key.

Request Delivery Status						
No.	Message File	Station	LES	Priority	Send Status	Delivery
01	ABC	FURUNO	KDDI	Normal	11-11-25	16:10
02	edit msg.002	FURUNO	KDDI	Normal		

Start

Yes No

3. [Yes] is selected in the [Start] window; press the **Enter** key to request status. If request was successful the message "Successful Delivery Status Request." appears.
4. Long-press the **Esc** key to return to the standby display.

Several minutes later the message "Delivery status received for (file name)" appears on the display. The reply from the LES appears in the [Delivery] column of the [Request Delivery Status] list.

5.1.6 How to access the 2-digit code service

A range of special safety and general maritime services, known as the 2-digit code services, may be sent. The list below shows the 2-digit code services available.

1. Use the text editor to prepare a message requesting a 2-digit code service.
2. Press the **F3** and **1** keys to display the [Transmit Message] menu.

Transmit Message	
Priority	Normal
Message File	Size 24
Station Name	
Destination Type	TELEX/MES
Prefix Code	
Country/Ocean Code	82
Destination	65-2111
Modem Type	
Address	
Subject	
Attach File	
LES ID	303 (KDDI)
Option	ON
Confirmation	00:00
Send Delay	Immediate
Delivery Delay	IA5
Code	
[TRANSMIT]	

3. Select [Destination Type] then press the **Enter** key.
4. Select [Special] then press the **Enter** key.
5. Select [Destination] then press the **Enter** key.
6. Enter 2-digit code referring to the table below then press the **Enter** key.

Code	Content	Remarks
31	Maritime enquiries	Request information including service offerings.
32	Medical advice	Request medical advice.
33	Technical assistance	Address technical enquiries to appropriate personnel.
37	Time and charges requested at end of call	Desirable for mobile operator when sending traffic for a third party.
38	Medical assistance	Request medical assistance.
39	Maritime assistance	Request maritime search and rescue assistance
41	Meteorological report	Necessary for ease of addressing weather reports from ship to meteorological centers.
42	Navigational hazards and warnings	Make urgent navigational meteorological danger reports.
43	Ship position reports	Route messages to ship safety reporting systems.

7. Select [LES ID] then press the **Enter** key.
8. Select [LES ID] then press the **Enter** key.

5. INMARSAT COMMUNICATIONS

9. Select [TRANSMIT] then press the **Enter** key.
10. Press the **Enter** key to send the message.
Note: If some data is missing the message "Input error.xx" (xx: error) is displayed.
11. Long-press the **Esc** key to return to the standby display.

The message "Current State: SENDING" appears at the bottom of the screen during transmission. If the message was sent successfully "Successful Sending message" appears and the message is printed ([Confirmation] is turned ON). You can see the contents on the [Display Log].

At present, not all LESs are offering the 2-digit code services. Contact the LES Operations Coordinator directly for information.

Some 2-digit code services may be provided free of charge by LESs, while other services are available for a fee, in some cases at reduced rates. For information, contact the LES directly.

5.1.7 Sent message log

The [Sent Message] log stores all messages sent. You can view the contents of the log as shown below.

1. Press the **F6** and **1** keys to show the [Sent Message] log.
2. Select a file then press the **Enter** key to show file contents.

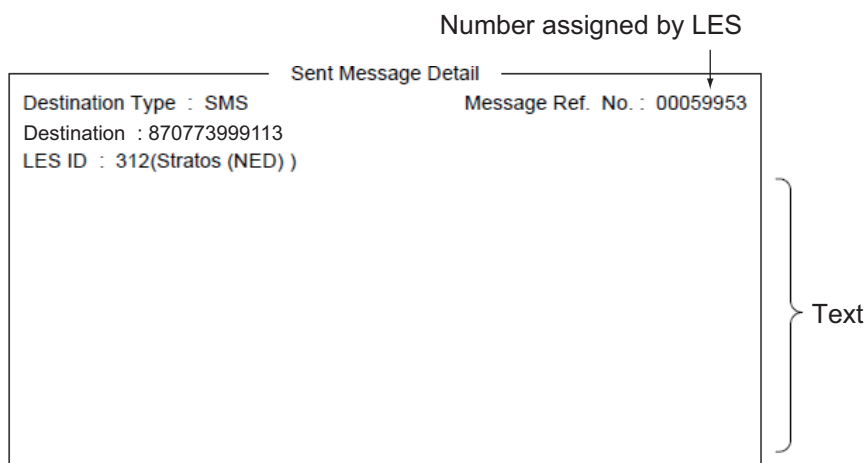

3. Long-press the **Esc** key to return to the standby display.

5.1.8 How to delete a sent message

1. Press the **F6** and **1** keys to display the [Received Message] log.
2. Select the file to delete. To confirm contents of a file, press the **Enter** key. For password-affixed messages the password entry window appears. Enter the password then press the **Enter** key.
3. Press the **Del** key to delete the file. You are asked if you are sure to delete the message file. For password-affixed messages, the password entry screen appears. Enter password then press the **Enter** key.
4. Press the **Enter** key to delete the message, or select [No] then press the **Enter** key to escape.
5. Long-press the **Esc** key to return to the standby display.

5.2 Receiving

5.2.1 When a message is received

When the FELCOM receives a telex or e-mail successfully it displays the message "Successful Receiving message." If [Auto Receive Message Save] and [Auto Receive Message Print] (in the [Auto Mode Setup] menu) are set for ON, the message is automatically saved and printed (except confidential and password-affixed messages).

Received message alarm

If [Receive Alarm] in the [Auto Mode Setup] menu is set for ON, the audio alarm sounds when a telex or e-mail is received. You may silence the alarm with the **F10** key.

Receive message format

Each message received is assigned a message number. This number is also used when saving the file to an SD card.

<u>R</u>	<u>0</u>	<u>1 1</u>	<u>1 2</u>	<u>2 5.</u>	<u>0 0 1</u>
Receive	0: main DTE 1: ext. DTE	year	month	day	received message no.

Log

The [Communication Log] (see section 5.3) shows message number, priority, date and time of reception, LES ID and file size (in bytes) of the latest 50 received and sent messages.

Printing

When [Auto Receive Message Print] in the [Auto Mode Setup] menu is set for ON, received messages (except confidential and password-affixed messages) are automatically printed. Manual printing is also available.

Saving and filing

Received messages are filed in the [Received Message] list, at the terminal unit specified with [Message Output Port] on the [System Setup] menu. The [Received Message] list shows the following:

- Received message no.
- LES ID
- Priority
- File size (in bytes)
- Message classification
- Password for confidential messages
- Date and time of reception
- Status

5.2.2 How to set the receive alarm

You can get an audio alarm when a telex message or e-mail is received. The default setting is OFF.

1. Press the **F8** and **5** keys to show the [Auto Mode Setup] menu.
2. Select [Receive Alarm] then press the **Enter** key.
3. Select [ON] to get the audio alarm when a telex message or e-mail is received then press the **Enter** key.
4. Long-press the **Esc** key to return to the standby display.

Auto Mode Setup	
Auto Communication Log Print	OFF
Receive Alarm	OFF
Auto Receive Message Save	OFF
Auto Receive Message Print	OFF
Data Report & Polling Print	OFF
Auto EGC Message Save	
Auto EGC Message Print	

5.2.3 How to display and print received messages

Received messages (except confidential or password affixed) are automatically printed when [Auto Receive Message Print] in the [Auto Mode Setup] menu is turned on. To print confidential or password-affixed messages follow the procedure below.

If you cannot read an e-mail attachment, because it is MIME-coded, go to section 4.10.

1. Press the **F6** and **2** keys to display the [Received Message] log.

Received Message						
Message No.	LES	Priority	Size	Addressee	Rec date & time	Status
R0971106.001	KDDI	Normal	32767		02-02-04 16:10	Saved
R0971105.002	KDDI	Normal	200	CAPTAIN	02-02-05 17:30	Printed
R0971105.001	KDDI	Distress	1234		02-02-05 14:15	Printed
R0971101.001	KDDI	Normal	3256	OFFICER	02-02-01 3:45	Printed
R0971024.001	KDDI	Normal	8251		02-01-24 13:20	Saved
Memory Available: 3317 Bytes						
[ENTER]: Show Detail						
[Ctrl]+[E]: Export [Ctrl]+[P]: Print [Delete]: Delete						

Contents of Received Message Log

Item	Description	Item	Description
Message No.	Received message no.	Addressee	Addressee code appears for confidential messages. Nothing appears for routine message.
LES	LES name	Rec date & Time	Date and time message was received.
Priority	Normal or Distress	Status	Printed, message printed; Saved, message saved to SD card or internal memory, No display, not yet printed confidential message or printer error
Size	Size of file in bytes	Memory available	Memory available in terminal unit

- Press the **Enter** key for routine messages and messages with addressee code (no password).



For messages with both addressee code and password, the password entry window appears. Enter the password and then press the **Enter** key. If the password is entered incorrectly, the buzzer sounds. Reenter the password.

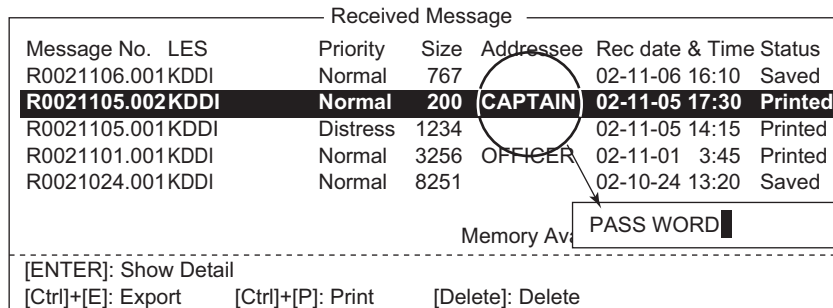

- To print a message, press the **P** key while pressing the **Ctrl** key.

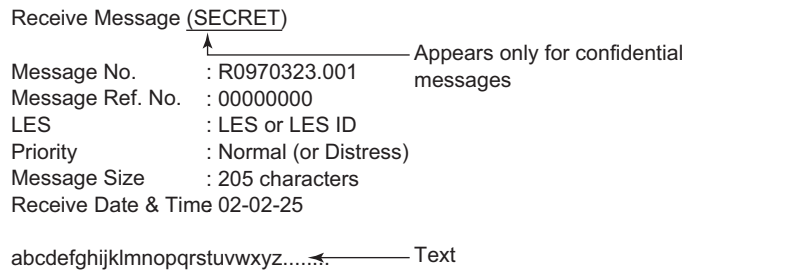

- Long-press the **Esc** key to return to the standby display.

About attachments

The FELCOM receives a file with an attachment over a landline two ways. (The method depends on LES.)

- Mail main text and text mail which includes information about the attachment.
- Attachment data

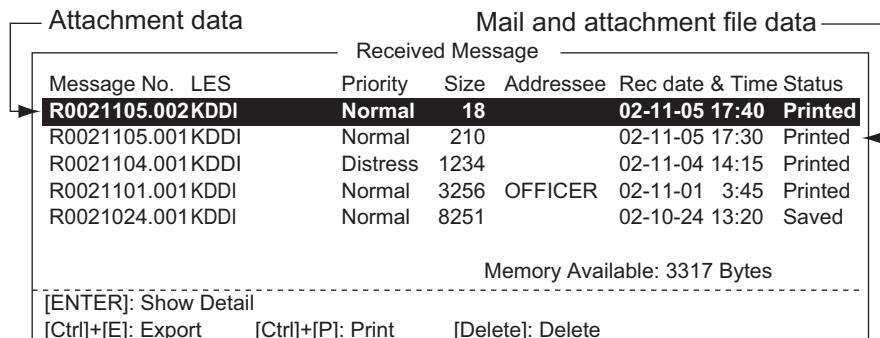

5. INMARSAT COMMUNICATIONS

Some files stored on the [Received Message] log may not be readable. Choose the file then press the **Enter** key. If the file is unreadable, because it is in a language other than English, press the **Esc** key to return to the [Received Message] log. Save the file to an SD card by pressing the **E** key while pressing and holding down the **Ctrl** key. Try to open the file from a PC.

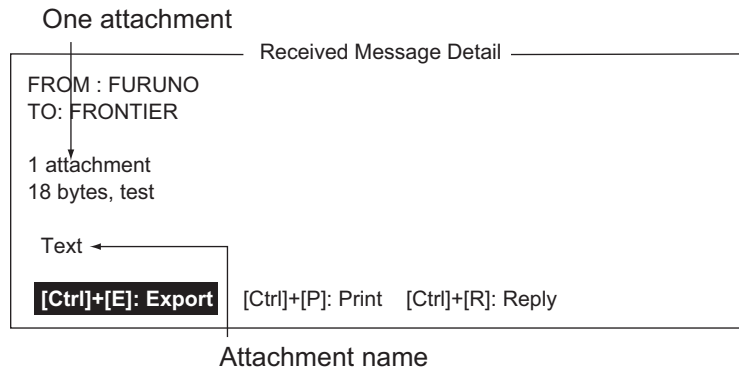

Example of text mail with text message and attachment

5.2.4 How to automatically print received messages

You can automatically print received messages (except confidential and password-af-fixed messages).

1. Press the **F8** and **5** keys to show the [Auto Mode Setup] menu.
2. Select [Auto Receive Message Print] then press the **Enter** key.
3. Select [ON] to automatically print received messages then press the **Enter** key.
4. Long-press the **Esc** key to return to the standby display.

5.2.5 How to save received messages

1. Press the **F6** and **2** keys to display the [Received Message] log.
2. Select the file to save. To confirm contents of a file, press the **Enter** key. For confidential messages the password entry window appears after pressing the **Enter** key. Enter the password then press the **Enter** key.
3. Press the **E** key while pressing and holding down the **Ctrl** key to save the file to the SD card or the internal memory. For confidential messages the password entry window appears. Enter password then press the **Enter** key.

If the same file name is found on the SD card (internal memory), "Already exists on the folder." appears.

5.2.6 How to automatically save received messages

1. Press the **F8** and **5** keys to show the [Auto Mode Setup] menu.
2. Select [Auto Receive Message Save] then press the **Enter** key.
3. Select [ON] to automatically save received messages then press the **Enter** key.
4. Long-press the **Esc** key to return to the standby display.

5.2.7 How to delete received messages

1. Press the **F6** and **2** keys to display the [Received Message] log.
2. Select the file to delete. To confirm contents of a file, press the **Enter** key. For password-affixed messages the password entry window appears. Enter the password then press the **Enter** key.
3. Press the **Del** key to delete the file. You are asked if you are sure to delete the message file. For password-affixed messages, the password entry screen appears. Enter password then press the **Enter** key.
4. Press the **Enter** key to delete the message, or select [No] then press the **Enter** key to escape.
5. Long-press the **Esc** key to return to the standby display.

5.3 Communication Log

The Communication Log stores the particulars of the latest 50 received and sent messages. When the log becomes full, the oldest message is automatically deleted.

5.3.1 How to display and print the communication log

1. Press the **F6** and **4** keys to display the [Communication Log].

Communication Log											
No.	S/R	Cate	Type	Ch	Ch-Num	Pri	LES	Size	St	Op. Time	Date & Time
001	S	MSG	TLX	MSG	11100	Dis	322	10	S	0031104000	Dec-25-2011 17:46
002	R	POLL	DND	TDM	11200		322	10		0031104061	Dec-25-2011 17:44
003	S	DR	DND	SIG	11300		322	10	S	0031104122	Dec-25-2011 17:43
004											
005											
006											
007											
008											
009											
010											
[Ctrl]+[P]: Print											

2. To scroll the log, use the ↓ key.
3. To print the log, press the **P** key while pressing and holding down the **Ctrl** key.

Communication Log description

No:	Log no.
S/R:	S: Sent message, R: Received message
Cate:	Category (MSG, EGC, DR, EDR, PADR, EPADR, POLL)
Type:	Message type (Telex, e-mail, etc.)
Ch:	Channel type (TDM, SIG, etc.)
Ch-Num:	5-digit channel number
Pri:	Priority, Normal or Distress
LES	ID of LES that handled the message
Size:	Size of message (in Byte)
St:	Communication results. S, Success; F, Failed
Op. Time:	Total operating time (in sec) since commissioning
Date & Time:	Date and time the message was sent.

Note: The [Communication Log] is not deletable.

5.3.2 How to automatically print the communication log

1. Press the **F8** and **5** keys to show the [Auto Mode Setup] menu.
2. Select [Auto Communication Log Print] then press the **Enter** key.
3. Select [ON] to automatically print the log then press the **Enter** key.
4. Long-press the **Esc** key to return to the standby display.

5.4 EGC Messages

When an EGC message is received, "RECEIVING EGC MESSAGE" appears at the bottom left corner of the display. If "Auto EGC Message Print" in the [Auto Mode Setup] menu is ON, EGC messages are automatically printed. EGC messages are automatically received, printed and saved to the terminal unit selected with [EGC Output Port] on the [System Setup] menu. The memory capacity for EGC messages is 32 Kbytes. When the EGC message memory becomes full, the oldest EGC message is automatically deleted.

EGC messages can be automatically saved to an SD card or the internal memory. See section 3.4.4 for details.

5.4.1 How to display and reprint EGC messages

1. Press the **F4** and **1** keys to show the [Display EGC Message] screen.

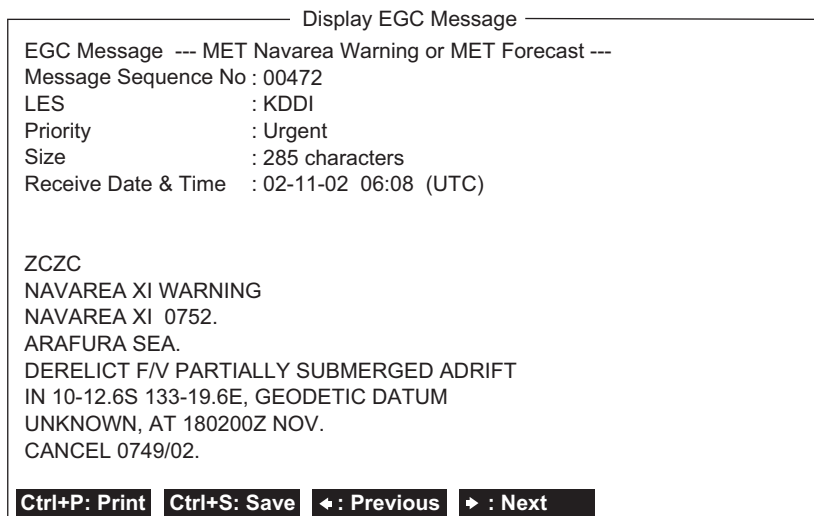

2. Use the **↑** and **↓** keys to scroll the screen.
3. To print a message, press the **P** key while pressing and holding down the **Ctrl** key.
4. Long-press the **Esc** key to return to the standby display.

EGC messages can be automatically saved to an SD card. See section 3.4.4 for details.

5.4.2 How to display EGC closed network ID (ENID)

To join a FleetNET service, an MES must be registered with an information provider. The information provider adds the MES to the group which is to receive the service, by downloading a Group Call ID (via an LES which supports FleetNET broadcasts), uniquely addressed to the MES. The MES stores the ID and can accept broadcasts from the information provider. The MES operator cannot change this stored EGC closed network IDs (ENIDs). Up to 64 ENIDs are stored on a non-volatile memory.

The ENID stored can be accessed for downloading and deleting via the satellite path. An MES operator can inhibit (or activate as required), via the terminal unit, selected ENIDs previously downloaded.

Along with the ENID the name of the information provider is stored. In the event that a download command is received and the ENID storage area is full, an ENID which has been disabled by the MES operator will be written over. If none has been disabled, then the new download is not accepted.

Follow the procedure below to inhibit or activate an ENID.

1. Press the **F4** and **2** keys to show the [EGC Network ID] screen.

```

      EGC Network ID List
      Ctrl+P: Print
      Mark ** means activation.
      -----
      01 * 11111
      02 * 22222
      03 * 33333
      04 * 44444
      05 * 55555
  
```

2. Select the ENID to enable or disable.
3. Press the **Enter** key to enable or disable the ENID as appropriate. The asterisk disappears when an ENID is disabled.
4. Long-press the **Esc** key to return to the standby display.

5.4.3 How to receive EGC distress or urgent message

When the FELCOM receives an EGC distress or an urgent message, the audio alarm sounds from its terminal unit, the Distress Alert/Received Call Unit IC-305 and Alarm Unit IC-350. To silence the alarm, do the following:

FELCOM18: **F10** (StopAlarm) key on the terminal unit
 IC-350: **MUTE ALARM** button

5.4.4 How to display the EGC message log

1. Press the **F6** and **3** keys to show the [EGC Message] log.

EGC Message						
Message No.	LES	Priority	Size	Seq. No.	Rec date&time	Type
E0021118.028	KDDI	Urgent	428	01641	11-11-25 10:27	MET/NAV
E0021118.028	KDDI	Safety	428	02035	11-11-11 05:21	U.M Rct
Memory available: 32767 Bytes						

[ENTER]: Show Detail						
[Ctrl]+[E]: Export		[Ctrl]+[P]: Print		[Delete]: Delete		

Scroll: ↑, ↓

Display message: Press the **Enter** key.

Save message: Press the **E** key while pressing and holding down the **Ctrl** key.

Delete message: Press the **Delete** key to show the Delete window. [Yes] is selected; press the **Enter** key.

2. Long-press the **Esc** key to return to the standby display.

5.4.5 How to delete EGC messages

1. Press the **F6** and **3** keys to display the [EGC Message] log.
2. Select the file to delete. To confirm contents of a file, press the **Enter** key. For password-affixed messages the password entry window appears. Enter the password then press the **Enter** key.
3. Press the **Del** key to delete the file. You are asked if you are sure to delete the message file. For password-affixed messages, the password entry screen appears. Enter password then press the **Enter** key.
4. Press the **Enter** key to delete the message, or select [No] then press the **Enter** key to escape.
5. Long-press the **Esc** key to return to the standby display.

6. DATA REPORT AND POLLING

This chapter provides the information necessary for data reporting and polling reception. Data reporting provides automatic data transmission at regular intervals from your ship to your home office. When your ship receives a polling command from your home office; that is, a request for navigation data from your ship, it automatically transmits this data to your home office.

No operator intervention is required during polling reception.

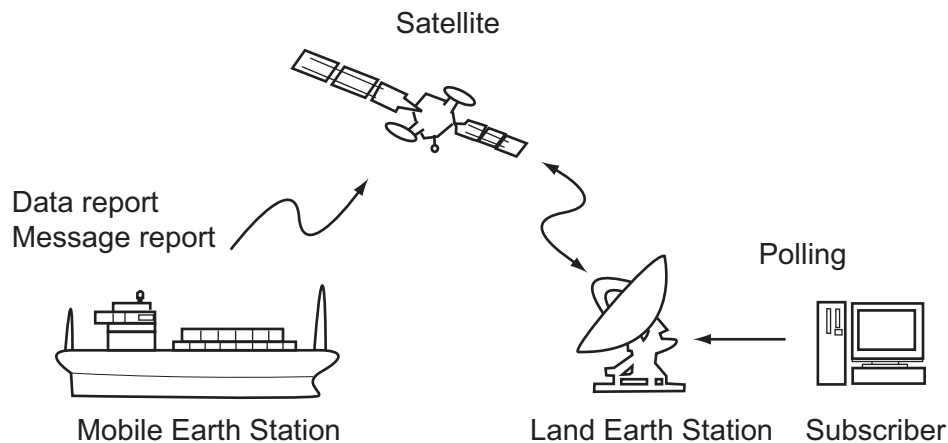

6.1 Data Reporting

Data reporting provides automatic data transmission at predetermined intervals from your ship to your home office. The data are position, speed, bearing and other data sent from a navigator or an interface unit.

The data transmitted from the FELCOM is temporarily stored in a data reporting file at the LES. When an operator at your home office accesses the LES, the LES delivers the data to your home office. Some LESs may deliver it without being accessed.

Data reporting can be initiated by setting a data report on the FELCOM or receiving a polling command from your home office.

This FELCOM offers two types of reports:

- Data report (on MES signaling channel). See section 6.1.1.
- Message report (on MES message channel). See section 6.1.2.

6.1.1 How to prepare a data report

1. Press the **F5** and **1** keys to show the [Data Report] menu.
2. Press the appropriate numeric key to select a data report.

Data Report

1. Data Report 1

2. Data Report 2

3. Data Report 3

4. Data Report 4

Data Report

Data Report Programming

Status OFF

Report Length Position and Course/Speed

Destination

DNID

LES ID

Member No.

Activation Regular Interval

Interval Time 00:10

Report Times 1 (---: No Limit)

Start Time1 --:--

Start Time2 --:--

Start Time3 --:--

Start Time4 --:--

3. [Status] is selected; press the **Enter** key to open the status options window.
4. Select appropriate option then press the **Enter** key.
 - OFF:** Data report off
 - ON: Enhanced Data Report** (Data report w/confirmation)
 - ON: Usual Data Report** (Standard data report)
 - For assured transmission, select [ON: Enhanced Data Report].
5. Select [Report Length] then press the **Enter** key.
6. Select appropriate option then press the **Enter** key.
 - Position only:** Own position
 - Position and Course/Speed:** Position, course and speed
 - Position and Course/Speed with SEA INF:** Position, course, speed, water temperature, tide, and depth
7. Select [Destination] then press the **Enter** key.
8. Select DNID desired then press the **Enter** key. (LES ID and Member No. are automatically selected according to DNID.)
9. Select [Activation] then press the **Enter** key.
10. Select [Regular Interval] or [Daily] as appropriate then press the **Enter** key.
11. Do one of the following depending on selection made at step 10.
 - [Regular Interval] selected at step 10
 - 1) Select [Interval Time] then press the **Enter** key.
 - 2) Key in interval time then press the **Enter** key.
 - 3) Select [Report Times] then press the **Enter** key.
 - 4) Key in the report times, or press the **BackSpace** key to display "---" to select [No Limit] to transmit data until the Status setting is turned OFF. Press the **Enter** key.
 - 5) Press the **Enter** key to close the window.
 - [Daily] selected at step 10
 - 1) Select [Start Time 1] then press the **Enter** key.
 - 2) Key in the start time, in 24-hour notation, then press the **Enter** key.
 - 3) If necessary, key in the start times 2-4.
12. Press the **Esc** key to show the [Update] window.

13. [Yes] is selected; press the **Enter** key to register the settings.
14. Long-press the **Esc** key to return to the standby display.

6.1.2 How to prepare a message report

1. Press the **F5** and **2** keys to show the [Message Report] menu.
2. Press the appropriate numeric key to select a message report.

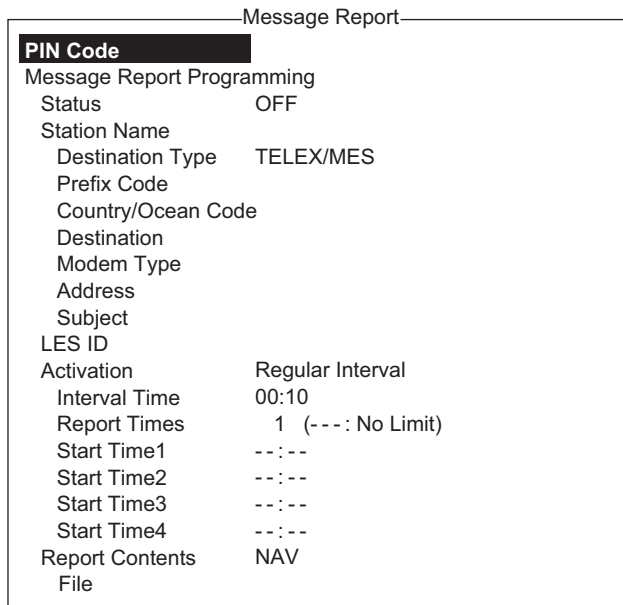
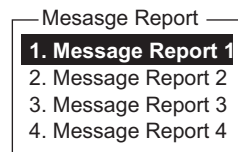

PIN code is unrelated to message reporting, however it is necessary for polling (see section 6.2). Enter PIN code as shown below.

3. [PIN Code] is selected; press the **Enter** key to open the PIN code entry window.
4. Key in PIN code, using up to eight digits, then press the **Enter** key. The PIN code is a password used in message reports. When a ship receives a polling command w/PIN code from a shore subscriber and the code matches that of the ship, the ship sends a message report.
5. Select [Status] then press the **Enter** key.
6. Turn the message report ON or OFF as appropriate then press the **Enter** key.
7. Select [Station Name] then press the **Enter** key.
8. Select the station name then press the **Enter** key.
You may sort the list by group name, station name or communication type as follows:
 - Group name:** Each press of **Ctrl+G** sorts the list by group name, ascending or descending order.
 - Station name:** Each press of **Ctrl+N** sorts the list by station name, in ascending or descending order.
 - Comm. type:** Each press of **Ctrl+T** sorts the list by communication type, in ascending or descending order.
9. For e-mail do step 1) and 2) below. For other communication formats, go to step 10.
 - 1) Select [Subject] then press the **Enter** key.

6. DATA REPORT AND POLLING

- 2) Key in the subject then press the **Enter** key.
10. Select [LES ID] then press the **Enter** key.
11. Select LES then press the **Enter** key.
12. Select [Activation] then press the **Enter** key.
13. Select [Regular Interval] or [Daily] as appropriate then press the **Enter** key.
14. Do one of the following depending on selection made at step 13.
[Regular Interval] selected at step 13
 - 1) Select [Interval Time] then press the **Enter** key.
 - 2) Key in interval time then press the **Enter** key.
 - 3) Select [Report Times] then press the **Enter** key.
 - 4) Key in the report times, or press the **BackSpace** key to display "---" to select [No Limit] to transmit data until the Status setting is turned OFF. Press the **Enter** key.[Daily] selected at step 13
 - 1) Select [Start Time 1] then press the **Enter** key.
 - 2) Key in the start time, in 24-hour notation, then press the **Enter** key.
 - 3) If necessary, key in the start times 2-4.
15. Select [Report Contents] then press the **Enter** key.
16. Select required report contents then press the **Enter** key.
NAV: Position, speed, course
NAV+SEA INF: Position, speed, course, water temperature, current, depth
NAV(R): Position, speed, course. The difference between this and [NAV] above is that blank areas in data are shortened to lessen toll charge.
FILE: Select a file. When selected [FILE] is activated, select the file then press the **Enter** key.)
17. Press the **Esc** key to show the [Update] window.
18. [Yes] is selected; press the **Enter** key.
19. Long-press the **Esc** key to return to the standby display.

6.1.3 How to automatically print data report, polling command

1. Press the **F8** and **5** keys to show the [Auto Mode Setup] menu.
2. Select [Data Report & Polling Print] then press the **Enter** key.
3. Select [ON] to automatically print data reports and polling commands then press the **Enter** key.
4. Long-press the **Esc** key to return to the standby display.

Auto Mode Setup	
Auto Communication Log Print	OFF
Receive Alarm	OFF
Auto Receive Message Save	OFF
Auto Receive Message Print	OFF
Data Report & Polling Print	OFF
Auto EGC Message Save	
Auto EGC Message Print	

6.2 Polling

When the FELCOM receives a polling command from your home office it automatically transmits data to your home office. The data are position, speed, bearing and other data sent from a navigator or an interface unit.

A polling command from your home office can also activate a data report or message report if the corresponding setting is completed on the FELCOM. If a polling command with a file name is received, the FELCOM transmits the file to your home office.

6.2.1 Polling commands

This section shows you how to make the polling command at your home office.

There are two kinds of polling commands: one is sent on the MES signaling channel and the other is sent on the MES message channel.

Polling command on the MES signaling channel

When a polling command is received from your home office, your vessel's coordinates (position), bearing and speed can be sent automatically as a data report.

The available polling commands are:

- Send a report to the ship once only
- Send a report to the ship at regular intervals
(A program cycle report dependent on the polling command)

Note: The polling command differs according to land earth station. Contact the land earth station directly for details.

Polling command on the MES message channel

To make the polling command, enter D???, hyphen, PIN code (max. 8 digits), hyphen, file name, colon.

To send file data, type a hyphen and file name. Then, only the file specified in the directory of the Message Directory is transmitted. If neither hyphen nor file name is entered, nav data (own ship position, course, speed, etc.) is transmitted.

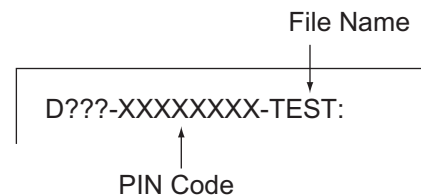

How to register your PIN code

The PIN (Personal ID Number) code is a password used in message reporting, and is an eight-digit number agreed upon by communicating parties. There is no rule for determining PIN code. When a ship receives a polling command w/PIN code from a shore subscriber and the code matches that of the ship, the ship sends a message report.

1. Press the **F5** and **2** keys to show the [Message Report] menu.

6. DATA REPORT AND POLLING

2. Press the **1**, **2**, **3** or **4** key to select a message report and show the following menu.



3. [PIN Code] is selected; press the **Enter** key to open the PIN code entry window.
4. Enter PIN code number (max. 8 digits) then press the **Enter** key.
5. Follow the procedure from step 5 on page 6-3.

6.2.2 Other polling commands

Telex: P???:/PIN Code/TELEX/LES number/Country number/Subscriber's number/File name:

E-mail: P???:/PIN Code/EMAIL/LES number/ E-mail address/File name:

Public Switched Telephone Network: P???:/PIN Code/PSTN/Modem type/LES number/Country number/Subscriber's number/File name:

Modem type is selected from T30, V21, V22B, V22, V23, V26B, V26T, V27T or V32.

Packet Switched Data Network: P???:/PIN Code/PSDN/LES number/Country number/Subscriber's number/File name:

Data Network Identification: P???:/PIN Code/DNID/LES number/Subscriber's number/File name:

Facsimile: P???:/PIN Code/FAX/LES number/Country number/Subscriber's number/File name:

2-digit telex service: P???:/PIN Code/SPEC/LES number/Country number/Subscriber's number/File name:

For ship-to-ship communication, country number is ocean region number. Subscriber's number includes Station ID, Telex ID, etc. If file name is not specified (/:), position, speed, bearing, water temperature, current and depth are transmitted. Furthermore, / is deleted (:), position, speed and bearing are transmitted.

For example, you transmit polling command to MES of PIN code 12345678 via KDDI station (Pacific Ocean: 203) specifying telex number 720-5644325. Then, that MES transmits position, speed, bearing, water temperature, current and depth.

P???:/12345678/TELEX/203/720/5644325/:

To have other MES transmit position, speed and bearing by e-mail to abc@furuno.co.jp, for example, use the following command.

P???:/12345678/EMAIL/203/abc@furuno.co.jp:

6.2.3 Polling reception

No operator intervention is required during polling reception.

The printer (PP-510 or PP-520) prints the status of polling reception and transmits data in response to polling request as shown below.

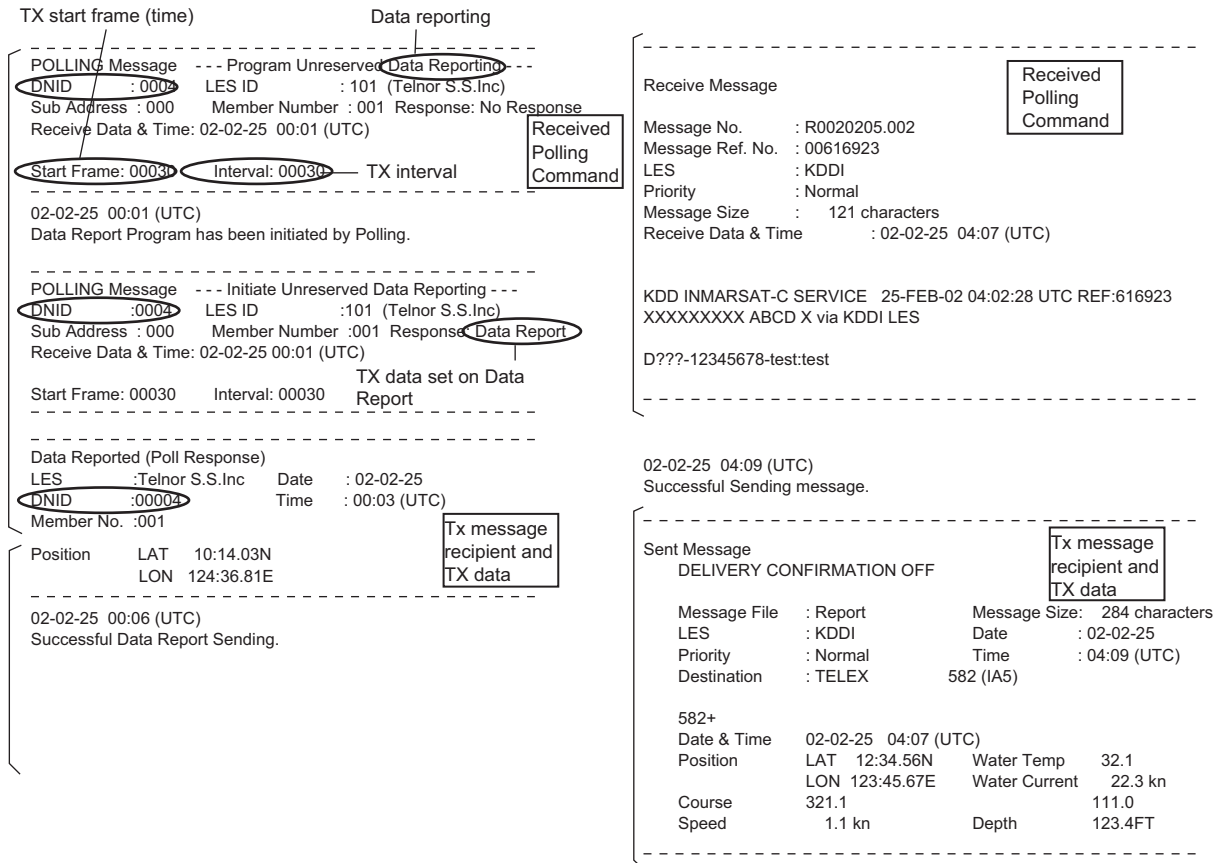

6.3 DNID (Data Network Identification)

When you make a contract with an information provider, DNIDs are downloaded from the information provider to the FELCOM, via the appropriate LES.

Up to 64 DNIDs can be downloaded to the FELCOM. You can see which DNIDs are stored by following the procedure shown below.

6.3.1 How to display DNIDs

You need to make a contract with an LES to exchange data within a group. The LES sends a DNID (Data Network Identification) number to each member of the group. The FELCOM can store a maximum of 64 DNIDs.

Press the **F5** and **4** keys to show the [Data Network ID] list.

No.	Act	DNID	LES	Subaddr	Member	Text
01	*	01000	002	000	235	
02	24h	01001	001	001	085	
03	STP	01002	102	002	215	
04		01003	131	003	033	
05	*	01004	202	004	227	
06	24h	01005	210	000	013	
07	STP	01006	302	001	079	
08		01007	304	002	089	

“Act” indications and their meanings

Asterisk: Enabled DNID

No indication means disabled DNID.

24h: Enabled DNID. TX cycle changes every 24 hours.

STP: Enabled DNID. TX temporarily disabled.

6.3.2 How to enable, disable DNIDs

Note: The [Disable], [Enable (24-hour)] and [Enable (Temporary Stop)] settings are for LRIT only. Only use these settings with a DNID for LRIT.

- 1) When anchored or docked, the [Enable (24-hour)] and [Enable (Temporary Stop)] settings can be used to temporarily stop of send 24-hour interval reports.
- 2) When the setting is changed from [Enable (24-hour)] or [Enable (Temporary Stop)] to [Enable], reports are sent at 6-hour intervals again. Where DNID is set to a DNID other than for LRIT and [Enable (24-hour)] or [Enable (Temporary Stop)] is selected, change the setting to [Enable] then ask the administrator for a compatible DNID for LRIT and request a polling command from the land station.
- 3) The interval reports can be stopped by selecting [Disable]. Interval reports will not be sent after reverting the setting to [Enable]. To reinstate the interval reports, change the setting to [Enable] then ask the administrator for a compatible DNID for LRIT and request a polling command from the land station. Where the DNID is not compatible with LRIT, follow the procedure mentioned above, even when selecting [Disable].

A DNID can be enabled or disabled as follows:

1. Press the **F5** and **4** keys to show the [Data Network ID] list.
2. Select the DNID to process then press the **Enter** key. A password input screen appears.



Description of each menu item

Menu	Description
[Enter Password]	You can enter a password or set a password. For details, see step 3.
[Change Password]	A password change screen appears, where you can change your current password. Enter your current password in the [Current Password] field and a new password in the [New Password]. Enter the same password as [New Password] in the [Confirm Password] field, then press the Enter key. <div data-bbox="1027 748 1434 853" style="border: 1px solid black; padding: 5px; margin-top: 10px;"> Change Password Current Password ***** New Password ***** Confirm Password ***** </div>
[Clear Password]	If you forget your password, you can clear it. The response code is required to delete your password. Contact a FURUNO agent to obtain the response code. Enter the response code in the [Response Code] field, then press the Enter key. <div data-bbox="1034 1021 1437 1099" style="border: 1px solid black; padding: 5px; margin-top: 10px;"> Clear Password Challenge Code CAC0A45C Response Code █ </div>

3. Select the [Enter Password] and press the **Enter** key. If you have already set a password, a password enter screen appears. If you have not been set a password, a password setting screen appears.



Password enter screen

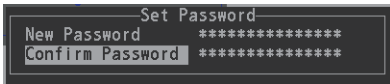

Password setting screen

Note: No password is set at the factory default. For enhanced security, be sure to set a password refer to the following steps.

How to set the password

- 1) Enter a password to be set in the [New Password] field.
- 2) Enter the same password again in the [Confirm Password] field, then press the **Enter** key.

6. DATA REPORT AND POLLING

4. Enter the password you have set on the password enter screen.
If the password is correct, the screen shown below appears. (If the password is wrong, the error message "Incorrect password." appears.)

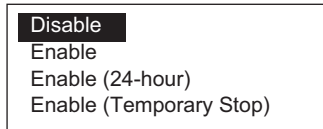

5. Select applicable item then press the **Enter** key.
Disable: DNID disabled, Enable: DNID enabled
Enable (24-hour): DNID enabled (TX cycle changes every 24 hours.)
Enable (Temporary Stop): DNID enabled (TX temporarily stopped)
6. The [Update] window appears. [Yes] is selected; press the **Enter** key.

6.4 EPADR (Enhanced Pre-Assigned Data Reporting)

EPADR increases the efficiency of maritime data reporting, allowing vessels using satellite services to reliably send position reports and comply with the International Maritime Organization's (IMO) new Long Range Identification and Tracking (LRIT) regulations.

6.4.1 How to prepare a data report

1. Press the **F5** and **3** keys to show the [EPADR] menu.
2. Press the appropriate numeric key to select a data report. For example, press the **1** key to select [EPADR 1].

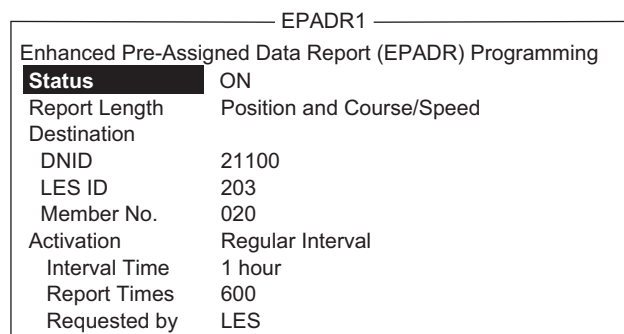

3. [Status] is selected; press the **Enter** key to open the status options window.
4. Select appropriate option then press the **Enter** key.
OFF: Data report off
ON: Data report on
5. Select [Report Length] then press the **Enter** key.
6. Select appropriate option then press the **Enter** key.
Position only: Own position
Position and Course/Speed: Position, course and speed
Position and Course/Speed and SEA INF: Position, course, speed, water temperature, tide, and depth
7. Select [Destination] then press the **Enter** key.
8. Select DNID desired then press the **Enter** key. (LES ID and Member No. are automatically selected according to DNID.)

9. Select [Interval Time] then press the **Enter** key.
10. Select an interval (15 min, 30 min, 1 hr, 2 hrs, 3 hrs, 4 hrs, 6 hrs, 8 hrs) then press the **Enter** key.
11. Select [Report Times] then press the **Enter** key.
12. Enter the number of times to transmit then press the **Enter** key. (Data is transmitted only the number of times specified.)

6.5 LRIT Compliance

6.5.1 LRIT overview

This equipment can function as a marine communications terminal for the LRIT (Long-Range Identification and Tracking) system, as prescribed by the IMO resolution MSC.202(81). The LRIT uses the FELCOM's Data Report/Polling feature for LRIT position reporting.

The LRIT system is fully automatic, thus no operation is required of the user. However, follow the guidelines shown below to use this equipment as an LRIT device.

The data listed below is sent by the FELCOM when it receives a command from the LRIT data center.

- ID number of this equipment
- Position of your ship
- Time of position

The FELCOM sends data at intervals between 15 minutes and 6 hours.

The FELCOM automatically receives commands (related to time of position reporting, transmission interval) from the LRIT data center. To receive the commands at all times, keep the equipment powered and logged in.

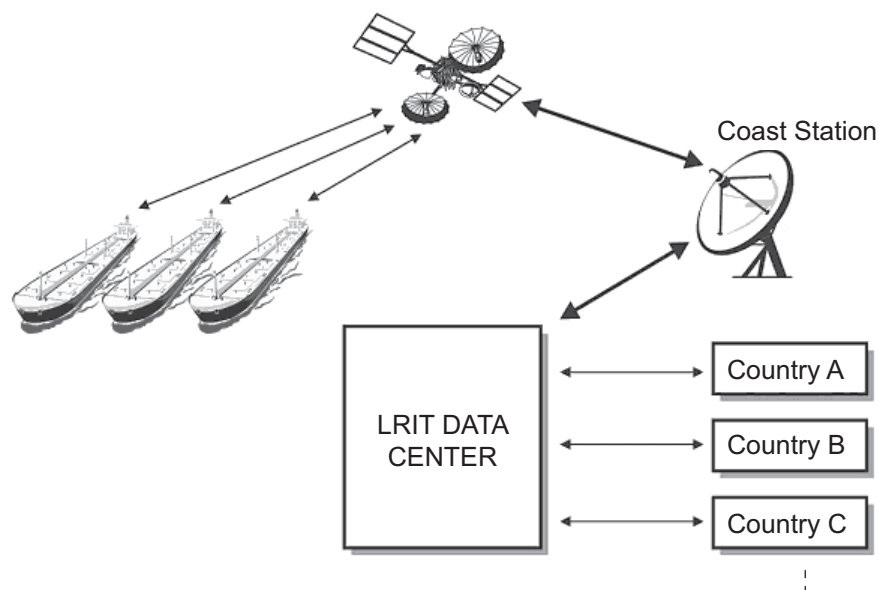

6.5.2 About the LRIT system

- Power the equipment and keep it logged in at all times except for special occasions such as when the ship is dry-docked for repairs. Position information is automatically sent at fixed intervals, thus no operation is required. However, keep the equipment in a ready state to received commands from the LRIT data center. Combined use for routine messages, distress messages and SSAS (Ship Security Alert System) is possible.
- The source of position data for this equipment can be its internal GPS receiver or external GNSS (Global Navigation Satellite System) equipment. For GNSS equipment, interface directly to the shipborne global navigation satellite system equipment.
- If external GPS equipment is used, set it to use WGS84 datum. Further, the output sentences should minimally be as follows:
 - Time data input: ZDA
 - Position data input: RMC or GGA and VTG (pair)
- This equipment and external GNSS equipment must be powered in the following manner.
 - If the above equipment is used as a GMDSS device also, connect them to an auxiliary power source (radio communications battery).
 - If the above equipment is not used as a GMDSS device, connect them to both main and emergency power sources (via AC/DC Power Supply Unit PR-240/241).
- If an error message appears, take the necessary measures to restore normal operation as soon as possible. Shown below are representative alarms.
 - **"WARNING: External NAV equipment failure."** Position data is not input from the external GNSS equipment. Check the GNSS equipment and the wiring between it and the FELCOM.
 - **"WARNING: Internal GPS UNIT failure."** Position data is not input from the internal GPS receiver. If this alarm occurs frequently, have the set checked.
 - **"WARNING: Synchronization loss."** Check the current Ocean Region.
 - **"WARNING: BBER over 80%. Scanning NCS start manually."** Problem with receiving the Inmarsat-C signal. Check if the current sea area is suitable for your position. If it is not, change the sea area. If the area is suitable and the alarm continues, check the antenna and antenna cable. Request service if the problem persists.

7. DISTRESS OPERATIONS

7.1 How to Send the Distress Alert

Set the LES where to send the distress alert, referring to steps 1-3 in section 7.2.

When a life-endangering situation arises on your vessel and you do not have the time to specify the nature of distress, do the following to send the distress alert to an LES without specifying the nature of distress.

1. Open the cover of the **DISTRESS** button on the Terminal Unit IC-218 or the Distress Alert/Received Call Unit IC-305.

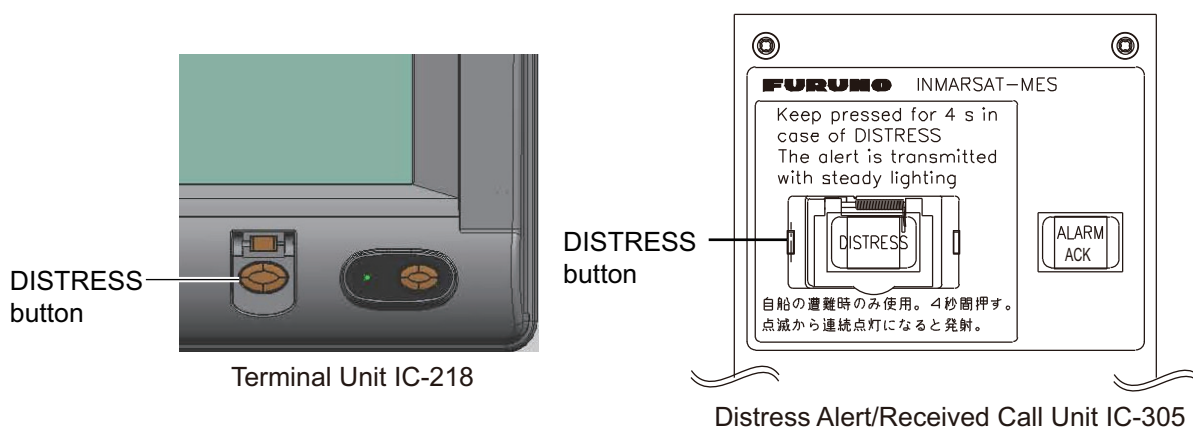

2. Press the **DISTRESS** button (approx. four seconds) until the lamp in the button lights continuously. The distress alert will not be sent until the lamp in the button lights continuously and the audio alarm sounds (no audio alarm is released on the IC-218). The message "Sending Distress Alert" (white characters on red background) appears on the screen while the distress alert is being sent.

Sending Distress Alert

Wait for acknowledgment of distress from an LES, which takes between 30 seconds and 10 minutes. When you receive acknowledgment of the distress alert from an LES, the message "Distress Acknowledgment Received" appears (white characters on red background) on the screen, the lamp in the **DISTRESS** button flashes slowly and the audio alarm sounds intermittently. To silence the audio alarm, press the **F10** key on the keyboard.

Distress Acknowledgement Received

7. DISTRESS OPERATIONS

The state of the LED in the **DISTRESS** button and the buzzer change according to the events in the distress transmission sequence.

Event in distress TX sequence	LED state	Buzzer state
Idle	OFF	OFF
Distress TX	Lighting	OFF
Distress ACK	1.2 s ON, 0.3 s OFF	1.2 s on, 0.3 s OFF

The **DISTRESS** button on the terminal unit of the FELCOM or the Distress Alert/Receive Call Unit IC-305 cannot be used to silence the audio alarm for incoming distress or EGC urgency broadcast. ***The DISTRESS button is for sending a distress alert for own ship. It cannot be used to silence the audio alarm. Use the F10 key on the keyboard to silence the audio alarm.***

7.2 How to Send the Distress Alert with Nature of Distress Specified

When a life-endangering situation arises on your vessel and there is time to specify the nature of distress and the recipient (LES) of the distress alert, send own ship data (position, time, speed and course) as follows:

1. Press the **F9** key to display the [Distress Alert Setup] screen.

LES ID	303 (KDDI)
Update Time	06:23 02-02-25 (YY-MM-DD)
Position	LAT 35:00N LON 135:00E
Protocol	Maritime
Nature	Undesignated
Course	187
Speed	10 kn

2. [LES ID] is selected; press the **Enter** key.
3. Select a suitable LES then press the **Enter** key.
4. Select [Update Time] then press the **Enter** key.
5. Enter the current time then press the **Enter** key.
Note: When the latitude and longitude position is entered manually, the time of the position will be the time entered here.
6. Select [Position] then press the **Enter** key.

7. Enter your current position in latitude and longitude then press the **Enter** key. Use the **S**, **N**, **E** and **W** keys to enter appropriate coordinate.

Distress Alert Setup	
LES ID	303 (KDDI)
Update Time	06:23 02-02-25 (YY-MM-DD) Over 24hrs ago
Position	LAT 35:00N (Manually input);
	LON 135:00E
Protocol	Maritime
Nature	Undesignated
Course	187
Speed	10 kn
<u>Press ESC key to register settings.</u>	
Manually input LAT/LON is maintained for one hour and during initial Distress Call sent within the one hour period. Navigational Data used in Distress Alerts is not automatically updated during this time.	

Appears when Distress Alert Position has not been updated for more than 24 hours.

Appears when latitude and longitude position is manually input.

Note 1: [Protocol] is fixed at [Maritime].

Note 2: Manually input LAT/LON is maintained for one hour and during initial Distress Call sent within the one hour period. Navigational Data used in Distress Alerts is not automatically updated during this time.

Note 3: The latitude and longitude position entered here will be reflected after step 15 is completed.

8. Select [Nature] then press the **Enter** key.
9. Enter applicable nature of distress then press the **Enter** key. If the nature of distress is not specified, [Undesignated] is automatically selected.
10. Select [Course] then press the **Enter** key.
11. Enter your course then press the **Enter** key.
12. Select [Speed] then press the **Enter** key.
13. Enter your speed then press the **Enter** key.
14. Press the **Esc** key to show the [Update] window.
15. [Yes] is selected; press the **Enter** key to register settings.

Note: If incorrect data is entered, Update is canceled and previous data is restored.
16. Open the cover of the **DISTRESS** button on the Terminal Unit IC-218 or the Distress Alert/Received Call Unit IC-305.
17. Press the **DISTRESS** button (approx. four seconds) until the lamp in the button lights continuously. The distress alert will not be sent until the lamp in the button lights continuously and the audio alarm sounds (IC-215 only; no sound for IC-218). The message "Sending Distress Alert" appears on the screen while the distress alert is being sent. When you receive acknowledgment of the distress alert from an LES, the message "Distress Acknowledgment Received" appears on the screen, the lamp in the **DISTRESS** button flashes slowly and the audio alarm sounds intermittently. To silence the audio alarm, press the **F10** key on the keyboard.

The **DISTRESS** button on the terminal unit of the FELCOM or the Distress Alert/Receive Call Unit IC-305 cannot be used to silence the audio alarm for incoming distress or EGC urgency broadcast. **The DISTRESS button is for sending a distress alert for own ship. It cannot be used to silence the audio alarm. Use the F10 key to silence the audio alarm.**

7.3 How to Prepare the Distress Message

The distress alert provides the minimum distress information: own vessel's ID, speed, course, L/L position and nature of distress. After receiving the distress alert acknowledgment from an LES and you are not pressed for time, you may send a distress message as below to provide more detailed information.

1. Press the **F1** and **1** keys to open a message screen.
2. Type the distress message. Below is an example.

```
MAYDAY MAYDAY MAYDAY

THIS IS..... Ship's name

I NEED HELP..... : Type of assistance required
```

3. Press the **F3** and **1** keys to select [Transmit Message].

Transmit Message

Priority	Normal	Size	24
Message File			
Station Name			
Destination Type	TELEX/MES		
Prefix Code			
Country/Ocean Code 82			
Destination 65-2111			
Modem Type			
Address			
Subject			
Attach File			
LES ID 303 (KDDI)			
Option ON			
Confirmation 00:00			
Send Delay Immediate			
Delivery Delay IA5			
Code			
[TRANSMIT]			

4. [Priority] is selected; press the **Enter** key.
5. Select [Distress] then press the **Enter** key.
6. Select [LES ID] then press the **Enter** key.
7. Select the LES where to send the distress message, preferably to the one where the distress alert was sent, then press the **Enter** key.
8. Select [TRANSMIT] (at the bottom of the screen) then press the **Enter** key.
9. The [Start] window appears and [Yes] is selected; press the **Enter** key to send the distress message.

The message "Distress Message Call Activated." appears (in red) while the distress message is being sent. When you receive acknowledgment from an LES, the message "Distress Message Call Acknowledged." appears and flashes.

Country/Ocean Code and Station ID are not required in a distress message.

7.4 How to Test the DISTRESS Button

The **DISTRESS** button on the terminal unit and the Distress Alert/Received Call Unit IC-305 may be tested as shown below without sending the distress signal. Note that the distress alert cannot be sent while testing the **DISTRESS** button.

1. Press the **F7** key to show the [Options] menu.

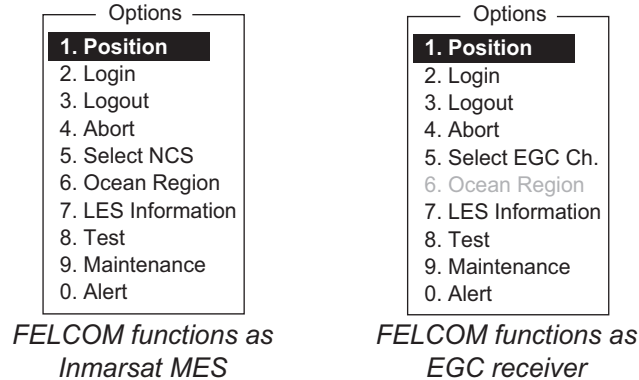

2. Press the **8** key to select [Test].

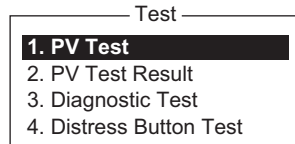

3. Press the **4** key to select [Distress Button Test]. [Yes] is selected in the [Start] window; press the **Enter** key to start the distress button test. The buzzer sounds repeatedly, signifying the start of the test mode. Further, the message "Distress buttons are under test. Cancel the test mode if a real distress alert needs to sent." appears (in red).

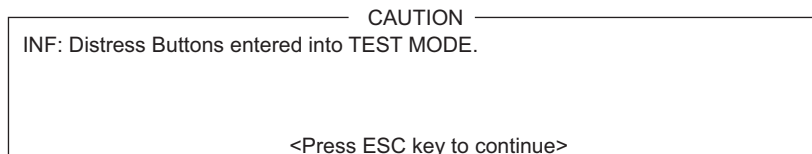

4. Open the **DISTRESS** button cover.
5. Press the **DISTRESS** button four seconds. The buzzer sounds rapidly for three seconds and then sounds repeatedly, as in step 3. The message "Distress Button works correctly." appears if the button is working properly.
6. Close the **DISTRESS** button cover.
7. To escape from the test, press the **Esc** key on the keyboard of the terminal unit twice. The test mode alarm stops and the message shown below appears to notify you that normal operation has been restored.

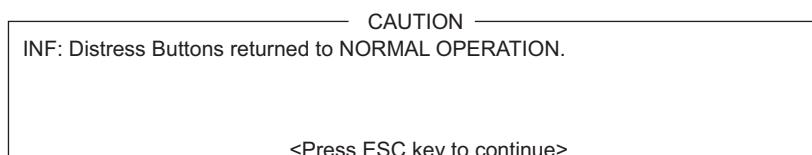

8. Long-press the **Esc** key to return to the standby display.

7. DISTRESS OPERATIONS

This page is intentionally left blank.

8. OTHER FUNCTIONS

This chapter describes how to

- Abort operation
- Scan NCS
- Select EGC and NCS channels
- Display LES information

8.1 How to Abort an Operation

You can abort transmission, receiving or scanning (on the NCS common channel) as follows:

1. Press the **F7** and **4** keys to show the [Options] menu and select [Abort].
2. The [Start] window appears and [Yes] is selected; press the **Enter** key to abort current operation.

The message "FORCED CLEARING" replaces "SENDING" or "RECEIVING" at the bottom of the screen. When the process has been aborted, the message "Process Aborted. Press any key to escape." appears.

If aborting is attempted in modes other than those mentioned above, the message "Ignored: Can not abort current process." appears.

8.2 How to Scan NCS Common Channels

Scanning is possible when the FELCOM is in idle state and functions as an Inmarsat C receiver. If the FELCOM is not in idle state, the message "Ignored: MES is not idle." appears. Wait until the equipment becomes idle.

1. Press the **F7** and **6** keys to display the [Ocean Region] menu.

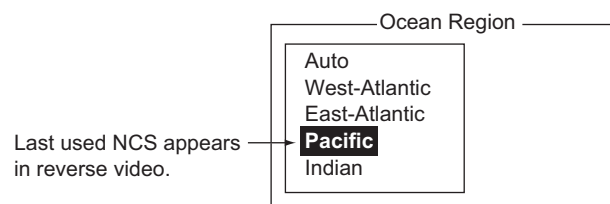

2. Select a NCS other than the one currently in use then press the **Enter** key. [Auto] scans all regions in turn.
3. [Yes] is selected; press the **Enter** key to start the scanning.
4. Long-press the **Esc** key to return to the standby display.

8.3 How to Select EGC Receiving Channel

EGC channel can be selected when the terminal unit is set to operate as an EGC-only receiver. However, this procedure is shown for reference only; currently there is only one EGC channel per NCS.

1. Press the **F7** and **5** keys to display the [EGC Channel List].

EGC Channel List			
ENTER: Set ESC: Quit			
11080*	12580*	10840*	11088*

2. Select a desired channel then press the **Enter** key.
3. Long-press the **Esc** key to return to the standby display.

8.4 How to Select NCS Channel

You may select NCS common channel as shown below. Currently, each satellite sends one global beam. In the future, the satellites will transmit multiple spot beams, namely, the NCS will have multiple channels.

1. Press the **F7** and **5** keys to display the [NCS Channel List].

NCS Channel List							
ENTER: Set ESC: Quit							
No	AORW/AMER	AORE	POR/APAC	IOR/EMEA			
ID	FREQ	ID	FREQ	ID	FREQ	ID	FREQ
01	044 11080*	144 12580*	244 12580*	344 10840*			
02	0	1	2	3			
03	0	1	2	3			
04	0	1	2	3			
05	0	1	2	3			
06	0	1	2	3			
07	0	1	2	3			
08	0	1	2	3			

2. Select a desired channel then press the **Enter** key.
3. Long-press the **Esc** key to return to the standby display.

8.5 How to Find LES Information

Each time you log in LES data is automatically downloaded through the NCS common channel to the FELCOM, and saved to the LES Information display. You may view this display as follows:

1. Press the **F7** and **7** keys to display the [LES Information] screen.

B8-B1
LES Information

LES ID	Name	Status	Services	TDM Ch.
201	Telnor S.S.Inc	11111000	AS----EL	11982
202	Stratos M.N.	11111000	AS----EL	11826
203	KDDI	11111000	AS----EL	11806
204	Telnor S.S.AS	11111000	AS----EL	11762
208	Korea Telecom	11111000	AS----EL	11778
210	Singapore T.	11111000	AS----EL	11842
211	Beijing Marine	11111000	AS----EL	11754
212	Xantic	11111000	AS----EL	11802

2. Use the \uparrow and \downarrow keys to scroll the list.
3. Long-press the **Esc** key to return to the standby display.

Description of status

Bit No.	Status	Flag	Meaning
B8	Return link speed	1	600 bps
		0	300 bps
B7	Operational or spare satellite operation	1	Operational
		0	Spare
B6	LES status	1	In service
		0	Out of service
B5	LES status	1	Clear
		0	Congested
B4	For LES use	1	Terrestrial links open
		0	Terrestrial links closed
B3-1	Spare	1	
		0	

8. OTHER FUNCTIONS

Description of services

Bit No.	Flag	Meaning	Flag
1B8	1	Maritime distress alerting	A
	0	No Maritime distress alerting	None
1B7	1	SafetyNET traffic	S
	0	No SafetyNET traffic	None
1B6	1	Inmarsat C traffic	C
	0	No Inmarsat C traffic	None
1B5	1	Store and forward	T
	0	No Store and forward	None
1B4	1	Half duplex	H
	0	No Half duplex	None
1B3	1	Full duplex	D
	0	No Full duplex	None
1B2	1	Closed network	N
	0	No Closed network	None
1B1	1	FleetNET traffic	F
	0	No FleetNET traffic	None
2B8	1	Prefixed Store and forward message supported	P
	0	No Prefixed Store and forward message supported	None
2B7	1	Land mobile alerting	No use.
	0	No Land mobile alerting	
2B6	1	Aero-C service supported	No use
	0	Aero-C service not supported	
2B5	1	ITA2 transmission supported	I
	0	ITA2 transmission not supported	None
2B4	1	Data transmission supported	B
	0	Data transmission not supported	None
2B3	1	Basic X400 supported	X
	0	Basic X400 not supported	None
2B2	1	Enhanced X400 supported	E
	0	Enhanced X400 not supported	None
2B1	1	Low power C MES supported	L
	0	Low power C MES not supported	None

9. E-MAIL BY PC

9.1 Introduction

This FELCOM incorporates various e-mail protocols including POP3 and SMTP. Connected to a LAN via the Ethernet(10Base-T) port on a PC, the FELCOM can send and receive e-mail using the PC's e-mail application.

9.1.1 Overview of mail functions

- Mail gateway
Received mail may be forwarded to a specific mail server.
- Selective forwarding
Received mail which contains a keyword can be forwarded to the mail address which appears after the keyword in a message.
- Access restriction
A specific PC on a network can be designated to send mail.
- Automatic attachment decoding
MIME-encoded mail sent from a network can be automatically decoded by UUEN-CODE or BINARY decoding format.
- Outgoing message size restricting
The administrator of this FELCOM can specify maximum outgoing message size (Max. size 32KB) allowable for the PC e-mail client. This allows control over the size of mail messages which can be sent by the PC e-mail client.

9.1.2 E-mail restrictions

The Inmarsat C e-mail system has restrictions not found on the land-based e-mail system. Further there are some restrictions which apply to this FELCOM.

- Use 7-bit characters in the Subject field, text and attachment. Some LES may not use 8-bit characters (Japanese, etc.). Since most LES use 7-bit characters in the header, 8-bit characters may not be properly received.

Space	(0	8	@	H	P	X	`	h	p	x
!)	1	9	A	I	Q	Y	a	i	q	y
"	*	2	:	B	J	R	Z	b	j	r	z
#	+	3	;	C	K	S	[c	k	s	{
\$,	4	<	D	L	T	\	d	l	t	
%	-	5	=	E	M	U]	e	m	u	}
&	.	6	>	F	N	V	_	f	n	v	~
'	/	7	?	G	O	W	-	g	o	w	

9. E-MAIL BY PC

- The maximum number of simultaneous transmissions is 32. Any simultaneous transmission in excess of that amount will not be sent. When transmitting, wait until the message "Successful Sending message." appears before transmitting another message.
- The maximum number of characters available for the Subject field is 60.
- The maximum number of characters per line is 1000. Characters in excess of 1000 will not be sent. Use maximum 1000 character per line.
- The maximum number of multiple addressees is 10. Any number in excess of that amount will not be sent.
- Destination cannot be specified as "Bcc:". "Bcc:" is automatically changed to "Cc:" because Bcc is not used in Inmarsat C.
- Set the encoding format on the PC's e-mail client to BASE64.

9.1.3 E-mail characteristics

- Confirm the port chosen to output received messages from the FELCOM. Set the [Message Output Port] on the [System Setup] menu to [INT] or [Auto].
- Set the mail format at the e-mail client for "Text." HTML increases communication charges because of its large size.
- The FELCOM does not have account management functions, for example, multiple accounts.
- All received and sent messages (incl. those on a LAN) are saved to the communications log. The log may be printed in real time or when desired.
- Sending and receiving stations should use the same font to read each others' messages. Use of different fonts may result in unreadable characters.
- When a file with an attachment is sent from land, the LES (e-mail service provider) separately forwards the file and attachment to the intended MES. The file name for the attachment as received at the FELCOM "ATTACH.DAT." For that reason request that land-based e-mail with attachment contain the attachment file name in the text of the message.
- File and accompanying attachment are sent separately regardless of the delivery address specified with the auto delivery keyword. The message file is delivered according to the auto delivery keyword setting and the attachment goes to the Mail Address set on Mail Gateway.

9.2 How to Connect the FELCOM to a Single PC

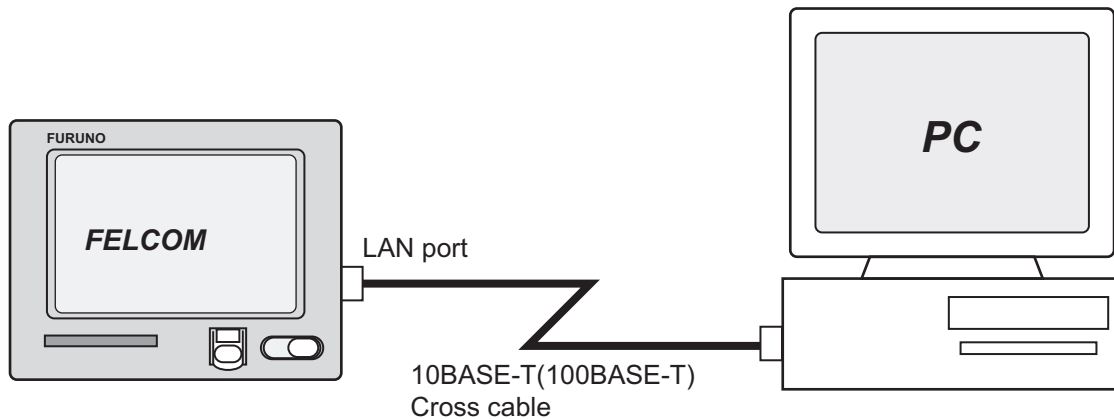

Parts required

- 10BASE-T or 100BASE-T cross cable
- PC (with LAN port or LAN card)

Wiring

Remove the plate from the LAN port at the rear of the terminal unit. Connect the cross cable between the LAN port on the terminal unit and the LAN port on the PC.

Settings at the FELCOM

Default settings are as below. It is not necessary to set IP address and subnet mask if their default values are to be used.

IP address: 172.31.16.2

Subnet mask: 255.255.0.0

Message size: 8 KB*

Attachment decoding format: UUENCODE**

* Setting may be changed. See section 9.3.5.

** Setting may be changed. See section 9.3.6.

Settings at the PC

Set network settings on the PC. For details refer to the PC's owner's manual.

IP address: 172.31.16.100

Subnet mask: 255.255.0.0

9.3 Function Settings

For network setting, consult your shipboard LAN administrator.

9.3.1 How to set IP address and subnet mask

Turn off DHCP from the [Network] menu to set IP address or subnet mask.

Also, if another device in the network shares the same IP address with the FELCOM 18, the message "Duplicate IP address detected." appears. If it is necessary to change the IP address of the FELCOM 18, follow the procedure below.

1. Press the **F8** and **1** keys to show the [System Setup] menu.
2. Select [Network Setup] then press the **Enter** key.
3. Select [Network] then press the **Enter** key.
4. [IP Address] is selected; press the **Enter** key.
5. Enter IP address then press the **Enter** key.
6. Select [Subnet Mask] then press the **Enter** key.
7. Enter subnet mask then press the **Enter** key.
8. Press the **Esc** key to show the [Update] window.
9. [Yes] is selected; press the **Enter** key. If you changed the IP address a message asks you to restart the FELCOM. Press the **Esc** key to restart the FELCOM. If only the subnet mask setting was changed go to the next step.
10. Long-press the **Esc** key to return to the standby display.

Network	
IP Address	172. 31. 16. 1
Subnet Mask	255. 255. 0. 0
DHCP	OFF
Gateway	. . .

9.3.2 DHCP setting

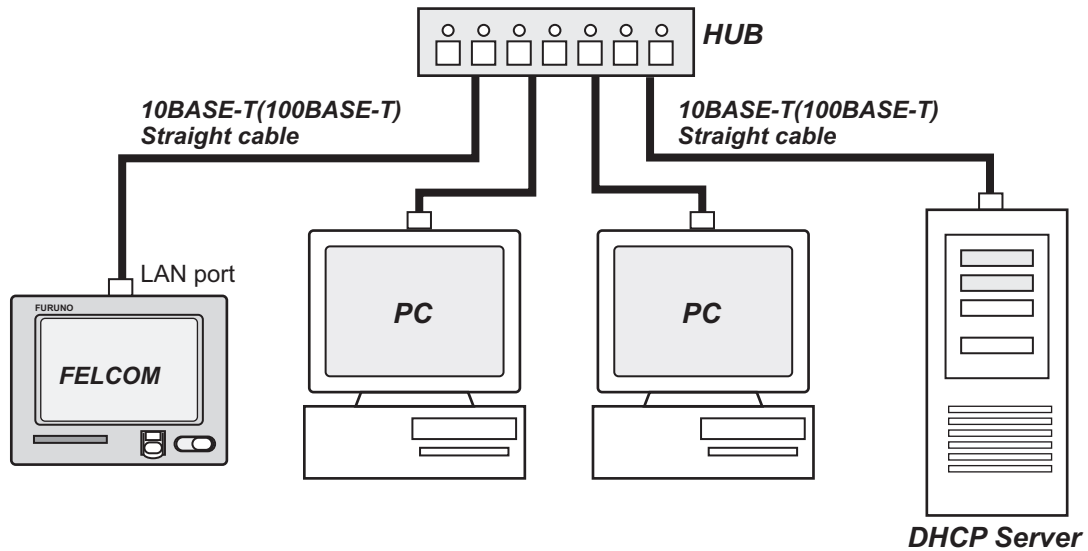

1. Press the **F8** and **1** keys to show the [System Setup] menu.
2. Select [Network Setup] then press the **Enter** key.
3. Select [Network] then press the **Enter** key.
4. Select [DHCP] then press the **Enter** key.
5. Select [ON] then press the **Enter** key.
6. Press the **Esc** key to show the [Update] window.
7. [Yes] is selected; press the **Enter** key. A message asks you to restart the FELCOM.
8. Long-press the **Esc** key to return to the standby display.
9. The terminal unit is restarted. After restarting is completed, confirm that IP address and subnet mask have been assigned.

9.3.3 Gateway setting

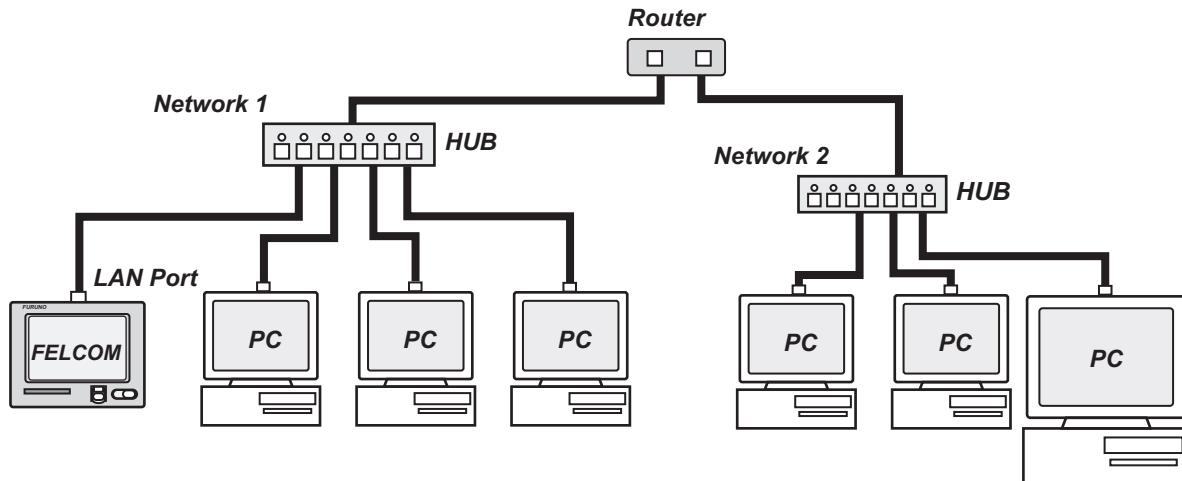

1. Press the **F8** and **1** keys to show the [System Setup] menu.
2. Select [Network Setup] then press the **Enter** key.
3. Select [Network] then press the **Enter** key.
4. Select [Gateway] then press the **Enter** key.
5. Enter the gateway address then press the **Enter** key.
6. Press the **Esc** key to show the [Update] window.
7. [Yes] is selected; press the **Enter** key. A message asks you to restart the FELCOM.
8. Press the **Esc** key to restart the FELCOM.

9.3.4 How to restrict access

Specify the IP address of the PC which is to be used to send and receive e-mail. A PC not specified cannot send e-mail but it can receive e-mail. If no IP address is specified, all PCs connected to the LAN can send and receive e-mail.

For example, the IP address of the PC allowed to perform e-mail functions is 172.31.16.5. Then, only that PC on the LAN can send mail.

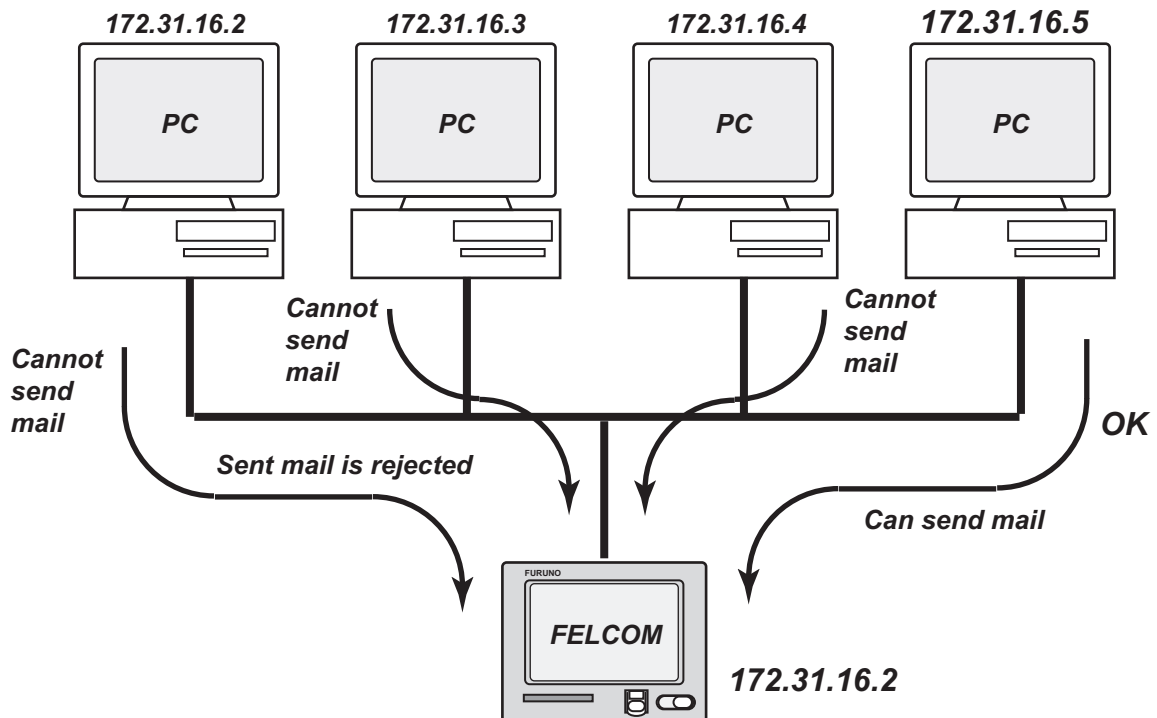

1. Press the **F8** and **1** keys to show the [System Setup] menu.
2. Select [Network Setup] then press the **Enter** key.
3. Select [Mail Gateway] then press the **Enter** key.

Mail Gateway	
SMTP Enable IP Address
Send Limit Size (KB)	8
Attach	UUENCODE
Delivery To	Server
Server IP
Address Mode	FIXED
Mail Address	
Auto Delivery Keyword	

4. Select [SMTP Enable IP address] then press the **Enter** key.
5. Enter IP address of PC which is to send e-mail then press the **Enter** key.
6. Press the **Esc** key to show the [Update] window.
7. [Yes] is selected; press the **Enter** key.
8. Long-press the **Esc** key to return to the standby display.

9.3.5 How to restrict the size of outgoing messages

The FELCOM administrator may limit the size of outgoing messages. When a PC client attempts to send an e-mail message which is larger than permitted, the message "Data size too large" appears and the message is not sent.

Attachments are encoded, which increases messages by 1.5 times.

1. Press the **F8** and **1** keys to show the [System Setup] menu.
2. Select [Network Setup] then press the **Enter** key.
3. Select [Mail Gateway] then press the **Enter** key.
4. Select [Send Limit Size (KB)] then press the **Enter** key.
5. Select the maximum message size to send within shipboard LAN, among 2, 4, 6, 8, 10, 16 and 32 (KB), then press the **Enter** key.
6. Press the **Esc** key to show the [Update] window.
7. [Yes] is selected; press the **Enter** key.
8. Long-press the **Esc** key to return to the standby display.

9.3.6 How to automatically convert attachments

Using the default setting, mail (MIME encoded) sent from a PC in a network is encoded with UUENCODE. For Inmarsat C use UUENCODE.

If the intended receiver does not use UUENCODE, an attachment may be unreadable. In this case, change the encode format to BINARY and re-send the message. In the BINARY setting the attachment file name is not sent to the receiver. To switch to BINARY follow the procedure below.

Some LES do not use the BINARY format. Contact your LES for details.

1. Press the **F8** and **1** keys to show the [System Setup] menu.
2. Select [Network Setup] then press the **Enter** key.
3. Select [Mail Gateway] then press the **Enter** key.
4. Select [Attach] then press the **Enter** key.
5. Select the encoding format (UUENCODE or BINARY) then press the **Enter** key.
6. Press the **Esc** key to show the [Update] window.
7. [Yes] is selected; press the **Enter** key.
8. Long-press the **Esc** key to return to the standby display.

9.3.7 How to connect the FELCOM to the shipboard LAN mail server

When a mail server is installed on a LAN, received mail is forwarded to the mail server via the LAN. The illustration on the next page shows how mail is forwarded to the mail server.

Mail server: 172.32.16.10

LAN domain name: ship.furuno.co.jp

Forwarding mail address: felcom@ship.furuno.co.jp (IP Address: 172.31.16.2)

If there is no mail server, disregard the procedure below.

1. Press the **F8** and **1** keys to show the [System Setup] menu.
2. Select [Network Setup] then press the **Enter** key.
3. Select [Mail Gateway] then press the **Enter** key.
4. Select [Delivery To] then press the **Enter** key.
5. Select the location where to deliver e-mail then press the **Enter** key.
PC Mailer: A mail-dedicated PC is connected to the FELCOM. The mail received by the FELCOM can be read by the PCs.
Server: The FELCOM is connected to mail server connected to a LAN. Mail received by the FELCOM is forwarded to the mail server.
6. Select [Server IP] then press the **Enter** key.
7. Enter server IP address then press the **Enter** key.
8. Select [Address Mode] then press the **Enter** key.
9. Select [Fixed] or [Auto] as appropriate and then press the **Enter** key.
Auto: When the keyword (entered in Auto Delivery Keyword) is found in the text of a message, the message is sent to the address which appears after the keyword. If the keyword is not found the mail is delivered to "Mail Address."
Fixed: Message is sent mail address specified in Mail Address.
10. Select [Mail Address] then press the **Enter** key.
11. Enter the IP address of the PC where the e-mail server is to forward e-mail then press the **Enter** key.
12. Press the **Esc** key to show the [Update] window.
13. [Yes] is selected; press the **Enter** key. The message "Press ESC key to Restart FELCOM18." appears.
14. Press the **Esc** key to restart.

9.3.8 Selective forwarding

When a keyword is found in a message the message is forwarded to the address which appears after the keyword. For example, the keyword is “g/+forward+/felcom@ship.furuno.co.jp”. The keyword “+forward” is found and the message is then forwarded to felcom@ship.furuno.co.jp.

To use selective forwarding with a land-based subscriber, you should request the land-based subscriber to do the following:

- Insert the keyword and mail address on the first line of the message.
- Do not insert a space in the keyword or mail address.
- Maximum number of mail addresses is 10.

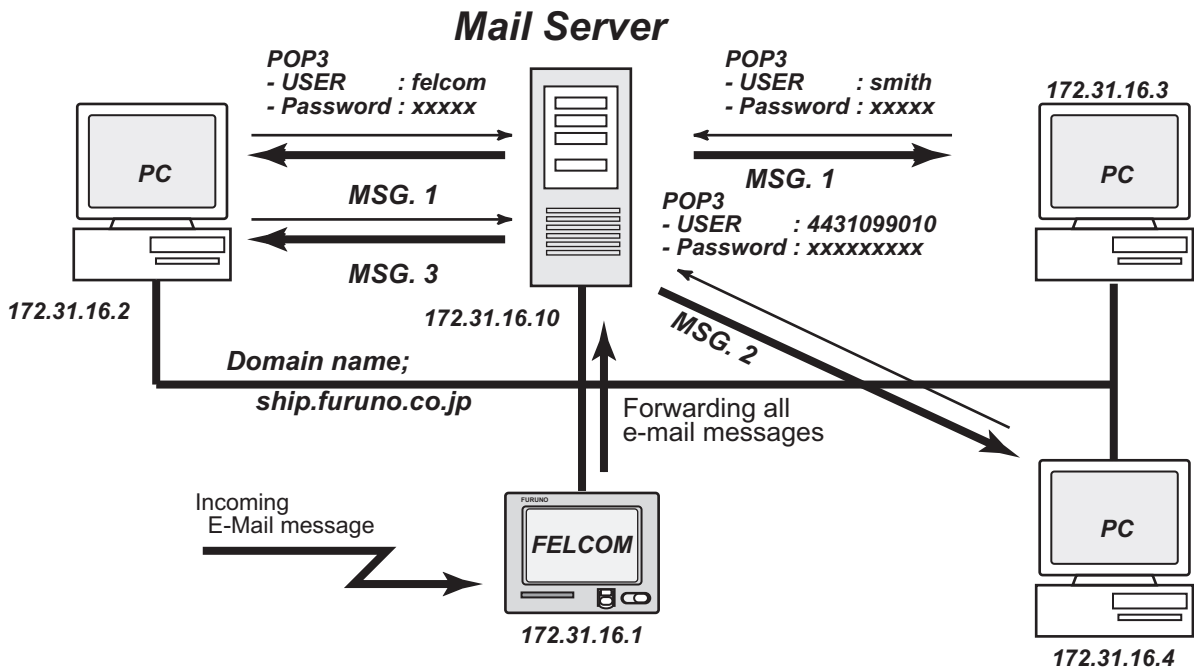

To: ****@***.***
Subject:

Test mail
/+forward+/felcom@ship.furuno.co.jp
/+forward+/smith@ship.furuno.co.jp
This is test message.....

MSG 1

To: ****@***.***
Subject:

Test mail
/+forward+/443 109910@ship.furuno.co.jp
This is test message.....

MSG2

To: ****@***.***
Subject:

Test mail
This is test message.....

MSG3

1. Press the **F8** and **1** keys to show the [System Setup] menu.
2. Select [Network Setup] then press the **Enter** key.
3. Select [Mail Gateway] then press the **Enter** key.
4. Select [Delivery To] then press the **Enter** key.
5. Select the location where to deliver e-mail then press the **Enter** key.
PC Mailer: A mail-dedicated PC is connected to the FELCOM. The mail received by the FELCOM can be read by the PCs.
Server: The FELCOM is connected to mail server connected to a LAN. Mail received by the FELCOM is forwarded to the mail server.
6. Select [Server IP] then press the **Enter** key.

7. Enter server IP address then press the **Enter** key.
8. Select [Address Mode] then press the **Enter** key.
9. Select [Auto] then press the **Enter** key. ([Fixed] delivers messages to the PC specified in [Mail Address].)
10. Select [Mail Address] then press the **Enter** key.
11. Enter the mail address corresponding to the mail server which is to receive mail then press the **Enter** key. Mail that does not have the keyword will be sent to this address.
12. Select [Auto Delivery Keyword] then press the **Enter** key.
13. Enter auto delivery keyword. Enter characters (incl. symbol) not normally found in your e-mail documents. Maximum 15 characters may be entered. Upper and lower case letters are not distinguished in the search for keyword.
14. Press the **Esc** key to show the [Update] window.
15. [Yes] is selected; press the **Enter** key. A message asks you to restart the FELCOM.
16. Press the **Esc** key to restart the FELCOM.

9.4 Example of How to Set E-mail Client

Note: For network settings contact your LAN administrator.

See the owner's manual of the PC for how to set up for communications via a LAN. The settings in the table are applicable when [Delivery To] in the [Mail Gateway] menu is set to [PC Mailer].

Item	Setting	Remarks
POP3 server	FELCOM's IP address	
POP3 port no.	110	Cannot be changed.
SMTP server	FELCOM's IP address	
SMTP port no.	25	Cannot be changed.
User account	IMN no.	Cannot be changed.
POP3 password	IMN no.	You can change the password you have already set. For how to change the password, refer to subsection 9.4.1. Note: No password is set at the factory default. For enhanced security, be sure to set a password.
Mail Address	Mail address of LES used for communications	The receiver is not informed of the mail address. The e-mail station through which the e-mail was forwarded is sent to the receiver.
Signature	Any	Signature is not passed to the receiver.

Item	Setting	Remarks
Check-for-incoming-mail interval	Two minutes	The FELCOM's capacity for message storage is 32 KB. When the capacity is reached the oldest message is deleted to make room for the latest.

9.4.1 How to change the POP3 password

1. Press the **F8** and **1** keys to show the [System Setup] menu.
2. Press ↓ to select [Command Window], and then press the **Enter** key.
3. Enter the "POP3 PASSWORD" on the [Command Window] screen.
The current password appears and fields for entering the new password below it.
4. Enter the new password in the new password enter field and press the **Enter** key.
Note: To cancel the password change, press the **Enter** key without entering the new password.
5. Press the **Esc** key several times to close the menu.

9.5 SMTP Error Messages

The table below shows the SMTP error messages which may appear when communication error between the FELCOM and the e-mail client is found. Check the e-mail client whenever an SMTP error message appears.



Message	Meaning
Current LES out of service area.	Selected service provider is not within current ocean area.
Data size too large.	Size of message is larger than set with [Send Size Limit] on the [Mail Gateway] menu.
Illegal address.	Invalid character(s) used in delivery address, or invalid domain name (no period entered).
Mail data abnormal.	Abnormal mail header
No target address.	Delivery address has not been set.
Send message parameter mismatch.	Address parameter error
Send message type mismatch.	Address parameter error
Sorry, system busy now.	The Tx message queue is full.
Too many addresses	The number of delivery addresses is more than the system can handle.
Your address access denied.	The SMTP Enable IP Address is on.

10. MAINTENANCE AND TROUBLESHOOTING

This chapter provides the information necessary for the maintenance and checking of the FELCOM. Please review the safety information at the beginning of this manual before attempting any maintenance procedures.

10.1 General Checking and Maintenance

Turn off the power before conducting any maintenance procedures other than the cleaning of the terminal unit.

 WARNING	IMPORTANT
 ELECTRICAL SHOCK HAZARD Do not open the equipment (other than when installing flush mount hanger cover). Only qualified personnel can work inside the equipment.	Do not apply paint, anti-corrosive sealant or contact spray to coating or plastic parts. Those items contain organic solvents that can damage coating and plastic parts, especially plastic connectors.

How to clean the terminal unit

Wipe the LCD carefully to prevent scratching, using tissue paper and an LCD cleaner. To remove dirt or salt deposits, use an LCD cleaner, wiping slowly with tissue paper so as to dissolve the dirt or salt. Change paper frequently so the salt or dirt will not scratch the LCD. Do not use solvents such as thinner, acetone or benzene for cleaning; they can remove paint and marks or deform the equipment.

How to check connectors and ground terminal

Check that the connectors and earth terminal on the terminal unit are tightly fastened. If the copper strap (earth material) has rusted, clean it.

If the terminal unit cannot be turned on...

- Check if the fuse in the power cable has blown.
- Check if the power cable connector on the rear panel of the terminal unit is tightly fastened.
- Check if the ship's mains switchboard is turned on.
- If you still cannot turn on the power, have a qualified technician check the power voltage at the power connector on the rear of the terminal unit.

Antenna unit

Check the antenna unit yearly for rust, corrosion and chipped paint. If the antenna base has rusted or the paint has chipped, paint the affected area. Paint only the antenna base. Do not paint the radome. Paint on the radome can cause loss of sensitivity and crack the radome.

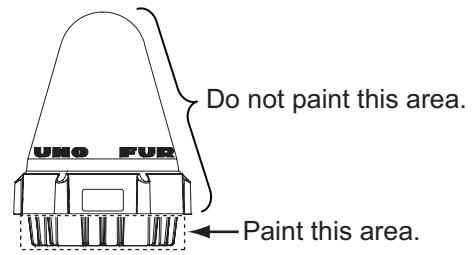

Also check the anti-corrosive sealant on the ground bolt for deterioration (peeling, cracking, etc.) every 3 to 6 months. If the deterioration is minor, re-apply the sealant. For serious deterioration, completely remove the sealant, then re-apply the sealant. Water leakage can corrode the bolt if it is not properly treated.

10.2 Diagnostics

10.2.1 Self test at power on

The terminal unit performs the ROM sum test and RAM read and write test at power up. If the test results are normal the equipment goes into standby. If error is found you cannot transmit.

10.2.2 Diagnostic

Confirm that "Current State: IDLE" appears at the bottom of the screen.

1. Press the **F7** and **8** keys to show the [Test] menu.
2. Press the **3** key to select [Diagnostic Test].
3. The [Start] window appears and [Yes] is selected; press the **Enter** key to start the test.

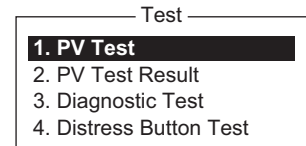

When the test is completed, the screen shows the test results.

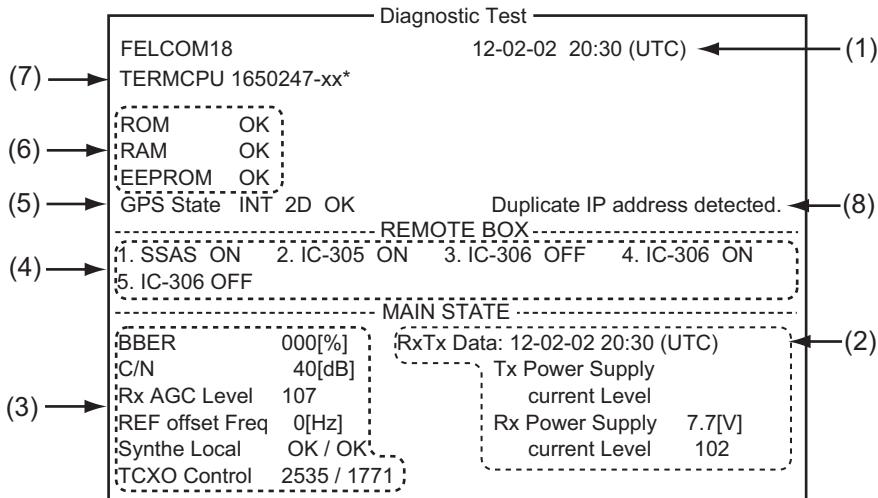

*xx=Version no.

(1)	Date and time of test
(2)	Date and time of most recent TX and RX and the power output and current level at that time.
(3)	Various levels and indications. See page 10-5 for description.
(4)	Status of equipment connected to the system.
(5)	Status of GPS navigator
(6)	Results for ROM, RAM and EEPROM check (OK: Normal, NG: No Good)
(7)	Program version of CPU in Terminal Unit
(8)	Duplicate IP addresses detected in the network. (Not shown unless duplicates are found.)

4. Press the **Esc** key to stop the test and return to the [Test] menu.

10.3 Performance Verification (PV) Test

After the FELCOM is installed, the installer usually confirms that it is functioning properly, by logging in and conducting the PV test. This test consists of receiving a test message from an LES, transmitting a message to the LES and a distress alert test.

The results of the test appear on the PV test result display.

The PV test cannot be conducted from an auxiliary terminal unit. Note that the test can also be initiated by an NCS.

10.3.1 PV test sequence

1. Select [PV Test] from the [Test] menu.
2. The MES requests an NCS to conduct the PV test.
3. The NCS acknowledges request for testing.
4. The MES, upon receiving acknowledgment from NCS, goes into pending state.
5. The NCS selects an LES to perform the test.
6. The LES transmits a test message to the MES.
7. The LES receives the test message.
8. The MES automatically transmits the distress alert test within two minutes after completion of step 7.
9. When the distress alert test is finished, the LES sends the results of the PV test to the MES.

10.3.2 PV test procedure

1. Confirm that the terminal unit is in idle condition and is logged in.
2. Press the **F7**, **8**, and **1** keys to enable the PV test.

3. The [Start] window appears and [Yes] is selected; press the **Enter** key to start the test. The [PV Test] screen appears and shows the message "Starting PV Test Process. Press any key to escape."
Note: If the terminal unit is not idle when the test is initiated, the screen displays "Ignored: MES is not idle."
4. Long-press the **Esc** key to return to the standby display.
5. The (automatic) testing sequence is as follows:
 - 1) The screen displays "Current State: IDLE (PENDING)" when you receive the acknowledge signal from the NCS.
 - 2) When preparations for testing have been completed, "Current State: TESTING" appears at the bottom of the screen. Further, the message "Automatic test mode: Normal communication disabled. Do not press any distress button unless you are in distress." appears.
 - 3) Receive a message from the LES. Send a test message to the LES.
 - 4) Then, the distress alert test is automatically conducted after you have sent a test message. Do not operate the equipment at this time.
 - 5) When testing has been completed, "Current State: IDLE" appears at the bottom of the screen.

10.3.3 How to show the PV test results

1. Press the **F7, 8** and **2** keys to show the PV test results.

PV Test Result	
	Ctrl+P: Print ESC: Quit
Test Date & Time	02-02-25 01:58 (UTC)
Attempts	First attempt
BBER	Pass
Shore-to-Ship Attempts	First attempt
Ship-to Shore Attempts	First attempt
Distress Alert	Pass (Test OK)
Signal Strength	Pass (Greater than Std level + 10dB)
Overall Result	Pass (Applicable tests pass)

2. Long-press the **Esc** key to return to the standby display.

How to read the PV test results

Test Date & Time: Date and time of test

Attempts: Number of times the PV test was conducted.

BBER: Bulletin Board Error Rate (%). "Pass" appears for no error.

Shore-to-Ship Attempts: Number of tests initiated by LES.

Ship-to-Shore Attempts: Number of tests initiated by MES.

Distress Alert: "Pass (Test OK)" appears for successful testing.

Signal Strength: "Pass" appears if signal strength is greater than standard level.

Overall Result: "Pass" appears for satisfactory completion of the test.

10.4 System Status Monitor

The system status monitor, which is always displayed, provides date, time, equipment status and navigation data.

File	Edit	Transmit	EGC	Reports	Logs	Options	Setup	Distress	StopAlarm
Date	(EXT)	Jan-12-12						IMN:	443156710
Time		01:32 (UTC)				BBER			000
Position	(EXT)	LAT 34:30.00N				C/N			OK (0 dB)
		LON 135:00.00E				Send Level			OK (0)
Waypoint	(EXT)	LAT				Rx AGC Level			OK (254)
		LON				REF Offset Freq			OK (0 Hz)
Course	(EXT)	345.5 DEG				Synthe Local			OK
Speed	(EXT)	10.2 kn				TCXO Control			131
Current NCS		344 (IOR/EMEA)	LOGOUT			Antenna Power Supply			OK(7.4V)
Current Channel		NCS CC							
Current TDM		NCS CC				Water Temperature (EXT)			68.2 DEG
MES Status		Idle				Water Current (EXT)			
GPS Status		****				Direction			232 DEG
						Speed			1.9 kn
DCE Memory		32818 Bytes free				Depth (EXT)			
Current State: IDLE		Retuning		Jan-12-12 01:32 (UTC)					
DCE F18 Ver. xx		NCS: IOR/EMEA LOGOUT		LAT: 34:30.00N					
		REC. MESSAGE EXIST		LON: 135:00.00E					

xx: Program Version No. of TERMCPU Board

How to read the system status monitor

Date: Current date.

Time: Current time.

Position: Own ship L/L position (either manual entry or automatic input by navigator).

Waypoint: L/L position of destination waypoint set on navigator.

Course: Course.

Speed: Ship's speed.

Current NCS: NCS your vessel is logged in with.

Current Channel: Channel in use.

Current TDM: Channel TDM.

MES Status: Operational status of MES.

GPS Status: Receiving signal status from GPS receiver.

CST: Cold Start.

ACQ: Acquired; Almanac data acquired.

IMP: Impossible; cannot receive GPS signal.

INT: Interrupted; object interfering with reception of GPS signal.

ALM: Receiving the almanac.

2D, 3D: Position-fixing method by 2D or 3D.

DCE Memory: Memory remaining in communication unit.

BBER: Bulletin Board Error Rate (%).

C/N: Check of circuit status with LES, receiving circuit in antenna unit and TERMCPU Board in terminal unit. OK appears for figure greater than 31.

Send Level: TX level check. At transmission, OK appears for figure greater than 100. At reception, 0 always appears.

Rx AGC Level: Check of the receiving circuit of the antenna unit and the TERMCPU Board in the terminal unit. OK appears for figure greater than 60.

REF Offset Freq: OK appears for figure lower than 150.

Synthe Local: Check of TERMCPU Board.

TCXO Control: Oscillator frequency control value.

Antenna Power Supply: NG appears for discontinuity or short in antenna cable. OK is shown if the antenna is receiving electrical power.

Water Temperature*: Water temperature.

Water Current*

Direction: Tidal current direction.

Speed: Tidal current speed.

Depth*: Depth of water.

* Requires data from appropriate sensor.

10.5 Current Position Log

Position is saved to the [Current Position Log] every hour, and the log stores the latest 100 positions. When the log becomes full, the eldest entry is automatically deleted and positions are renumbered.

To display the log, press the **F7**, **9** and **1** keys.

Current Position Log				
List				
No.	Latitude	Longitude	Op. Time(sec)	Date & Time(UTC)
001	34:44.47N	135:21.29E	0000916673	JAN-21-12 17:46
002	35:21.29N	135:22.02E	0000913073	JAN-21-12 18:46
003				
004				
005				
006				
007				
008				
009				
010				
Range:			Total: 2	
From No.	To No.			
[Ctrl]+[F]: Search				
[Ctrl]+[E]: Export [Ctrl]+[P]: Print				

Current Position Log description

List: Put the highlight cursor here to put the cursor in the list then press the **Enter** key.

No.: The number of the position, in three digits.

Latitude, Longitude: Latitude and longitude of the position.

Op. Time(sec): The number of seconds the power has been on since the commissioning.

Date & Time(UTC): Date and time of the position.

Range: Specify the range of positions to show, with [From No.] and [To No.]. Put the cursor on [From No.] (or [To No.]) then press the **Enter** key. Enter no. then press the **Enter** key.

Total: Total no. of positions saved to the log.

[Ctrl]+[F]: Search: Search for specific position no.

[Ctrl]+[E]: Export: Export the position nos designated with [From No.] and [To No.], to an SD card.

[Ctrl]+[P]: Print: Print the position nos designated with [From No.] and [To No.].

10.6 How to Replace the Fuse

The 15A fuse (for 12 VDC) or 7A fuse (for 24 VDC) in the power cable for the terminal unit protects the system from overcurrent and reverse polarity. If the fuse blows, find the cause before replacing it. If the fuse blows again after replacement, contact your dealer for advice.

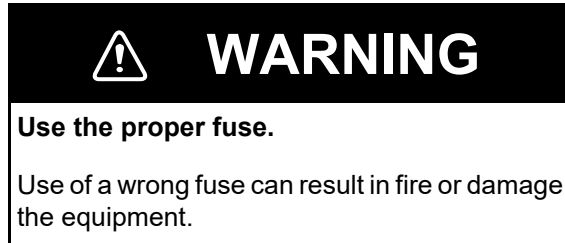

12 VDC

Code No.: 000-155-827-10

Type: FGBO-A 125V 15A PBF

24 VDC

Code No.: 000-155-831-10

Type: FGBO 125V 7A PBF

10.7 Alert and Warning Messages

This equipment displays alerts and warnings with pop-up messages. The tables which follow describe the alerts and warnings and the methods to restore normal operation. If normal operation cannot be restored, contact your dealer for advice.

10.7.1 Alert messages

Alert messages appear in the Alert pop-up, which is colored orange for Warning priority alerts or yellow for Caution priority alerts. One message appears per pop-up. When multiple alerts are generated together, the pop-up windows overlap one another. To close a pop-up, press the **Esc** key.

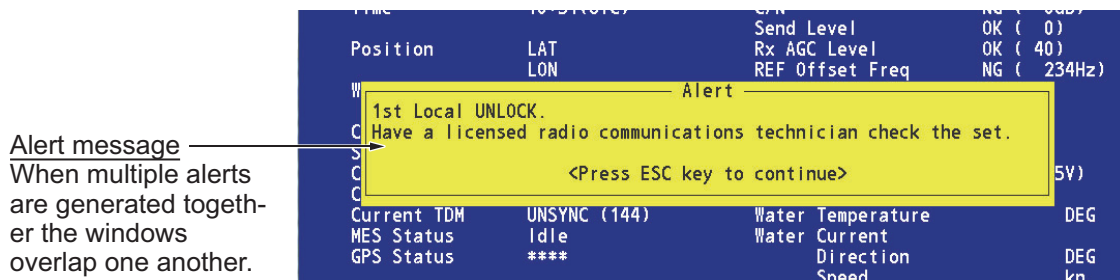

An alert message remains in the alert window until the alert condition is resolved. See subsection 10.7.2.

10.7.2 Alert window

The alert window displays unresolved alerts. To show the window, press [F7] and [0], or press [F12]. To return to the standby display, press the [ESC] key.

The alert windows display alerts in the order generated. Once an alert is resolved it is removed from the window. You can switch between alerts with [←], [→]. [←] for previous alert; [→] for next alert.

Note: Note: The alert code is displayed according to the alert mode set at installation. The alert code for the AMS mode is three digits, and the alert code for the BAM mode is 4 - 6 digits. See the alert list on page AP-33 for details.

AMS mode alert window

Below is an example alert list for the AMS mode. [→]: Next [←]: Previous







Code	Content	Alert	Date & Time
100	ANT power voltage abnormality.		19-10-15 17:16
500	Distress Msg Rx.		19-10-15 17:16
501	Distress Rx.		19-10-15 17:16
510	Urgent RX.		19-10-15 17:15
002	Syschronization loss.		19-10-15 17:16
001	EGC Synchronization loss.		19-10-15 17:14
632	External NAV UNIT failure.		19-10-15 17:13
630	Internal GPS UNIT failure.		19-10-15 17:12
641	ALARM UNIT connection abnormality.		19-10-15 17:12
Page:1 of 1 [ESC]:Close			Total: 9

BAM mode alert window

Below is an example alert list for the BAM mode.

Code	Pri.	Status	Content	Alert	Date & Time
3115	WAR.	Rec-Unack	ANT V abnormal.		19-10-15 17:16
3122-1	WAR.	Act-Unack	Distress Msg RX.		19-10-15 17:16
3122-2	WAR.	Act-Unack	Distress RX.		19-10-15 17:16
3122-3	WAR.	Act-Unack	Urgent RX.		19-10-15 17:15
630201	CAU.	Active	2nd Local UNLOCK		19-10-15 17:16
3116-2	CAU.	Active	Synchronization loss.		19-10-15 17:16
3116-1	CAU.	Active	EGC Synchronization loss.		19-10-15 17:14
630200	CAU.	Active	1st Local UNLOCK		19-10-15 17:13
630010	CAU.	Active	Invalid MES ID		19-10-15 17:12
3079	CAU.	Active	Can't print. (Offline/Paper low)		19-10-15 17:12
Page:1 of 2 [→]:Next [ESC]:Close					Total: 12

Alert status

	Alert	Icon
Act-Unack	Warning occurring (not confirmed in pop-up message)	
Silenced	Warning occurring (buzzer stopped by BAM system)	
Act-Ack	Warning occurring (confirmed in pop-up message)	
Act-RT	Warning occurring (Responsibility Transferred status)	
Rec-Unack	Warning resolved (not confirmed in pop-up message)	
Active	Caution occurring	

10.7.3 Warning messages

Warning messages are shown in a pop-up with the prefix "WARNING:" The messages are automatically scrolled to show the latest warnings. Warnings cannot be re-viewed once scrolled.

Error message	Meaning	Action
Cannot enter new DNID. Memory full for DNIDs.	Memory for DNIDs is full.	Delete unnecessary DNIDs to enter new ones.
Cannot enter new ENID. Memory full for ENIDs.	Memory for ENIDs is full.	Delete unnecessary ENIDs to enter new ones.
Cannot find NCS CC in all region. Scanning is continued.	No NCS found in region.	Scanning automatically continues.
Cannot find NCS CC in preferred region. Scanning all region is started.	NCS could not be found in region selected. Scanning started to find NCS.	If NCS could not be found, contact your dealer for advice.
Memory full for receiving msg.	The memory for RX messages is full.	Delete unnecessary RX messages.
Disk full. Can't write "filename". Memory full. Cannot save the new file.	The SD card has reached maximum capacity.	Delete unnecessary files or change the SD card.

10.8 Troubleshooting

If you suspect equipment trouble, first follow the troubleshooting information in the table below. If normal operation cannot be restored, do not attempt to check inside any unit. Contact a FURUNO agent or dealer for assistance.

Symptom	Cause, checkpoint	Remedy
The power cannot be turned on.	<ul style="list-style-type: none"> • Check that the power cable is firmly connected to the power input at the rear of the Communication Unit. • Check that the power for the FELCOM is on at the ship's switchboard. • Check for blown fuse in the power cable. 	<ul style="list-style-type: none"> • Reconnect the power cable if it has loosened. • Turn on the power at the ship's switchboard. • Referring to section 10.6, replace the fuse.
No communications. <ul style="list-style-type: none"> • Cannot receive EGC messages. • Cannot receive polling command. • Cannot receive e-mail. 	<ul style="list-style-type: none"> • Do the PV test. The [Overall Result] should be [Pass]. • Referring to section 2.5, confirm the following items. <ul style="list-style-type: none"> - C/N value is "OK". - You are logged in. 	<ul style="list-style-type: none"> • If the PV test result is [Fail], follow the information in subsection 10.3.3. • Check for interfering objects near the antenna. If interfering objects are present, relocate the antenna, referring to the installation manual.
Error message is displayed.	—	Refer to the Alert List in Appendix 7.

APPX. 1 MENU TREE

Default settings shown in bold italic.

F1: File

- 1. New
- 2. Open
- 3. Close
- 4. Save
- 5. Delete
- 6. Rename
- 7. Print
- 8. Remove SD Card
- 9. MIME (Decode)
- 0. Format SD

F2: Edit

- 1. Cut
- 2. Copy
- 3. Paste
- 4. Insert (With Citation)
- 5. Select All
- 6. Search or Replace
 - 1. Search
 - Search Word
 - Direction — ***Forward***, Back
 - 2. Replace
 - Search Word
 - Replace Word
 - Direction — ***Forward***, Back
 - Query or ALL — ***Query***, ALL
- 7. Goto Line
 - 1. Top of Text
 - 2. End of Text
 - 3. Goto Line — Chooses line to go to.
- 8. Time or Pos. Ins
 - 1. Time
 - 2. Position
- 9. Change Window

F3: Transmit

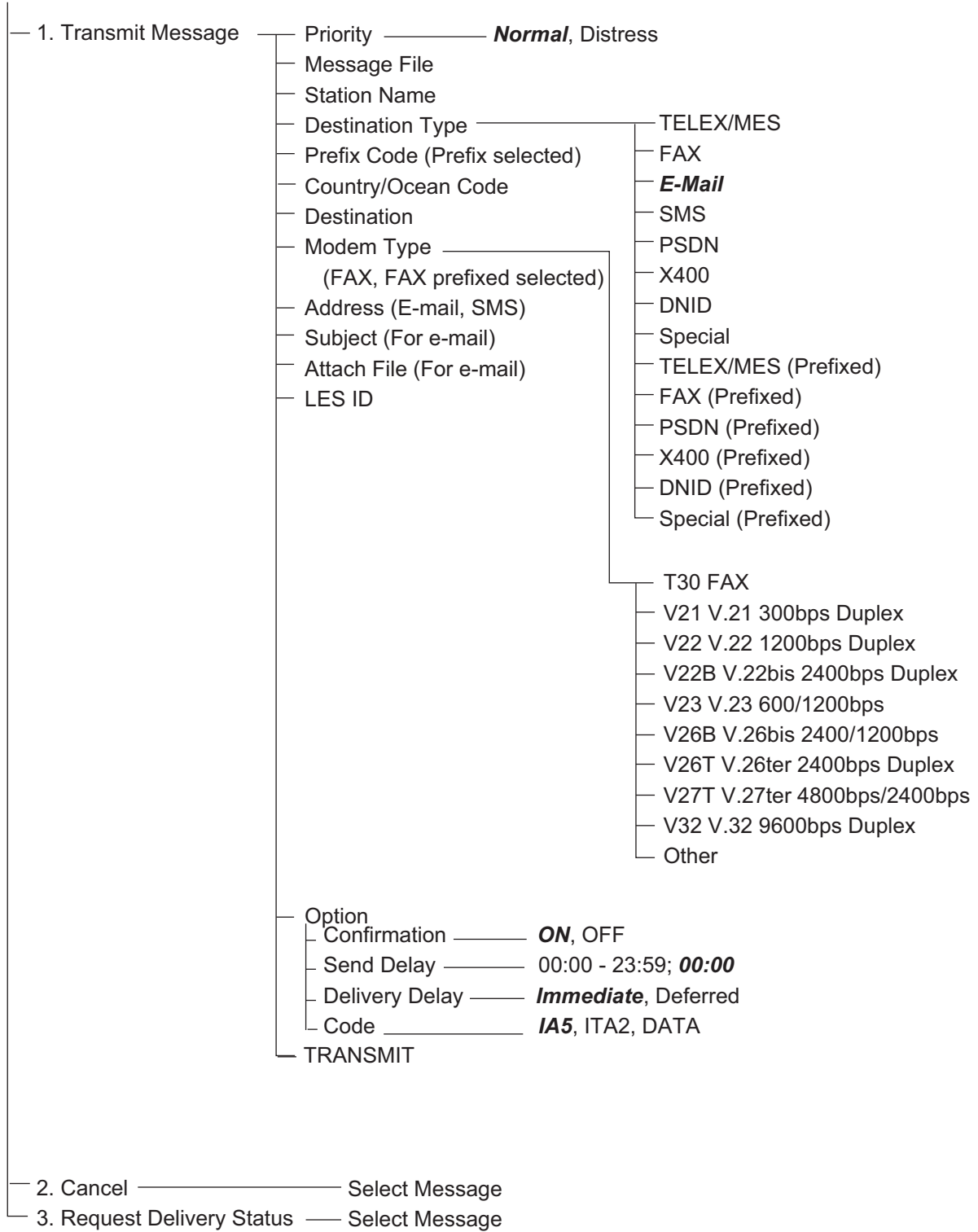

F4: EGC

- 1. Display EGC Message
- 2. EGC Network ID

F5: Reports

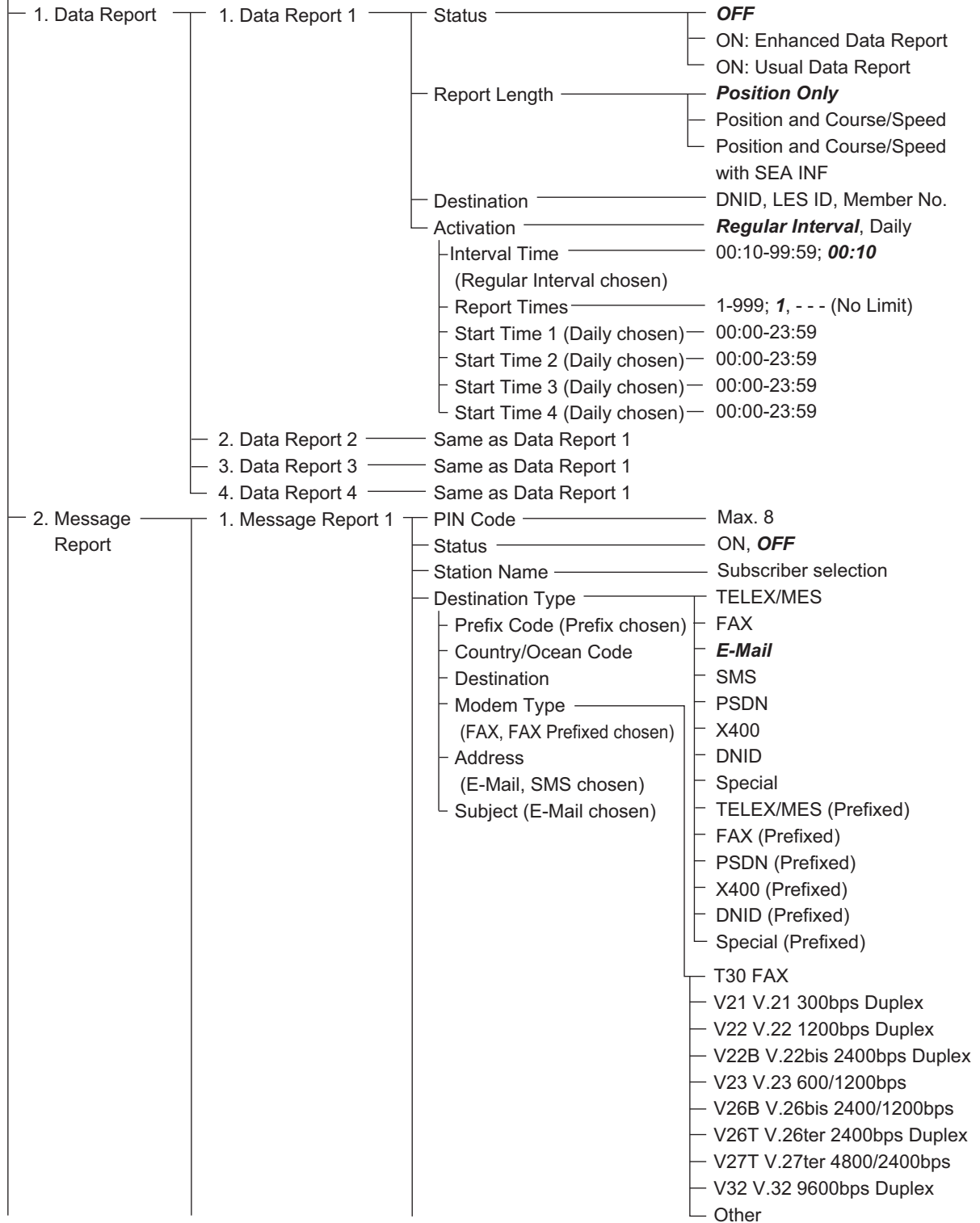

APPX. 1 MENU TREE

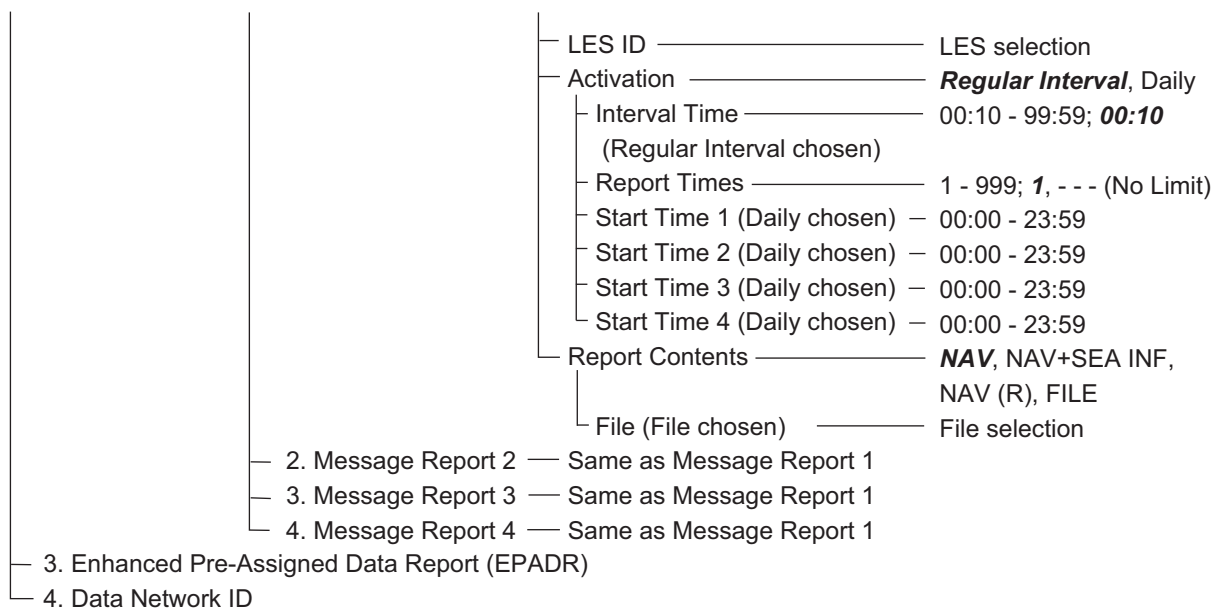

F6: Logs

- 1. Sent Messages
- 2. Received Messages
- 3. EGC Messages
- 4. Communication Log

F7: Options (FELCOM functions as Inmarsat MES)

- 1. Position
- 2. Login ————— **Yes**, No
- 3. Logout ————— **Yes**, No
- 4. Abort ————— **Yes**, No
- 5. Select NCS
- 6. Ocean Region — **Auto**, West-Atlantic, East-Atlantic, Pacific, Indian
- 7. LES Information
- 8. Test —————
 - 1. PV Test ————— **Yes**, No
 - 2. PV Test Result
 - 3. Diagnostic Test ————— **Yes**, No
 - 4. Distress Button Test ————— **Yes**, No
- 9. Maintenance — 1. Current Position Log
- 0. Alert

F7: Options (FELCOM functions as EGC receiver)

- 1. Position
- 2. Login ————— **Yes**, No
- 3. Logout ————— **Yes**, No
- 4. Abort ————— **Yes**, No
- 5. Select EGC Ch.
- 6. Ocean Region — **Auto**, West-Atlantic, East-Atlantic, Pacific, Indian
- 7. LES Information
- 8. Test —————
 - 1. PV Test ————— **Yes**, No
 - 2. PV Test Result
 - 3. Diagnostic Test ————— **Yes**, No
 - 4. Distress Alert Test ————— **Yes**, No
- 9. Maintenance — 1. Current Position Log
- 0. Alert

F8: Setup

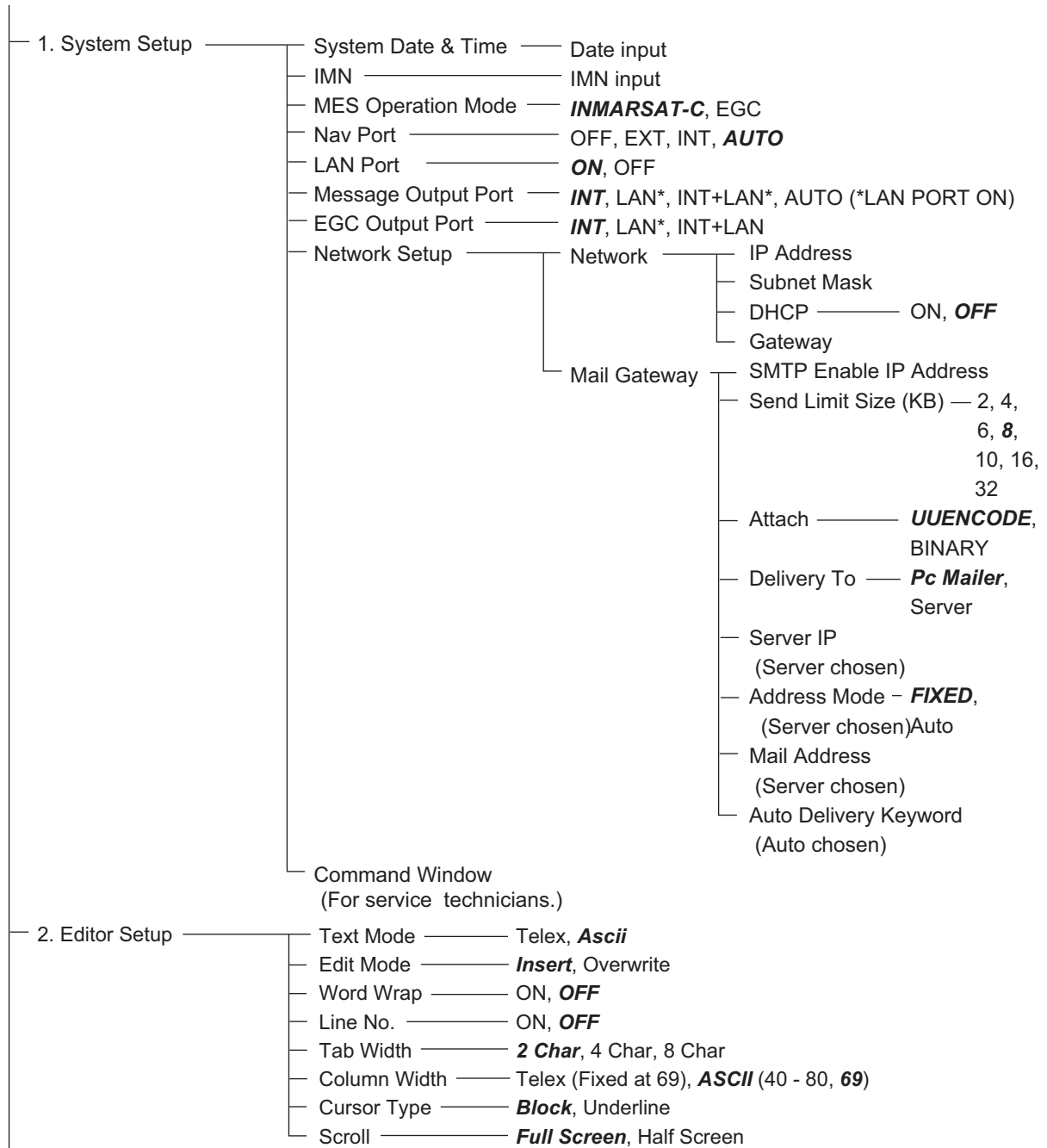

APPX. 1 MENU TREE

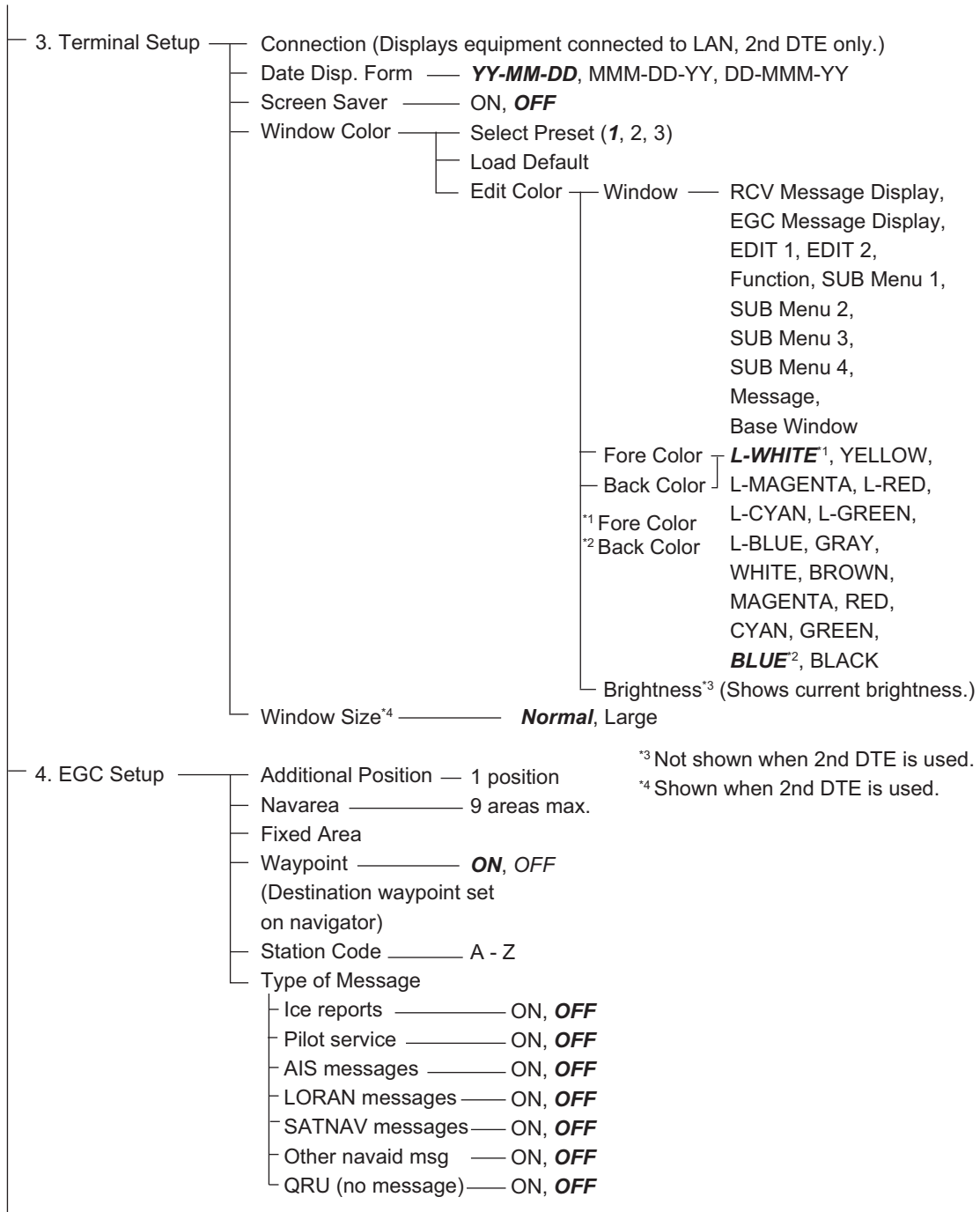

³ Not shown when 2nd DTE is used.

⁴ Shown when 2nd DTE is used.

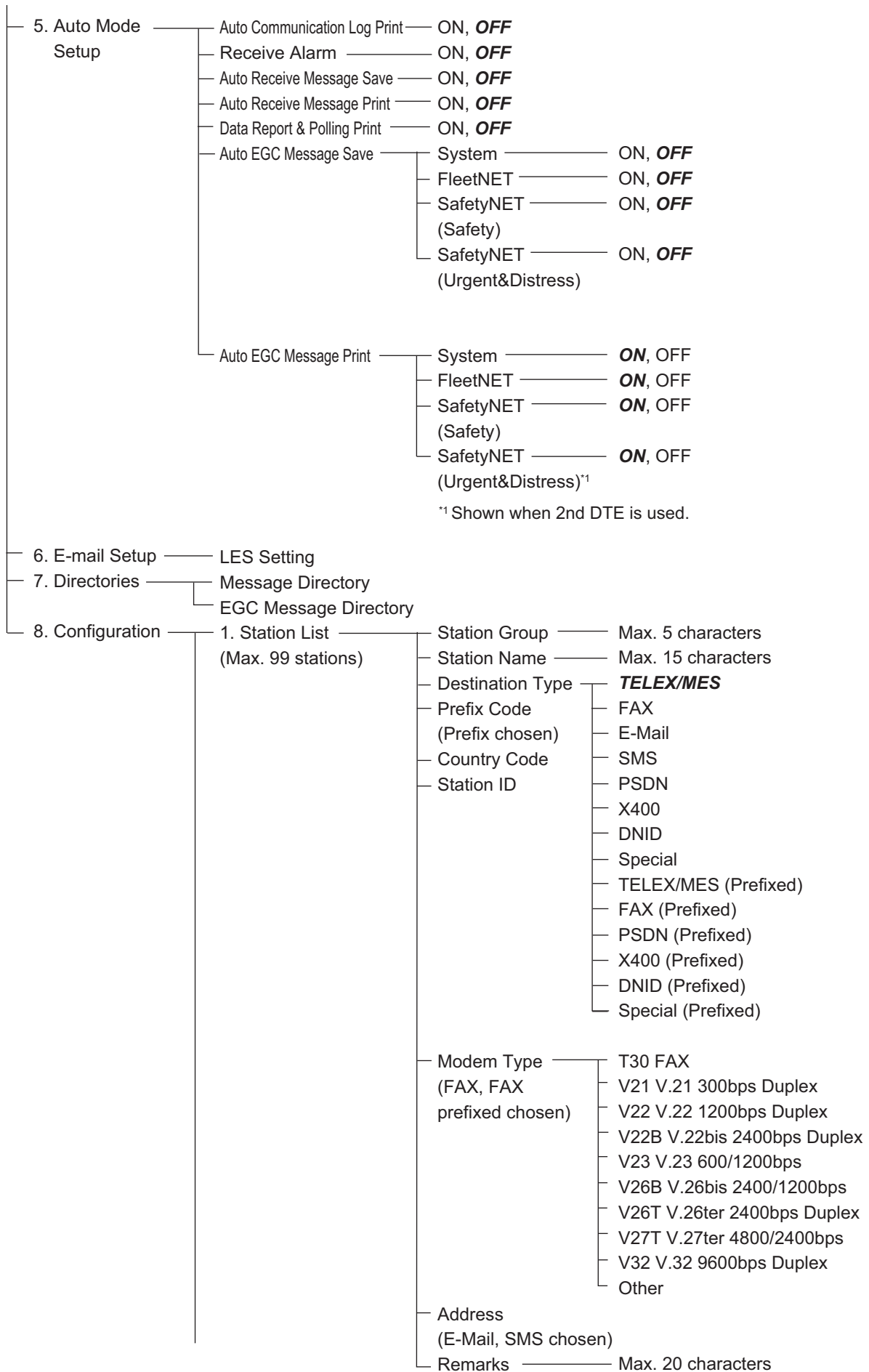

APPX. 1 MENU TREE

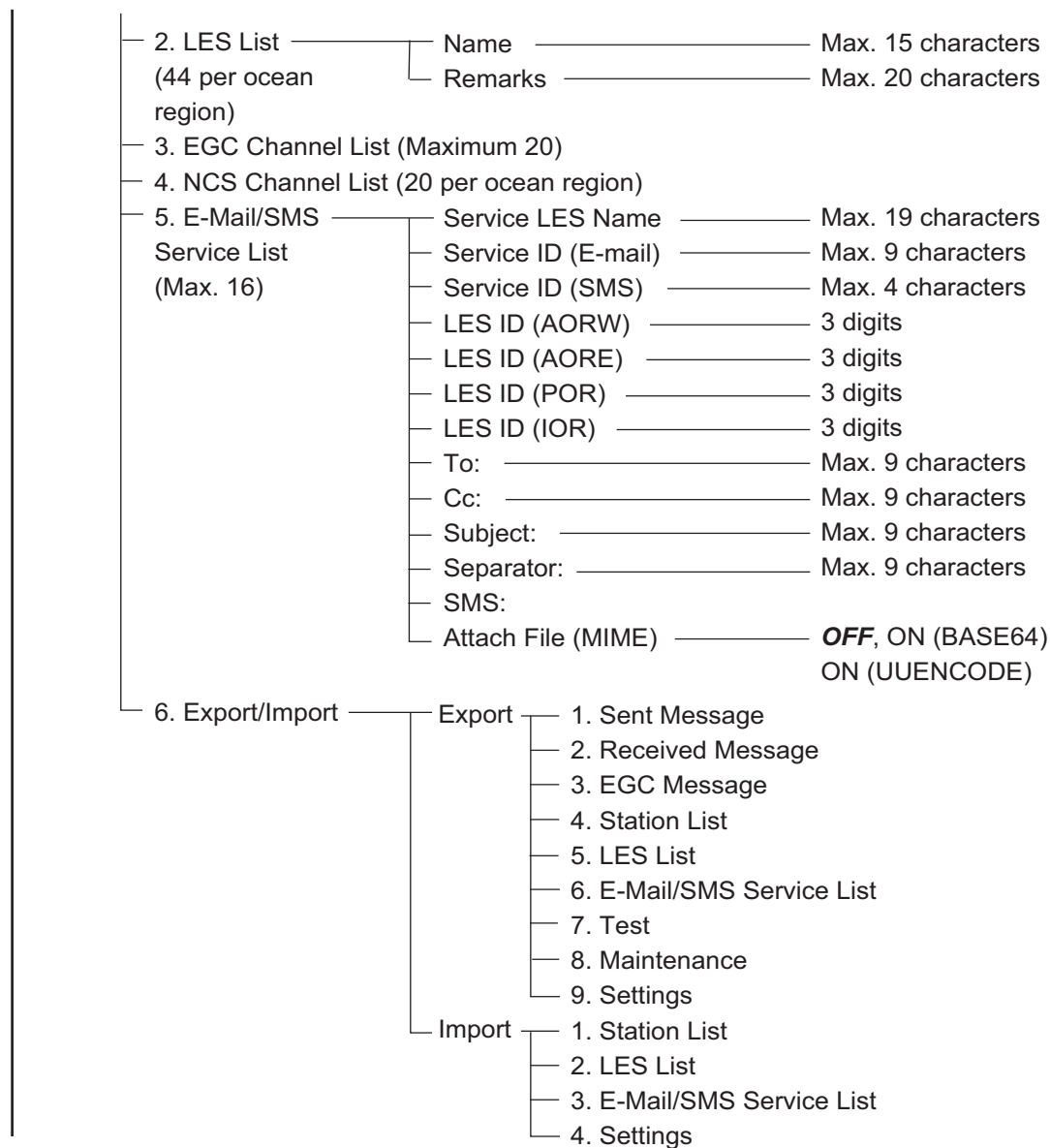

F9: Distress Alert Setup

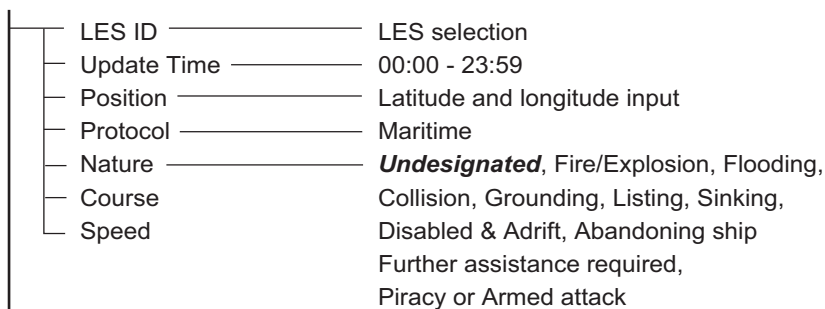

F10: Stop Alarm

APPX. 2 MESSAGES

Below are the various operational messages and their meanings. Messages are arranged according to function key.

Confirmation message

These messages appear in the confirmation window.

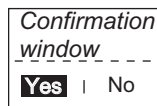

1. "Save this message?"
You are asked if you want to save a message.
2. "File already exists. Overwrite?"
You are asked if you are sure to overwrite file name entered.
3. "OK to delete file?"
You are asked if it is OK to delete selected file.
4. "Start"
Start a process.
5. "Decode"
Start decoding (a message).
6. "Search Start?"
Start search (for text).
7. "Replace Start?"
Start replacing (text)
8. "Cancel"
Cancel a process.
9. "Update"
Update a setting.
10. "Remove this SD card."
Remove SD card.
11. "OK to Export?"
Start exporting (data).
12. "OK to Import?"
Start importing (data).
13. "Connect"
Connect FELCOM
14. "Different network address. Show available network settings."
Show available IP addresses (to connect FELCOM)
15. "Format start."
Start formatting of SD card.
16. "Restore to default LES List."
Restore the default LES list.
17. "Restore to default E-Mail/SMS Service List."
Restore the default E-Mail/SMS Service list.

F1: File

1. "Can't delete."
Cannot delete selected file.
2. "Now saving"
File is being saved.
3. "Enter new file name"
Enter new file name.
4. "Can't rename."
Cannot rename selected file.
5. "Press any key to escape."
Press any key to erase displayed screen.)
6. "Drive not ready."
SD card not set in card slot.
7. "Write protected."
SD card is write protected.
8. "Drive error"
Trouble with SD card.
9. "Checking"
Checking MIME.
10. "Now decoding..."
11. "Completed."
Save/MIME completed.
12. "Decode failed."
MIME decoding failed.
13. "This terminal does not support this code."
You attempted to decode a file not supported by the terminal.
14. "Decoded % file(s)."
Decoding MIME-coded file.
15. "This file is not encoding."
You selected a file that has not been coded.
16. "Directory not found."
You specified a folder that does not exist.

F3: Transmit

1. "Input Error: Message File."
Invalid message selected for transmission.
2. "Input Error: Country/Ocean Code."
Invalid country/ocean code entered.
3. "Input Error: Destination."
Invalid station ID entered.
4. "Input Error: Modem Type."
Invalid mode type entered. (For FAX, select T30.)
5. "Input Error: E-Mail Address."
Invalid e-mail address entered.
6. "Input Error: LES ID."
Invalid LES ID entered.
7. "Input Error: Send Delay."
Invalid send delay time entered.
8. "Input Error: Prefix Code."
Invalid prefix code entered.

9. "Invalid character detected in message."

Invalid character found in TX message.

10. "Don't support E-Mail service in this NCS."

Selected NCS does not handle e-mail.

11. "Input Error: Too many stations."

You have selected too many stations to transmit to.

12. "Message file is too large (but enable to send)."

The size of the file you want to send is larger than 32,000 bytes. (The file can be sent, but only the first 32,000 bytes of information will be received.)

13. "Attach file is too large."

The size of the attachment you want to send is larger than 32,000 bytes.

14. "Attach file (file name) is not found."

Cannot find attached file.

15. "Message is entered in sending Queue. Press any key."

TX message entered into queue.

16. "Can't enter this message to sending Queue. Press any key."

Could not enter TX message into queue.

F5: Data report

1. "Input Error: Country/Ocean Code."

Invalid country/ocean code entered.

2. "Input Error: Destination."

Invalid station ID entered.

3. "Input Error: LES ID."

Invalid LES ID entered.

4. "Input Error: Interval Time"

Invalid interval time entered.

5. "Input Error: Start Time"

Invalid start time entered.

6. "Input Error: Modem Type"

Invalid modem type entered.

7. "Input Error: Report Contents"

Invalid report contents entered.

8. "Input Error: Report Times"

Invalid number of report times entered.

9. "Input Error: Destination"

Invalid destination entered.

10. "Input Error: E-Mail Address"

Invalid e-mail address entered.

11. "Don't support E-Mail service in this NCS."

NCS does not handle e-mail.

12. "Input Error: Prefix Code"

Invalid prefix code entered.

F7: Option

Login

1. "Successful Login".
Login completed successfully.
2. "Login failed".
Login failed.
3. "Login aborted."
Login aborted.
4. "MES Signaling Failure, Login Request not sent to NCS."
MES signaling failure, login request not completed.
5. "Timeout! Login Acknowledgement not received."
Login acknowledgement not received.
6. "Login failed because of RESTORATION mode Network."
You attempted to login when the restoration mode is active.

Logout

1. "Successful Logout".
Logout completed successfully.
2. "Logout failed".
Logout failed.
3. "Logout aborted."
Logout aborted.
4. "MES Signaling Failure, Logout Request not sent to NCS."
MES signaling failure, logout request not completed.
5. "Timeout! Logout Acknowledgement not received."
Logout acknowledgement not received.
6. "Logout failed because of RESTORATION mode Network."
You attempted to logout when the restoration mode is active.

APPX. 3 ABBREVIATIONS

Abbreviation	Meaning
AC/DC	Alternating Current/Direct Current
ACK	Acknowledge
ACQ	Acquire
Act	Active
Act-Unack	Active-Unacknowledged
AGC	Automatic Gain Control
AIS	Automatic Identification System
ALM	Almanac
ALT	Alternate Key
AMER	Atlantic Ocean West Satellite
AMS	Alert Management System
Ant	Antenna
AOR-E	Atlantic Ocean Region-East
AOR-W	Atlantic Ocean Region-West
AORE	Same as AOR-E
AORW	Same as AOR-W
APAC	Pacific Ocean Satellite
Apr	April
Ascii	American Standard Code for Information Interchange
ASCII	Same as Ascii
Aug	August
AUS	Australia
BAM	Bridge Alert Management
BBER	Bulletin Board Error Rate
bps	bits per second
C/N	Carrier to Noise ratio
Cate	Category
CAU.	Caution
CC	Common Channel
Ch.	Channel
Char.	Character
Col.	Column
COM, Comm.	Communication
CST	Cold Start
Ctrl	Control
dB	Decibel
DCE	Data Communication Equipment
Dec	December
DEG	Degree
DEL	Delete
DHCP	Dynamic Host Configuration Protocol
Dir	Directory
Disp.	Display
DND, DNID	Data Network Identity Number
DR	Data Report

APPX. 3 ABBREVIATIONS

Abbreviation	Meaning
DTE	Data Terminal Equipment
E	East
EDR	Enhanced Data Rate
EEPROM	Electrically Erasable Programmable Read-Only Memory
EGC	Enhanced Group Call
EMEA	Indian Ocean Satellite
EML	E-mail
END, ENID	EGC Network Identity Number
EPADR	Enhanced Pre-Assigned Data Report
ESC	Escape
Eth	Ethernet
EUR	Euro (currency)
EXT	External
FAX	Facsimile (receiver)
Feb	February
Freq	Frequency
GLONASS, GNSS	Global Navigation Satellite System
GMDSS	Global Maritime Distress Safety System
GPS	Global Positioning System
h, hrs	Hour(s)
Hz	Hertz
IA5	International Alphabet No. 5
ID	Identification
IMN	Inmarsat Maritime Number
IMO	International Maritime Organization
IMP	Impossible
INF	Information
INT	Internal, Interrupted
IOR	Indian Ocean Region
IP	Internet Protocol
ITA2	International Telegraph Alphabet No. 2
Jan	January
Jul	July
Jun	June
KB, KByte	Kilobyte
KDDI	Kokusai Denshin Denwa International
kn	Knot, Knots
L/L	Latitude/Longitude
L	Left
L-BLUE	Light Blue
L-CYAN	Light Cyan
L-GREEN	Light Green
L-MAGENTA	Light Magenta
L-RED	Light Red
L-WHITE	Light White
LAN	Local Area Network
LAT	Latitude
LED	Light Emitting Diode
LES	Land Earth Station

Abbreviation	Meaning
LON	Longitude
LORAN	Long-Range Navigation
LRIT	Long Range Identification and Tracking
MAN	Manual, Manual Input
Mar	March
May	May
MES	Mobile Earth Station
Meteo.	Meteorological
MIME	Multipurpose Internet Mail Extensions
min.	Minute(s)
Msg	Message
MSI	Maritime Safety Information
N	North
NAV	Navigation
NCS	Network Coordination Station
NAVTEX	Navigational Telex
NED	Netherlands
NG	No Good
No.	Number
NOR	Norway
Nov	November
OCC	Operation Control Center
Num	Number
Oct	October
Op.	Operation
PADR	Pre-Assigned Data Report
PIN	Personal Identification Number
POLL	Polling
POP3	Post Office Protocol 3
POR	Pacific Ocean Region
Pos.	Position
Pri	Priority
PSD, PSDN	Public Switched Data Network
PSTN	Public Switched Telephone Network
PV	Performance Verification
QRU	Q code message: "Have you anything for me?"/"I have nothing for you."
R	Right, Receive
RAM	Random Access Memory
RCV	Received
REC.	Receive, Received
Rec-Unack	Received-Unacknowledged
REF	Reference
REQ	Request
ROM	Read-Only Memory
Rx	Receive
S	South, Send
s, sec	second
SATNAV	Satellite Navigation System

APPX. 3 ABBREVIATIONS

Abbreviation	Meaning
SCC	Satellite Control Center
SD	Secure Digital (card)
SDHC	Secure Digital High Capacity
SEA INF	Sea Information
Sep	September
Seq.	Sequential
Sig.	Signal, Signaling
SPEC	Special
S.S.	Space Systems
SMS	Short Message Service
SMTP	Simple Mail Transfer Protocol
SSAS	Ship Security Alert System
St	Status
Std	Standard
STP	Stop
Subaddr	Sub Address
Sync	Synchronize, Synchronized
Synthe	Synthesizer
Sz	Size
T30FAX	T.30 Fax
TCXO	Temperature Compensated Crystal Oscillator
TDM	Time Division Multiplexing
TELEX	Teletype Exchange Service
TERM	Terminal
TLX	Telex
Tx	Transmit (send)
UNSYNC	Unsynchronized
USA	United States of America
USB	Universal Serial Bus
UTC	Universal Time Coordinate
UUENCODE	Unix-to-Unix encode
V.	Version
W	West
WAR.	Warning
WGS84	World Geodetic System 1984

APPX. 4 INTERNATIONAL TELEX/ TEL. COUNTRY CODE LIST, LES LIST

International Telex/Telephone Country Code List

Area and Country	Telephone Country Code	Telex Country Code	Remarks for Telex Code
Afghanistan	93	79	
Alaska	1	200	
Albania	355	604	
Algeria	21	408	
American Samoa	684	770	
American Virgin Is.	1	208	Telex calls to former WUI subscribers, insert the figure "9" after the destination code "208".
Andorra	33	590	
Angola	244	991	
Anguilla	1	391	
Antigua & Barbuda	2	393	
Argentina	54	33	Disregard the figure "0" at head of subscriber number.
Armenia	7	684	
Aruba	297	303	Subscriber numbers are 2XXX or 5XXX
Ascension	247	939	Manual calls 3XXX
Australia	61	71	
Australian External Territories	672	766	
Austria	43	47	
Azerbaijani	994	784	
Azores Is.	351	404	Destination code is the same as for Portugal.
Bahamas	1	297	
Bahrain	973	490	
Bangladesh	880	780	
Barbados	1	392	
Belarus	7	681	
Belgium	32	46	
Belize	501	371	
Benin	229	972	
Bermuda	1	290	
Bhutan	975	890	
Bolivia (Rep. of)	591	371	
Bolivia (ENTAL)		309	
Bosnia-Herzegovina	387	600	
Botswana	267	962	
Brazil	55	38	Disregard the figure "0" at head of subscriber number.
British Virgin Is.	1	292	
Brunei Darussalam	673	809	
Bulgaria	359	67	
Burkina Faso	226	978	
Burundi	257	903	

APPX. 4 INTERNATIONAL TELEX/TEL. COUNTRY CODE LIST, LES LIST

Area and Country	Telephone Country Code	Telex Country Code	Remarks for Telex Code
Cambodia	855	807	Kampuchea Rep.
Cameroon	237	970	
Canada	1	{ 21 26	Disregard the figure "0" at head of subscriber number.
Canary Is.	34	52	Destination code is the same as for Spain.
Cape Verde	238	993	
Cayman Is.	1	293	
Central Africa Rep.	236	971	
Chad	235	976	
Chile	56	34	{ TCH subscribers 2XXXXX ENTEL subscribers 5XXXXX TRA subscribers 3XXXXX TECOM subscribers 6XXXXX VTR CM subscribers 4XXXXX
China	86	85	
Christmas Is. (Aus)	672	766	
CIS (formerly USSR)	7	64	
Cocos-Keeling Is.	672	766	
Colombia	57	35	Disregard the figure "0" at head of subscriber number.
Comoros	269	994	Manual calls
Congo	242	981	
Cook Is.	682	772	
Costa Rica	506	376	
Cote d'Ivoire	225	983	Ivory Coast
Croatia	385	599	
Cuba	53	28	
Cyprus	357	605	
Czechoslovakia	42	66	
Denmark	45	55	
Diego Garcia	246	938	
Djibouti	253	979	
Dominica	1	394	
Dominican Rep.	1	{ 201 202 241	RCA subscribers 4XXXXX For subscriber number beginning with 346, disregard "346" at head of subscriber number. AGEM IR subscribers 61XX
Ecuador	593	308	
Egypt	20	91	
El Salvador	503	373	
Estonia (formerly USSR)	372	537	
Ethiopia	251	980	

APPX. 4 INTERNATIONAL TELEX/TEL. COUNTRY CODE LIST, LES LIST

Area and Country	Telephone Country Code	Telex Country Code	Remarks for Telex Code	
Falkland Is. (Malvinas)	500	306		
Faroe Is.	298	502		
Fiji	679	701		
Finland	358	57		
France	33	42		
French Guiana	594	300		
French Polynesia	689	702		
Gabon	241	973		
Gambia	220	996		
Georgia	7	683		
Germany (Fed. Rep. of)	49	69		
	49		41	
Ghana	233	94		
Gibraltar	350	405		
Greece	30	601		
Greenland	299	503		
Grenada	1	395		
Guadeloupe	590	299		
Guam (RCA)	671	700		
Guatemala	502	372		
Guiana	594	300		
Guinea Conakry	224	995	Manual calls	
Guinea Bissau	245	969		
Guyana	592	295		
Haiti	509	203	RCA subscribers 9XXX	
Hawaii	1	704	RCA subscribers 8XXX or 2968XX	
			705	ITT subscribers 743XXX
			708	WUI subscribers 63XXX or 63XXXX
			709	WUH subscribers 39XXXX
			(773)	Telex calls to HTC subscribers can be made using Semi-automatic calls.
Honduras	504	374		
Hong Kong	852	802		
Hungary	36	61		
Iceland	354	501		
India	91	81		
Indonesia	62	73	Disregard the figure "0" at head of subscriber number.	
Iran	98	88		
Iraq	964	491		
Ireland	353	500		
Israel	972	606	Disregard the figure "0" at head of subscriber number.	
Italy	39	43		

APPX. 4 INTERNATIONAL TELEX/TEL. COUNTRY CODE LIST, LES LIST

Area and Country	Telephone Country Code	Telex Country Code	Remarks for Telex Code
Jamaica	1	291	
Japan		72	KDDI (for 5 digits)
	81		NTT
Jordan	962	493	
Kazakhstan	7	785	
Kenya	254	987	
Kiribati	686	761	Subscriber numbers are 770XX
Korea (Demo, People's Rep. of)	850	(899)	
Korea (Rep. of)	82	801	
Kuwait	965	496	
Kyrgyzstan	7	788	
Lao	856	804	
Latvia (formerly USSR)	371	538	
Lebanon	961	494	
Lesotho	266	963	
Liberia	231	997	
Libya	21	901	
Liechtenstein	41	45	
Lithuania (formerly USSR)	370	539	
Luxembourg	352	402	
Macao	853	808	
Macedonia	389	597	
Madagascar	261	986	Subscriber number beginning with 4, 5, 7, 8 and 9 can be reached by Manual Calls.
Madeira Is.	351	404	Destination code is the same as for Portugal.
Malawi	265	904	
Malaysia	60	84	
Maldives Is.	960	896	
Mali	223	985	
Malta	356	{ 406 403	Subscriber number beginning with 11XX can be reached by Semi-automatic calls.
Mariana Is.	671	760	
Marshall Is.	692	765	
Maritinique	596	298	
Mauritania	222	974	
Mauritius	230	966	
Mexico	52	22	Disregard the figure "0" at head of subscriber number.
Micronesia	691	764	
Moldova	373	682	
Monaco	33	42	Destination code is the same as for France.
Mongolia	976	800	

APPX. 4 INTERNATIONAL TELEX/TEL. COUNTRY CODE LIST, LES LIST

Area and Country	Telephone Country Code	Telex Country Code	Remarks for Telex Code
Montserrat	1	396	
Morocco	21	407	
Mozambique	258	992	
Myanmar (formerly Burma)	95	83	
Namibia	264	908	
Nauru	674	775	
Nepal	977	891	
Netherlands	31	44	
Netherlands Antilles	599	390	
New Caledonia	687	706	
New Zealand	64	74	
Nicaragua	505	375	
Niger	227	975	2XXXX other numbers are for Semi-automatic calls.
Nigeria	234	905	
Niue Is.	683	776	
Northern Mariana Is.	670		
Norfolk Is.	672	766	
Norway	47	56	
Oman	968	498	
Pakistan	92	82	
Palau	680	763	
Panama	507	377	TRT subscribers
		378	AACR subscribers
		379	INTEL subscribers
Papua New Guinea	675	703	
Paraguay	595	305	
Peru	51	36	
Philippines	63	75	PHILCOM subscribers 2XXXX
			RCPI subscribers 7XXXX
			GMCR subscribers 4XXXX
			ETPI subscribers 6XXXX
			CAPWIRE subscribers 1XXXX
			For PTT subscribers, insert the figure "8" after the destination code "75".
Poland	48	63	Disregard the figure "0" at head of subscriber number.
Portugal	351	404	
Puerto Rico	1	205	RCA subscribers 2XXX
		206	ITT subscribers 345XXX
		207	C&W, WUI subscribers
		209	ACPR (PRCA) subscribers
Qatar	974	497	

APPX. 4 INTERNATIONAL TELEX/TEL. COUNTRY CODE LIST, LES LIST

Area and Country	Telephone Country Code	Telex Country Code	Remarks for Telex Code	
Reunion	262	961	Subscriber numbers are 916XXX	
Romania	40	65	Disregard the figure "0" at head of subscriber number.	
Russian Federation	7	64		
Rwanda	250	909		
Saipan	670	760		
San Marino	378	505	Manual calls	
Sao Tome & Principe	239	967		
Saudi Arabia	966	495		
Senegal	221	906		
Seychelles	248	965		
Sierra Leone	232	998		
Singapore	65	87		
Slovak	42	66		
Slovenia	386	598		
Solomon Is.	677	778		
Somalia	252	900		
South Africa	27	95		Cape Town subscribers XXXXXX Bophuthatswana subscribers 08XXXX Transkei subscribers 09XXXX
Spain	34	52		
Spanish North Africa	34	52		
Sri Lanka	94	803		Manual calls 4XXX
St. Helena	290	(960)		
St. Kitts & Nevis	1	397		
St. Lucia	1	398		
St. Pierre & Miquelon	508	204		
St. Vincent & the Grenadines	1	399		
Sudan	249	984		
Suriname	597	304		
Swaziland	268	964		
Sweden	46	54		
Switzerland	41	45		
Syria	963	492		
Tajikistan	7	787		
Taiwan	886	769		
Tanzania	255	989		
Thailand	66	86		
Togo	228	977		
Tokelau	690	762		
Tonga	676	777		
Trinidad & Tobago	296	294		
Tunisia	21	409		
Turkey	90	607		
Turkmenistan	7	789		

APPX. 4 INTERNATIONAL TELEX/TEL. COUNTRY CODE LIST, LES LIST

Area and Country	Telephone Country Code	Telex Country Code	Remarks for Telex Code
Turks & Caicos Is.	1	296	
Tuvalu	688	774	
U. A. E.	971	893	
Abu Dhabi			2XXXX, 3XXXX, 5XXXX
Ajman			695XX
Dubai			4XXXX
Fujairah			8XXXX
Ras Al Khaimah			9XXXX
Sharjah			68XXX
Umm Al Qaiwain			697XX
Uganda	256	988	
Ukraine	7	680	
United Kingdom	44	51	
United Arab Emirates	971	893	
Upper Volta	226	978	Same as "Burkina Faso".
Uruguay	598	32	
Uzbekistan	7	786	
U. S. A.	1	23	{ CCI subscribers 7XXXXXX ITT subscribers 4XXXXX, 4XXXXXX, 4XXXXXXXXXX RCA subscribers 2XXXXX WUI subscribers 6XXXX, 6XXXXX, 6XXXXXX TRT subscribers 1XXXXX, 1XXXXXXXXXX FTCC subscribers 8XXXX, 8XXXXX GRPHNET subscribers 36XXXXX, 37XXXXX For WUT subscribers, insert the figure "0" after the destination code "23".
U. S. A. (Mainland)		23	
		25	Telex calls to TWX subscribers whose numbers do not contain "0" as the third figure of the 10 figure code can be made as Semi-automatic calls.
U. S. S. R. (Former)	7	640	Russian Federation
Vanuatu	678	771	
Vatican	379	504	
Venezuela	58	31	
Viet Nam	84	805	Subscriber number beginning with 561XXX can be made using manual calls
Wallis & Futuna Is.	681	707	
Western Samoa	685	779	
Yemen (Rep. of)	969	806	Formerly Yemen (P. D. Rep. of)
Yugoslavia (Former)	967	895	Formerly Yemen (Arab Rep.)

APPX. 4 INTERNATIONAL TELEX/TEL. COUNTRY CODE LIST, LES LIST

Area and Country	Telephone Country Code	Telex Country Code	Remarks for Telex Code
Zaire	243	982	Telex calls to places other than Kinshasa Subscriber beginning with 2XXXXX can be made as Semi-automatic calls
Zambia	260	902	
Zanzibar	259	990	
Zimbabwe	263	907	
Ocean Area	Telephone Ocean Region Access Code	Telex Ocean Region Access	Remarks
AOR-W	874	584	Atlantic Ocean-W
AOR-E	871	581	Atlantic Ocean-E
POR	872	582	Pacific Ocean
IOR	873	583	Indian Ocean

LES List

Land earth station operator	Country	AMER	AORE	APAC	EMEA
Inmarsat Solutions (Borum)	Netherlands	002	102	202	302
Inmarsat Solutions (Borum2)	Netherlands	012	112	212	312
KDDI	Japan	003	103	203	303
Marlink (Aussaguel)	France	021	121	221	321
Marlink (Eik)	Norway	004	104	204	304
Marsat (Nudol)	Russia	–	–	217	317
MCN (Beijing)	China	–	–	211	311
Southbury	USA	001	101	201	301
Telecom Italia	Italy	–	105	–	335
Vishipel (Haiphong)	Vietnam	–	–	230	–
VSNL (Pune)	India	–	–	206	306

APPX. 5 INTERNATIONAL TELEX AB- BREVIATIONS, INTERNATIONAL TE- LEGRAPHY ALPHABET

International Telex Abbreviations

Abbreviation	Meaning
ADV	Advise
ACK	Acknowledge
AGN	Again
BI(GS)	Good bye
BK	I cut off.
CFN	Confirm
COL	Collation
CRV	How do you receive?
DER	Out of order
DWN	Down
EEE	Error
FM	From
GA	Go ahead
MNS	Minutes
MOM	Wait(Waiting)
MUTI	Mutilated
NA	Correspondence to this subscriber is not admitted.
NC	No circuits
NCH	Subscriber's number has been changed.
NP	The called party is not or is no longer a subscriber.
NR	Indicate your call number.
OCC	Subscriber is engaged.
OK	Agreed
P(or O)	Stop your transmission.
PLS(PSE)	Please
PPR	Paper
P(RCD)	Received
RAP	I will call again
RD	Read
RE	Referring to
RPT	Repeat
SRY	Sorry
SVP	Please
TAX	What is the charge?
TEST MSG	Please send a test message.
THRU	You are in communication with telex position.
TKS(TNX)	Thanks
TLX	Telex

International Telegraphy Alphabet

No.	FIGURES	LETTERS	No.	FIGURES	LETTERS
1	—	A	17	1	Q
2	?	B	18	4	R
3	:	C	19	'	S
4	⊕*	D	20	5	T
5	3	E	21	7	U
6	□*	F	22	=	V
7	■*	G	23	2	W
8	▣*	H	24	/	X
9	8	I	25	6	Y
10	BELL*	J	26	+	Z
11	(K	27	CARRIAGE RETURN	
12)	L	28	LINE FEED	
13	.	M	29	LETTERS	
14	,	N	30	FIGURES	
15	9	O	31	SPACE	
16	0	P	32	BLANK	

* = Cannot be entered.

APPX. 6 DIGITAL INTERFACE

Serial Interface

Input sentences: BWC, BWR, DBT, DTM, GGA, GLL, GNS, GSA, MTW, RMA, RMB, RMC, VDO, VDR, VTG, WPL, ZDA

Data reception

Data is received in serial asynchronous form in accordance with the standard referenced in IEC 61162-1 Ed.5 2016-08. The following parameters are used:

Baud rate: 38,400 bps (VDO). The baud rate of all other sentences is 4800 bps.

Data bits: 8 (D7 = 0), Parity: none, Stop bits: 1

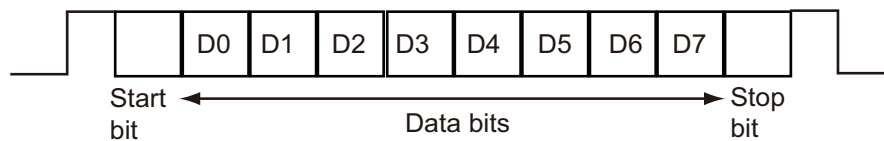

LAN Interface (IEC 61162-450, IEC 61162-1 Ed.5 compliant)

Input sentences: ACK, ACN, SRP

Output sentences: ALC, ALF, ALR, ARC, HBT, SM1*, SM2*, SM3*, SM4*, SMB*, SRP

* IEC61162-1 Ed.5

Data Sentences

Input sentences

ACK: Acknowledge alert

```
$**ACK,xxx*hh<CR><LF>
```

1. Local alarm number (identifier) (000 to 999)

ACN: Alert Command Message

```
$**ACN,hhmmss.ss,aaa,x.x,x.x,c,a*hh<CR><LF>
```

1. Time (UTC)
2. Manufacturer mnemonic code (3 digits)
3. Alert Identifier (0 - 999999)
4. Alert Instance (1 - 999999,null)
5. Alert command (A,Q,O,S)
 - A=acknowledge
 - Q=request/repeat information
 - O=responsibility transfer
 - S=silence
6. Sentence status flag (C) (fixed)

BWC: Bearing and distance to waypoint

\$ **BWC,hhmmss.ss,IIII.II, a,IIII.II,a,yyy.y,T, yyy.y,M,yyy.y,N,c--c,A*hh<CR><LF>
1 2 3 4 5 6 7 8 9 10 11 12 13

1. UTC of observation (000000.00 - 240001.00)
 2. Waypoint latitude (0.00000 - 9000.00000)
 3. N/S
 4. Waypoint longitude (0.00000 - 18000.00000)
 5. E/W
 6. Bearing, degrees true (0.00 - 360.00)
 7. Unit, True
 8. Bearing, degrees (0.00 - 360.00)
 9. Unit, Magnetic
 10. Distance, nautical miles (0.000 - 10000)
 11. Unit , N
 12. Waypoint ID (Max. 13 characters)
 13. Mode Indicator* (A=Autonomous D=Differential E= Estimated M=Manual S=Simulator)
- * Ver. 3.0 only

BWR: Bearing and distance to waypoint - rhumb line

\$ **BWR,hhmmss.ss,IIII.II,a,IIII.II,a,yyy.y,T,yyy.y,M,yyy.y,N,c--c,A*hh<CR><LF>
1 2 3 4 5 6 7 8 9 10 11 12 13

1. UTC of observation (000000.00 - 240001.00)
 2. Waypoint latitude (0.00000 - 9000.00000)
 3. N/S
 4. Waypoint longitude (0.00000 - 18000.00000)
 5. E/W
 6. Bearing, degrees true (0.00 - 360.00)
 7. Unit, True
 8. Bearing, degrees (0.00 - 360.00)
 9. Unit, Magnetic
 10. Distance, nautical miles (0.000 - 10000)
 11. Unit , N
 12. Waypoint ID (Max. 13 characters)
 13. Mode Indicator* (A=Autonomous D=Differential E= Estimated M=Manual S=Simulator)
- * Ver. 3.0 only

DBT: Depth below transducer

\$**DBT,xxxx.x,f,xxxx.x,M,xxxx.x,F*hh<CR><LF>
1 2 3 4 5 6

1. Water depth (0.00-99999.99)
2. Feet
3. Water depth (0.00-99999.99)
4. Meters
5. Water depth (0.00-99999.99)
6. Fathoms

DTM: Datum reference

```
$**DTM,ccc,a,x.x,a,x.x,a,x.x,ccc*hh<CR><LF>
  1 2 3 4 5 6 7 8
```

1. Local datum (W84=WGS84 W72=WGS72 S85=SGS85, P90=PE90
User defined=999, IHO datum code)
2. Local datum subdivision code (NULL or one character)
3. Lat offset, min (-59.99999 - 59.99999)
4. N/S
5. Lon offset, min (no use)
6. E/W
7. Altitude offset, meters (no use)
8. Reference datum (W84=WGS84 W72=WGS72 S85=SGS85, P90=PE90)

GGA: Global positioning system fix data

```
$**GGA,hhmmss.ss,lll.lll,a,yyyyy.yyy,a,x,xx,x.x,x.x,M,x.x,M,x.x,xxxx*hh<CR><LF>
  1 2 3 4 5 6 7 8 9 10 11 12 13 14
```

1. UTC of position (no use)
2. Latitude (0.00000 - 9000.00000)
3. N/S
4. Longitude (0.00000 - 18000.00000)
5. E/W
6. GPS quality indicator (1 -8)
7. Number of satellite in use (00 -12)
8. Horizontal dilution of precision (0.00 - 999.99), No use
9. Antenna altitude above/below mean sealevel (-999.99 - 9999.99), No use
10. Unit, m, No use
11. Geoidal separation (-999.99 - 9999.99), No use
12. Unit, m, No use
13. Age of differential GPS data (0 - 99), Ver. 2.0, 3.0 only
14. Differential reference station ID (0000-1023), Ver. 2.0, 3.0 only

GLL: Geographic position

```
$**GLL,lll.lll,a,yyyyy.yyy,a,hhmmss.ss,a,x*hh<CR><LF>
  1 2 3 4 5 6 7
```

1. Latitude (0.00000 - 9000.00000)
2. N/S
3. Longitude (0.00000 - 18000.00000)
4. E/W
5. UTC of position (no use), Ver 2.0, 3.0 only
6. Status (A=data valid V=data invalid), Ver 2.0, 3.0 only
7. Mode indicator* (A=Autonomous D=Differential E= Estimated M=Manual S=Simulator)
* Ver. 3.0 only)

GNS: GNSS fix data

\$**GNS,hhmmss.ss,llll.lll,a,lllll.lll,a,c--c,xx,x.x,x.x,x.x,x.x,x.x,a*hh<CR><LF>
 1 2 3 4 5 6 7 8 9 10 11 12 13

1. UTC of position (no use)
2. Latitude (0.00000 - 9000.00000)
3. N/S
4. Longitude (0.00000 - 18000.00000)
5. E/W
6. Mode indicator
 N=No fix A=Autonomous D=Differential P=Precise R=Real Time Kinematic
 F=Float RTK E=Estimated Mode M=Manual Input Mode S=Simulator Mode
7. Total number of satellites in use (00 - 99), No use
8. HDOP (0.0 - 999.99), No use
9. Antenna altitude, meters (-999.99 - 9999.99), No use
10. Geoidal separation (-999.99 - 9999.99), No use
11. Age of differential data (0 - 999), No use
12. Differential reference station ID (0000 - 1023), No use
13. Navigational status Indicator. No use

GSA: GNSS DOP and active satellites

\$**GSA,a,x,xx,xx,xx,xx,xx,xx,xx,xx,xx,xx,x.x,x.x,x.x,a*hh<CR><LF>
 1 2 3 4 5 6 7

1. Mode (M=manual, forced to operate in 2=2D 3=3D mode
 A=automatic, allowed to automatically switch 2D/3D)
2. Mode (1=fix not available 2=2D 3=3D)
3. ID number of satellites used in solution (01 - 96, NULL)
4. PDOP (0.00 - 999.99)
5. HDOP (0.00 - 999.99)
6. VDOP (0.00 - 999.99)
7. GNSS System ID

MTW: Water temperature

\$**MTW,x.x,C*hh<CR><LF>
 1 2

1. Water temperature (-9.999 - 99.999)
2. Degrees C

RMA: Recommended minimum specific Loran-C data

\$**RMA,A,llll.ll,a,yyyyy.yy,a,x.x,x.x,x.x,x.x,x.x,a*hh <CR><LF>
 1 2 3 4 5 6 7 8 9 10 11 12

1. Status: A=data valid, V=blink, cycle or SNR warning
2. Latitude, degrees (0.0000 - 9000.0000)
3. N/S
4. Longitude, degrees (0.0000 - 18000.0000)
5. E/W
6. Time difference A, microseconds (0.0 - 99999.9), No use
7. Time difference B, microseconds (0.0 - 99999.9), No use
8. Speed over ground, knots (0.0 - 9999.9)
9. Course over ground, degrees true (0.0 - 359.9)
10. Magnetic variation, degrees (0.0 - 180), No use
11. E/W
12. Mode indicator (A=Autonomous D=Differential mode E=Estimated (dead reckoning mode)
 M=Manual input mode S=Simulator N=Data not valid)

RMB: Recommended minimum specific navigation data

```
$**RMB,A,x.x,L,CCCC,CCCC,xxxx.xx,a,xxxxxx.xx,a,xxx.x,xxx,xx.x,A,a*hh <CR><LF>
      1 2 3 4 5 6 7 8 9 10 11 12 13 14
```

1. Data status (A=data valid, V=navigation receiver warning)
2. Cross track error (NM) (0.00 - 9.99), No use
3. Direction to steer (L/R), No use
4. Origin waypoint ID, No use
5. Destination waypoint ID, No use
6. Destination waypoint latitude (0.0000 - 9000.000)
7. N/S
8. Destination waypoint longitude (0.0000 - 18000.000)
9. E/W
10. Range to destination, nautical miles (0.000 - 10000), No use
11. Bearing to destination, degrees true (0.0 - 359.9), No use
12. Destination closing velocity, knots (-99.9 - 99.9), No use
13. Arrival status (A=Arrival circle entered or perpendicular passed, V=not entered/passed), No use
14. Mode indicator (A=Autonomous D=Differential mode E=Estimated (dead reckoning mode)
M=Manual input mode S=Simulator N=Data not valid)

RMC: Recommended minimum specific GNSS data

```
$**RMC,hhmmss.ss,A,llll.ll,a,yyyy.yy,a,x.x,x.x,ddmmyy,x.x,a,a,a*hh<CR><LF>
      1 2 3 4 5 6 7 8 9 10 11 12 13
```

1. UTC of position fix (000000 - 235959)
2. Status (A=data valid, V=navigation receiver warning)
3. Latitude (0.0000 - 9000.0000)
4. N/S
5. Longitude (0.0000 - 18000.0000)
6. E/W
7. Speed over ground, knots (0.0 - 9999.9)
8. Course over ground, degrees true (0.0 - 359.0)
9. Date (010100 - 311299)
10. Magnetic variation, degrees E/W (0.0 - 180.0/NULL), No use
11. E/W
12. Mode indicator (A=Autonomous D=Differential mode E=Estimated (dead reckoning) mode)
M=Manual input mode S=Simulator N=Data not valid)
13. Navigational status indicator. No use

SRP: System function ID resolution protocol

```
\s:ccxxx*hh\$**SRP,x,hhhhhhhhhhh,c--c*hh<CR><LF>
      1 2 3 4
```

1. Reported SFI of the transmitter
2. Instance number for interface redundancy (i.e. number of physical port for identical SFI), null if interface redundancy not in use. The instance numbers shall be ordinal with no skipping (1, 2, 3,...).
3. Reported MAC address used by SFI, 48bit hexadecimal number, for example, 32613C4EB605.
4. Reported IP address used by SFI as text string, for example, 239.192.0.1.

VDO: UAIS VHF data-link own-vessel report

! **VDO,x,x,x,x,s--s,x*hh<CR><LF>
1 2 3 4 5 6

1. Total number of sentences needed to transfer the message (1 to 9)
2. Message sentence number (1 to 9)
3. Sequential message identifier (0 to 9, NULL)
4. AIS channel Number (A or B)
5. Encapsulated ITU-R M.1371 radio message (1 - 63 bytes)
6. Number of fill-bits (0 to 5)

VDR: Set and drift

\$ **VDR,x.x,T,x.x,M,x.x,N*hh <CR><LF>
1 2 3 4 5 6

1. Direction, degrees (0.0 - 360.0)
2. T=True (fixed)
3. Direction, degrees (0.0 - 360.0)
4. M=Magnetic (fixed)
5. Current speed (0 - 99.99)
6. N=Knots (fixed)

VTG: Course over ground and ground speed

\$ **VTG,x.x,T,x.x,M,x.x,N,x.x,K,a*hh <CR><LF>
1 2 3 4 5 6 7 8 9

1. Course over ground, degrees (0.0 - 359.9)
2. T=True (fixed)
3. Course over ground, degrees (0.0 - 359.9)
4. M=Magnetic (fixed)
5. Speed over ground, knots (0.00-9999.9)
6. N=Knots (fixed)
7. Speed over ground (0.00 - 9999.9)
8. K=km/h (fixed)
9. Mode indicator (A=Autonomous, D=Differential E = Estimated (dead reckoning)
M=Manual input S=Simulator N=Data not valid)

WPL: Waypoint location

\$ **WPL,IIII.II,a,yyyyy.yy,a,c--c*hh<CR><LF>
1 2 3 4 5

1. Waypoint latitude (0.000000 - 9000.00000)
2. N/S
3. Waypoint longitude (0.00000 - 18000.00000)
4. E/W
5. Waypoint identifier (No use)

ZDA: Time and date

\$ **ZDA,hhmmss.ss,xx,xx,xxxx,xx,xx*hh<CR><LF>
1 2 3 4 5 6

1. UTC (000000.00 - 240001.00)
2. Day (01 - 31)
3. Month (01 -12)
4. Year (UTC, 0000 - 9999)
5. Local zone, hours (-13 to ±13), No use
6. Local zone, minutes (00 to ±59), No use

*Output sentences***ALC: Alert Cyclic list**

```
$**ALC,xx,xx,xx,x,x,aaa,x,x,x,x,x,*****hh<CR><LF>
  1 2 3 4 5 6 7 8 9
```

1. Total number of sentences this message (01 to 99)
2. Sentence number (01 to 99)
3. Sequential message identifier (00 to 99)
4. Number of alert entries (0 to 3)
5. Manufacturer mnemonic code (FEC, null)
6. Alert identifier (001 to 999999)
7. Alert instance (null)
8. Revision counter (1 to 99)
9. Additional alert entries (same as 5 and 8)

ALF: Alert sentence

```
$**ALF,x,x,x,hhmmss.ss,a,a,a,aaa,x,x,x,x,x,x,c--c*hh<CR><LF>
  1 2 3 4 5 6 7 8 9 10 11 12 13
```

1. Total number of ALF sentences this message (1, 2)
2. Sentence number (1, 2)
3. Sequential message identifier (0 to 9)
4. Time of last change (hh=00 to 23, mm=00 to 59, ss.ss=00.00 to 60.99), null
5. Alert category (A=Alert category A, B=Alert category B, C=Alert category C), null
6. Alert priority (A=Alarm, W=Warning, C=Caution), null when #2 is 2.
7. Alert state (V=Not ACKed, S=Silence, A=ACKed, O/U=Resolved, Not ACKed, N=Normal state), null when #2 is 2.
8. Manufacturer mnemonic code (FEC, null)
9. Alert identifier (001 to 999999)
10. Alert instance (null)
11. Revision counter (1 to 99)
12. Escalation counter (0 to 9)
13. Alert text (max. 18 characters)

Alert ID	Priority	Category	Instance	First Text	Second Text
3122	Warning	A	1	Distress Msg RX	Incoming distress. Check Inmarsat display
3122	Warning	A	2	Distress RX	Incoming distress. Check Inmarsat display
3122	Warning	A	3	Urgency RX	Incoming urgency. Check Inmarsat display
3122	Warning	A	0	MSG Received	Not used
3115 *1	Warning	B	Not used	Impaired radio	ANT V failure. Contact to FU-RUNO Service.
3008 *1	Warning	B	Not used	Lost TX PWR	TX PWR failure. Contact to FU-RUNO Service.
3116	Caution	B	1	Impaired radio	EGC SYNC loss. Change EGC channel.
3116	Caution	B	2	Impaired radio	SYNC loss. Check the current Ocean Region.
3116	Caution	B	0	Impaired radio	Not used
3009	Caution	B	1	Lost DIST UNIT	Check the IC-305 connection.
3009	Caution	B	2	Lost ALARM UNIT	Check the IC-306 connection.

Alert ID	Priority	Category	Instance	First Text	Second Text
3009	Caution	B	3	Lost SSAS UNIT	Check the IC-307 connection.
3009	Caution	B	0	Lost ext unit	Not used
3013	Caution	B	Not used	Doubtful POSN	Update current ship position.
3016	Caution	B	1	Lost position	GPS error. Contact to FURUNO Service
3016	Caution	B	2	Lost position	Check the position-fixing equipment.
3016	Caution	B	3	Lost position	Check the NAV Port setting or equipment.
3016	Caution	B	4	Lost position	Update current position manually.
3016	Caution	B	0	Lost position	Not used
3079	Caution	B	Not used	PRINTER ERROR	Check the printer and paper supply.
630003	Caution	B	Not used	BBER OVER	BBER over 80%. Select NCS manually.
630010	Caution	B	Not used	INVALID MES ID	Contact to FURUNO Service.
630050	Caution	B	Not used	EEPROM ERROR	Contact to FURUNO Service.
630643	Caution	B	Not used	DISTRESS BUTTON	Contact to FURUNO Service.
630200	Caution	B	Not used	1ST LOCAL UNLOCK	Contact to FURUNO Service.
630201	Caution	B	Not used	2ND LOCAL UNLOCK	Contact to FURUNO Service.

*1 The transfer of responsibility is allowed.

ALR: Alarm sentence

```
$**ALR,Hhmmss.ss,xxx,A,A,c—c*hh<CR><LF>
      1      2 3 4 5
```

1. Time of alarm condition change, UTC (000000.00 to 240001.00)
2. Unique alarm number (identifier) at alarm source (000 to 999)
3. Alarm condition (A=threshold exceeded, V=not exceeded)
4. Alarm acknowledge state (A=acknowledged, V=not acknowledged)
5. Alarm description text (alphanumeric)

ARC: Alert command refused

```
$**ARC,hhmmss.ss,aaa,x,x,x,x,c*hh<CR><LF>
      1      2 3 4 5
```

1. Release time (000000 - 235959.99)
2. Manufacturer mnemonic code (FEC, NULL)
3. Alert identifier (001 - 999999)
4. Alert instance (NULL)
5. Refused Alert Command (A, Q, O, S)
 - A=acknowledge
 - Q=request/repeat information
 - O=responsibility transfer
 - S=silence

HBT: Heartbeat

\$**HBT,x.x,A,x*hh<CR><LF>

1 2 3

1. Configured repeat interval (1 to 999)
2. Equipment status (A=Normal V=System fail)
3. Sequential sequence identifier (0 to 9)

SM1: SafetyNet Message, All Ships/NavArea

\$**SM1,A,x.x,xxxxxx,xxx,x,x,xx,xx,xxxx,xx,xx,xx,xx,xx*hh<CR><LF>

1 2 3 4 5 6 7 8 9 10 11 12 13 14

1. MSI status field
2. Unique message number
3. Unique message sequence number assigned by LES originating the message
4. 3-digit numeric ID of LES originating the MSI message
5. Ocean region code
6. Priority code of the MSI message
7. 2-digit service code (fixed)
8. 2-digit presentation code (fixed)
9. Year of message reception (UTC)
10. Month of message reception (UTC)
11. Day of message reception (UTC)
12. Hour of message reception (UTC)
13. Minute of message reception (UTC)
14. 2-digit address code (fixed)

SM2: SafetyNet Message, Coastal Warning Area

\$**SM2,A,x.x,xxxxxx,xxx,x,x,xx,xx,xxxx,xx,xx,xx,xx,xx,a.a*hh<CR><LF>

1 2 3 4 5 6 7 8 9 10 11 12 13 14 15 16

1. MSI status field
2. Unique message number generated by the receiving EGC terminal
3. Unique message sequence number assigned by LES originating the message
4. 3-digit numeric ID of LES originating the MSI message
5. Ocean region code
6. Priority code of the MSI message
7. 2-digit service code (fixed)
8. 2-digit presentation code (fixed)
9. Year of message reception (UTC)
10. Month of message reception (UTC)
11. Day of message reception (UTC)
12. Hour of message reception (UTC)
13. Minute of message reception (UTC)
14. 2-digit address code (fixed)
15. Coastal warning area
16. Coastal warning subject indicator

SM3: SafetyNet Message, Circular Address

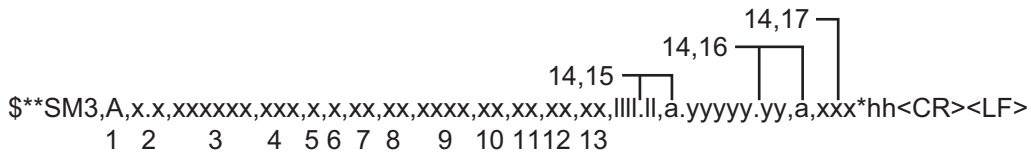

1. MSI status field
2. Unique message number generated by the receiving EGC terminal
3. Unique message sequence number assigned by LES originating the message
4. 3-digit numeric ID of LES originating the MSI message
5. Ocean region code
6. Priority code of the MSI message
7. 2-digit service code (fixed)
8. 2-digit presentation code (fixed)
9. Year of message reception (UTC)
10. Month of message reception (UTC)
11. Day of message reception (UTC)
12. Hour of message reception (UTC)
13. Minute of message reception (UTC)
- 14,15. Circular area address, center Latitude - N/S
- 14,16. Circular area address, center Longitude - E/W
- 14,17. Circular area address, radius in NM

SM4: SafetyNet Message, Rectangular Area Address

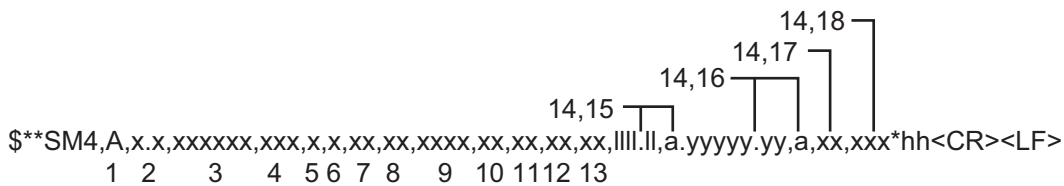

1. MSI status field
2. Unique message number generated by the receiving EGC terminal
3. Unique message sequence number assigned by LES originating the message
4. 3-digit numeric ID of LES originating the MSI message
5. Ocean region code
6. Priority code of the MSI message
7. 2-digit service code (fixed)
8. 2-digit presentation code (fixed)
9. Year of message reception (UTC)
10. Month of message reception (UTC)
11. Day of message reception (UTC)
12. Hour of message reception (UTC)
13. Minute of message reception (UTC)
- 14,15. Rectangular area address, South-West corner Latitude - N/S
- 14,16. Rectangular area address, South-West corner Longitude - E/W
- 14,17. Extent of rectangle area in Latitude degrees North
- 14,18. Extent of rectangle area in Latitude degrees East

SMB: IMO SafetyNet Message Body

\$**SMB,xxx.xxx,x,x.x,c---c*hh<CR><LF>
1 2 3 4 5

1. Total number of sentences needed to transfer the message, 001 to 999
2. Sentence number, 001 to 999
3. Sequential message identifier, 0 to 9
4. Unique message number
5. Message body

SRP: System function ID resolution protocol

See SRP in input section.

Proprietary sentences

PFEC rmset, PFEC rminf, PFEC rmalr.

APPX. 7 ALERT LIST AND CODES

Note: Alert priority for all AMS alert mode messages is set to “Warning”. The following table shows the alert priority for BAM alert mode.







AMS Alert ID	BAM Alert ID	Displayed Message	Priority	Category	Meaning(OM)	Measure(OM)
001	3116-1	EGC Synchronization loss. Please change EGC Channel.	Caution	B	Your station is not synchronized with selected EGC channel.	Change EGC channel.
002	3116-2	Synchronization loss. Please check the current Ocean Region. Scan another ocean region.	Caution	B	Your station is not synchronized with NCS common channel.	Check the current Ocean Region.
003	630003	BBER over 80%. Scanning NCS start manually.	Caution	B	BBER (Bulletin Board Error Rate) exceeded 80%.	BBER over 80%. Select NCS manually.
010	630010	The MES ID of this terminal is invalid, this equipment is defective. Please contact FURUNO Service.	Caution	B	MES ID is corrupted.	Have a licensed radiocommunications technician check the set.
050	630050	EEPROM ERROR. Have a licensed radio communications technician check the set.	Caution	B	Problem with EEPROM.	
100	3115	ANT power voltage abnormality. Have a licensed radio communications technician check the set.	AMS: Caution BAM: Warning	B	Antenna power voltage out of ratings.	
200	630200	1st Local UNLOCK. Have a licensed radio communications technician check the set.	Caution	B	1st local circuit is unlocked.	Have a licensed radiocommunications technician check the set.
201	630201	2nd Local UNLOCK. Have a licensed radio communications technician check the set.	Caution	B	2nd local circuit is unlocked.	
300	3008	TX Carrier power level abnormality. Have a licensed radio communications technician check the set.	AMS: Caution BAM: Warning	B	Carrier power level too high or too low.	
500	3122-1	Distress Msg RX. Incoming distress. Check Inmarsat display.	Warning	A	Distress EGC message received.	Check the contents of the message.
501	3122-2	Distress RX. Incoming distress. Check Inmarsat display.	Warning	A	Distress EGC message received.	
510	3122-3	Urgency RX Incoming urgency. Check Inmarsat display.	Warning	A	Urgent EGC message received.	

AMS Alert ID	BAM Alert ID	Displayed Message	Priority	Category	Meaning(OM)	Measure(OM)
630	3016-1	Internal GPS UNIT failure. If the condition often occurs, the internal GPS unit may be faulty. Have a qualified technician check the set.	Caution	B	Problem with the internal GPS unit.	Have a qualified technician check the set.
632	3016-2	External NAV equipment failure. Check the position-fixing equipment.	Caution	B	Problem with the external position-fixing equipment.	Check the position-fixing equipment.
-	3013	Manual position has not been updated within 4 hours, please update current position manually.	Caution	B	Position data is not current.	Update current ship position manually.
-	3016-3	Position data has not been received for more than 10 min. Check the NAV Port setting or position fixing equipment.	Caution	B	New position data has not been received from position fixing equipment for more than 10 minutes.	Check the NAV Port settings and check connection with position fixing equipment.
013	3016-4	Position data has not been updated within 4 hours, please update current position manually.	Caution	B	Position data is not current.	Update current ship position manually.
640	3009-1	DISTRESS ALERT UNIT Fault. Check that the unit is connected to this system.	Caution	B	Problem with the Distress Alert Unit (IC-305).	Check that the unit is connected to this system.
641	3009-2	ALARM UNIT connection abnormality. Check that the IC-306 is powered and connected to the FELCOM.	Caution	B	Problem with the Alarm Unit (IC-306).	Check that IC-306 is powered and connected to the FELCOM.
642	3009-3	SSAS UNIT connection abnormality. Check that the IC-307 is powered and connected to the FELCOM.	Caution	B	Problem with the SSAS Unit (IC-307).	Check that IC-307 is powered and connected to the FELCOM.
643	630643	DISTRESS Button abnormality. Have a licensed radio communications technician check the set.	Caution	B	Problem with the DISTRESS button.	Have a qualified technician check the set.
730	3079	Can't print. Printer not ready. (Offline / Paper Low) Check that the printer is powered and connected.	Caution	B	Cannot print.	Check that printer is powered and connected. Also check the paper supply.

BAM mode alert icons



The table below shows the icons that appear in the BAM mode.

Note: If more than one alert has occurred, the icon corresponding to the alert of highest priority is displayed.

Alert	Icon
Warning occurring (not confirmed in pop-up message)	 (flashing)
Warning occurring (buzzer stopped by BAM system)	 (flashing)
Warning occurring (confirmed in pop-up message)	
Warning occurring (Responsibility Transferred status)	
Warning resolved (not confirmed in pop-up message)	 (flashing)
Caution occurring	

Other icons

The following icons appear as indications for positioning integrity and validity.

Icon	Meaning
	Positioning data is invalid
	Positioning data is of low integrity

**SPECIFICATIONS OF INMARSAT-C MES
FELCOM 18**

1 GENERAL

1.1	Transmitting frequency	1626.5 to 1646.5 MHz
1.2	Receiving frequency	1537.0 to 1544.2 MHz
1.3	Channel interval	5 kHz
1.4	G/T	Better than -23 dB/K (elevation angle 5°)
1.5	EIRP	12 to 16 dBW (elevation angle 5°)
1.6	Modulation	BPSK
1.7	Modulation rate	600/1200 sps
1.8	Coding	Convolution with coding rate 1/2 and constraint length 7
1.9	Decoding	Viterbi decoder
1.10	EGC receiver	Built in (EGC: Enhanced Group Call)
1.11	LRIT function	Standard

2 ANTENNA UNIT

2.1	Antenna type	Daisy loop antenna
2.2	Receiving gain	33 to 40 dB
2.3	Receiving NF	1.7 dB or less
2.4	Transmitting gain	28.5 to 42.5 dB
2.5	Polarization	Right-hand circular polarization
2.6	Axial ratio	Within 6 dB (5° to 90°)
2.7	VSWR	2.0 or less (50 ohm)

3 TERMINAL UNIT

3.1	Display	10.4" color TFT LCD, 800 x 600 dots (SVGA)
3.2	Brilliance	11 steps
3.3	Visible distance	0.7 m nominal

4 INTERFACE

4.1	Number of port	
	Serial	I/O: 1 ch, Input: 1 ch, IEC61162-1
	Alarm (output)	1 ch, Contact closure, Normal close
	SSAS I/O	1 ch, RS-485, 1200 bps
	LAN	1 port, Ethernet 100Base-TX, RJ45 connector
	USB	1 port for keyboard, USB2.0
4.2	Data sentences	
	Serial	IEC61162-1 Ed.3/4/5
	Input	BWC, BWR, DBT, DTM, GGA, GLL, GNS, GSA, MTW, RMA, RMB, RMC, VDO, VDR, VTG, WPL, ZDA

- | | |
|------------------------------|--|
| Ethernet | IEC61162-450, IEC61162-1 Ed.5 |
| Input | ACK, ACN, SRP |
| Output | ALC, ALF, ALR, ARC, HBT, SM1/2/3/4, SMB, SRP |
| Datagram type | UdPbC |
| Output proprietary sentences | |
| PFEC | rminf, rmalr |
- 4.3 IEC61162-450 transmission group
- | | |
|--------|---------------------------------|
| Input | Arbitrary (default: MISC), NETA |
| Output | NETA, RCOM |
- 4.4 Other network functions (except IEC61162-450)
- DHCP, AutoIP, SMTP, POP3, PC terminal connect Protocol,
Furuno Management Protocol (FMP)

5 POWER SOURCE

- 5.1 Terminal unit 12-24 VDC: 8.0-4.0 A (Transmitting), 1.0-0.5 A (Receiving)
- 5.2 Printer (PP-520, option) 24VDC: 1 A max.
- 5.3 AC/DC power supply unit (option)
- | | |
|--------|---|
| PR-240 | 100-115/200-230 VAC, 1 phase, 50/60 Hz, 24 VDC from battery |
| PR-241 | 100-230 VAC, 1 phase, 50-60 Hz, 24 VDC from battery |

6 ENVIRONMENTAL CONDITION

- 6.1 Ambient temperature
- | | |
|--------------------|--|
| Antenna unit | -35°C to +55°C (storage: -35°C to +70°C) |
| Other indoor units | -15°C to +55°C |
- Note: Antenna unit is categorized as an outdoor installation equipment and other units are for indoor installation.
- 6.2 Relative humidity 95% or less at +40°C
- 6.3 Degree of protection
- | | |
|--|-------------------------------------|
| Antenna unit | IP56 |
| Terminal unit | IP20 (IP22: option) |
| Distress alert/received call unit/ SSAS alert unit | IP20 (IP22: option, bulkhead mount) |
| Alarm unit | IP22 |
| Junction box | IP20 (IP22: option, tabletop mount) |
| Printer/ Keyboard | IPX0 |
- 6.4 Vibration IEC 60945 Ed.4

7 UNIT COLOR

- 7.1 Antenna unit Upper: N9.5, Lower: 2.5PB3.5/10
- 7.2 Terminal unit/Junction box N2.5
- 7.3 Others 2.5GY5/1.5

INDEX

A

- AbbreviationsAP-13
- Abort..... 8-1
- Alarm Unit IC-306..... 2-5
- Alert messages 10-7
- Alert window..... 10-8
- Alerts 2-13
- Audio alarm 2-2

B

- Brightness 2-2

C

- Communication log
 - displaying 5-19
 - printing 5-19
- Country code listAP-17
- Current position log 10-6

D

- Data reporting
 - data report preparation..... 6-2
 - message report preparation 6-3
 - printing data report 6-4
 - printing polling command 6-4
- Data sentencesAP-27
- Digital interfaceAP-27

Directory

- creating 3-21
- specifying directory for message storage.....3-22

- Display indications 2-8

Distress Alert

- distress button test..... 7-5
- distress message preparation 7-4
- sending..... 7-1
- sending, nature of distress specified 7-2

- Distress Alert/Received Call Unit IC-305 .. 2-5

- DISTRESS button 2-1

- description 2-1
- testing of..... 7-5

- DNID 6-8

E

- Editor menu 4-3

EGC

- channel addition 3-13
- description 3-10
- displaying EGC messages 5-20
- EGC distress or urgent message 5-21
- EGC message log 5-22
- ENID..... 5-21
- message printing 3-14
- message saving 3-14
- printing EGC messages 5-20
- receiving channel 8-2
- settings..... 3-11

E-mail

- access restriction..... 9-7
- attachment conversion 9-8
- characteristics 9-2
- connecting FELCOM to shipboard LAN mail server 9-9
- decoding e-mail attachment 4-10
- DHCP setting..... 9-5
- e-mail client setup 9-11
- e-mail service/SMS station list 3-23
- gateway setting 9-6
- IP address 9-4
- outgoing message restriction 9-8
- overview 9-1
- PC connection for..... 9-3
- restrictions 9-1
- selective forwarding..... 9-10
- settings 3-24
- SMTP error messages 9-12
- subnet mask 9-4
- E-mail service/SMS station list..... 3-23
- E-mail settings..... 3-24
- EPADR..... 6-10
- Error messages 2-13
- Export system settings 3-25

F

Files

- changing name 4-9
 - combining 4-9
 - confidential 4-2
 - deleting 4-9
 - opening 4-7
 - printing 4-8
 - routine 4-1
 - saving 4-7
 - saving under new name 4-8
 - switching between 4-8
- Function keys 2-4
 - Fuse replacement 10-7

I

- Import system settings 3-25

- Inmarsat-C system overview 1-1

K

Keyboard

- description 2-2
- function keys 2-4
- shortcut keys 2-4

L

- LES information..... 8-3
- LES listAP-24
- editing..... 3-17
- printing 3-17

INDEX

- registering LES to.....3-16
- restoring default list.....3-17
- Login3-8
- Logout3-9
- LRIT
 - overview6-11
 - system.....6-12
- M**
- Maintenance
 - checking10-1
 - diagnostics10-2
- Menu overview2-12
- Menu treeAP-1
- MessagesAP-9
 - alert10-7
 - alert window10-8
 - warning.....10-9
- N**
- NCS channels
 - adding3-15
 - scanning.....8-1
 - selection of.....8-2
- P**
- Polling
 - commands.....6-5
 - PIN code registration.....6-5
 - reception6-7
- Position input3-20
- POWER switch2-1
- Printer2-6
- Printing
 - received messages, automatic.....5-18
- PV test
 - procedure10-3
 - results.....10-4
- R**
- Received message alarm5-16
- Receiving
 - deleting received messages.....5-19
 - displaying received message5-16
 - message.....5-15
 - printing received messages5-16
 - received message alarm5-16
 - saving received messages5-18
 - saving received messages automatically5-18
- S**
- SD card slot2-1
- SD cards4-6
- Sending
 - canceling transmission on message awaiting transmission5-10
 - delivery status, automatic request.....5-10
 - delivery status, manual request5-12
 - prepared message to station not on station list 5-6
 - prepared message to station on station list5-2
 - saved file5-9
- Sent message log5-14
- Shortcut keys2-4
- Standby display2-7
- Station list
 - adding station to.....3-17
 - editing.....3-20
 - printing3-20
- Sub terminal
 - installation of software.....2-13
 - printer selection.....2-16
 - start, quit application2-15
 - system backup2-16
- System configuration..... x
- System setup3-1
- System status monitor.....10-5
- T**
- Telegraphy alphabetAP-26
- Telex abbreviationsAP-25
- Terminal setup3-3
- Terminal unit
 - brightness of display2-2
 - cleaning10-1
 - description.....2-1
- Text
 - copying and pasting4-4
 - cutting and pasting4-4
 - go to line.....4-6
 - search and replace.....4-5
 - time or position insert4-6
- Transmitting
 - accessing 2-digit code service5-13
- U**
- USB port2-1
- W**
- Warning messages10-9

Declaration of Conformity



0575



0097

We **FURUNO ELECTRIC CO., LTD.**

(Manufacturer)

9-52 Ashihara-Cho, Nishinomiya City, 662-8580, Hyogo, Japan

(Address)

declare under our sole responsibility that the product

INMARSAT-C MES FELCOM18

(Serial No. 3598/4501/4502/4507/4508-xxxx)

(Model name, type number)

to which this declaration relates conforms to the following standard(s) or other normative document(s)

EU

Directive 2014/90/EU on Marine Equipment.
(MED) as amended the Implementing Regulation
(EU) 2024/1975

SOLAS 74 Reg. IV/7, IV/10, IV/14 & X/3
IMO Res. A.570(14), A.664(16), A.694(17),
A.807(19), MSC.36(63), MSC.97(73),
MSC.147(77), MSC.191 (79), MSC.263(84),
MSC.302(87), MSC.306(87), MSC.431(98),
MSC/Circ. 862, COMASR Circ. 32

(title and number of the requirements)

For assessment, see

- EC-type examination certificate (Module B)
222120006/AA/01 (MED/5.4),
222120009/AA/01 (MED/5.13);
Kiwa Nederland B.V. (0063)
- Product Quality System certificate (Module D)
MEDD00002CD Rev.6: DNV AS (0575)

On behalf of Furuno Electric Co., Ltd.

Nishinomiya City, Japan
4 September 2024

(Place and date of issue)

Akihiko Kanechika
Department General Manager
Quality Assurance Department

(name and signature or equivalent marking of authorized person)

PSTI Statement of Compliance

We **FURUNO ELECTRIC CO., LTD.**

(Name of manufacturer of the product)

9-52 Ashihara-Cho, Nishinomiya City, 662-8580, Hyogo, Japan

(Address of manufacturer of the product)

declare under our sole responsibility that the product

**INMARSAT-C MES
FELCOM18**

(Product type, batch)

December / 31 / 2025

(Support period for the product)

https://www.furuno.co.jp/en/csr/sociality/customer/product_security.html

(Weblink for latest information and contact to report to the manufacturer security issues)

to which this declaration relates conforms to the following standard(s) or other normative document(s)

Product Security and Telecommunications Infrastructure Act 2022
Product Security and Telecommunications Infrastructure (Security Requirements for
Relevant Connectable Products) Regulations 2023 Schedule 1

On behalf of Furuno Electric Co., Ltd.

Nishinomiya City, Japan
16 July 2024

(Place and date of issue)

Akihiko Kanechika
Department General Manager
Quality Assurance Department

(Signature, name and function of the signatory)