

# SAMYUNG ENC

## N560 / NF560 USER MANUAL







## Industry Canada

Operation is subject to the following two conditions: (1) this device may not cause interference, and (2) this device must accept any interference, including interference that may cause undesired operation of the device.

## FCC Statement

Note: This equipment has been tested and found to comply with the limits for a Class B digital device, pursuant to Part 15 of the FCC Rules. These limits are designed to provide reasonable protection against harmful interference in a normal installation. This equipment generates uses and can radiate radio frequency energy and, if not installed and used in accordance with the instructions, may cause harmful interference to radio communications. However, there is no guarantee that interference will not occur in a particular installation. If this equipment does cause harmful interference to radio or television reception, which can be determined by turning the equipment off and on, the user is encouraged to try to correct the interference by one or more of the following measures:

- 1- Reorient or relocate the receiving antenna
- 2- Increase the separation between the equipment and receiver
- 3- Connect the equipment into an output on a circuit different from that to which the receiver is connected
- 4- Consult the dealer or an experienced technician for help
- 5- A shielded cable must be used when connecting a peripheral to the serial ports

## Important

It is the owner's sole responsibility to install and use the unit in a manner that will not cause accidents, personal injury or property damage. The user of this product is solely responsible for observing safe boating practices.

**Global Positioning System:** The Global Positioning System (GPS) is operated by the US government which is solely responsible for its operation, accuracy and maintenance. The GPS system is subject to changes which could affect the accuracy and performance of all GPS equipment anywhere in the world.

**Installation:** If installation is not correct, the unit can not perform at its designed potential. If in doubt, consult your Samyung ENC dealer. Ensure that any holes made are in a safe position and will not weaken the boat's structure. If in doubt, consult a qualified boat builder.

SAMYUNG ENC DISCLAIMS ALL LIABILITY FOR ANY USE OF THIS PRODUCT IN A WAY THAT MAY CAUSE ACCIDENTS, DAMAGE OR THAT MAY VIOLATE THE LAW.

**Governing language:** This statement, any instruction manuals, user guides and other information relating to the product (documentation) may be translated to, or has been translated from, another language (translation). In the event of any conflict between any translations of the documentation, the English language version of the documentation will be the official version of the documentation. This manual represents the installation procedures as at the time of printing. Samyung ENC reserves the right to make changes to specifications without notice.

Copyright © 2009 Samyung ENC, Republic of Korea, all rights reserved.

## Presentation

Thank you for having purchased a Samyung ENC product. This handbook contains an explanation of how to install, operate and maintain your unit.

# SAFETY INSTRUCTIONS



Electronic charts displayed by the chart plotter are believed to be accurate and reliable, but they are not intended to replace official charts which should remain your main reference for all the matters related to the execution of a safe navigation. For this reason we would like to remind you that you are required to carry on board and use the officially published and approved nautical chart.

Please read through this manual before the first operation. If you have any questions, please contact the customer service or your local dealer or distributor. Extensive exposure to heat may result in damage to the chart plotter. Connection to the power source with reversed polarity will damage the chart plotter severely. This damage is not covered by the warranty. Do not disassemble. The chart plotter contains dangerous high voltage circuits which only experienced technicians must handle. Exposure of the display to UV rays may shorten the life of the liquid crystals used in your plotter. This limitation is due to the current technology of the LCD display. Avoid overheating which may cause loss of contrast and, in extreme case, a darkening of the screen. Problems which occur from over heating are reversible when temperature decreases.

## Screen Cleaning Precautions

Cleaning your chart plotter screen is a very important operation and must be done carefully. The following is the cleaning procedure. You use a tissue or lens tissue and a cleaning spray containing Isopropanol (a normal spray cleaner sold for PC screens). Fold the tissue or lens tissue into a triangular shape, moisten the tip and use the index finger behind a corner to move the tissue across the surface, in overlapping side to side strokes. If the tissue is too wet, a noticeable wet film will be left in its path and you will need to repeat the process. If too dry, the tissue won't glide easily, and may damage the surface.

If you require technical advice or assistance, contact your nearest Samyung ENC office or visit our website, [www.samyungenc.com](http://www.samyungenc.com).



# 1 Introduction











1-1 General Information .....	9
1-2 Specification.....	9
1-3 Packing List .....	11
1-4 Optional Accessories .....	11

# 2 Getting Started



2-1 Mounting the Unit.....	12
2-1-1 Bracket Mounting.....	12
2-1-2 Flush Mounting.....	12
2-2 Keys .....	13
2-3 C-MAP MAX Secure Digital (SD) Card .....	14
2-4 Chart Selection .....	14
2-5 Simulate Mode.....	14
2-6 Data Bar .....	15
2-7 Compass.....	16
2-8 Multi window displays .....	17
2-9 Man overboard (MOB).....	19







# 3 General Operation

3-1 Manual / Auto Power on and off.....	20
3-2 Brightness, night mode and Background .....	20
3-3 The page window .....	21
 3-4 Chart .....	23
3-4-1 Chart window .....	23
3-4-2 Perspective view .....	23
3-4-3 Latitude and longitude .....	24
3-4-4 Chart scale .....	24
3-4-5 Finding a chart symbol.....	24
3-4-6 S-Map search.....	25
3-4-7 Chart symbols and information.....	25
3-4-8 Introduction to navigating.....	25
3-4-9 Going to a waypoint or to a point on the chart .....	26
3-4-10 Following a route .....	26
3-4-11 Goto Key .....	26
3-4-12 Distance and bearing calculator.....	27
3-4-13 Projected course .....	27
 3-5 Sonar .....	28
3-5-1 Interpreting the display.....	28
3-5-2 Mode.....	28
3-5-3 Single and Dual frequency fish finding .....	29
3-5-4 Range .....	29
3-5-5 Gain .....	30
3-5-6 Sonar window display .....	31

	3-5-7 No split.....	31
	3-5-8 Split zoom and Full Screen zoom.....	32
	3-5-9 Split bottom.....	32
	3-5-10 Split 50/200.....	33
	3-5-11 Split A-Scope .....	33
	<b>3-6 Highway .....</b>	<b>34</b>
	<b>3-7 Gauges .....</b>	<b>34</b>
	<b>3-8 Waypoints.....</b>	<b>35</b>
	3-8-1 Creating a new waypoint .....	35
	3-8-2 Moving a waypoint.....	35
	3-8-3 Editing an existing waypoint.....	35
	3-8-4 Deleting a waypoint.....	36
	3-8-5 Find a waypoint .....	36
	3-8-6 Sort Waypoints .....	36
	3-8-7 Deleting all waypoints.....	36
	<b>3-9 Routes.....</b>	<b>37</b>
	3-9-1 Managing a route from the chart window .....	37
	3-9-2 Managing a route from the route window.....	38
	<b>3-10 Satellites .....</b>	<b>39</b>
	3-10-1 Satellite information.....	39
	<b>3-11 Tides.....</b>	<b>40</b>
	<b>3-12 AIS .....</b>	<b>41</b>
	3-12-1 Viewing AIS Vessels .....	41
	3-12-2 AIS Windows .....	41
	<b>3-13 DSC.....</b>	<b>43</b>
	3-13-1 distress.....	43
	3-13-2 Poll.....	44
	<b>3-14 NAVTEX.....</b>	<b>45</b>
	<b>3-15 Engine Faults.....</b>	<b>45</b>

## 4 Advance Settings

	<b>4-1 System Configuration Settings.....</b>	<b>46</b>
	4-1-1 Language .....	46
	4-1-2 Chart Selection .....	46
	4-1-3 Beep volume .....	46
	4-1-4 Auto power.....	46
	4-1-5 Features.....	46
	4-1-6 Factory reset .....	46
	4-1-7 About .....	46
	<b>4-2 Chart Settings.....</b>	<b>47</b>
	4-2-1 Rotation .....	47
	4-2-2 Palette.....	47
	4-2-3-1 General(C-MAP).....	47
	4-2-3-2 General(S-MAP).....	48
	4-2-4-1 Land & Sea (C-MAP).....	48

	4-2-4-2 Land & Sea (S-MAP) .....	48
	4-2-5 Map datum .....	48
	4-2-6 NMEA datum offset .....	49
	4-2-7 Map shift .....	49
	4-2-8 Restore default .....	49
	<b>4-3 Sonar Settings .....</b>	<b>50</b>
	4-3-1 Frequency .....	50
	4-3-2 Palette .....	50
	4-3-3 Scroll speed .....	50
	4-3-4 Digit size .....	50
	4-3-5 Fish .....	50
	4-3-6 Advance Settings .....	50
	4-3-7 Restore default .....	50
	<b>4-4 GPS Settings .....</b>	<b>51</b>
	4-4-1 GPS Source .....	51
	4-4-2 DGPS Source .....	51
	4-4-3 Static Navigation .....	51
	4-4-4 Speed Filter and Course Filter .....	51
	4-4-5 Lat/Lon d.p's .....	51
	4-4-6 Ship speed .....	51
	4-4-7 Magnetic Variation .....	51
	<b>4-5 Track &amp; Log Settings .....</b>	<b>52</b>
	4-5-1 Track .....	52
	4-5-2 Logs .....	52
	<b>4-6 Memory Settings .....</b>	<b>53</b>
	4-6-1 Save .....	53
	4-6-2 Load .....	53
	4-6-3 Delete .....	53
	4-6-4 Format .....	54
	4-6-5 Screen snap shot .....	54
	<b>4-7 AIS Settings .....</b>	<b>54</b>
	4-7-1 Display filter .....	54
	4-7-2 Alarm option .....	55
	4-7-3 Display options .....	55
	4-7-4 Restore default .....	55
	<b>4-8 Alarms .....</b>	<b>56</b>
	4-8-1 Fish .....	56
	4-8-2 Deep .....	56
	4-8-3 Shallow .....	56
	4-8-4 Temperature .....	56
	4-8-5 Temperature rate .....	56
	4-8-6 Low battery .....	56
	4-8-7 Navigation alarms .....	56
	4-8-8 AIS .....	56
	4-8-9 DGPS .....	56
	4-8-10 Restore default .....	56
	<b>4-9 Others .....</b>	<b>57</b>
	4-9-1 Simulate .....	57
	4-9-2 Waypoint .....	57
	4-9-3 GPS .....	57

4-9-4 Units .....	57
4-9-5 Comms.....	57
4-9-6 Calibrate.....	57
4-9-7 Time.....	57
4-9-8 Restore default .....	57
4-9-9 Calendar.....	57

## **5 INSTALLATION**

5-1 Options and Accessories.....	58
5-2 Connections .....	59
5-3 Power/data cable.....	59
5-4 Alarm .....	60
5-5 GPS antenna .....	61
5-5-1 Internal antenna.....	61
5-5-2 External antenna .....	61
5-5-3 The antenna using NMEA.....	61
5-6 NMEA 0183 .....	62
5-7 NMEA 2000 .....	63
5-8 Sonar Transducers .....	64
5-9 Setup and test.....	65



# 1 Introduction

## 1-1 General Information

The chart plotter is a precision-crafted GPS chart Plotter with high-performance receiver for the Global Positioning System constellation of satellites, providing precise location data with a host of navigation features. Some functions require optional units and sensors installed on your boat.

The chart plotter can be connected to external devices with NMEA0183 and NMEA2000 interface and display information. Following are the examples.

- NAVTEX
- AIS receiver
- DSC VHF radio
- Transducer & sensors
- Autopilot

## 1-2 Specification

### [N560]

GENERAL	
<b>Category</b>	<b>Detail</b>
<b>Size</b>	164 mm(H) x 183 mm(W) x 74 mm(D)
<b>Display</b>	5.6" diagonal, TFT color, 480 x 640 pixels.
<b>Supply voltage</b>	10 to 34 V DC
<b>Supply current</b>	13.8 V 350 mA min - no backlighting. 480 mA max - full backlighting.
<b>External beeper or light output</b>	Switched to ground to sound alarm, 30V DC, 200 mA maximum
<b>Operating temperature</b>	-10° to 50°C
ALARMS	
User set: Arrival radius, anchor, XTE, danger, low battery, loss of DGPS fix, dangerous AIS vessels.	
GPS NAVIGATION	
<b>Chart card</b>	C-MAP™ SD Card (NT-MAX, NT+ or NT)
<b>User card</b>	SD Card
<b>Waypoints</b>	Up to 10,000, with default or user defined alphanumeric names up to eight characters.
<b>Routes</b>	100 Routes, with up to 100 points each
<b>Tracks</b>	By time or distance, 10 track of 15,000 points
<b>Chart datums</b>	216 Chart datums, One user-defined map shift.
<b>Chart scale</b>	0.2 to 500 nm for chart (chart dependent) down to 0.005 nm in plotter mode.
COMMUNICATIONS	
<b>NMEA</b>	NMEA 0183 4800, 9600, 38400 baud, NMEA 2000
<b>NMEA 0183 Inputs from compatible instruments</b>	DBK, DBS, DBT, DPT, GGA, GLL, GNS, GGA, GSV, HDG, HDT, MDA, MTA, MTW, MWD, MWV, RMC, RPM, VHW, VTG, VWT, ZDA
<b>NMEA 2000 Inputs from compatible instruments</b>	System date and time(PGN126992),Vessel Heading(PGN127250),Engine parameters/Rapid Update(PGN127488), Engine parameters/Dynamic(PGN127489),Trip parameters/Engine(PGN127497),Engine parameters/Static(PGN127498),Fluid level(PGN127505),Water Speed(PGN128259),Water depth(PGN128267),Position/Rapid Update(PGN129025),COG & SOG/Rapid Update(PGN129026),GNSS Position Data(PGN129029),GNSS DOPs(PGN129539),GNSS Sats in View(PGN129540),Wind Data(PGN130306),Environmental Parameter-Water temp(PGN130310),Environmental Parameter(PGN130311)
<b>NMEA 0183 Outputs, for</b>	APA, APB, BWR, GGA, GLL, GSA, GSV, RMB, RMC, VTG, XTE, DBT,

<b>compatible instruments</b>	DPT, MTW, VHW, XDR
<b>NMEA 2000 Outputs, for compatible instruments</b>	Water Speed(128259), Water depth(128267), XTE(129283), NAV. data(129284), NAV. data(129285), COG & SOG(129026), GNSS position(129029), Water temp.(130310)

## [NF560]

<b>GENERAL</b>	
<b>Category</b>	<b>Detail</b>
<b>Size</b>	164 mm(H) x 183 mm(W) x 74 mm(D)
<b>Display</b>	5.6" diagonal, TFT color, 480 x 640 pixels.
<b>Supply voltage</b>	10 to 34 V DC
<b>Supply current</b>	13.8 V 800mA min - no backlighting. 1000mA max - full backlighting.
<b>External beeper or light output</b>	Switched to ground to sound alarm, 30V DC, 200 mA maximum
<b>Operating temperature</b>	-10° to 50°C
<b>ALARMS</b>	
User set: Arrival radius, anchor, XTE, danger, too shallow, too deep, fish, temperature, temperature rate, low battery, loss of DGPS fix, dangerous AIS vessels.	
<b>GPS NAVIGATION</b>	
<b>Chart card</b>	C-MAP™ SD Card (NT-MAX, NT+ or NT)
<b>User card</b>	SD Card
<b>Waypoints</b>	Up to 10,000, with default or user defined alphanumeric names up to eight characters.
<b>Routes</b>	100 Routes, with up to 100 points each
<b>Tracks</b>	By time or distance, 10 track of 15,000 points
<b>Chart datums</b>	216 Chart datums, One user-defined map shift.
<b>Chart scale</b>	0.2 to 500 nm for chart (chart dependent) down to 0.005 nm in plotter mode.
<b>COMMUNICATIONS</b>	
<b>NMEA</b>	NMEA 0183 4800, 9600, 38400 baud, NMEA 2000
<b>NMEA 0183 Inputs from compatible instruments</b>	DBK, DBS, DBT, DPT, GGA, GLL, GNS, GGA, GSV, HDG, HDT, MDA, MTA, MTW, MWD, MWV, RMC, RPM, VHW, VTG, VWT, ZDA
<b>NMEA 2000 Inputs from compatible instruments</b>	System date and time(PGN126992),Vessel Heading(PGN127250),Engine parameters/Rapid Update(PGN127488), Engine parameters/Dynamic(PGN127489),Trip parameters/Engine(PGN127497),Engine parameters/Static(PGN127498),Fluid level(PGN127505),Water Speed(PGN128259),Water depth(PGN128267),Position/Rapid Update(PGN129025),COG & SOG/Rapid Update(PGN129026),GNSS Position Data(PGN129029),GNSS DOPs(PGN129539),GNSS Sats in View(PGN129540),Wind Data(PGN130306),Environmental Parameter-Water temp(PGN130310),Environmental Parameter(PGN130311)
<b>NMEA 0183 Outputs, for compatible instruments</b>	APA, APB, BWR, GGA, GLL, GSA, GSV, RMB, RMC, VTG, XTE, DBT, DPT, MTW, VHW, XDR
<b>NMEA 2000 Outputs, for compatible instruments</b>	Water Speed(128259), Water depth(128267), XTE(129283), NAV. data(129284), NAV. data(129285), COG & SOG(129026), GNSS position(129029), Water temp.(130310)
<b>SONAR FISHFINDING</b>	
<b>Depth range</b>	0 m to 600 m
<b>Sonar output</b>	Power: Variable, up to 600 W RMS Dual frequency: 50 khz and 200 khz
<b>Temperature</b>	Range 0° to 37.7°C (32°F to 99.9°F) Resolution of 0.1° unit.
<b>Speed</b> (from paddlewheel transducer)	1 to 96.6 kph (57.5 mph, 50 kn).

## 1-3 Packing List

Item List	Part number	Model	
		N560	NF560
Display	N560-E	0	0
Bracket	N560-DB	0	0
Display Cover	N560-CC	0	0
Power Cable	LTW-1750-8 (N560) LTW-2000-8 (NF560)	0	0
Bracket mounting screw	N560-BP	0	0
Flush mount Kit (Including screw)	N560-TK	0	0
Protection Cover	N560-CB	0	0
User's Manual(Eng)	N560-ME	0	0
CD-ROM(Multi-language)	N560-MCD	0	0
Quick Reference (Multi-language)	N560-QSG	0	0
Cable tie	N560-CK	0	0
P58 Transducer	P58	X	0

## 1-4 Optional Accessories

Model	Part number	Item List
GPS Antenna + GPS Antenna Support	SAN-60-10	GPS antenna + BNC Plug
		GPS antenna support
		GPS antenna cable(10m)
GPS Antenna Stand type Support	57745	GPS Antenna Stand type Support
Y cable	NF560-YC	Y cable(see section 5-8)
B45 Transducer	B45	Option
P39 Transducer(NMEA 2000)	P39	Option(for only N560)

## 2 Getting Started

### 2-1 Mounting the Unit

The chart plotter is supplied with bracket and flush mounting kit. You can choose a method of installation according to your preference.

#### 2-1-1 Bracket Mounting

Before installing ensure the area the bracket is mounted to is strong enough to support the weight of the GPS chart plotter. After the location is found, attach the mounting base to the area using the supplied hardware.

##### Mounting the display unit:

- 1 Hold the display unit and find a groove joint between the display unit and bracket.
- 2 Gently push the display unit into the groove of bracket and turn the knob to clockwise to lock

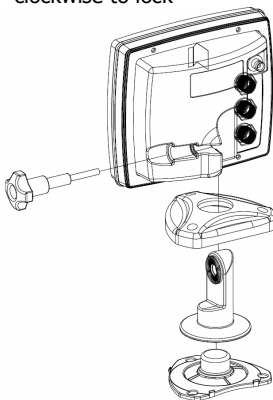

##### Removing the display unit:

- 1 Turn the unit off
- 2 Turn the knob to counter clockwise
- 3 Pull the display unit out.

##### **Note**

The chart plotter with internal GPS antenna is designed to be bracket mounting and flush mounting. However, if you flush mount inside of your boat, GPS performance can be reduced.

#### 2-1-2 Flush Mounting

- 1 Find a location for flush mounting.
- 2 Drill a hole in the area of the cutout area for the blade of jig saw.
- 3 insert and cut out the area on the panel using the jig saw
- 4 Drill four holes for mounting studs.
- 5 Install the mounting studs on the chart plotter and insert them into the mounting hole.
- 6 Attach the chart plotter to the mounting location by attaching the supplied hardware to the mounting studs.

##### **Note**

- 1 If you flush mount, you need the optional external GPS antenna.
- 2 Before Drilling holes make sure there is enough space to mount the chart plotter there is no obstructions.

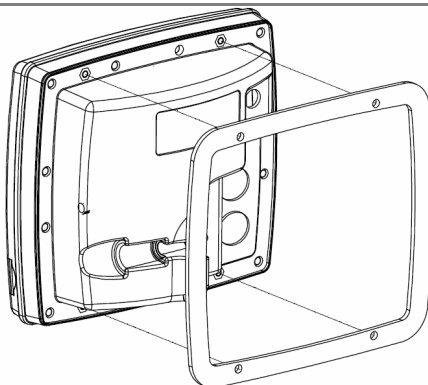

## 2-2 Keys

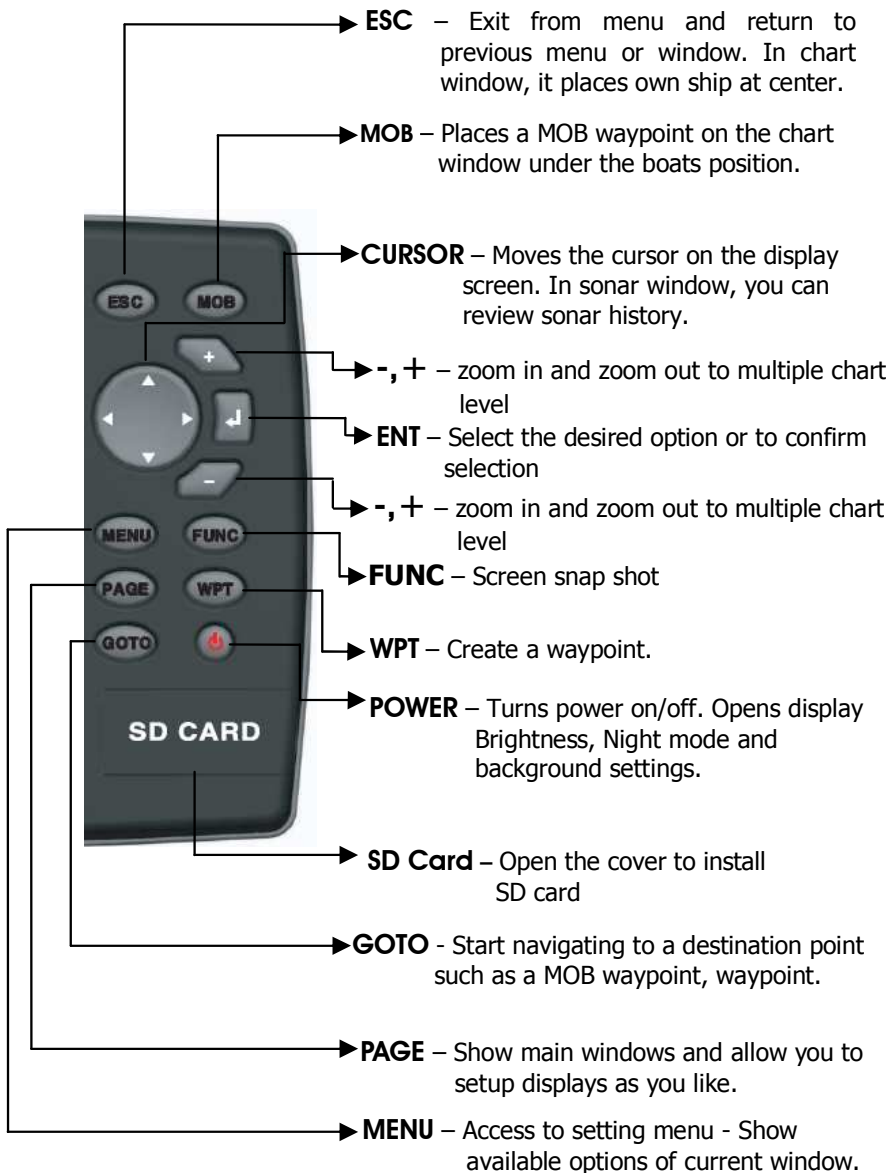

## 2-3 C-MAP MAX Secure Digital (SD) Card

This section provides instructions for inserting and removing C-MAP MAX SD card procedure.

### Inserting the SD Card

- 1 Hold the SD card so that you can see the C-Map label.
- 2 Open the door, gently push the SD card into the slot; push the SD card in as far as you hear click sound, then close door.

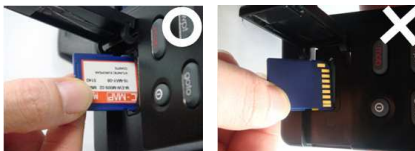

### Removing the SD Card

- 1 Turn off the unit.
- 2 Open the door and push in on the SD card until it is released.
- 3 Close the door.

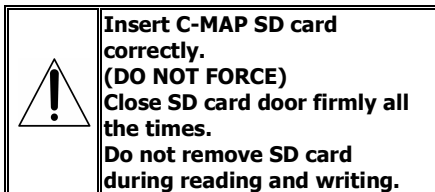

## 2-4 Chart Selection

A user can select a map between C-MAP and S-MAP.

### Chart Selection

- 1 Press and hold .
- 2 Select the system setting icon.
- 3 Select Chart then a chart you prefer.

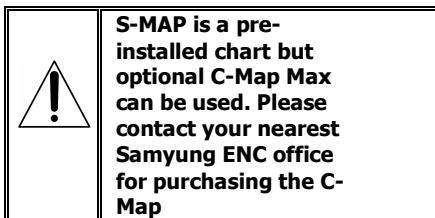

## 2-5 Simulate Mode

Simulate Mode is great for practicing the actual use of a product when the satellites signals and internal alarms are not available. In the simulate mode, the unit turns the GPS receiver off and ignores data from all optional devices.

Two simulate modes are available as below.

- **Normal:** Allows a user to practicing the actual use of a product without satellites connection.
- **Demo:** boat travel alone given route at given speed and show different function of the unit.

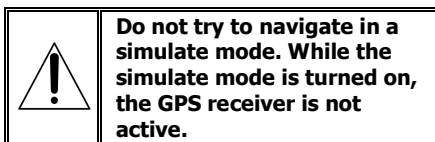

## 2-6 Data Bar

Data bar displays useful navigation information at the top of the display.

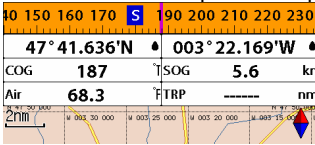

### Displaying Data bar

- 1 Press **MENU** and select **Data bar**.
- 2 Select **Data bar**.

### Setting the data displayed in data bar

- 1 Press **MENU** and select **Data bar**.
- 2 Select **Data bar** then **Data bar setup**.
- 3 Move the cursor key to highlight the data field you want to change then press **↓**.
- 4 Select **Data type**.
- 5 Select a desired data you want to display in the field then press **↓**.
- 6 Repeat above steps if necessary.

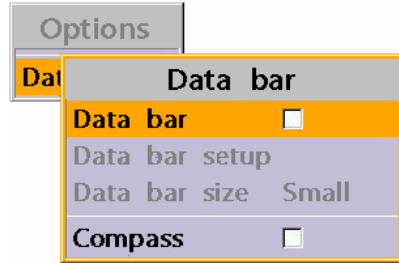

### Selecting the Data bar size

- 1 Press **MENU** and select **Data bar**.
- 2 Select **Data bar** then **Data bar size**.
- 3 Select the desired size of data bar.

#### [Large]

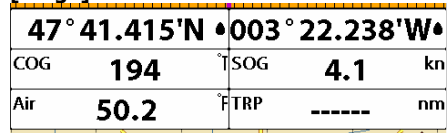

#### [Small]

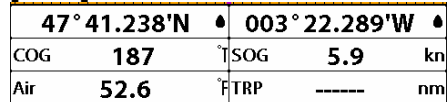

**Tip:** If you select None for all data fields, the data bar will disappear to save space for the chart.

**Tip:** Even though you setup a data bar for specific window, the data bar is not apply to all other window.

## 2-7 Compass

The chart plotter computes compass direction from the constellation of GPS satellites. For the GPS chart plotter to compute direction the vessel must be moving through the water.

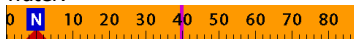

For easy reading and recognition, there is a compass needle at top right side.

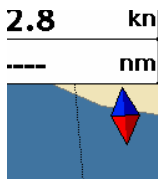

When the compass is displayed, COG is always displayed in data field. Also when you are navigating to a point, COG and BRG is always displayed in data bar.



### Tip

COG(Course Over Ground) – The course you vessel is heading.

BRG(Bearing) – The direction from your current position to a destination point.

To turn the compass off or on:

- 1 Press **MENU** and select **Data bar**.
- 2 Select **Compass**.

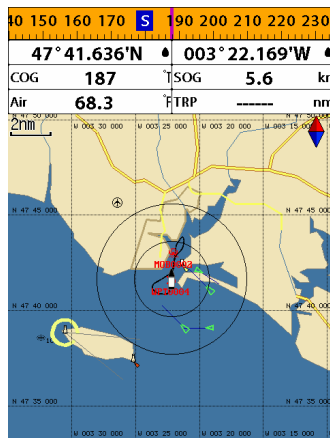





## The active window

To distinguish an active window among windows, an orange border indicates the active window. To change the active window to the next window, press and hold **PAGE**.

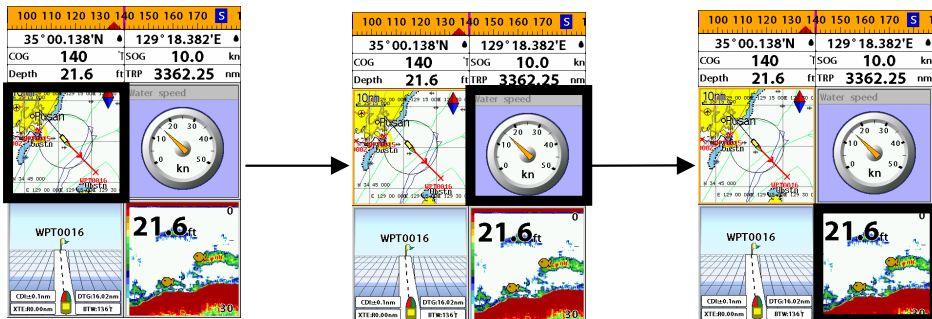

## Favorite displays

The most commonly used windows are called favorite displays and up to six favorite windows can be saved. Also each favorite display can have data bar and compass.



### Displaying a favorite display

- 1 Press **PAGE** twice.
- 2 When above window pops up select a desire display you want.

### Adding a favorite display

- 1 Organize a window as you want.
- 2 Press **PAGE** to show the main window.
- 3 Select **Save** icon at the bottom
- 4 Select an icon where you want to add your favorite display. If you add the new favorite display on existing favorite display new display will overwrite the old display.

## 2-9 Man overboard (MOB)

During navigation, the "MOB" feature provides a one-touch method of storing a location, such as point where a crew member fell overboard. In this mode, the chart plotter places a MOB point on the chart page and all the navigation data shown is related to navigating back to this point, allowing you to retrace your path to the MOB point efficiently.

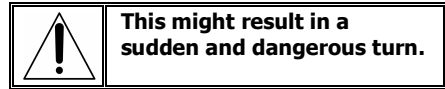
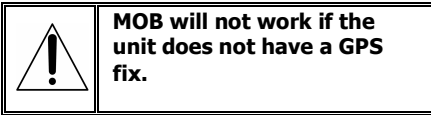

 **Tip:** Even though navigation to MOB waypoint is canceled, the MOB waypoint is not be removed from the waypoint list. To delete the MOB waypoint, you need to delete it manually.

- 1 When you press **MOB**, a MOB waypoint is created.
- 2 When **MOB** is pushed not in the **Chart** window, the screen automatically is changed to **Chart** window and MOB waypoint is at the center of the chart.
- 3 If autopilot is connected, the unit sets the MOB waypoint to be the destination and start to navigate.

## 3 General Operation

### 3-1 Manual / Auto Power on and off

#### Manual power on

Press **[P]** and hold until the display shows the start up page. When the Warning screen appears, press **[P]** to accept.

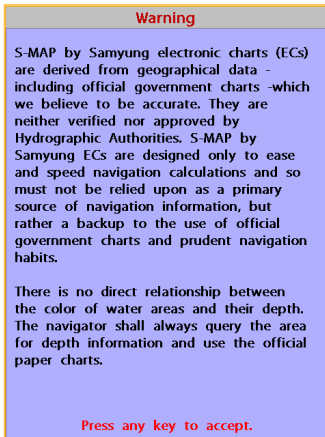

#### Manual power off

Press and hold **[P]** for 5 seconds. A counter timer appears on the screen, if you release the button before the countdown timer reaches zero, the chart plotter will remain On.

#### Auto power

If the unit is wired for auto then:

- The unit turns on automatically when you turn on the boat's ignition.
- You can not turn off the unit if the ignition is turned on.
- If Auto power off is set, the unit turns off automatically when you turn off the boat's ignition.
- If Auto power off is set, the unit will not be turned off even though the boat's ignition is turned off. To turn off, you need to turn off the unit manually.

### 3-2 Brightness, night mode and Background

You can change the screen setting for the display. To change settings, shortly press **[P]**.



#### Brightness

To change the brightness, select **Brightness**, and press **[Left]** to dim or **[Right]** to brighten. Press **[ESC]** to return to the previous screen.

#### Night mode

The chart plotter has preprogrammed settings allowing you to customize the look of the **Chart** window. The default is daytime view. Select **Night mood** depending on what mode the display is in at the time of selection.

To change mode:

- 1 Highlight **Night mode**.
- 2 Press **[Right]** or **[Down]**.

**Tip:** The screen will be difficult to read if the chart plotter is in **night mood** when the sun is too bright

#### Background

You can Change the background color if necessary. This selection is a personal preference. Select the option that gives you the clearest viewing in your weather conditions and viewing angle.

### 3-3 The page window

Press **PAGE** to show the page window and select a function icon you want to display.



#### **Note**

- 1 Some function icons require optional units and connected sensors.
- 2 If you press **PAGE** one more time in the main window, favorite window is displayed.



### Chart

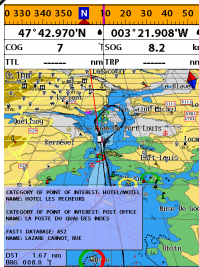

### Sonar

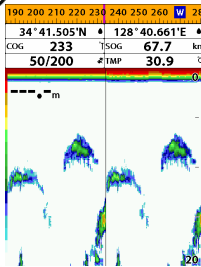

### Highway

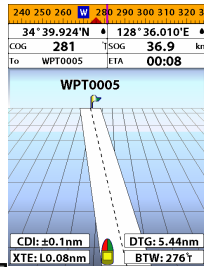

### Data



### Waypoints

NAME	Latitude	Longitude	DIST nm	Dnrg	Disp
MOR0000	47° 43.931'N	103° 01.100'W	0.0	HN	0.0
MOR0009	47° 43.693'N	103° 21.553'W	1.8	HN	1.8
MOR0010	47° 43.693'N	103° 21.553'W	15.5	HN	15.5
MOR0012	47° 43.693'N	103° 21.553'W	15.5	HN	15.5
WPT0002	47° 41.852'N	103° 21.554'W	0.5	No	0.5
WPT0003	47° 41.073'N	103° 21.668'W	1.0	No	1.0
WPT0004	47° 41.315'N	103° 24.635'W	156.2	HN	156.2
WPT0005	47° 42.899'N	103° 24.635'W	248.2	HN	248.2
WPT0006	47° 41.051'N	103° 22.326'W	0.9	Yes	0.9
			182.3	HN	182.3



### Routes

Name	Start	End	Legs	DS (nm)
ROUTE101	WPT0001	WPT0003	2	0.2
ROUTE02	WPT0003	WPT0004	3	1.0
ROUTE03	WPT0001	WPT0003	3	0.7
ROUTE04	WPT0001	WPT0004	3	1.0



### Satellite

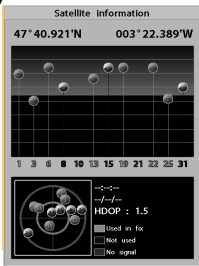

### Tides

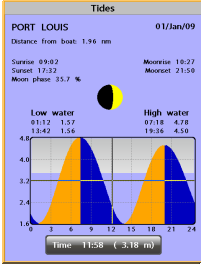

### AIS

DS (nm)	SOG(kn)	BRG (CI)	MMSI	NAME
8.49	5.6	1.233333333		PLASTIMOC
0.76	1.2	2211111111		
1.53	12.3	6066666666		PLASTIMO-A
1.69	7.0	2444444444		LORENTID
1.94	3.4	2522222222		PLASTIMO-B
2.18	15.6	1000000000		LORENTID
2.65	17.0	1699999999		LORENTIE
2.89	9.0	3555555555		LORENTIA
3.25	13.4	1577777777		



### DSC

Date	Latitude	MMSI	Call
12:42	129° 34.507E	11111111	



### Navtex

Time	MegB	Freq
10:51 24/Jan/09	EB3	518kHz
12:02 24/Jan/09	AC55	518kHz
10:20 24/Jan/09	UL13	518kHz

ISSUED ON SATURDAY 24 JANUARY 2009  
 NORTH FORELAND TO SELLEY BIL  
 12 HOURS FORECAST.  
 SHOWERY WINDS, STRONGEST IN NORTH.



### Engine Faults

Engine	Status
Port	Over temperature
Port	Low fuel pressure
Port	Charge indicator
Port	Preheat indicator
Starboard	Low oil pressure
Starboard	Low fuel pressure

## 3-4 Chart

The **Chart** window mainly shows all relevant navigation data available on your preloaded maps, including buoys, lights, cables, depth soundings, marinas, and tide station in an overhead view.

### 3-4-1 Chart window

To go to the **Chart** window:

- Press **PAGE** and select **Chart** icon by pressing **↓**.

A typical Chart window shows:

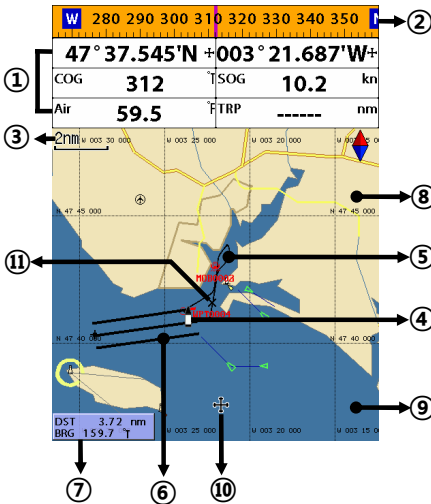

- ① Data bar. To turn the data off or on or to change what data is displayed
- ② Compass
- ③ Chart scale
- ④ Boat position
- ⑤ Boat track
- ⑥ Boat course and CDI lines
- ⑦ Distance and bearing of cursor from boat
- ⑧ Land
- ⑨ Sea
- ⑩ The cursor
- ⑪ A typical waypoint

**The built-in world chart does not show enough detail for navigation. When you use the Chart Plotter to navigate, always use a chart card which covers the region.(C-MAP)**

### 3-4-2 Perspective view

If C-Map is selected for the chart, chart data may be projected in perspective mode during navigation. This function allows setting the panoramic view of the chart. As the upper side of the map is more compressed than the lower side, a wider map area is visible.

The perspective view allows showing more chart information immediately ahead and around the cursor.

To activate this function follow the procedure:

- 1 Press **MENU**.
- 2 Select **Perspective**.

**S-MAP does not support the Perspective View.  
(See 2-4 for chart selection)**

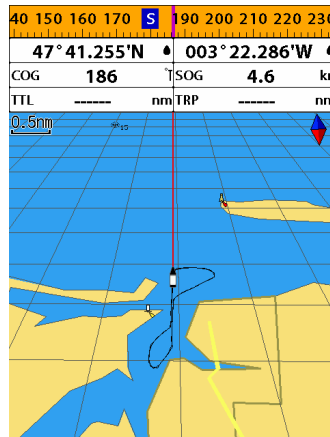

### 3-4-3 Latitude and longitude

Latitude and longitude coordinates define a position on earth and can be displayed in data bar.

In the data bar, own ship position is shown as below:

- ◆ 47° 43.000' N or S Latitude
- ◆ 003° 21.656' E or W Longitude

47° 43.000' N	◆	003° 21.656' W	◆
---------------	---	----------------	---

However, if you move the cursor, then the latitude and longitude in the data bar is the cursor's position as below.

- + 47° 43.325 N or S Latitude
- + 003° 29.607 E or W Longitude

47° 43.325' N	+	003° 20.607' W	+
---------------	---	----------------	---

#### Info

Latitude: Angular distance North or South of the equator measured by lines encircling the earth parallel to the equator in degrees from 0° to 90°.

Longitude: angular distance North or South of the equator measured by lines encircling the earth parallel to the equator in degrees from 0° to 90°.



**When reading the boat position, make sure the position is not the cursor position.**

### 3-4-4 Chart scale

The chart scale change by pressing **+** to show more detail information of chart and by **-** to show wider view of the chart.

When you press **+** or **-**, the scale of chart is display in the chart on top left corner.

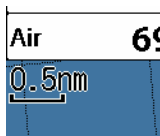

### 3-4-5 Finding a chart symbol

This function is only available when C-MAP SD card is inserted and C-map is selected.

#### To find a port by name

- 1 Press **MENU**.
- 2 Select **Find** then **Port by name**.
- 3 Press **▲** or **▼** to select a letter then press **▶** for next letter.
- 4 Once you enter the name of port, press **↵**.
- 5 After searching process, select a nearest port in the list then the cursor will place on the port you selected on the chart window.
- 6 Repeat 2-3 steps of D section to display the information.

#### To find port & service

- 1 Press **MENU**.
- 2 Select **Find** then **Port & service**.
- 3 Select a service you want to find.
- 4 After searching process, select a nearest service area in the list then the cursor will place on the service area you selected on the chart window.



**S-MAP does not support this function. (See 2-4 for chart selection)**





### 3-4-6 S-Map search

This function is available when C-MAP SD card is inserted and C-map is selected.

#### To find port & service

- 1 Press **MENU**.
- 2 Select **Find** then **Port**.
- 3 Press **▲** or **▼** to select a port then **↓**.
- 4 After searching process, select a nearest port in the list then the cursor will place on the port you selected on the chart window.



### 3-4-7 Chart symbols and information

This function is only available when C-MAP SD card is inserted and C-map is selected.

Using C-Map Max card allows you to show different kind of symbols and their information on chart plotter display. On some objects such as a port, you can see a picture of landscape layout.

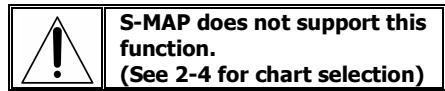

#### To display information

- 1 Move cursor on an icon to display its name.
- 2 Press **MENU** and select **Chart info**.
- 3 Move cursor key to highlight an item and press **↓**.
- 4 Information related to the item appears at the bottom window.

#### [Chart info]

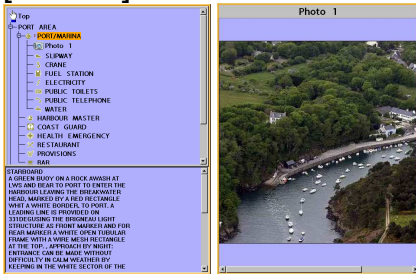

#### [Chart symbol Data Box]



### 3-4-8 Introduction to navigating

Use the navigation chart to plan your course, view map information, and as a navigational aid. This unit has two ways of navigating, going straight to a waypoint or following a route (a group of waypoints).

### 3-4-9 Going to a waypoint or to a point on the chart

A waypoint is a particular location on a voyage whether it is a starting, intermediate or destination point. A waypoint is the simplest piece of information your equipment requires to get you to a destination. In the shortest distance possible. This unit can save up to 10,000 waypoints.

#### Goto Cursor Option

- 1 Press **PAGE** and select the **Chart** window.
- 2 Move the cursor to the destination point.
- 3 Press **MENU** and select **Goto cursor** to start navigating.

#### Goto WPT Option

- 1 Press **PAGE** and select the **Chart** window
- 2 Move the cursor to place cursor on a waypoint.
- 3 Press **MENU** and select **Goto WPT** to start navigating.

#### Find Option

- 1 Press **PAGE** and select the **Chart** icon.
- 2 In the **Chart** window, press **MENU** and select **Find** then **Waypoints**.
- 3 select a waypoint to start navigation.



**Make sure the course does not pass over land or dangerous waters.**

#### Cancelling navigating

- 1 Press **PAGE** and select the **Chart** icon.
- 2 Press **MENU** and select **Cancel Goto**.

### 3-4-10 Following a route

Often a trip from one place to another involves several course changes, requiring a series of route points (waypoints) which you navigate to, one after another. The sequence of waypoints leading to the ultimate destination is called a route. You can save up to 100 routes and a route may consist of 100 waypoints.

#### Start Route Option

- 1 Press **PAGE** and select the chart window.
- 2 Press **MENU** and select **Start Route**.
- 3 Move cursor keys to select a route to start navigating.
- 4 Select **Forward** or **Reverse** to decide which direction you want to navigate.

#### Route Window Option

- 1 Press **PAGE** and select the routes window
- 2 In the route window, mover the cursor to highlight a route you want to start navigating to.
- 3 Press **MENU** and select **start**
- 4 Select **Forward** or **Reverse** to decide which direction you want to navigate.

#### Create Route Option

- 1 Press **PAGE** and select the chart window.
- 2 Select **New route**.
- 3 Name a route name.
- 4 Move cursor keys to select a waypoint.  
(Repeat this step as much as you need)
- 5 Press **MENU** and select **Add**.
- 6 Press **ESC**.
- 7 Repeat 2-4 steps of Route window option.

#### Skipping a waypoint

- 1 Press **PAGE** and select the chart window.
- 2 Press **MENU** and select **Skip**.
- 3 Repeat above step if necessary.

#### Cancelling a route

- 1 Press **PAGE** and select the chart window.
- 2 Press **MENU** and select **Cancel route**.

### 3-4-11 Goto Key

This key is very useful when you desire to start navigating to a destination point. When the key is pressed, it starts navigating to the point of the cursor or Route.

#### Going to a point

- 1 Move the cursor to an open position.
- 2 Press **GOTO**.

### 3-4-12 Distance and bearing calculator

The unit can show the bearing and the length of leg and the total distance of legs.

#### Setting Legs

- 1 In the chart window, press **MENU** and select **Distance**. Information is displayed on window showing bearing/leg distance/total distance at bottom pop up at the bottom left side
- 2 Move the cursor to the start point which is start point of first leg and press **↓**.
- 3 Move the cursor to a point which is the end of first leg.
- 4 Repeat 2-3 steps for more legs.
- 5 Press **ESC** to exit.

#### Deleting the last leg

- 1 Press **MENU** and select **Remove**.
- 2 Repeat above step if you want to remove more legs.

#### Saving as a route

- 1 Once you set all the legs, press **MENU** and select **Save**.
- 2 Enter a route name by pressing **▲** or **▼** to select a letter then press **▶** for next letter.
- 3 Press **↓** to save the new route.

**Tip:** Bearing and distance

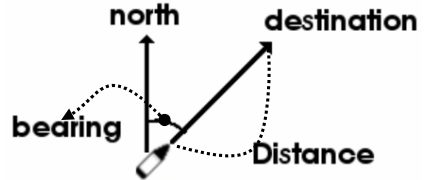

### 3-4-13 Projected course

The projected course shows you how far it can go at give time and speed. This function is very useful to avoid collusion with other vessels.

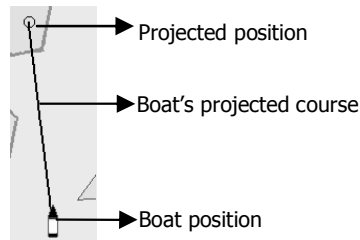

### 3-5 Sonar

The NF560 proposes a sonar function when the unit is connected to an optional depth transducer.

#### To activate sonar function;

- 1 Press and hold **MENU** and select **System Configuration** icon
- 2 Select **Features** then **Sonar**.

#### 3-5-1 Interpreting the display

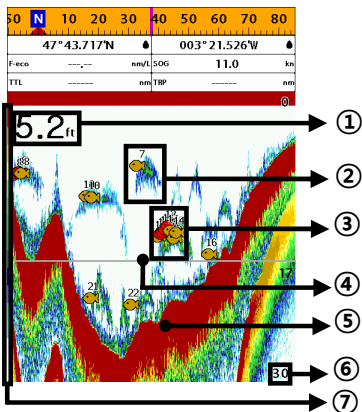

- ① Depth.
- ② Single fish : Fish symbols with depth.
- ③ School of fish.
- ④ Depth line.
- ⑤ Bottom : Hard bottoms such as rock and coral shown as wide bands. Soft bottoms such as mud, weed and sand show as narrow bands.
- ⑥ Range of display.
- ⑦ Color bar.

The window scrolls from right (recent sonar record) to left (old sonar record).

#### 3-5-2 Mode

The unit operates in two different modes. You can choose a mode depending on the condition.

- **Auto mode:** This is the most commonly used option. In this mode, settings are automatically adjusted for the best display of fish and bottom according to environment.
- **Manual mode:** Use this option for manual setting. The option might bring you best result for your purpose.

#### To change a mode;

- 1 Press **MENU** then select **Gain**.
- 2 Select **Mode** then **Manual** or **Auto** and press **↓**.
- 3 Press **ESC** to exit until returning to the **Chart** window.

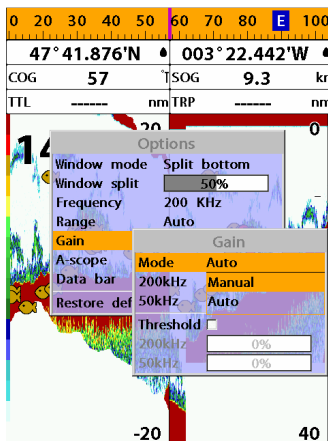

### 3-5-3 Single and Dual frequency fish finding

#### Sonar frequencies

The unit has dual frequency, 200kHz and 50kHz to detect various bottom conditions.

#### To select the sonar frequency in sonar window:

- 1 Press **MENU**, select **Frequency**.
- 2 Select **frequency** and press **↓**.
- 3 Press **ESC** to exit.

#### High frequency (200kHz )

The higher ultrasonic signal, the better is the resolution. For this reason the 200 kHz frequency is ideal for detailed observation of fish schools.

#### Low frequency (50kHz)

The lower frequency signal is, the wider is the detection area. Therefore, the 50kHz frequency is useful for general detection and judging bottom condition.

#### Mixed frequencies (200kHz / 50kHz)

The Mixed frequency combines the 200 kHz and the 50 kHz in the Sonar window. The 50kHz picture appears on the left and the 200kHz picture on the right.

The display is useful for comparing the same picture with two different frequencies.

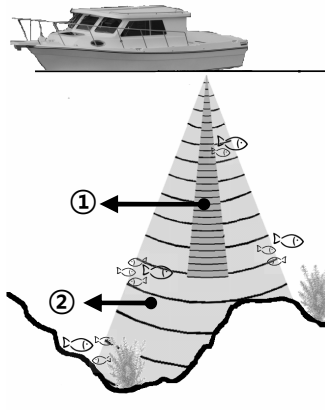

- ① High Frequency (200 kHz)
- ② Low Frequency (50 kHz)

### 3-5-4 Range

Range is the depth of water displayed on the sonar window. The basic range may be chosen in Auto or manual mode.

**Auto:** When the mode is set to **Auto**, the unit adjusts the depth automatically for the best performance. This option is recommended for normal operation.

**Manual:** When the mode is set to **Manual**, the unit only displays the depth of water at a given range. That means the sea bottom might not be displayed in the sonar window or it might display half of display in white because range is more important than sea bottom depth. As shown in below images.

#### To set the manual mode in the sonar window:

- 1 Press **MENU**, select **Range**.
- 2 Select a mode you want and press **↓**.
- 3 If you select the manual mode, press **+** or **-** to change value of max displayed depth.

**[When the set depth is too low]**

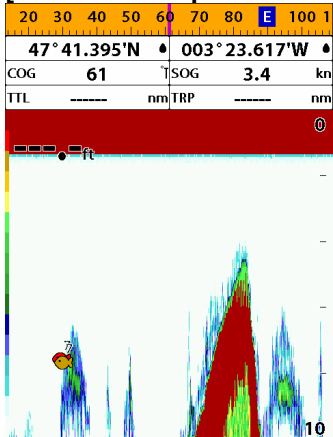

**[When the set depth is too high]**

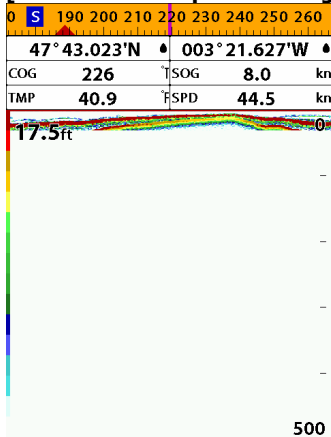

**3-5-5 Gain**

**The gain menu**

The gain is a signal strength received from the transducer and the threshold is the level of ultrasonic that is ignored by a set value. When you use the manual mode and threshold, the values of gain and threshold need to be set very carefully.

In the **Gain** window, you can set for a gain mode and threshold.

Gain	
Mode	Manual
200kHz	10
50kHz	10
Threshold	<input type="checkbox"/>
200kHz	0%
50kHz	0%

**To change a mode,**

- 1 Press **MENU**, select **Gain**.
- 2 Select a mode.
- 3 If you select a **Manual** mode, adjust each frequency gain value by pressing **←** or **→**. Even though you select the **Auto** mode, it will be changed to manual mode if you change the values of frequency.

### 3-5-6 Sonar window display

Five sonar display windows are available and each display window has unique characteristics. Select a display window depending on your needs. The default display is No split.

#### To change a Sonar display window in the sonar window:

- 1 Press **MENU**, select Window mode.
- 2 Select the sonar display you want.

**No split:** Display Sonar history at a given frequency (50 or 200 kHz) (see section 3-5-7)

**Split zoom:** This mode expands chosen area of the normal picture in full vertical size on the left-half part of the window.

**Full screen zoom:** Display a zoomed section on full screen (see section 3-5-8)

**Split bottom:** Display Sonar history and a bottom trace focus in a zoomed section (see section 3-5-9)

**Split 50/200:** Display the 50 kHz sonar history on the left and the 200 kHz sonar history on the right. This display is useful for comparing the same history with two different frequencies. (see section 3-5-10)

**Split A-Scope:** Display Sonar history and echo strength (see section 3-5-11) You can change the split ratio if the window is split.

- 1 Press **MENU** and select **Window split**.
- 2 Press **←** or **→** to adjust the ratio.
- 3 Press **↓**.

Options	
Window mode	Split A-scope
Window split	No split
Frequency	Split zoom
Range	Full screen zoom
Gain	Split bottom
Data bar	Split 50/200
Restore default	Split A-scope

### 3-5-7 No split

**No split** window displays a sonar history at a given frequency (50 or 200 kHz)

#### Low Frequency (50 kHz)

The 50 kHz frequency is ideal for detecting the wider area which means low frequency is useful for general detection and judging bottom condition.

#### High Frequency (200 kHz)

The 200 kHz frequency is ideal provide a better resolution which means it is ideal for the observation of fish or fish schools.

To set a frequency for this display:

- 1 Once you select **No split** window, Press **MENU**.
- 2 Select the sonar icon then **Frequency**
- 3 Select a desired frequency

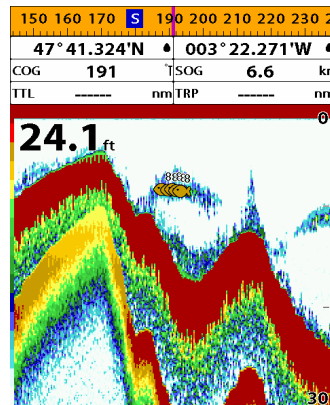

You can also review old sonar records, press **←** and **→** to review the history. To return to current scanning, press **ESC**.

### 3-5-8 Split zoom and Full Screen zoom

#### Split zoom

**Split zoom** mode expands selected area of the single frequency by VRM(Variable Range Mark). The left side displays zoomed section of current sonar record. The VRM of right side indicates the zoom section area.

- Press or to change the zoom range.
- Press or to change the depth range.

#### Bottom lock

If **Bottom lock** is on, the zoom depth (the depth of the zoom section) is adjusted automatically so that the bottom is always displayed in the zoom section.

- To turn Bottom lock on or off press

#### Full Screen zoom

**Full screen zoom** displays only the zoom section of split zoom.

[Split zoom]

[Bottom Lock]

[Full screen zoom]

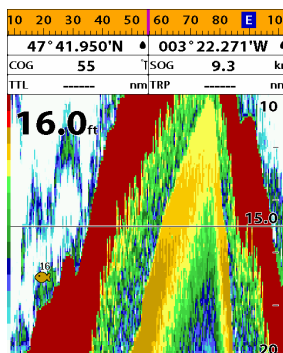
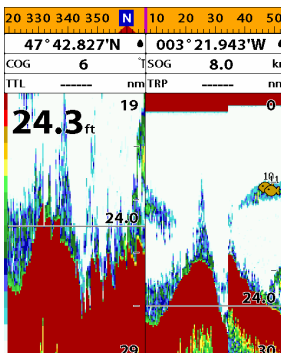
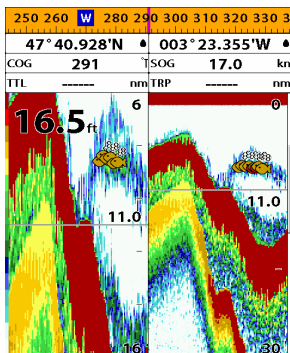

### 3-5-9 Split bottom

**Split bottom** display provides a normal picture on the right half and a selectable range over and below the bottom line is expanded onto the left half of the screen. This mode is useful for detecting bottom fishes.

- Use the or keys to adjust the zoom range.
- Press or to change the range
- The VRM moves up and down to calculate the bottom depth automatically.

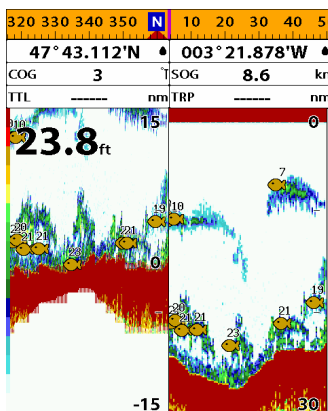



### 3-5-10 Split 50/200

The 50 kHz display appears on the left and the 200 kHz appears on the right. This dual frequency display is very useful for comparing the same scanning with two different frequencies.

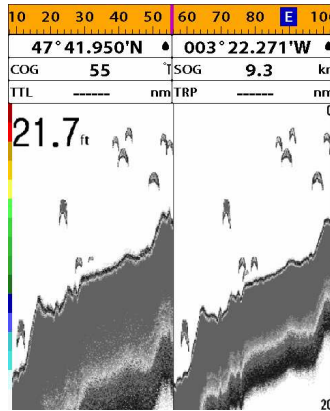

### 3-5-11 Split A-Scope

This display shows echoes at each transmission with amplitudes and colors proportional to their intensities; on the right of the screen it is useful for estimating the kind of fish schools and bottom nature.

Echo strength color code varies from weakest (blue) to strongest (red).

- ① Echoes from fish and the bottom
- ② Unwanted noise echoes.
- ③ The strongest echo, usually from the bottom.

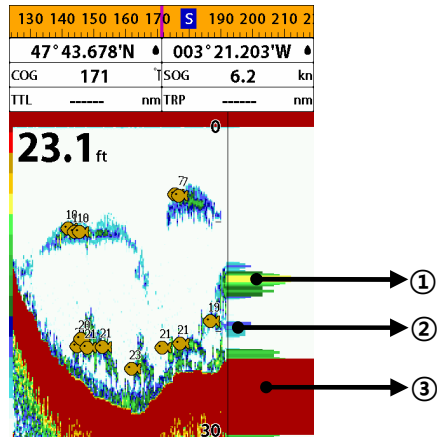

### 3-6 Highway

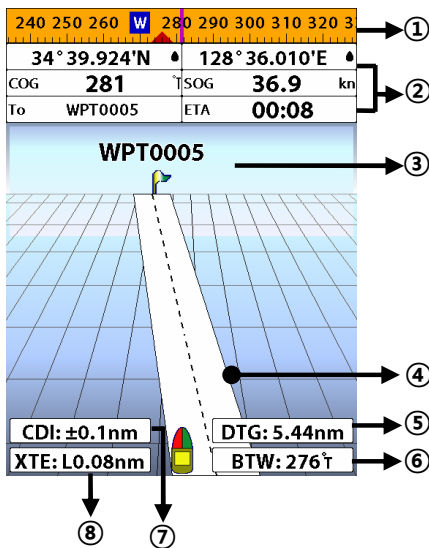

The **Highway** window shows a 3D view of the vessel traveling through the water when navigating to a destination point.

To go to the **Highway** window, press **PAGE** and select **Highway** icon.

The **Highway** window shows:

- ① Compass.
- ② Data bar.
- ③ Destination waypoint.
- ④ Boat's plotted course to destination.
- ⑤ DTG scale (Distance To Go).
- ⑥ BTW scale (Bearing to waypoint).
- ⑦ CDI (Course Deviation Indicator).
- ⑧ XTE scale (Cross Track Error).

### 3-7 Gauges

The **Gauges** window displays all the information you need during navigation such as water, engine, fuel related information, etc.

To select the **Gauges** window, press **PAGE** and select **Data** icon.



#### Selecting a Gauges layout

The **Gauges** window can show one of seven gauge layouts.

- To select a layout from the **Gauges** window:
- 1 Press **MENU** and select **Gauge Layout**.
  - 2 Select one layout.

#### Changing a gauge in one selected

To change a gauge displayed in a layout in Data display.

- 1 Press **MENU** and select **Gauge Setup** then the upper left side gauge will be highlighted.
- 2 Select a gauge you want to change and select Gauge type.
- 3 Select a data type you want to display.



## 3-8 Waypoints

A waypoint is a particular location on a voyage whether it is a starting, intermediate or destination point. A waypoint is the simplest piece of information the unit requires to get you to a destination in the shortest distance possible. This unit can save up to 10,000 waypoints.

To display waypoint list, press **PAGE** and select **Waypoint** icon.

Waypoints				
NAME	Latitude Longitude	DST BRG	rm T	Dnrg Disp
MOB0008	47° 42.293N 003° 22.081W		0.4 20.5	No HN
MOB0009	47° 43.693N 003° 21.553W		1.8 15.5	No HN
MOB0010	47° 43.242N 003° 21.869W		1.3 11.8	No HN
MOB0012	47° 43.693N 003° 21.553W		1.8 15.5	No HN
WPT0002	47° 41.852N 003° 21.556W		0.5 101.6	No HN
WPT0003	47° 41.073N 003° 21.696W		1.0 156.2	No HN
WPT0004	47° 41.315N 003° 24.635W		1.7 248.2	No HN
WPT0005	47° 42.899N 003° 24.355W		1.7 304.1	No HN
WPT0006	47° 41.051N 003° 22.326W		0.9 182.3	Yes HN

to select      to Page Up/Down

### 3-8-1 Creating a new waypoint

#### To create a waypoint from the chart window

There are two ways to create a new waypoint from the chart window as described below:

- 1 Press **WPT** on at the current boat position.
- 2 Move the cursor to a point where you want to create a waypoint and press **WPT**.

#### To create a waypoint from the waypoints window

- 1 Press **MENU** and select **Create**.
- 2 Enter waypoint data, change alphanumeric name, choose between 48 icons, 16 colors and display option.
- 3 Select **Save**.

### 3-8-2 Moving a waypoint

#### To move a waypoint from the chart window

- 1 Move the cursor to place it on the waypoint you want to move. (If you move the cursor on the waypoint correctly, waypoint information will be displayed at the bottom left).
- 2 Press **MENU** and select **Move**.
- 3 Move the cursor to a point where you want to move and press

#### To Move a waypoint from the waypoints window

- 1 Highlight a waypoint you want to move.
- 2 Press **MENU** and select **Edit**.
- 3 change the existing latitude and longitude to new position.
- 4 Select **Save**.

### 3-8-3 Editing an existing waypoint

#### To Edit a waypoint from the chart window

- 1 Move the cursor to the waypoint you want to edit. (If you move the cursor on the waypoint correctly, waypoint information will be displayed at the bottom left)
- 2 Press **MENU** and select **Edit**.
- 3 Edit waypoint data as you need and press

#### To Edit a waypoint from the waypoints window

- 1 Move cursor key to highlight a waypoint you want to edit.
- 2 Press **MENU** and select **Edit**.
- 3 Edit waypoint data as you need and press

### 3-8-4 Deleting a waypoint

To delete a waypoint from the chart window

- 1 Move the cursor to the waypoint you want to delete. (If you move the cursor on the waypoint correctly, waypoint information will be displayed at the bottom left)
- 2 Press **MENU** and select **Delete**.
- 3 Select **Yes**.

**Deleting a waypoint from the waypoints window**

- 1 Move cursor key to highlight a waypoint you want to delete.
- 2 Press **MENU** and select **Delete**.
- 3 Select **Yes**.

**A waypoint can not be deleted if the final destination of navigation is the waypoint.**

### 3-8-5 Find a waypoint

To find a waypoint from the chart window

- Finding waypoints from the chart window is a simplified function.
- 1 Press **MENU** and select **Find**.
  - 2 Select **Waypoints**.
  - 3 Move cursor key to highlight a waypoint you want to find and press **↓**.

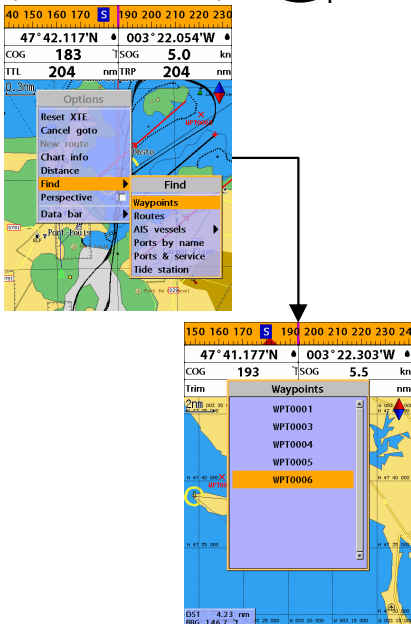

To find a waypoint from the waypoint window

- Finding waypoints from the waypoint window is provided by a full function.
- 1 Press **MENU** and select **Find**.
  - 2 Press **↑**, **↓**, **←** or **→** to find a waypoint name.
  - 3 Select **↓**.

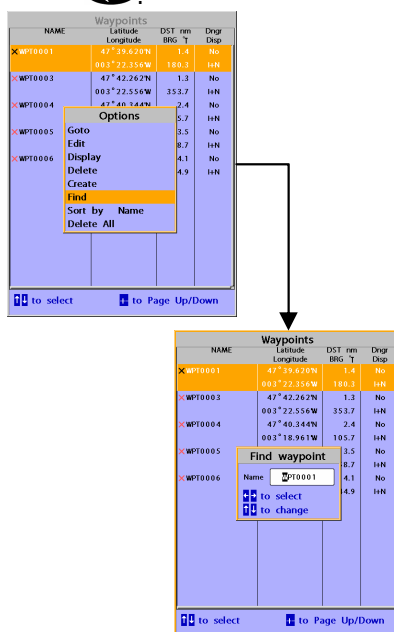

### 3-8-6 Sort Waypoints

To change the order of displayed waypoint list:

- 1 Press **MENU** and select **Sort by**.
- 2 Select a sort type.

### 3-8-7 Deleting all waypoints

- 1 In the waypoints window, press **MENU** and select **Delete all**.
- 2 Select **Yes**.

## 3-9 Routes

A trip from one place to another often involves several course changes, requiring a series of waypoints which you navigate to, one after another. The sequence of waypoints leading to the final destination is called a route. The unit can automatically advance to the next waypoint on a route. So you do not have to change the destination waypoint repeatedly.

The unit has the capability to store 100 routes with maximum of 100 waypoints each.

To display the **Routes** window, press **PAGE** and select the **Routes** window.

Routes				
Name	Start	End	Legs	DST(nm)
ROUTE 01	WPT0001	WPT0003	2	02.
ROUTE 02	WPT0003	WPT0006	3	10.
ROUTE 03	WPT0001	WPT0003	3	07.
ROUTE 04	WPT0003	WPT0006	3	10.

to select      to Page Up/Down

### 3-9-1 Managing a route from the chart window

#### Creating a new route window

- 1 Press **MENU** and select **New route**.
- 2 Enter the new route name using cursor key and press .
- 3 On the **Chart** window, move the cursor to the position of the starting waypoint in the Route and press .
- 4 Move the cursor keys to the position of next waypoint and press .
- 5 Repeat step 4 to enter more waypoints.
- 6 Once you entered the last waypoint in the route, press **MENU** and select **End**.

#### Editing a waypoint in route while creating a route

- 1 Move the cursor to the waypoint you want to move.
- 2 Press **MENU** and select **Move**.
- 3 Move cursor to a position where you want to move the waypoint and press .

#### Deleting a last waypoint from the route while creating a route

- 1 Press **MENU** and select **Delete**.

#### Deleting a waypoint from the route while creating a route

- 1 Move the cursor to the waypoint you want to remove.
- 2 Press **MENU** and **Remove**.

**Tip:** Even though you deleted a waypoint in the route, the waypoint still remains in the waypoint list.

#### Inserting a waypoint while creating a route

- 1 If you want to insert a waypoint between waypoints which will be just after the one you want to insert.
- 2 Press **MENU** and select **Insert**.
- 3 Move the cursor to the new inserted waypoint and press .

#### Inserting a waypoint in front of starting waypoint while creating a route

- 1 Move the cursor to the starting waypoint
- 2 Press **MENU** and select **Insert**.
- 3 Move the cursor to the new start location and press .

Routes			
Name	ROUTE 04		
Leg	Waypoint	Distance(nm)	Bearing(T)
1	WPT0003		
2	WPT0005	3.8	239.0
3	WPT0006		114.9
4			

**Insert waypoint**

WPT0001

WPT0003

WPT0004

WPT0005

WPT0006

WPT0007

WPT0008

WPT0009

WPT0010

WPT0011

WPT0012

WPT0013

to Page Up/Down

to Page Up/Down

### 3-9-2 Managing a route from the route window

#### Creating a route from the route window

- 1 To go to the **Route** window, press **PAGE** and select the **Route** icon
- 2 Press **MENU** select **Create**
- 3 If you want to enter a route name, highlight name and press **↓**.
- 4 Press **✓** and press **↓**.
- 5 Press **▲** or **▼** to highlight a waypoint
- 6 Press **↓** to insert a waypoint
- 7 Repeat step 5 and 6 until you create a route
- 8 Press **ESC** to exit

#### Inserting a waypoint between two waypoints

- 1 In the **Route** window, select a route you want to insert in the route list and press **↓** or press **PAGE** and select **Edit**.
- 2 Highlight a leg where you want to insert a waypoint
- 3 Press **MENU** and select insert
- 4 Highlight a waypoint and press **↓**.
- 5 Press **ESC** to exit

#### Editing a route in the chart window

- 1 In the route list, press **MENU** and select **Edit** on chart.
- 2 Follow the procedure of "Editing a waypoint in route while creating a route"

#### Deleting a waypoint in the waypoint list

- 1 Highlight a waypoint you want to delete in the waypoint list.
- 2 Press **MENU** and select **Remove**.

#### Deleting a route in the route window

- 1 Highlight a route you want to delete.
- 2 Press **MENU** and select **Delete**.

#### Deleting all route in the route window

- 1 Press **MENU** and select **Delete All**.

Displaying a route in the **Chart** window from the route list:

- 1 Highlight a route you want to display in the **Chart** window.
- 2 Press **MENU** and select **Display**.

Routes				
Name	Start	End	Legs	DST(nm)
▶ROUTE 01	WPT0001	WPT0003	2	02.
ROUTE 02	WPT0003	WPT0006	3	10.
ROUTE 03	WPT0001	WPT0003	3	07.
ROUTE 04	WPT0003	WPT0006	3	10.

↑↓ to select      +/- to Page Up/Down

## 3-10 Satellites

### 3-10-1 Satellite information

#### Acquiring GPS signals

When the unit is first turned on it will take some time for the GPS signal acquiring. After signals are received, the unit will automatically find a position of boat in the chart window.

#### Satellite information window

The satellite window displays different information about the GPS satellites and GPS position as below.

To go to the satellite window, press **PAGE** and select **Satellite** icon.

#### The satellite window shows:

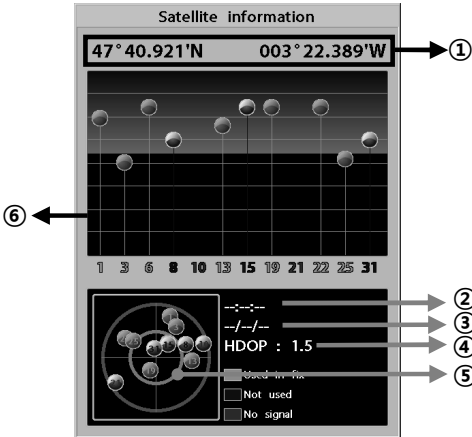

- ① Ship's Coordinates.
- ② Time received GPS satellites.
- ③ Date received GPS satellites.
- ④ HDOP: Horizontal Dilution of Precision. It is a parameter indicating the accuracy of the GPS.
- ⑤ Location of GPS Satellites.
- ⑥ GPS signal strengths status in graph.

Press **↓** to display GPS signal information from GPS satellite in NMEA0183 data format at the GPS signal strengths status display. To return to GPS signal strengths status display, press **↓** again.

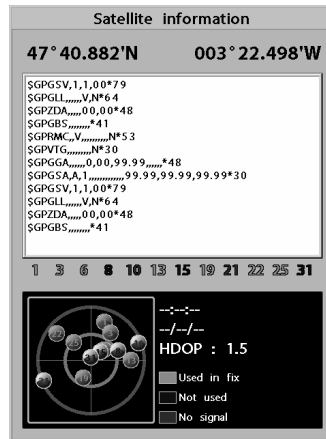



### 3-11 Tides

The **Tides** window is useful for boaters that are concerned about the height of the water or by fisherman that wish to know the tide and moon phase of a specific date.

#### Displaying a tide information from the chart window

- 1 In the **Chart** window, press **MENU**.
- 2 Select **Find and Tide station**.
- 3 Press **▲** or **▼** to move cursor and select a tide station
- 4 Press **▲**, **▼**, **◀** or **▶** to the position of selected tide station and press **↵**.
- 5 Select **Tide height station** to display the information
- 6 Press **ESC** to exit.

#### Displaying tide station information in the tides window

- 1 Press **PAGE** and select **Tides** window.
- 2 Select **Tide height station** to display the information.
- 3 Press **ESC** to exit.

**Tip:** The unit only displays the tide information nearest your boat in the tides windows.

#### Choosing the date of the tide information.

- 1 In the Tides window, Press **MENU** and select one of the following options.
  - **Set date:** manually set a date.
  - **Today:** automatically set the date of today.
  - **Next day:** automatically set the date of today.
  - **Prev day:** automatically set the date of yesterday
- 2 Press **ESC** to return to the window.

#### The tides window shows data for the chosen date

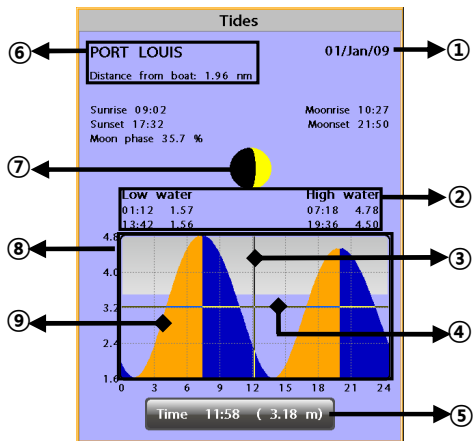

- ① Current time and chosen date for display.
- ② Data for the chosen date.
- ③ Tide height cursor, a horizontal dotted line. Press **▲** or **▼** to move cursor up and down.
- ④ Time cursor, a vertical dotted line. Press **◀** or **▶** to move cursor sideways.
- ⑤ Time of cursor and tide height at that time.
- ⑥ Tide station name and distance from boat.
- ⑦ Moon phase for moon at the current time on the chosen date.
- ⑧ Tide chart.
- ⑨ Tide height.



## 3-12 AIS

AIS is an Automatic Identification System for identification and localization of boat. AIS provide a means for boats to exchange and share boat data including identification, position, course, etc. This information can be displayed on the screen of your unit. AIS is intended to assist you to monitor other boats movements to improve safety and prevent collision.

AIS functions require an optional AIS unit to be installed. Contact your nearest Samyung ENC dealer for more details or visit at [www.samyungenc.com](http://www.samyungenc.com).

To activate AIS function:

- 1 Press and hold **MENU** and select **System Configuration** icon.
- 2 Select **Features** then **AIS**.

### 3-12-1 Viewing AIS Vessels

When the unit is connected to AIS unit which support NMEA0183 or NMEA2000, you can check other vessel that are equipped with AIS unit on the screen. To check AIS information place the cursor on the AIS object then AIS information displays at the bottom of window.

- ① AIS equipped vessel
- ② Dangerous Vessel
- ③ Projected Course
- ④ AIS equipped vessel Data Box
- ⑤ Range Rings

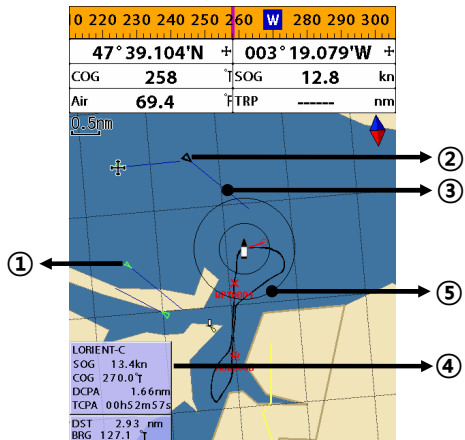

### 3-12-2 AIS Windows

To display the AIS windows:

- 1 Press **PAGE**, and select **AIS** icon.
- 2 Press and hold **PAGE** to select one of the two tabs: **Vessels** or **Messages** tab.
  - **Vessel:** show you all the AIS equipped vessel around you. (up to 200 vessels)
  - **Message:** show you all the messages related to safety from other AIS equipped vessels.

#### Sorting Vessels

- 1 Press **MENU**, select **Sort by**.
- 2 Select one of the options.

#### Displaying an AIS vessel on the chart

To overlay AIS equipped vessel on the chart window:

- 1 Press **▲** or **▼** to select a vessel you want to display in **AIS** window.
- 2 Press **MENU** and select **Display**.

#### Displaying AIS equipped vessel Details

- 1 Press **▲** or **▼** to select a vessel you want to display full AIS detail in the **AIS** window.
- 2 Press **↓** or press **MENU** and select **More Info**.
- 3 Press **←** or **→** to see more detail.

### [AIS Vessel Information -1]

AIS  
Vessels messages  
Vessel info:PLASTIMO-C

Position 007° 57.005'N  
000° 33.678'W  
Heading 0°  
ROT 0° /min  
COG 45.0°  
SOG 5.6kn  
BRG 12.9°  
DST 0.1nm

<> to select page 1/4

### [AIS Vessel List]

AIS

Vessels		messages	
DST(nm)	SOG(kn)	BRG	MMSI
CPA(nm)	TCPA	CT	NAME
0.49	5.6	1	333333333
---	h_m_s		PLASTIMO-C
0.76	1.2	22	111111111
---	h_m_s		PLASTIMO-A
1.53	12.3	6	666666666
---	h_m_s		LORIENT-B
1.69	7.8	2	444444444
---	h_m_s		PLASTIMO-D
1.94	3.4	25	222222222
---	h_m_s		PLASTIMO-B
2.18	15.6	10	888888888
---	h_m_s		LORIENT-D
2.65	17.8	16	999999999
---	h_m_s		LORIENT-E
2.89	9.0	3	555555555
---	h_m_s		LORIENT-A
3.25	13.4	13	777777777

### [AIS Vessel Information -2]

AIS  
Vessels messages  
Vessel info:PLASTIMO-C

Antenna Location

<> to select page 4/4

### [AIS Vessel Safety message]

AIS

Vessels		messages	
Time	MMSI		



### 3-13 DSC

This feature requires connection to optional DSC VHF radio. DSC window shows the distress and poll information received from other vessel through DSC VHF radio.

To go to the DSC windows:

- 1 Press **PAGE**, select **DSC** icon.
- 2 Select one of two tabs: **Distress** or **Poll**.

#### 3-13-1 distress

During a distress situation, a vessel that is equipped with a DSC VHF radio and connected to GPS has the capability to transmit a DSC distress call with GPS position. When a compatible VHF radio receives a distress call, the distress call location is displayed on the screen and it is logged into **DSC Distress** window.

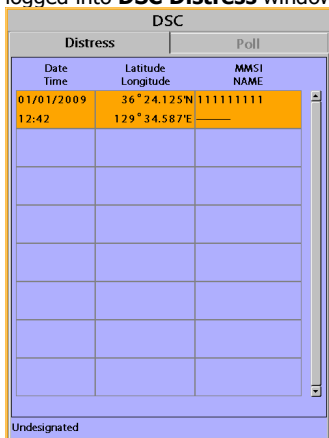

#### Displaying a distressed vessel in the chart window

- 1 Highlight a received distress call you want to display.
- 2 Press **MENU** and select **Display**.

#### Going to the distress position

- 1 Highlight a received distress call you want to navigate to.
- 2 Press **MENU** and select **Goto**.

#### Editing a distress waypoint

- 1 Highlight a received distress call you want to edit.
- 2 Press **MENU** and select **Edit Waypoint**.
- 3 Change data field and select **Save**.



**Tip :** When receiving a Distress call from other vessel, it creates a distress waypoint automatically. However, the waypoint you edit in option menu is a different waypoint from the distress waypoint.

#### Deleting a Distress Call

- 1 Highlight a received distress call you want to delete.
- 2 Press **MENU** and select **Delete**.

#### Deleting all Distress Call

- 1 Press **MENU** and select **Delete all**.



**Tip:** Even though you delete a DSC call, the DSC waypoints still exist.

#### Distress Message

When the distress message is received, the distress message will be popped up as below.

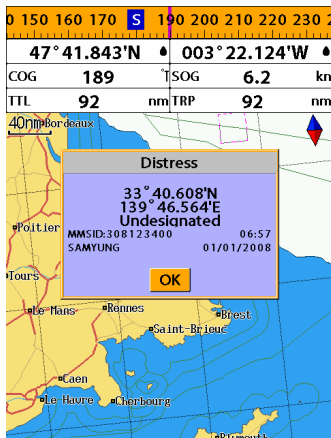

### 3-13-2 Poll

#### Poll

A compatible radio with the unit can request the position of other DSC VHF radio equipped vessels around its position. When the position of a vessel is received, the location is displayed on the screen and it is logged into Poll window

To display the **Poll** tab, press and hold **PAGE**.

#### Displaying an poll vessel in the chart window

- 1 Highlight a poll you want to display.
- 2 Press **MENU** and select **Display**.

#### Going to the poll vessel position

- 1 Highlight a poll you want to go.
- 2 Press **MENU** and select **Goto**.

#### Edit a distress waypoint

- 1 Highlight a poll you want to edit.
- 2 Press **MENU** and select **Edit Waypoint**.
- 3 Change data field and select **Save**.

 **Tip** : When receiving a poll from other vessel, it does not create a waypoint as a distress call

#### Deleting a poll

- 1 Highlight a received distress call you want to delete.
- 2 Press **MENU** and select **Delete**.

#### Deleting all poll

- 1 Press **MENU** and select **Delete all**.

 **Tip**: Even though you delete a DSC call, the DSC waypoints still exist.

DSC		
Distress		Poll
Date Time	Latitude Longitude	MMSI NAME
01/01/2009 12:42	36° 24.000'N 129° 34.000'E	1111111111



### 3-14 NAVTEX

NAVTEX is an international automated direct printing service for delivery of navigational and meteorological warnings and forecast, as well as urgent marine safety information.

NAVTEX functions require an optional NAVTEX receiver with NMEA0183 output to be installed and connected to the chart plotter.

To go to the NAVTEX window, press **PAGE** and select the **NAVTEX** icon.

NAVTEX		
Time	MsgID	Freq
10:51 24/Jan/09	IE03	518kHz
12:02 24/Jan/09	AC05	518kHz
10:20 24/Jan/09	UL13	518kHz

ISSUED ON SATURDAY 24 JANUARY 2009.  
 INSHORE WATERS FORECAST TO 12 MILES  
 OFFSHORE FROM 1700 UTC TO 0500 UTC.

NORTH FORELAND TO SELLEY BILL.  
 12 HOURS FORECAST:  
 SHOWERY WINDS, STRONGEST IN NORTH.

#### Reloading NAVTEX messages

NAVTEX messages need to be loaded from NAVTEX receiver manually. (Up to 50 messages)

1 Press **MENU** and select **Reload all**.

#### Deleting a message

- 1 Move the cursor to a message you want to delete.
- 2 Press **MENU** and select **Delete**.

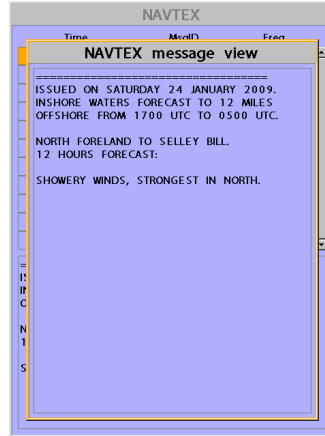

### 3-15 Engine Faults

When connected to a compatible engine through NMEA2000, N560 & NF560 can repeat fuel data, and collect engine status.

Engine faults window show you all the errors or malfunctions of relating to the engine in real time. If any reason causing a problem is solved then corresponding error or malfunction indication will disappear.

# 4 Advanced Settings

The system menu mainly consists of settings which do not require frequent adjustment. To go to system menu, press and hold **MENU** then select the icon you want.



- ① System Configuration.
- ② Chart.
- ③ Sonar.
- ④ GPS.
- ⑤ Track & log.
- ⑥ Memory.
- ⑦ AIS.
- ⑧ Alarms.
- ⑨ Others.
- ⑩ Set Alpha blending (set transparency of menu boxes' background over main windows)

## 4-1 System Configuration Settings

To go to **System configuration**:

- 1 Press and hold **MENU**.
- 2 Select the **system configuration** icon.

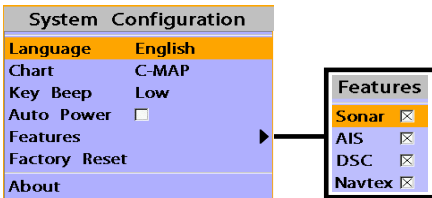

### 4-1-1 Language

Change the language for menus and data screens.

### 4-1-2 Chart Selection

Select a chart between S-MAP or C-MAP chart.

### 4-1-3 Beep volume

Select the level of beep sound.

### 4-1-4 Auto power

See section 3-1.

### 4-1-5 Features

When external devices are connected to the unit, the corresponding options need to be set.

### 4-1-6 Factory reset

When this option is selected. All settings of this unit returns to default factory settings.

### 4-1-7 About

The About window shows:

- 1 Software version and release date.
- 2 C-Map version.
- 3 Stored waypoints, routes and tracks count
- 4 Wiring information of connector.

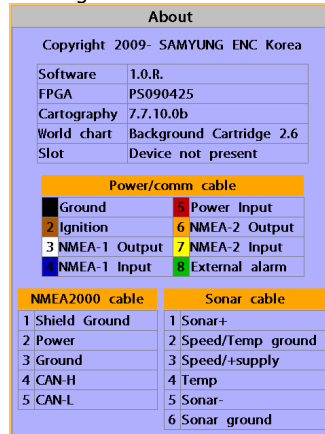

## 4-2 Chart Settings

To go to the chart settings:

- 1 Press and hold **MENU**.
- 2 Select the chart icon.

Chart	
Rotation	North up
Palette	Normal
<b>General</b>	
Land & Sea	
Map Datum	WGS84
NMEA datum offset	<input type="checkbox"/>
Map shift	Off
Restore default	

### C-MAP

General		Land & Sea	
Plotter mode	<input checked="" type="checkbox"/>	Water features	<input checked="" type="checkbox"/>
Mixing levels	<input checked="" type="checkbox"/>	Object depths	<input checked="" type="checkbox"/>
AntiClutter	<input checked="" type="checkbox"/>	Spot soundings	<input checked="" type="checkbox"/>
Value added data	<input checked="" type="checkbox"/>	Sounding min	0 ft
Lat/lon grid	<input checked="" type="checkbox"/>	Sounding max	10 ft
Boundaries	Auto	Tidal stream	<input checked="" type="checkbox"/>
Text/icon Size	Small	Land features	<input checked="" type="checkbox"/>
Names	<input checked="" type="checkbox"/>	Land elevation	<input checked="" type="checkbox"/>
Nav-aids & Light Sector On	<input checked="" type="checkbox"/>	Security navigation zone	<input checked="" type="checkbox"/>
Nav-aids	INT		
Attention areas	<input checked="" type="checkbox"/>		
Projected course	Off		
CDI scale	0.1 nm		

Security navigation zone	
Enabled	<input checked="" type="checkbox"/>
Value	5 ft

### S-MAP

General		Land & Sea	
Lat/Lon grid	<input checked="" type="checkbox"/>	Land	6
Depth Digit	<input checked="" type="checkbox"/>	Mud	4
Lighthouse	<input checked="" type="checkbox"/>	Rocky	5
Buoy	<input checked="" type="checkbox"/>	5 m	13
Wreck Ship	<input checked="" type="checkbox"/>	10 m	12
Fish Haven	<input checked="" type="checkbox"/>	Sea	
Sea Lane	<input checked="" type="checkbox"/>	20 m	3
Restricted Area	<input checked="" type="checkbox"/>	30 m	9
Fishing Area	<input checked="" type="checkbox"/>	50 m	13
Sea Cable	<input checked="" type="checkbox"/>	100 m	12
Name	<input checked="" type="checkbox"/>	200 m	6
Mark Attribute	<input checked="" type="checkbox"/>	300 m ~	7
Sea Sector No	<input type="checkbox"/>		
EEZ Area	<input type="checkbox"/>		
Projected course	Off		
CDI scale	0.1 nm		

### 4-2-1 Rotation

Three types of display presentations are provided. The default is heading up.

**North up:** North is at the top of the display.

**Heading up:** When course is set, the course is at the top of screen all the times.

**Course up:** When destination is set it is at the top of the screen. This option is only available when you are navigating to a destination.

### 4-2-2 Palette

Palettes are used to enhance the visibility of the display depending on the surrounding light environments. Four types of displays are provided; Normal, NOAA, Sunlight and Night.

#### 4-2-3-1 General(C-MAP)

**Plotter mode:** this mode allows you to zoom in and out at scales where cartographic data are not available.

**Mixing levels:** when the map coverage at the current chart scale does not fill the entire display, the GPS chart plotter draws the rest of map using charts from above and below the current scale. When this function is turned on you will notice the display may redraw 2 to 3 times to show all the detail.

**AntiClutter:** when this option is selected, less important information (names & icons) are hidden when they are overlapped.

**Value added data:** The Value Added Data(VAD) is a collection of additional cartographic objects which are not present on the original paper chart. These objects have been obtained from other sources and then merged to the electronic charts in order to provide more information useful for the navigation.

**Lat/Lon Grid:** Turns the displaying of the latitude and longitude grid lines on or off on the chart window.

**Boundaries:** Turns the displaying of chart boundaries on, off or auto mode which shows the chart boundaries of the two charts below the current scale.

**Text/Icon Size:** change the size of text and icon on the chart.

**Names:** Display area names in the chart.

**Nav-aids & Light Sector:** Turns the presentation of Light, Signals, Buoys and Beacons On, Off, No Sector (Nav-Aids are shown, Light Sectors are hidden) or Animated (The lights are flashed).

**Nav-aids:** The way to display fog, radar and radio station signals. (International and US)

**Attention areas:** Turns the displaying of Attention Areas where need to pay attention more) On or Off.

**Projected course:** Display the Projected course in given set time.

**CDI scale:** Set CDI (Course Deviation Indicator) scale which is a parallel line on either side of the pottedter course.

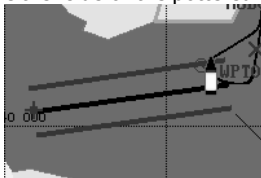

#### **4-2-3-2 General(S-MAP)**

**Lat/Lon grid:** Turns the displaying of Lat/Lon on or off

**Depth Digit:** Turns the displaying of water depth on or off

**Lighthouse:** Turns the displaying of Lighthouse on or off

**Buoy:** Turns the displaying of buoys on or off

**Wreck Ship:** Turns the displaying of Wreck Ship on or off

**Fish Haven:** Turns the displaying of Fish Haven on or off

**Sea Lane:** Turns the displaying of Sea Lane on or off

**Restricted Area:** Turns the displaying of Restricted area on or off

**Fishing Area:** Turns the displaying of Fishing Area on or off

**Sea Cable:** Turns the displaying of Sea Cable on or off

**Name:** Turns the displaying of area name on or off

**Mark Attribute:** Turns the displaying of Mark Attribute on or off

**Sea Sector No:** Turns the displaying of Sea Sector No on or off

#### **4-2-4-1 Land & Sea (C-MAP)**

**Water features:** Turns the displaying of sea bed nature and tide stations icon on or off.

**Object depths:** Turns the displaying of object depths on or off.

**Spot soundings:** Turns the displaying of spot sounding on or off.

**Sounding min:** Set the minimum depth limit to show depth sounding, bathymetric lines and depth area.

**Sounding max:** Set the maximum depth limit to show depth sounding, bathymetric lines and depth area.

**Tidal stream:** Turns the displaying of tidal streams on or off.

**Land Features:** Turns the displaying of land features on or off.

**Land elevation:** Turns the displaying of land elevations on or off.

**Safe Navigation Area:** Set the water depth for safe navigation and displaying safe navigation area in color.

#### **4-2-4-2 Land & Sea (S-MAP)**

Turns the displaying of sea color in 16 different colors.

#### **4-2-5 Map datum**

This unit has a compatibility with most of major chart system and this option allows you to select a map datum. The default datum is WGS84.

Map datum Selection

- 1 Press and hold **MENU** and select chart icon
- 2 Select general and Map datum
- 3 Select a desired map datum



#### 4-2-6 NMEA datum offset

When you select other Map datum different from WGS84, latitude and longitude will be different from WGS84'S coordinates and this might confuse other device such as VHF radio if connected to the unit. If this option is applied, latitude and longitude send on the unit NMEA output will be the same as coordinates in WGS84.

#### 4-2-7 Map shift

Sometimes current position of own ship does not match with the current location on the chart. To correct this position error, you can apply a map shift.

##### Applying a map shift

- 1 In the Chart setup menu, press and hold **MENU** and select **Chart** icon.
- 2 Select Map shift to **ON**.
- 3 Move cursor to the actual position on the chart.
- 4 Press **MENU** and select **Set**.

##### Canceling a map shift

If you want to clear the map shift:

- 1 In the Chart setup menu, select **Map shift**.
- 2 Press **MENU** and select **Clear**.

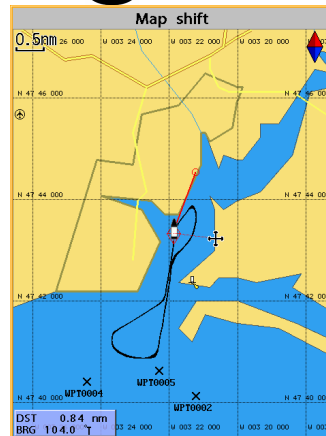

#### 4-2-8 Restore default

Returns every chart settings to default.

## 4-3 Sonar Settings

Sonar feature requires a connection to depth transducer.

To go to the Sonar settings:

- 1 Press and hold **MENU**.
- 2 Select the **Sonar** icon.

Sonar	
<b>Frequency</b>	50 KHz
<b>Palette</b>	White
<b>Scroll speed</b>	Fast
<b>Digit size</b>	Medium
<b>Fish</b>	
<b>Advanced settings</b>	
<b>Restore default</b>	

Fish	
<b>Fish symbols</b>	<input type="checkbox"/>
<b>Fish depth labels</b>	<input type="checkbox"/>
<b>Fish filter</b>	Medium
<b>Fish sensitivity</b>	Low
Advanced settings	
<b>Interference filter</b>	<input type="checkbox"/>
<b>Noise filter</b>	Off
<b>Surface clutter filter</b>	<input type="checkbox"/>
<b>Pulse length</b>	Auto
<b>Pulse power</b>	Auto

### 4-3-1 Frequency

You can select a sonar frequency among 200 kHz, 50 kHz or Mixed.

### 4-3-2 Palette

Palettes are used to enhance the visibility of the display depending on the surrounding light environments. Three types of displays are provided black, blue and white.

### 4-3-3 Scroll speed

You can set the scroll speed which determines how quickly the vertical scan lines run across the screen. Five speed options are provided; Very Fast, Fast, Medium, Slow and Pause. A faster option is recommended for slow speed to see more details and a slow speed is recommended for fast slow speed.

### 4-3-4 Digit size

You can change the size of the depth window on the Sonar window. Three options are available Small, Medium or Large.

### 4-3-5 Fish

**Fish symbols:** Turn the fish symbol on or off.

**Fish depth labels:** Turn the fish depth value on or off.

**Fish filter:** Select a minimum fish size that will be displayed as a fish symbol.

### Fish sensitivity

Select the minimum strength fish echo that will be displayed as a fish symbol.

### 4-3-6 Advance Settings

**Interference filter:** Interference from other equipment operating nearby or on your boat may show itself on the display. Use this option to remove interference.

**Noise filter:** If there is noise, the echo signal from transducer is not stable. This function remove noise and averages the echo signal. However, this option may also remove fish echoes.

**Surface clutter filter:** This filter removes surface noise. However, the function does not remove fish echoes.

**Pulse length:** You can select specific pulse length of transducer. A short pulse shows more detailed information but can't show deeply into the water because of less power. The Auto setting is recommended.

**Pulse power:** You can select specific pulse power of transducer. Low power shows a clear display but can't show deeply into the water. The Auto setting is recommended.

### 4-3-7 Restore default

Returns every sonar settings to default.



## 4-4 GPS Settings

To go to the GPS settings:

- 1 Press and hold **MENU**.
- 2 Select the **GPS** icon.

GPS	
GPS source	Internal
DGPS source	None
Static navigation	Off
Speed filter	Off
Course filter	Off
Lat/Lon d.p's	3
Ship speed	Fast
Magnetic Variation	

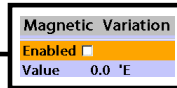

When the GPS device is connected properly, the GPS settings provide the access to GPS functions and features connected with the satellites information used for further navigation.

### 4-4-1 GPS Source

Select a source of GPS signals

**Internal:** Select this option when uses the internal GPS antenna.

**NMEA0183 & NMEA2000:** Select this option when using an external GPS or DGPS antenna via NMEA.

### 4-4-2 DGPS Source

Select WAAS/EGNOS when you want to utilize DGPS.

### 4-4-3 Static Navigation

This option is very useful when the boat stops or moves very slowly. This option allows you to set a minimum speed at which movement is assumed. The value range is from 0.00 to 9.99.

### 4-4-4 Speed Filter and Course Filter

Occasional waves and wind at sea affect the boat speed and course. In order to have stable boat speed and course, the unit calculates these factors to give the value of stable speed and course information.

### 4-4-5 Lat/Lon d.p's

Select number of last digit of Lat/Lon to be sent to other marine electronics.

### 4-4-6 Ship speed

To have more precise boat speed and course, you can select your boat speed. Mid is highly recommended option for the most of common boat.

### 4-4-7 Magnetic Variation

This option compensates the difference between true north and magnetic north.

## 4-5 Track & Log Settings

To go to the tracking and long settings:

- 1 Press and hold **MENU**.
- 2 Select the **track & log** icon.

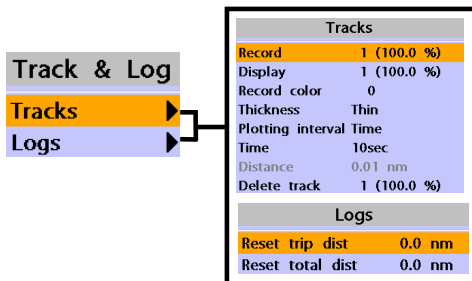

The unit has the capability to store 10 individual tracks and record up to 15,000 track points. Before using the track function you will need to setup the track function that suits your boat.

### 4-5-1 Track

#### Record

Off: Stop a recording of Track

1 to 10 (select a track number): Start a recording of the boat's course.

#### Display

Off: Display no track on the chart.

1 to 5 (select a track number): Display a selected track on the chart.

#### Record color

Select the color of recording track.

#### Thickness

Select the thickness of recorded track.

#### Plotting Interval

Select the method of plotting interval between time and distance.

#### Distance

Select the distance of plotting interval.

#### Time

Select the time of plotting interval.

#### Delete track

Delete a selected track record.

### 4-5-2 Logs

#### Reset trip dist

Shows you the trip distance. If you select this option it resets the trip distance.

#### Reset total dist

Show you the total trip distance. If you select this option it resets the total trip distance.





### 4-7-2 Alarm option

**Dangerous Vessel Alarm** : When this option is selected an alarm will activate. Even this option is not selected; dangerous vessels will still be on the chart.

**TCPA Limit** : Set the Time of Closet Point of Approach limit.

**CPA Limit** : Set the Closet Point of Approach limit.

**Proximity alarm** : Trigger an alarm when any AIS equipped vessel is within a set proximity radius.

**Proximity radius** : Set a radius for proximity alarm.

### 4-7-3 Display options

**Projected course** : Set a time for projected course. The project course show the estimate course of vessel base on the given time.

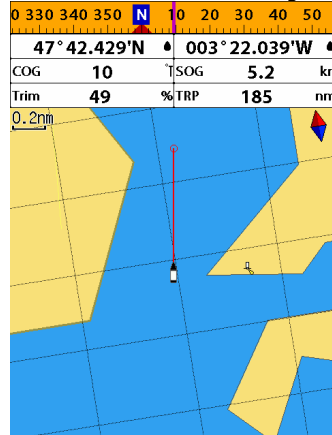

**Range rings** : Select a number of Range rings.

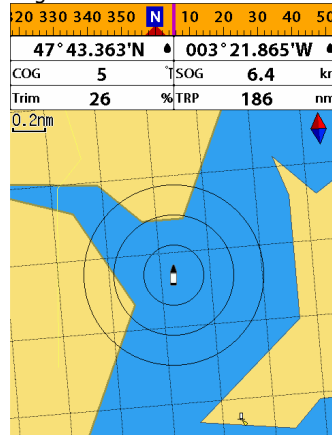

### 4-7-4 Restore default

Returns every AIS setting to default.

## 4-8 Alarms

Press and **MENU** then **Alarms**:

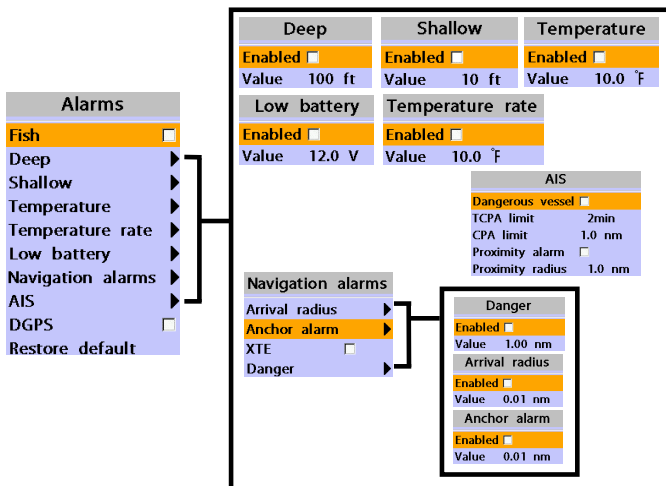

A warning message with beep sound is displayed when an alarm condition is met by user setting. Press **ESC** to clear the alarm. However, the alarm will be displayed again when the alarm condition occurs again. The unit provides alarms for various functions.

### **4-8-1 Fish**

Trigger an alarm when echo from the transducer is matched to preprogrammed fish profile.

### **4-8-2 Deep**

Trigger an alarm when the depth value received from the transducer is deeper than a set value.

### **4-8-3 Shallow**

Trigger an alarm when the depth value received from the transducer is shallower than a set value.

### **4-8-4 Temperature**

Trigger an alarm when the reported temperature from the transducer is same as a set value.

### **4-8-5 Temperature rate**

Trigger an alarm when the rate of temperature change from the transducer is same as a set value.

### **4-8-6 Low battery**

Trigger an alarm when battery voltage is lower than a set value.

### **4-8-7 Navigation alarms**

**Arrival radius** : Trigger an alarm when your boat is approaching the destination to set value

**Anchor alarm** : Trigger an alarm when your boat moves more than set valve

**XTE** : Trigger an alarm when your boat moves off the current CDI scale.

**Danger** : Trigger an alarm when your boat is getting closed to dangerous point.

### **4-8-8 AIS**

See the Alarm option of 4-7 (AIS Settings).

### **4-8-9 DGPS**

Trigger an alarm when DGPS signal is not received.

### **4-8-10 Restore default**

Returns every alarm settings to default.





## 4-9 Others

Press and **MENU** then **Others**:

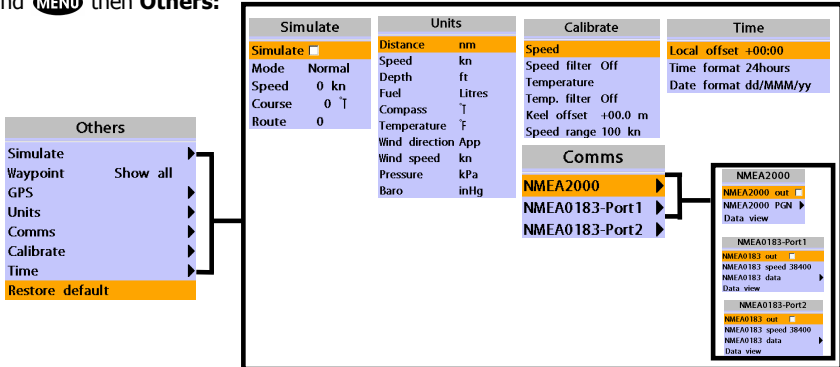

### 4-9-1 Simulate

**Simulate** : Turn the simulate mode on or off.

**Mode** : See 2-4 Simulate Mode.

**Speed** : The simulated boat speed to use.

**Course** : The simulated course over ground.

**Route** : The route to follow.

### 4-9-2 Waypoint

Select a way to display waypoints.

### 4-9-3 GPS

See 4-4 GPS Settings.

### 4-9-4 Units

Select a unit of each measure.

**Tip**: Requires an optional VHF receiver with barometer connected: InHg or mB.

### 4-9-5 Comms

Use this feature when the unit is connected to other marine electronics through any compatible NMEA instrument.

**NMEA0183/NMEA2000**: This option to transmit NMEA sentences to other marine electronics. NMEA0183 and NMEA2000 interfaces are generally used with third party marine electronics. Select a port (NMEA2000, NMEA0183-Port 1 or NMEA0183-Port 2), a communication speed and select a desired output data.

### 4-9-6 Calibrate

**Speed** : Calibrate the boat speed. Travel at a constant known speed and press or to calibrate the speed.

**Speed filter** : Set this option when removing effects from waves and wind which affect the speed of boat by averaging.

**Temperature** : Calibrate the water temperature. Measure the water temperature with thermometer then press or to calibrate the temperature.

**Temperature filter** : Set this option when removing effects from water turbulence and currents cause the water temperature to fluctuate slightly.

**Keel offset**: A depth measured by a transducer is depending on where the transducer is installed. You can adjust the depth of water in consideration of depth of transducer installed in the water.

**Speed range**: Set a maximum speed of boat that can be read in the unit.

### 4-9-7 Time

**Local offset** : The time information supplied by the GPS satellites is in UTC (Universal Time Coordinates). To read the correct time, change the time of GPS chart plotter for daylight saving time start and end.

**Time format** : Select the format of time.

**Date format** : Select the format of date.

### 4-9-8 Restore default

Returns every other setting to default.

### 4-9-9 Calendar

Provide a calendar function.

# 5 INSTALLATION

Correct installation is important to the performance of the unit. It is vital to read the entire installation section of this manual and the documentation that comes with the antenna and any other units before starting installation. For further information, please contact Samyung ENC.

## 5-1 Options and Accessories

### Optional sensors and instruments

- External alarms
- GPS or DGPS antenna
- Sonar transducer
- Fuel sensors
- DSC VHF radio
- NMEA 2000: The chart plotter can display engine data and.
- Other instruments: The chart plotter can receive data from other instruments and send data to other instruments by NMEA.

### Connections

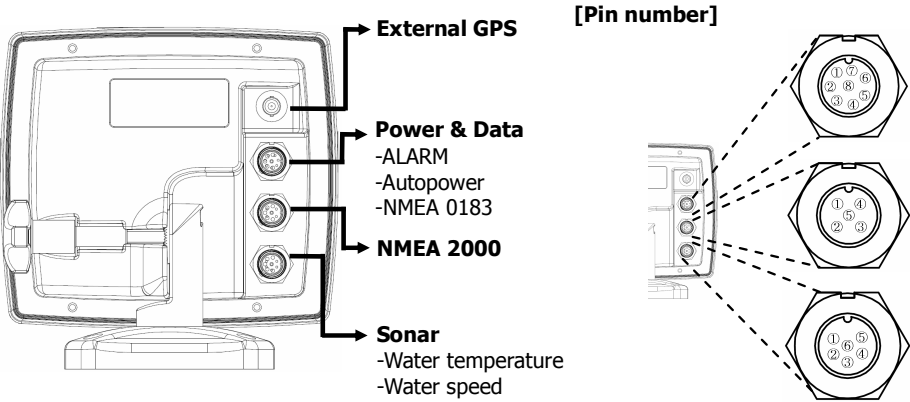

### [Power & Data(ALARM, Auto power)]

Number	Color	Function
1	Black	Ground: - power in, NMEA ground.
2	Brown	Ignition_On
3	White	NMEA 1 Out
4	Blue	NMEA 1 In
5	Red	+ power in, 12 to 34 V DC
6	Orange	NMEA 2 Out
7	Yellow	NMEA 2 In
8	Green	External alarm

**[Sonar]**

Pin number	Detail
1	SONAR +
2	SPEED / TEMP. GND
3	SPEED / + SUPPLY
4	TEMP.
5	SONAR -
6	SONAR GND

## 5-2 Connections

The GPS chart plotter has connectors that are used to connect to the power supply, GPS antenna and to NMEA devices such as VHF's AIS receivers, digital instruments and autopilots.

## 5-3 Power/data cable

**Basic power**

- Wire the display unit for basic power as below picture.

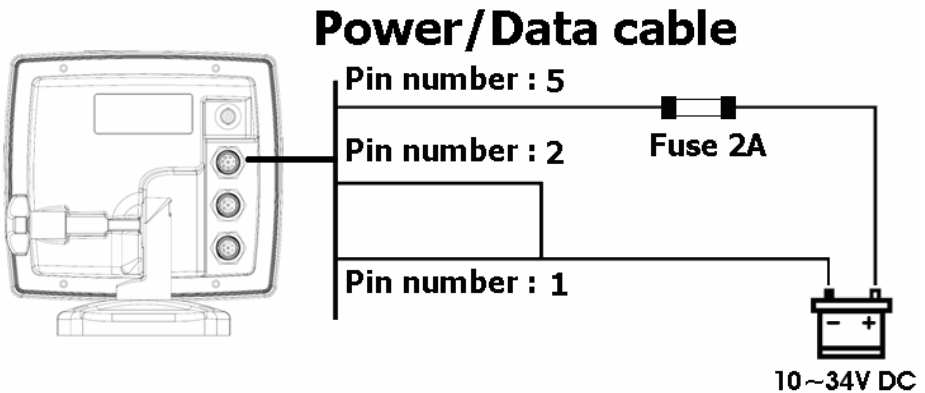

### Auto power

- Wire the display unit for auto power as below picture.
- During setup, set up Auto power off.

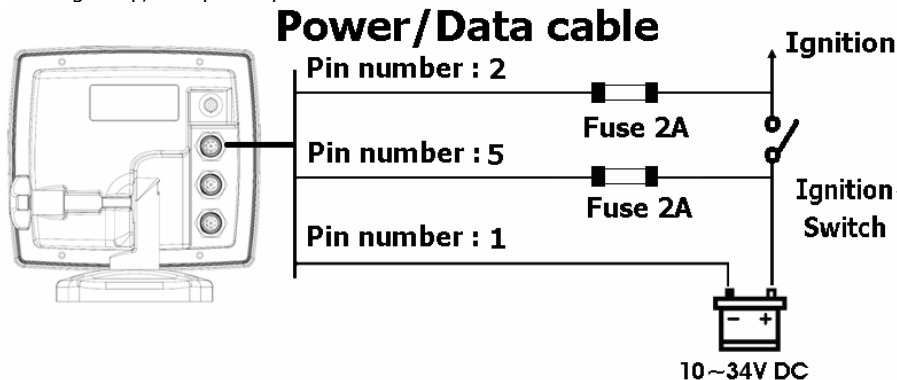

## 5-4 Alarm

- Wire the chart plotter for any external alarm beepers or lights as below picture.
- The output from the unit to external alarm is maximum 30V DC 200mA. It is needed to fit a suitable relay.

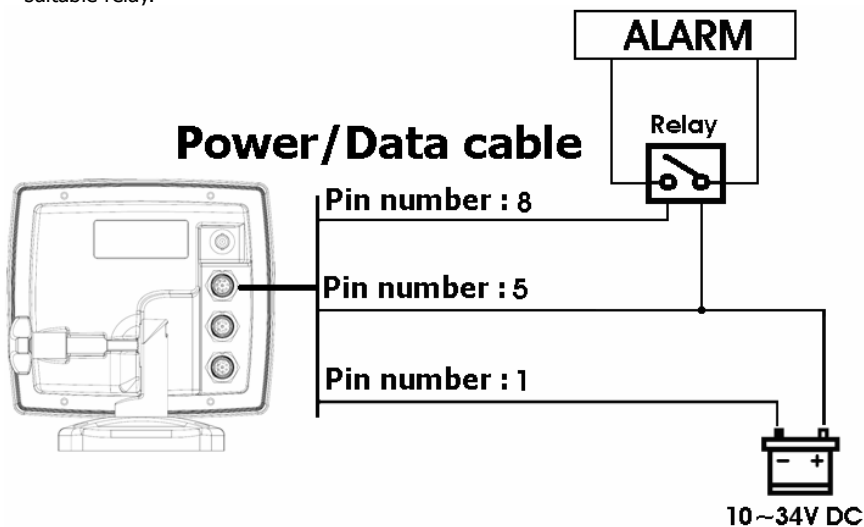

## 5-5 GPS antenna

### Selecting an antenna

Fit one of these GPS antennas:

#### 5-5-1 Internal antenna

The chart plotter is supplied with internal antenna to be able to use it without signal input. The chart plotter have a internal GPS antenna, you can use it without the input of the external signal.

#### 5-5-2 External antenna

Reception of internal GPS antenna is affected by the location to be installed the display unit. If GPS signal is weak or to receive enhanced GPS signal, you can connect external GPS antenna to the unit. The connector is BNC type.

#### Installing a external antenna

If an external antenna is required, install the antenna and fit the antenna cable back to the display unit. Follow the instructions in the manual supplied with the antenna. Fit an optional extension cable if required.

During setup, configure the data for the chosen antenna.

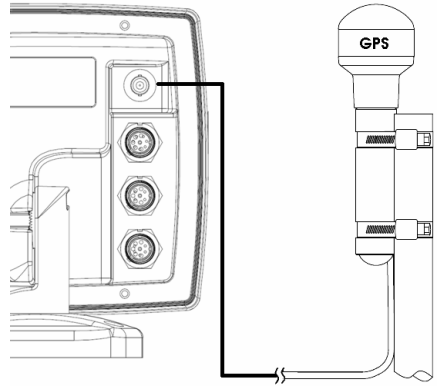

#### 5-5-3 The antenna using NMEA

The chart plotter can receive the GPS data from the compatible device (NMEA). The chart plotter can connect several devices to an external GPS.

- An optional differential beacon DGPS antenna to give enhanced accuracy within range of land based differential beacons in areas where WAAS or EGNOS are not available. Such a DGPS antenna has both a GPS receiver and a beacon receiver, and it automatically applies the beacon correction to the GPS position.

#### To set the DGPS options(None or WAAS/EGNOS):

Connect the GPS directly to the input. Set the option. The new setting will be displayed if it was successfully applied.

#### Note:

The chart plotter can apply the WAAS and EGNOS DGPS corrections to any GPS antenna.

For more information, contact Samyung ENC.

## 5-6 NMEA 0183

The GPS chart plotter can be connected to external devices with NMEA0183 and display information such as followings.

- DSC VHF Radio
- GPS antenna(NMEA 0183)
- Navtex
- AIS receiver

### Power/Data cable

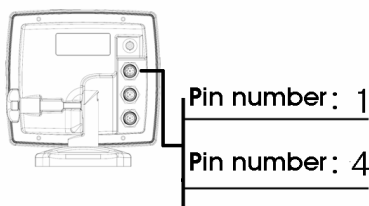

Input (1) NMEA 0183

### Power/Data cable

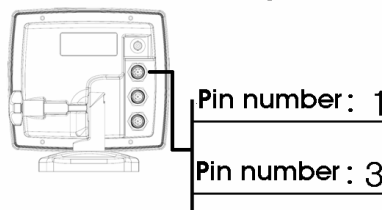

Output (1) NMEA 0183

### Power/Data cable

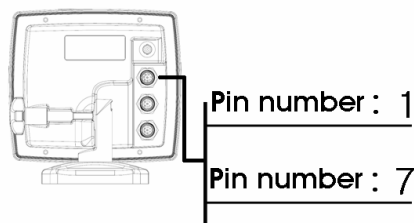

Input (2) NMEA 0183

### Power/Data cable

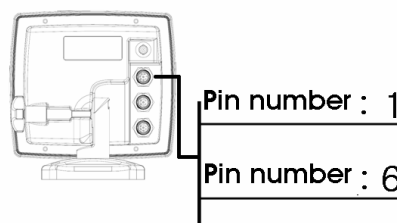

Output (2) NMEA 0183

### DSC VHF radio

Fit and set up the optional DSC VHF radio as above Pictures: NMEA 0183(1) IN and NMEA 0183(2) IN.

### Other NMEA instruments

NMEA is an industry standard for interconnecting instruments. The chart plotter can be connected to other NMEA instruments. Set up the optional NMEA instruments as above pictures.

- The chart plotter can receive and display depth, paddlewheel boat speed and water temperature from an optional compatible instrument.
- The chart plotter can receive data from an optional compatible GPS or GPS/DGPS source.

- The chart plotter can send GPS position and other navigation data to an autopilot or other instrument. An autopilot requires APB, APA and VTG sentences  
For information on sending NMEA data to the instrument, contact Samyung ENC.

During setup to send NMEA data to other instruments, set NMEA out and specify the NMEA data to send.

## 5-7 NMEA 2000

NMEA 2000 interface standard was introduced for communications network to interconnect marine electronic equipments such as navigation chart plotter, engine, tank level sensor and others on vessels. The standard is regulated by The National Marine Electronics Association in USA.

The chart plotter can be connected to external devices with NMEA2000 and display information such as followings.

- Engines have fuel flow sensors, therefore fuel sensors are not required.
- The chart plotter can receive and display wind speed and direction from an optional compatible wind instrument.

- The chart plotter can receive and display depth from an optional depth instruments.
- The chart plotter can receive and display boat speed and water temperature from a paddlewheel sensor on a optional speed instrument.

If connected display unit, use the cable compatible with NMEA 2000 standard.

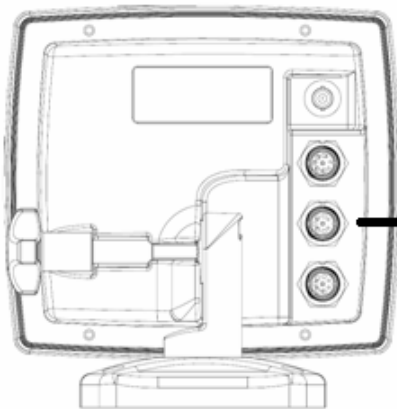

— NMEA 2000

## 5-8 Sonar Transducers

The transducer is a sensor that transmits and receives sound waves into the water.

- Fit the sonar transducer supplied, following the instructions in the Transducer Installation Manual supplied with the chart plotter.
- In case of installation of 50/200KH transducer, water speed sensor and water temperature sensor, an optional through hull dual frequency sonar transducer and through hull speed/temperature transducer provide more enhanced performance. Contact Samyung ENC for more information.
- Connect the transducer to the chart plotter.
- At the system configuration window, set Sonar to  and set up the sonar options

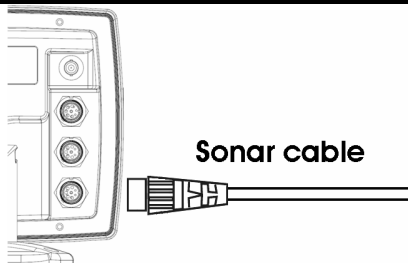

If you use Y-Cable, the chart plotter can display water temperature and water speed from the compatible devices and receive and display the depth from transducer. To connect these instruments, please connect the cable to the unit as the below picture.

Pin number	Detail
1	<b>TD 1</b>
2	<b>Shield</b>
3	
4	
5	<b>TD 2</b>
6	<b>Shield</b>

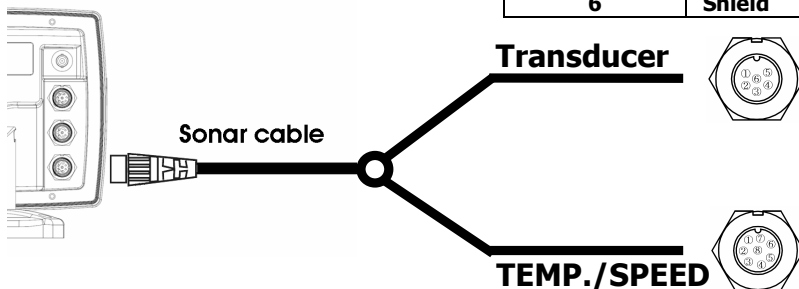

Pin number	Detail
1	<b>Shield</b>
2	<b>Speed supply</b>
3	<b>GND (Shield)</b>
4	<b>TEMP.</b>
5	
6	<b>Speed</b>
7	
8	



## **5-9 Setup and test**

---

- 1 Put a blanking cap on any unused connector on the back of the display unit. Ensure all connectors are plugged in and the display unit is in place.
- 2 If the display unit is bracket mounted, adjust tilt and rotation for best viewing and hand tighten the knob.
- 3 Insert any required C-MAP chart card.
- 4 Enter setup data to set up the chart plotter to your requirements and to set up any optional sensors or instruments.
- 5 At the satellite display, check that it picks up GPS satellites. Wait for the GPS receiver to start up and the GPS satellite to change to 'Used in fix'.



Thank you for purchasing an SAMYUNG ENC product. This product has been thoroughly checked and is covered by the **Samyung ENC's warranty** for defects in materials and workmanship under normal use from the date of purchase.

This warranty provides for the free repair or replacement of defective parts from our Samyung ENC authorized dealer.

In the event that your SAMYUNG ENC product needs service, please return your SAMYUNG ENC product at your expense (shipping and insurance) to your Samyung ENC distributor or SAMYUNG ENC authorized Service Centers. SAMYUNG ENC will, at its discretion, repair or replace any defective products or its components at no cost to you. This is your exclusive remedy for defective products

**Exclusions:** are specifically excluded from warranty;

1. Consumable items, including, but not limited to: fuses, impellers, impeller bearings, impeller shafts are specifically excluded from this warranty. . .
2. All costs associated with transducer replacement, other than the cost of the transducer itself.
3. Routine system checkouts, alignment and calibration, seatrials, unless required by replacement of defective parts.

**Limited warranty:** SAMYUNG ENC will not be responsible for equipment that has been damaged or rendered defective:

1. as a result of incorrect installation, misuse, accident, water damage, abuse or other external causes
2. by modification or service other than by SAMYUNG ENC or authorized distributors, authorized Service Centers. SAMYUNG ENC will not be liable in any event for any consequential or indirect loss or damage. Exceptions are expressly set out in this warranty, SAMYUNG ENC makes no other warranties, express or implied, including any implied warranties of merchantability and fitness for a particular purpose. If any limitation or exclusion of liability in this warranty is invalid and SAMYUNG ENC becomes liable for loss or damage that would otherwise have been excluded, such liability will be limited to the total amount actually paid by you for the product.
3. if the serial number label on the unit has been removed, altered or mutilated



# **SAMYUNG ENC**

[www.samyungenc.com](http://www.samyungenc.com)

 **SAMYUNG ENC Co.,Ltd.**

Head Office : 1123-17, Dongsam-Dong, Youngdo-Gu, Busan, Korea, 606-083 Tel : 82-51-601-5530(Rep.) Fax : 82-51-413-4446  
A/S Center : 65-20, 2-Ga Namhang-Dong, Yungdo-Gu, Busan, Korea, 606-032 Tel : 82-51-601-5570~4(Rep.) Fax : 82-51-416-5515