



INSTRUCTION MANUAL

SURVIVAL CRAFT 2-WAY RADIO  
**IC-GM1600E**

---

---

---

Icom Inc.



---

## RECOMMENDATION

---

**CLEAN THE TRANSCEIVER THOROUGHLY IN A BOWL OF FRESH WATER** after exposure to saltwater, and dry it before operating. Otherwise, the transceiver's keys, switches, and controllers may become unusable, due to salt crystallization, and/or the charging terminals of the battery pack may corrode.

**NOTE:** If the transceiver's waterproof protection appears defective, carefully clean it with a soft, damp (fresh water) cloth, then dry it before operating. The transceiver may lose its waterproof protection if the case, jack cap, or connector cover is cracked or broken, or the transceiver has been dropped. Contact your Icom distributor or your dealer for advice.

---

## DISPOSAL

---



The crossed-out wheeled-bin symbol on your product, literature, or packaging reminds you that in the European Union, all electrical and electronic products, batteries, and accumulators (rechargeable batteries) must be taken to designated collection locations at the end of their working life. Do not dispose of these products as unsorted municipal waste. Dispose of them according to the laws in your area.

---

## PREFACE

---

Thank you for purchasing this Icom transceiver. The IC-GM1600E SURVIVAL CRAFT 2-WAY RADIO is designed and built with Icom's state of the art technology and craftsmanship. With proper care this product should provide you with years of trouble-free operation.

---

## IMPORTANT

---

**READ ALL INSTRUCTIONS** carefully and completely before using the transceiver.

**SAVE THIS INSTRUCTION MANUAL**—This instruction manual contains important operating instructions for the IC-GM1600E.

---

## EXPLICIT DEFINITIONS

---

WORD	DEFINITION
<b>⚠ DANGER!</b>	Personal death, serious injury or an explosion may occur.
<b>⚠ WARNING!</b>	Personal injury, fire hazard or electric shock may occur.
<b>CAUTION</b>	Equipment damage may occur.
<b>NOTE</b>	If disregarded, inconvenience only. No risk of personal injury, fire or electric shock.

---

# TABLE OF CONTENTS

---

RECOMMENDATION .....	i
DISPOSAL .....	i
PREFACE .....	i
IMPORTANT .....	i
EXPLICIT DEFINITIONS .....	i
PRECAUTION .....	iii
<b>1 OPERATING RULES .....</b>	<b>1</b>
<b>2 SUPPLIED ACCESSORIES AND ATTACHMENTS.....</b>	<b>2-3</b>
■ Supplied accessories .....	2
■ Attachments .....	2
<b>3 PANEL DESCRIPTION .....</b>	<b>4-6</b>
■ Front, top and side panels.....	4
■ Function display .....	5
<b>4 BASIC OPERATION .....</b>	<b>7-10</b>
■ Channel selection .....	7
■ Receiving and transmitting .....	8
■ Call channel programming .....	9
■ Adjusting the squelch level .....	9
■ Lock function .....	10
■ Signal strength indicator function .....	10
■ Monitor function .....	10
■ VOX function (FOR ON-BOARD USE ONLY) .....	10
<b>5 SET MODE .....</b>	<b>11-14</b>
■ SET mode programming .....	11
■ SET mode items .....	12
<b>6 BP-234 LITHIUM BATTERY PACK .....</b>	<b>15</b>

<b>7 BATTERY CHARGING (FOR ON-BOARD USE ONLY) ....</b>	<b>16-19</b>
■ Important! .....	16
■ Battery cautions .....	16
■ Battery charging .....	18
<b>8 SURVIVAL CHANNEL LIST .....</b>	<b>20</b>
<b>9 TROUBLESHOOTING .....</b>	<b>21</b>
<b>10 SPECIFICATIONS .....</b>	<b>22</b>
<b>11 QUICK REFERENCE .....</b>	<b>23</b>
<b>12 OPTIONS .....</b>	<b>24-25</b>

Icom is not responsible for the destruction or damage to the Icom transceiver, if the malfunction is because of:

- Force majeure, including, but not limited to, fires, earthquakes, storms, floods, lightnings, or other natural disasters, disturbances, riots, war, or radioactive contamination.
- The use of Icom transceiver with any equipment that is not manufactured or approved by Icom.



---

## PRECAUTION

---

**⚠ DANGER! NEVER** short terminals (or charging terminals) of the battery pack. Also, current may flow into nearby metal objects such as a key, so be careful when placing the battery packs (or the transceiver) in handbags, and so on. Simply carrying with or placing near metal objects such as a key, and so on may cause shorting. This may damage not only the battery pack, but also the transceiver.

**⚠ WARNING! NEVER** connect the transceiver to an AC outlet. This may pose a fire hazard or result in an electric shock.

**⚠ WARNING! NEVER** hold the transceiver so that the antenna is closer than 2.5 cm from exposed parts of the body, especially the face or eyes, while transmitting. The transceiver will perform best if the microphone is 5 to 10 cm away from the lips and the transceiver is vertical.

**NEVER** connect the transceiver to a power source other than the BP-234, BP-224\* or BP-252. Such a connection will ruin the transceiver.

\* China version only

**DO NOT** use or place the transceiver in direct sunlight or in areas with temperatures below  $-20^{\circ}\text{C}$  or above  $+55^{\circ}\text{C}$ .

Icom, Icom Inc. and the Icom logo are registered trademarks of Icom Incorporated (Japan) in Japan, the United States, the United Kingdom, Germany, France, Spain, Russia, Australia, New Zealand, and/or other countries.

**KEEP** the transceiver out of the reach of children.

**KEEP** the transceiver at least 0.9 meters away from your vessel's magnetic navigation compass.

**MAKE SURE** the flexible antenna and battery pack are securely attached to the transceiver, and that the antenna and battery pack are dry before attachment. Exposing the inside of the transceiver to water will result in serious damage to the transceiver.

**BE CAREFUL!** The IC-GM1600E employs waterproof construction, which corresponds to IMO resolution MSC.149 (77) (1 m depth for 5 minutes). However, once the transceiver has been dropped, waterproofing cannot be guaranteed because of possible damage to the transceiver's case or the waterproof seal.

### NOTE:

- According to IMO resolution MSC. 149 (77) (adopted on 3 June 2003), the following regulation has been executed.
- "The equipment should have provisions for its attachment to the clothing of the user and also be provided with a wrist or neckstrap. For safety reasons, the strap should include a suitable weak link to prevent the bearer from being ensnared."
- Instead of the handstrap, a neckstrap is supplied with the equipment on or after 1st July, 2005.

## ◇ **Priorities**

- Read all rules and regulations pertaining to priorities and keep an up-to-date copy handy. Safety and distress calls take priority over all others.
- You must monitor Channel 16 when you are not operating on another channel.
- False or fraudulent distress calls are prohibited under law.

## ◇ **Privacy**

- Information overheard but not intended for you cannot lawfully be used in any way.
- Indecent or profane language is prohibited.

## ◇ **Transceiver licenses**

### **(1) SHIP STATION LICENSE**

When your craft is equipped with a VHF FM transceiver, you must have a current transceiver station license before using the transceiver. It is unlawful to operate a ship station which is not licensed.

Inquire through your dealer or the appropriate government agency for a Ship-Radiotelephone license. This license includes the call sign which is your craft's identification for transceiver purposes.

### **(2) OPERATOR'S LICENSE**

A restricted Radiotelephone Operator Permit is the license most often held by small vessel transceiver operators when a transceiver is not required for safety purposes.

The Restricted Radiotelephone Operator Permit must be posted near the transceiver or be kept with the operator. Only a licensed transceiver operator may operate a transceiver.

However, non-licensed individuals may talk over a transceiver if a licensed operator starts, supervises, ends the call and makes the necessary log entries.

A current copy of the applicable government rules and regulations is only required to be on hand for vessels in which a transceiver is compulsory. However, even if you are not required to have these on hand it is your responsibility to be thoroughly acquainted with all pertinent rules and regulations.

## ■ Supplied accessories

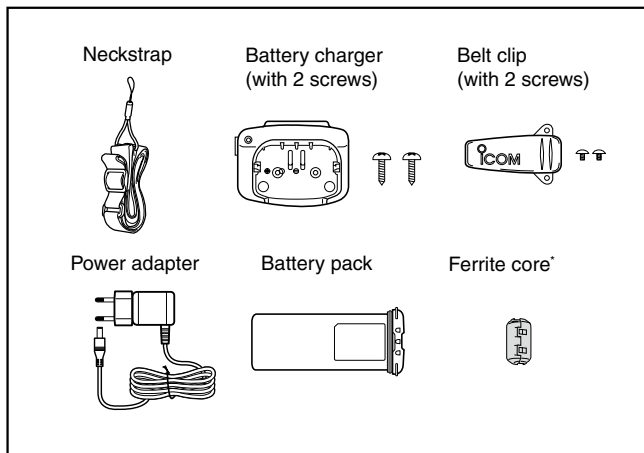

\* Attach the ferrite core to the power adapter before charging.

See page 16 for details.

## ■ Attachments

### ◇ Neckstrap

To attach the neckstrap, pass the neckstrap through the loop on the top of the transceiver as illustrated at right.

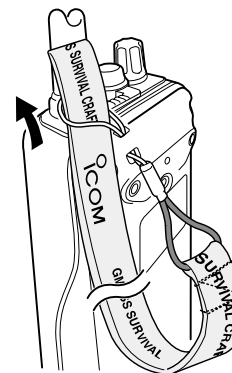

### ◇ Belt clip

Attach the belt clip to the transceiver as illustrated below.

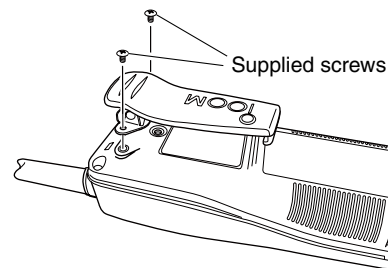

## ◇ Battery pack

*To remove the battery pack:*

Turn the screw counterclockwise, then pull the battery pack in the direction of the arrow as shown below.

*To attach the battery pack:*

Insert the battery pack in the IC-GM1600E completely, then turn the screw clockwise.

**NEVER** remove or insert the battery pack when the transceiver is wet or soiled. This may result water or dust getting into the transceiver/the battery pack and may result in the transceiver being damaged.

**NOTE:** When the lock screw does not easily (feels tight), check to ensure the battery pack is sufficiently inserted to the transceiver. **DO NOT** bang or cause high impact to the battery pack, as this may damage the battery pack/or the transceiver.

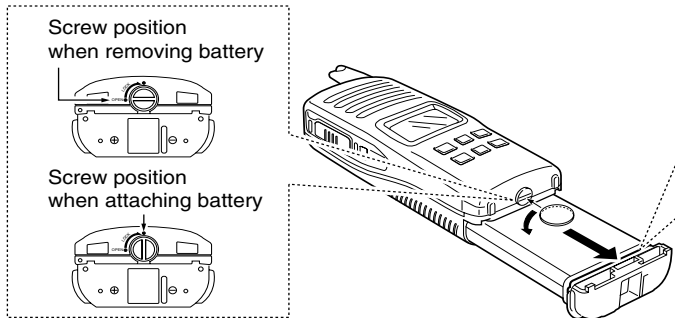

**NOTE:** When removing or attaching the battery pack, use a coin or flat-blade screwdriver to loosen or tighten the bottom screw.

**CAUTION:** When attaching or removing a battery pack, make sure the rubber seal is set in the groove of the battery pack correctly. If the seal is not neatly in the groove it may be damaged when attaching the battery pack. If the seal is damaged, waterproofing is not guaranteed.

**NOTE:** When attaching a battery pack, make sure dust or else does not adhere to the rubber seal. If dust or else is on the seal when attaching a battery pack, the water resistant may be reduced.

Make sure both the rubber seal (purple) is set to the groove correctly and dust or else does not adhere to it.

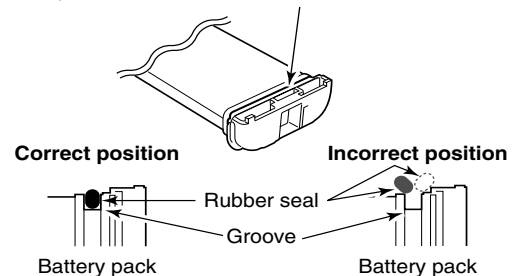

## ■ Front, top and side panels

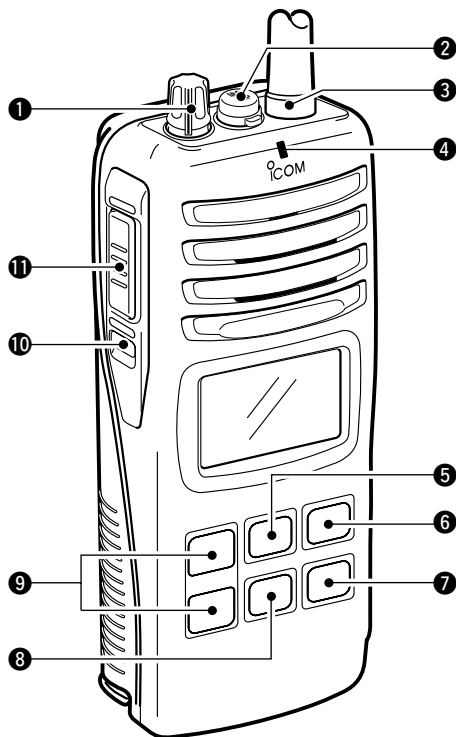

### ① VOLUME CONTROL [VOL]

Turns power ON and adjusts the audio level.

### ② MICROPHONE CONNECTOR [MIC/SP]

Connects the optional external microphone.

**NOTE:** Attach the [MIC/SP] cap when the optional speaker-microphone is not used.

### ③ ANTENNA

Fixed type.

### ④ TRANSMIT/RECEIVE INDICATOR

Lights green while receiving a signal or when the squelch is open, and lights red while transmitting (lights orange while VOX function is used).

### ⑤ CALL CHANNEL SWITCH [CALL]

- ➔ Selects the call channel when pushed. (p. 7)
- ➔ Push for 3 seconds to enter call channel programming condition. (p. 9)

### ⑥ CHANNEL SWITCH [CH]

Push to return the previous condition when priority channel or call channel is selected. (p. 7)

### ⑦ TRANSMIT POWER/LOCK SWITCH [Hi/Lo] [ ]

- ➔ Selects high or low power when pushed. (p. 8)
- ➔ Toggles the lock function ON/OFF when pushed for 1 second. (p. 10)



- 8 CHANNEL 16 SWITCH [16]**  
 Selects Channel 16 when pushed. (p. 7)
- 9 CHANNEL UP/DOWN SWITCHES [▲]/[▼]**

  - ➔ Selects an operating channel. (pp. 7–8)
  - ➔ Selects the SET mode condition of the item. (p. 11)
  - ➔ Selects the SET mode item when pushed with [SQL•MONI]. (p. 11)
- 10 SQUELCH SWITCH [SQL•MONI]**

  - ➔ Push this switch, then adjust the squelch level with [▲]/[▼]. (p. 9)
  - ➔ Manually opens the squelch for monitoring the channel while pushed and held. (p. 10)
  - ➔ While pushing this switch, turn power ON to enter the set mode. (p. 11)
- 11 PTT SWITCH [PTT]**  
 Hold down to transmit; release to receive.

## ■ Function display

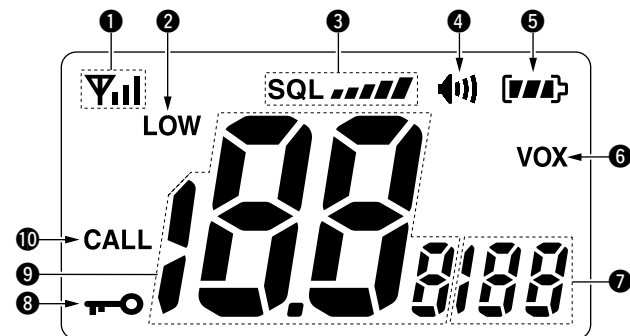

- 1 SIGNAL STRENGTH INDICATOR** (pp. 10, 13)  
 Shows the relative signal strength while receiving signals.
- 2 TRANSMIT POWER INDICATOR** (p. 8)

  - ➔ “LOW” appears when low power is selected.
  - ➔ No indication appears when high power is selected.
- 3 SQUELCH LEVEL INDICATOR** (p. 9)  
 Show the squelch level.
- 4 MONITOR INDICATOR** (p. 10)  
 Appears when the monitor function is activated.

### 3 PANEL DESCRIPTION

#### 5 BATTERY INDICATOR

Indicates remaining battery power.

##### • Using rechargeable battery pack

Indication				
Battery level	Full	Middle	Charging required	No battery

blinks when the battery is over charged.

##### • Using BP-234 battery pack

Indication				
Battery level	Full	Middle	A new battery pack is required	No battery

#### 6 VOX INDICATOR

“VOX” appears when the VOX function is used. (p. 10)

#### 7 SET MODE ITEM READOUT

Indicates the SET mode item while in the SET mode. (p. 11)

#### 8 LOCK INDICATOR

Appears when the lock function is activated. (p. 10)

#### 9 CHANNEL NUMBER READOUT

- ➔ Indicates the selected operating channel number.
- ➔ In SET mode, indicates the selected condition.

#### 10 CALL CHANNEL INDICATOR

Appears when the call channel is selected. (p. 7)

**NOTE:** The backlight is ON at all times.

## ■ Channel selection

### ◇ Channel 16

Channel 16 (Distress channel) is used for establishing initial contact with another station and for emergency communications. While standing by, you must monitor Channel 16.

- ① Push [16] to select Channel 16.
- ② Push [CH] to return to the condition before selecting Channel 16, or push [▲]/[▼] to select the operating channel.

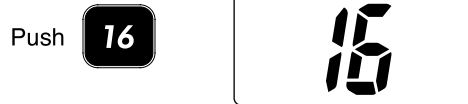

### ◇ Call channel

The call channels can be re-programmed (p. 9) and may be used to store your most often used channels for quick recall.

- ① Push [CALL] to select the call channel.
  - “CALL” and the call channel number appear.
  - Call channel can be re-programmed. See the “Call channel programming” on p. 9 for details.
- ② Push [CH] to return to the condition before selecting the call channel, or push [▲]/[▼] to select the operating channel.

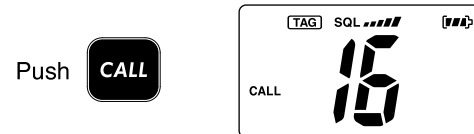

## 4 BASIC OPERATION

### ■ Receiving and transmitting

**CAUTION:** Transmitting without an antenna may damage the transceiver.

- ① Rotate [VOL] clockwise to turn power ON.
- ② Set the volume and squelch level.
  - Push [SQL•MONI], and push [▼] to open the squelch.
  - Push [SQL•MONI] to stop “SQL” indicator blinking, then rotate [VOL] to set the volume level.
  - Push [SQL•MONI], and push [▲]/[▼] to set the squelch level.
- ③ Push [▲]/[▼] to select the desired channel.
  - When receiving a signal, the [TRANSMIT/RECEIVE] indicator lights green while audio is emitted from the speaker.
  - Further adjustment of [VOL] may be necessary at this point.
- ④ Push [Hi/Low] to select the output power if necessary.
  - “LOW” appears when low power is selected; no indication when high power is selected.
  - Choose low power to conserve battery power, choose high power for longer distance communications.
- ⑤ Hold down [PTT] to transmit, then speak into the microphone.
  - The [TRANSMIT/RECEIVE] indicator lights red while transmitting.
- ⑥ Release [PTT] to receive.

**IMPORTANT:** To maximize the readability of your transmitted signal, pause a few seconds after pushing [PTT], hold the microphone 5 to 10 cm from your mouth and speak into the microphone at a normal voice level.

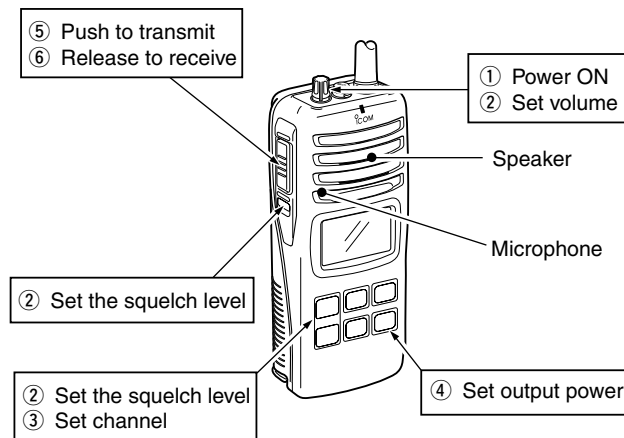

## ■ Call channel programming

The call channel switch is used to select the default channel, however, you can program your most often-used channel for quick recall.

- ① Push [CALL] to select the call channel.
  - “CALL” and call channel number appear.



- ② Push [CALL] again for 3 seconds (until a long beep changes to 2 short beeps) to enter call channel programming condition.
  - Call channel number to be programmed flashes.

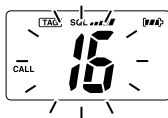

- ③ Push [▲]/[▼] to select the desired channel.

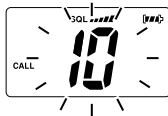

- ④ Push [CALL] to program the displayed channel as the call channel.
  - The call channel number stop flashing.

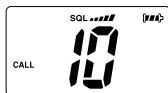

## ■ Adjusting the squelch level

To adjust the IC-GM1600E's squelch level, use the [▲]/[▼] keys as desired below. In order to receive signals properly, the squelch must be adjusted to the proper level.

- ① Push [SQL•MONI], then adjust the squelch level with [▲]/[▼].
  - “SQL” indicator starts blinking.
  - There are 11 squelch levels to choose from: OP is completely open; 10 is tight squelch; 1 is loose squelch level.
  - When no switch is pushed for 5 seconds, the transceiver returns to normal condition.

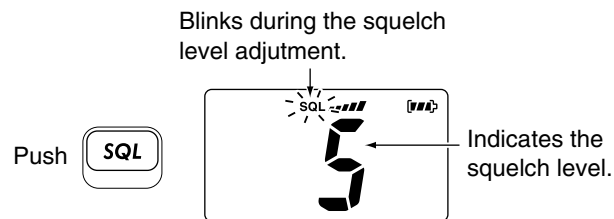

- ② Push [SQL•MONI] again to return to normal condition.

## 4 BASIC OPERATION

### ■ Lock function

This function electronically locks all switches (except for [PTT], [SQL•MONI] and [Hi/Lo•]) to prevent accidental channel changes and function access.

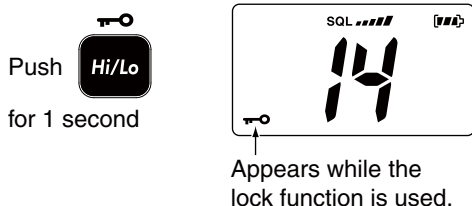

➔ Push [Hi/Lo•] for 1 second to turn the lock function ON and OFF.



### ■ Signal strength indicator function

The received signal strength level is indicated by number of bars as below.

This indicator can be hidden by using the set mode (p. 13) if desired.

Indication				
Signal strength	Strong	Middle	Weak	No signal or very weak

### ■ Monitor function

The monitor function releases the noise squelch mute to check the volume level. See p. 12 for details of the monitor switch action.

➔ Push [SQL•MONI] for 1 second to activate the monitor function.

- “” appears and audio is emitted.

### ■ VOX function (FOR ON-BOARD USE ONLY)

The VOX function (voice operated transmission) starts transmission without pushing [PTT] when you speak into microphone, then automatically returns to receive when you stop speaking (hands-free operation becomes possible).

**NOTE:** An optional headset and optional headset adapter is required for the VOX operation.

➔ Hold down [SQL•MONI], then push [Hi/Lo•] to turn the VOX function ON/OFF while connecting the optional headset and optional headset adapter to the [MIC/SP] connector.

- “VOX” appears on the LCD while the VOX function turns ON.
- The “VOX gain” and “VOX delay” can be set on the SET mode. (p. 14)

## ■ SET mode programming

SET mode is used to change the condition of 9 transceiver functions: Beep tone function, Monitor switch action, LCD contrast selection, Self check function, Battery voltage indicator, Signal strength indicator, Squelch sensitivity function, VOX gain and VOX delay.

### ◇ SET mode operation

- ① Turn power OFF.
- ② While pushing [SQL•MONI], turn power ON to enter the SET mode.
  - "bp" (Beep tone function setting) appears.
- ③ Push [SQL•MONI] or [SQL•MONI] and [▲]/[▼] to select the desired item, if necessary.
- ④ Push [▲]/[▼] to select the desired condition of the item.
- ⑤ Push [16] to exit the SET mode.

4

5

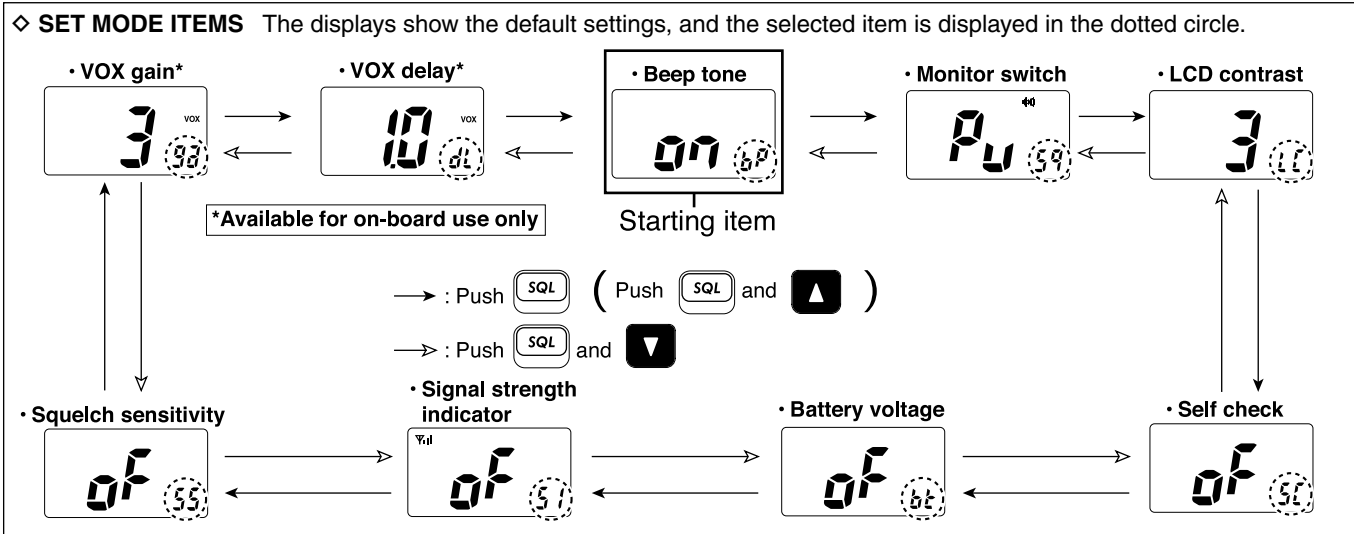

## ■ SET mode items

### ◇ Beep tone function “bP”

You can select silent operation by turning the beep tones OFF, or you can have 2 types of confirmation beeps sound at the push of a switch. When “ON” is selected, a fixed beep (Pi) sounds, and when “US” is selected, the preset beeps (e.g. do, re, mi) sound.

- Beep tone synchronises with the volume level.
- The beeps sound during call channel programming even if this function is turned OFF.

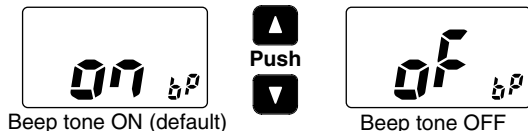

### ◇ Monitor switch action “Sq”

The monitor switch action cuts off the squelch function temporarily. This switch action contains PUSH (Pu) or HOLD (Ho) settings as shown below.

- Pu (PUSH): After pushing [SQL•MONI] for 1 second, the squelch opens and emits audio. The squelch is held open while continuously pushing and holding [SQL•MONI]. (default)
- Ho (HOLD): After pushing [SQL•MONI] for 1 second, the squelch opens and emits audio even [SQL•MONI] is released. To close the squelch, push any switch.

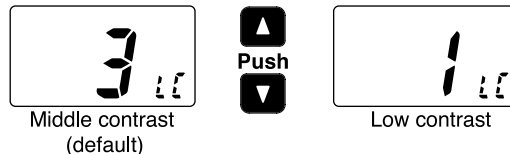

### ◇ LCD contrast selection “LC”

The contrast of the LCD can be adjusted from 4 levels.

- 1 (bright)–4 (dark); 3 (default)

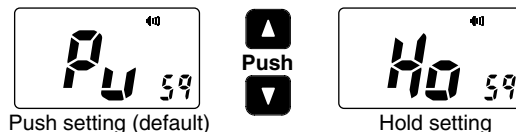



### ◇ Self check function “SC”

The self check function checks the transceiver conditions by itself, and informs you in case a problem is found. Self check automatically and quickly runs through its diagnostic steps each time the transceiver is turned ON. Afterwards, the transceiver switches to normal operation mode.

- Temperature : Outside of  $-35^{\circ}\text{C}$  to  $+80^{\circ}\text{C}$  (approximate)
- Connected battery voltage

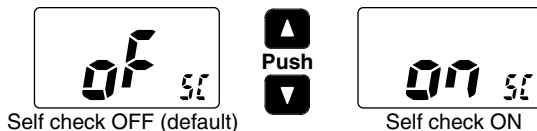

When error messages as shown below are displayed, see troubleshooting for advice. (p. 21)

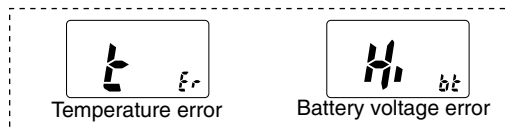

### ◇ Battery voltage indicator “bt”

This function controls display or non-display settings of the connected battery pack’s voltage when the power is ON.

- The voltage of the connected battery pack is displayed for 2 seconds after power is turned ON.

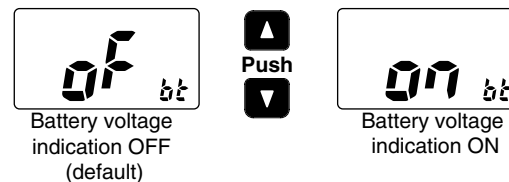

### ◇ Signal strength indicator “SI”

The signal strength indicator displays received signal strength as “S-meter”. This function is convenient to check the signal strength visually.

- The strength is displayed at 4 steps.
- The antenna mark and 3 bars appear when receiving strong signals.
- The antenna mark only appears when receiving no signal.

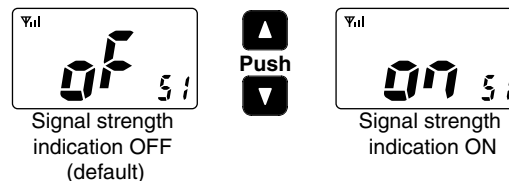

## 5 SET MODE

### ◇ Squelch sensitivity function “SS”

When this function is turned ON, blocking against noise is improved. Therefore the squelch is not easily affected by noise.

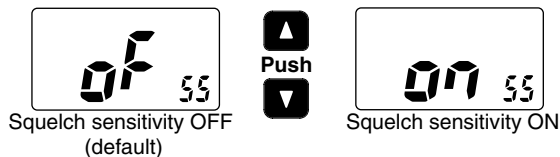

### ◇ VOX gain “ga”

**(Available for on-board use only)**

Adjusts the VOX gain (from 1 to 6) to level when speaking with the optional headset.

- In case of setting to 1, the VOX gain sets to sharpening.
- In case of setting to 6, the VOX gain sets to dulling.

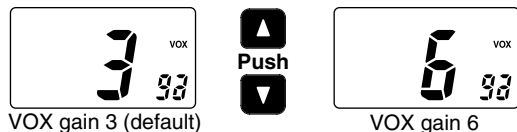

### ◇ VOX delay “dL”

**(Available for on-board use only)**

Sets the VOX delay timer (0.5 to 3.0 seconds in 0.5 second steps) that keeps on transmitting after you stop speaking.

- In case of setting to 0.5, the VOX delay sets to short.
- In case of setting to 3.0, the VOX delay sets to long.

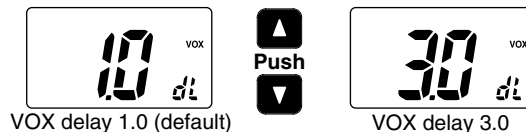

### SET MODE LIST

Function	Indication	Switch
Beep tone function	“bP”	OFF/ON*/US
Monitor switch action	“Sq”	Push*/Hold
LCD contrast selection	“LC”	1/2/3*/4
Self check function	“SC”	OFF*/ON
Battery voltage indicator	“bt”	OFF*/ON
Signal strength indicator	“SI”	OFF*/ON
Squelch sensitivity	“SS”	OFF*/ON
VOX gain	“ga”	1/2/3*/4/5/6
VOX delay	“dL”	0.5/1.0*/1.5/2.0/2.5/3.0

\*default setting

# BP-234 LITHIUM BATTERY PACK

6

The IC-GM1600E is certified as a GMDSS survival craft portable transceiver **ONLY** when used with the BP-234 Lithium battery pack.

For reasons of shelf-life and air cargo regulations, the BP-234 Lithium battery pack is listed as an option but its use in GMDSS applications is mandatory.

Always ensure the sufficient BP-234 Lithium battery packs are available for use in any distress situation and their sealed bag are intact and that their shelf-life has not expired.

The BP-234 Lithium battery pack is not rechargeable and must be replaced after any use.

The following precautions must be observed.

- **⚠ DANGER! KEEP** battery packs away from fire. Fire or heat may cause them to rupture or explode. Dispose of an used battery pack according to local ordinances and/or regulations.
- **DO NOT** short-circuit the BP-234 Lithium battery pack. Metal contact (such as paper clip, another battery, and so on) across the battery contacts can result in a sustained high rate discharge, which could damage the battery, void the warranty and create a burn or a fire hazard.
- **NEVER** expose of the BP-234 Lithium battery pack to excessive heat of 60°C or above. This could result in electrolyte leakage, possibly causing an explosion or fire.
- **NEVER** attempt to recharge the BP-234 Lithium battery pack. Lithium batteries may explode or cause a fire in such cases.

- **DO NOT** disassemble the BP-234 Lithium battery pack. The BP-234 Lithium battery pack contains no user serviceable parts. Internal battery gas can cause throat irritation. Also, exposed lithium may generate heat and ignite.
- **DO NOT** apply excessive pressure to the battery. This may result in electrolyte leakage, possibly causing a explosion or fire.
- The storage life of the BP-234 Lithium battery pack is about 5 years. Once the expiration date on the battery pack expires, a new battery pack **must** be used.
- For safety reasons, once the BP-234 Lithium battery pack is used, a spare one should be purchased. The original battery pack can be continued to be used for regular communications; save the spare one for emergency situations.

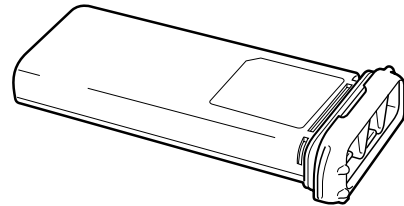

• BP-234 Lithium battery pack

## IMPORTANT:

- This battery pack uses for **EMERGENCY ONLY**.
- Usable temperature range is within  $-20^{\circ}\text{C}$  to  $+55^{\circ}\text{C}$ .
- Stored temperature range is within  $-30^{\circ}\text{C}$  to  $+35^{\circ}\text{C}$ .
- Once this bag's seal is broken, a new emergency battery pack must be used for **EMERGENCY** use.

5

6

## ■ Important!

Attach the supplied ferrite core to the power adapter as follows before charging the battery.

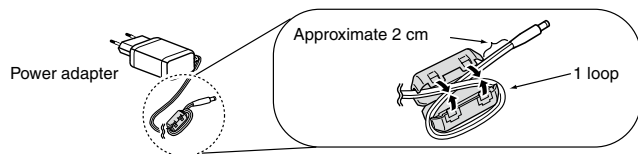

## ■ Battery cautions

### ◇ For the BP-224 (Ni-Cd battery pack) (China version only)

**CAUTION: NEVER** insert battery pack/transceiver (with the battery pack attached) with wet or soiled into the charger. This may result in corrosion of the charger terminals or damage to the charger. The charger is not waterproof and water can easily get into it.

**NEVER** incinerate used battery packs. Internal battery gas may cause an explosion.

**NEVER** immerse battery pack in water. If the battery pack becomes wet, be sure to wipe it dry immediately (particularly the battery terminals BEFORE attaching it to the transceiver).

If your battery pack seem to have no capacity even after being charged, completely discharge it by leaving the power ON overnight. Then, fully charge the battery pack again. If the batteries still do not retain a charge (or very little), new battery pack must be purchased.

### ◇ For the BP-252 (Li-ion battery pack)

Misuse of Li-ion batteries may result in the following hazards: smoke, fire, or the battery may rupture. Misuse can also cause damage to the battery or degradation of battery's performance.

⚠ **DANGER! DO NOT** hammer or otherwise impact the battery. Do not use the battery if it has been severely impacted or dropped, or if the battery has been subjected to heavy pressure. Battery damage may not be visible on the outside of the case. Even if the surface of the battery does not show cracks or any other damage, the cells inside the battery may rupture or catch fire.

⚠ **DANGER! NEVER** use or leave battery pack in areas with temperatures above 60°C. High temperature buildup in the battery, such as could occur near fires or stoves, inside a sun-heated vehicle, or in direct sunlight for long periods of time may cause the battery to rupture or catch fire. Excessive temperatures may also degrade battery's performance or shorten battery life.

⚠ **DANGER! DO NOT** expose the battery to rain, snow, seawater, or any other liquids. Do not charge or use a wet battery. If the battery gets wet, be sure to wipe it dry before using.

⚠ **DANGER! KEEP** battery packs away from fire. Fire or heat may cause them to rupture or explode. Dispose of an used battery pack according to local ordinances and/or regulations.

⚠ **DANGER! NEVER** solder the battery terminals, or modify the battery pack. This may generate heat in the battery, and the battery pack may burst, emit smoke or catch fire.

⚠ **DANGER!** Use the battery only with the transceiver for which it is specified. Never use a battery with any other equipment, or for any purpose that is not specified in the instruction manual.

⚠ **DANGER!** If fluid from inside the battery gets in your eyes, blindness can result. Rinse your eyes with clean water, without rubbing them, and see a doctor immediately.

⚠ **WARNING!** Immediately stop using the battery if it emits an abnormal odor, heats up, or is discolored or deformed. If any of these conditions occur, contact your Icom dealer or distributor.

⚠ **WARNING!** Immediately wash, using clean water, any part of the body that comes into contact with fluid from inside the battery.

⚠ **WARNING! NEVER** put the battery in a microwave oven, high-pressure container, or in an induction heating cooker. This could cause a fire, overheating, or cause the battery to rupture.

**CAUTION:** Always use the battery within the specified temperature range, for the transceiver  $-20^{\circ}\text{C}$  to  $+55^{\circ}\text{C}$  and the battery itself  $-20^{\circ}\text{C}$  to  $+60^{\circ}\text{C}$ . Using the battery out of its specified temperature range will reduce the battery's performance and battery life. Please note that the specified temperature range of the battery may exceed that of the transceiver. In such cases, the transceiver may not work properly because it is out of its operating temperature range.

**CAUTION:** Shorter battery life could occur if the battery is left fully charged, completely discharged, or in an excessive temperature environment (above  $50^{\circ}\text{C}$ ) for an extended period of time. If the battery must be left unused for a long time, it must be detached from the transceiver after discharging. You may use the battery until the remaining capacity is about half, then keep it safely in a cool dry place at the following temperature range:

- $-20^{\circ}\text{C}$  to  $+50^{\circ}\text{C}$  (within a month)
- $-20^{\circ}\text{C}$  to  $+35^{\circ}\text{C}$  (within three months)
- $-20^{\circ}\text{C}$  to  $+20^{\circ}\text{C}$  (within a year)

**BE SURE** to replace the battery pack with a new one approximately five years after manufacturing, even if it still holds a charge. The inside battery material will become weak after a period of time, even with little use. The estimated number of times you can charge the battery is between 300 and 500. Even when the battery appears to be fully charged, the operating time of the transceiver may become short when:

- Approximately five years have passed since the battery was manufactured.
- The battery has been repeatedly charged.

## 7 BATTERY CHARGING (FOR ON-BOARD USE ONLY)

### ■ Battery charging

Prior to using the transceiver for the first time, the battery pack must be fully charged for optimum life and operation.

**CAUTION:** To avoid damage to the transceiver, turn the power OFF while charging.

- Recommended temperature range for charging: BP-224\* is 10°C to 40°C, BP-252 is 0°C to 45°C.
- Use the specified chargers (BC-158\*, BC-173). NEVER use another manufacture's charger.
- Use the supplied power adapter. NEVER use another manufacture's adapters.

\* China version only

Turn OFF the transceiver when charging an attached battery pack. Otherwise, the battery pack may not become full-charging or may not charge properly.

### ◇ Charging cautions

**DANGER! NEVER** charge the battery pack in areas with extremely high temperatures, such as near fires or stoves, inside a sun-heated vehicle, or in direct sunlight. In such environments, the safety/protection circuit in the battery will activate, causing the battery to stop charging.

**WARNING! NEVER** charge the transceiver during a lightning storm. It may result in an electric shock, cause a fire or damage the transceiver. Always disconnect the power adapter before a storm.

**WARNING! NEVER** charge or leave the battery in the battery charger beyond the specified time for charging. If the battery is not completely charged by the specified time, stop charging and remove the battery from the battery charger. Continuing to charge the battery beyond the specified time limit may cause a fire, overheating, or the battery may rupture.

**WARNING! NEVER** insert the transceiver (battery attached to the transceiver) into the charger if it is wet or soiled. This could corrode the battery charger terminals or damage the charger. The charger is not waterproof.

**NOTE:** Charge the battery within the specified temperature range. Otherwise, the charging time will be longer, but the battery will not reach a full charge. While charging, at a point after the temperature goes out of the specified range, the charging will automatically stop.

◇ **Charging connections for BP-224 (China version only)**

- ① Attach the BC-158 to a flat surface, such as a desk.
  - ② Connect the power adapter as shown below.
  - ③ Insert the battery pack with/without the transceiver into the charger.
    - The charge indicator lights green.
  - ④ Charge the battery pack approximately 8 hours, depending on the remaining power condition.
- /// **DO NOT** charge the BP-224 more than 12 hours. Otherwise, the BP-224 will be damaged.

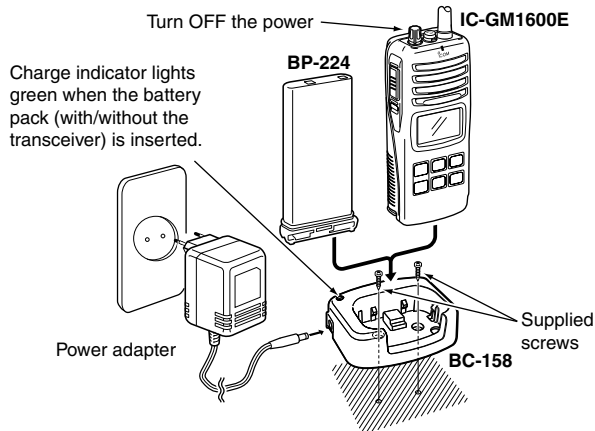

◇ **Changing connections for BP-252**

- ① Attach the supplied ferrite core to the power adapter. (p. 16)
- ② Attach the BC-173 to a flat surface, such as a desk.
- ③ Connect the power adapter as shown right.
- ④ Insert the battery pack with/without the transceiver into the charger.
  - The charger indicator lights orange.
  - The charger indicator blinks orange (or orange/green alternately) when the protector is activated.
- ⑤ Charge the battery pack approximately 10 hours, depending on the remaining power condition.
  - The charger indicator lights green when charging is completed.

/// **NOTE:** The battery charger, BC-173, has a charging timer. The timer stops the charging process after 14 hours (approximate).

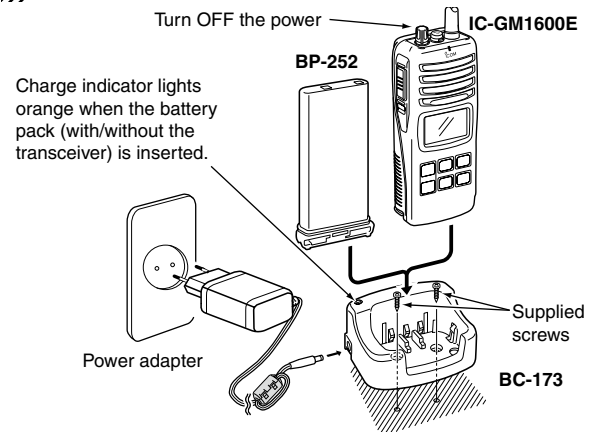



# 8

## SURVIVAL CHANNEL LIST

Channel number	TX/RX	Channel number	TX/RX	Channel number	TX/RX
06	156.300 MHz	08	156.400 MHz	09	156.450 MHz
10	156.500 MHz	11	156.550 MHz	12	156.600 MHz
13	156.650 MHz	14	156.700 MHz	15	156.750 MHz
16	156.800 MHz	17	156.850 MHz	67	156.375 MHz
68	156.425 MHz	69	156.475 MHz	71	156.575 MHz
72	156.625 MHz	73	156.675 MHz	74	156.725 MHz
77	156.875 MHz				



PROBLEM	POSSIBLE CAUSE	SOLUTION	REF.
The transceiver does not turn ON.	The battery is exhausted.	<ul style="list-style-type: none"> <li>• Change the new battery pack (Survival).</li> <li>• Recharge the battery pack (On-board).</li> </ul>	p.15 pp. 16~19
	Bad connection to the battery pack.	Check the connection to the transceiver.	p. 3
No sound from the speaker.	Squelch level is too deep.	Set squelch to the threshold point.	p. 9
	Volume level is too low.	Rotate [VOL] to set a suitable level.	p. 8
	Speaker has been exposed to water.	Drain water from the speaker.	–
	Water has entered to the [MIC/SP] connector.	Dry the [MIC/SP] connector.	–
Transmitting is impossible, or high power can not be selected.	The battery is exhausted.	<ul style="list-style-type: none"> <li>• Change the new battery pack (Survival).</li> <li>• Recharge the battery pack (On-board).</li> </ul>	p.15 pp. 16~19
	The output power is set to low.	Push [Hi/Lo]  to select high power.	p.8
The displayed channel cannot be changed.	Lock function is activated.	Push [Hi/Lo]  for 1 second to cancel the function.	p. 10
No beeps.	Beep tones are turned OFF.	Set the beep tones to ON (Fix Beep/User Beep) on the SET mode.	p. 12
Self check error. (Temperature)	The temperature is outside of –35°C to +80°C (approximate).	Leave the transceiver at room temperature for a while. Turn the power ON to check if the internal temperature has returned to normal.	–
Self check error. (Battery voltage)	The connected battery pack's voltage is more than 11 V.	Verify the battery voltage is correct.	–
Transmitting continuously while not speaking when using VOX function.	Ambient noise is too loud.	<ul style="list-style-type: none"> <li>• Remove the headset cable.</li> <li>• Set the VOX gain to dulling.</li> </ul>	p. 14

# 10 SPECIFICATIONS

## ◇ GENERAL

- Frequency coverage  
TX/RX : 156.300–156.875 MHz
- Mode : 16K0G3E
- Channel spacing : 25 kHz
- Power supply requirement :  
<For Survival craft> BP-234  
<For on-board use> BP-224 (China version only)  
BP-252
- Current drain (at 7.2 V DC) : TX High (2 W) 1.0 A typical  
Maximum audio 200 mA typical
- Useable temperature range : –20°C to +55°C
- Frequency stability : ±1.5 kHz (–20°C to +55°C)
- Antenna impedance : 50 Ω
- Dimensions : 65(W) × 145(H) × 44(D) mm  
(Projections not included)
- Weight (with BP-234) : Approximate 385 g

## ◇ TRANSMITTER

- Output power (at 7.2 V DC) : 2 W (High) and 1 W (Low)
- Modulation system : Variable reactance frequency modulation
- Microphone impedance : 2 kΩ
- Maximum frequency deviation : ±5 kHz
- Adjacent channel power : 70 dB
- Spurious emissions : 0.25 μW (below 1 GHz)  
1 μW (above 1 GHz)

## ◇ RECEIVER

- Receive system : Double-conversion  
superheterodyne
- Sensitivity (20 dB SINAD) : –2 dBμ EMF (typical)
- Squelch sensitivity : 0 dBμ EMF (typical)  
(at threshold)
- Intermodulation rejection ratio : 68 dB
- Spurious response rejection ratio : 70 dB
- Adjacent channel selectivity : 70 dB
- Audio output power : 0.20 W at 10% distortion with  
an 8 Ω load

**NOTE:** Measurements in according to IEC61097-12:1996+Amend1:2017.

**All stated specifications are subject to change without notice or obligation.**

# QUICK REFERENCE 11

Important operating instructions are summed up in this and the following page for your simple reference.

By cutting along the line and folding on the dotted line, it will become a card sized operating guide which can easily be carried in a card case or wallet, and so on.

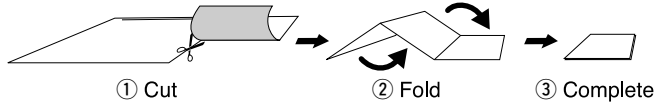

<CUT HERE>

## ICOM OPERATION GUIDE IC-GM1600E

### ■ IN CASE OF EMERGENCY

#### m USING CHANNEL 16

#### DISTRESS CALL PROCEDURE

1. "MAYDAY MAYDAY MAYDAY."
2. "THIS IS (name of vessel)"
3. Your call sign or other indication of the vessel.
4. "LOCATED AT (your position)"
5. The nature of the distress and assistance required.
6. Any other information which might facilitate the rescue.

### ■ CALL CHANNEL PROGRAMMING (p. 9)

- ① Push [CALL] to select the call channel.
  - "CALL" and call channel number appear.
- ② Push [CALL] again for 3 seconds (until long beep changes to 2 short beeps) to enter call channel programming condition.
  - Call channel number to be programmed flashes.
- ③ Push [▲]/[▼] to select the desired channel.
- ④ Push [CALL] to program the displayed channel as the call channel.
  - The call channel number stop flashing.

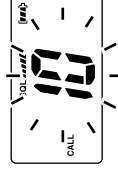
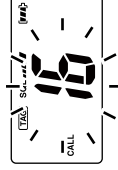

# 11 QUICK REFERENCE

## ■ SET MODE (pp. 11–14)

- ① While pushing [SQL•MONI], turn power ON.
- ② Push [SQL•MONI] again to select an item.
- ③ Push [▲]/[▼] to select the desired condition.
- ④ Push [16] to return to regular operating mode.



Refer to pp. 11–14 for set mode item.

## ■ SET MODE LIST (p. 14)

Function	Indication	Switch
Beep tone function	"bP"	OFF/ON*/US
Monitor switch action	"Sq"	Push*/Hpid
LCD contrast selection	"LC"	1/2/3*/4
Self check function	"SC"	OFF*/ON
Battery voltage indicator	"bV"	OFF*/ON
Signal strength indicator	"Sf"	OFF*/ON
Squelch sensitivity	"SS"	OFF*/ON
VOX gain	"ga"	1/2/3*/4/5/6
VOX delay	"dL"	0.5/1.0*/1.5/2.0/2.5/3.0

\* default setting

## ◇ BATTERY PACKS

### <FOR SURVIVAL CRAFT>

- **BP-234** Lithium battery pack  
Voltage : 9.0 V  
Capacity : 3300 mAh

### <FOR ON-BOARD USE>

#### (China version only)

- **BP-224** Ni-Cd battery pack  
Voltage : 7.2 V  
Capacity : 750 mAh
- **BP-252** Li-ion battery pack  
Voltage : 7.4 V  
Capacity : 950 mAh (minimum) / 980 mAh (typical)

## ◇ BELT CLIPS

- **MB-103Y** BELT CLIP  
The same as supplied with the transceiver.

## ◇ CHARGERS

### <FOR ON-BOARD USE ONLY>

#### (China version only)

- **BC-158** DESKTOP CHARGER + **BC-147S** AC ADAPTER  
Used for regular charging of battery pack. The same as supplied with the transceiver.  
Charging time: Approximate 8 hours.
- **BC-173** DESKTOP CHARGER + **BC-147S** AC ADAPTER  
Used for regular charging of battery pack. The same as supplied with the transceiver.  
Charging time: Approximate 10 hours.

---

# MEMO

---

# MEMO

---

---

---

---

---

---

---

---

---

---

---

---

---

---

---

---

---

---

---

---

---

---

---

---

---

---

---

---

---

---

---

---

**Count on us!**

A6387D-1EU-7  
Printed in Japan  
© 2005–2018 Icom Inc.

Printed on recycled paper with soy ink.

**Icom Inc.**

1-1-32 Kamiminami, Hirano-ku, Osaka 547-0003, Japan