



User Manual



EPIRB1 Pro

Category 1

Emergency Position Indicating Radio Beacon

English

www.oceansignal.com



© 2023 Ocean Signal Ltd

The technical data, information and illustrations contained in this manual were believed to be correct at the time of print. Ocean Signal Ltd reserve the right to change specifications and other information contained in this manual as part of our continual improvement process.

No part of this manual may be reproduced, stored in a retrieval system or transmitted in any form, electronic or otherwise, without the prior permission of Ocean Signal Ltd.

No liability can be accepted for any inaccuracies or omissions in this manual.

Ocean Signal® and rescueME® are registered trademarks of Ocean Signal Ltd.

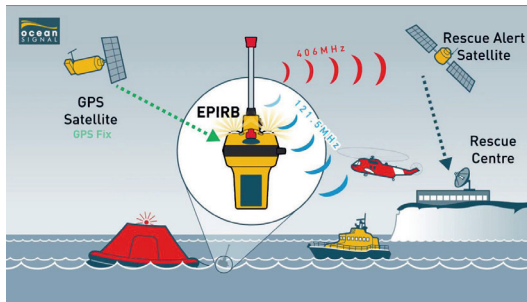

For ease of access please record details of your EPIRB1 Pro here:

Owners Name:

Vessel Name:

Beacon HEX ID (UIN):

IN CASE OF EMERGENCY

USE ONLY IN SITUATIONS OF
GRAVE AND IMMINENT DANGER
MANUAL ACTIVATION



1 Pull the pin

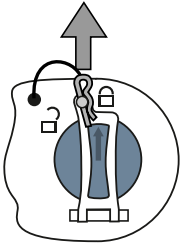

2 Release the catch

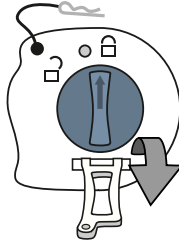

3 Turn the knob

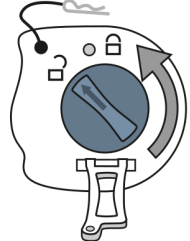

4 Remove the cover

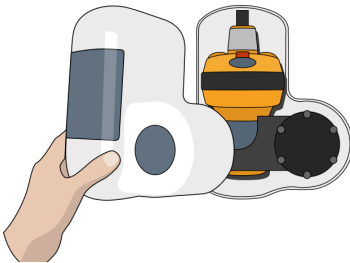

5 Release the EPIRB



6 Break the tab



7 Lift the flap



8 Press the button



1. General	5
1.1 Introduction	5
1.2 Exposure to RF Electromagnetic Energy	5
1.3 What's in the Box	5
1.5 Operating Modes	6
2. EPIRB1 Pro Overview	7
3. Installation	8
3.1 Location	8
3.2 Removing the EPIRB from the Float Free Housing	9
3.3 Loading the EPIRB1 Pro into the housing	12
4. Operation	14
4.1 Manual Activation	15
4.2 Deactivation	17
5. False Alerts	18
6. Testing	18
6.1 Beacon Test	19
6.2 GPS Test	20
6.3 Inspection	21
7. COSPAS/SARSAT System	22
8. Appendix	23
8.1 HRU Replacement	23
8.2 Maintenance and Troubleshooting	24
8.3 Batteries	24
8.4 Transport	24
8.5 Disposal	24
9. Specifications	25
10. Approvals	26
11. Registration	26
12. Optional Accessories	26
13. Warranty Information	27
13.1 Limited Warranty	27
13.2 Extended Warranty	27

1. General

1.1 Introduction









This manual provides valuable information for the installation, operation and routine maintenance of the EPIRB1 Pro complete with the Float Free Housing.

Please read this manual completely before using your EPIRB1 Pro.

1.2 Exposure to RF Electromagnetic Energy

This product complies with EN62479 (EU) at separation distances of 5 mm and 25 mm and with RSS-102 (Canada).

Warnings

-  **It is a legal requirement to register your EPIRB1 Pro with your National Authority.**
-  **Only use your EPIRB1 Pro in a situation of grave and imminent danger.**
-  **Deliberately misusing your EPIRB1 Pro or setting it off accidentally may result in prosecution and a fine.**
-  **Your EPIRB1 Pro contains small lithium batteries.**
-  **Please see section 9.3 for information on safe transportation.**
-  **The battery in your EPIRB1 Pro should be replaced immediately if it has been activated, or if the test indicator shows the battery as 'used', or if the expiry date marked on the unit has been exceeded.**
-  **The EPIRB1 Pro is supplied with an automatic release housing for external installation only. See the installation guidelines in section 2 for further information.**
-  **Please read these instructions carefully. Failure to follow the guidance in this manual may result in loss of warranty.**

1.3 What's in the Box

1. EPIRB
Cat1 Assembly
2. User Guide &
Labels
3. Adapter Bracket
& Mounting Screws

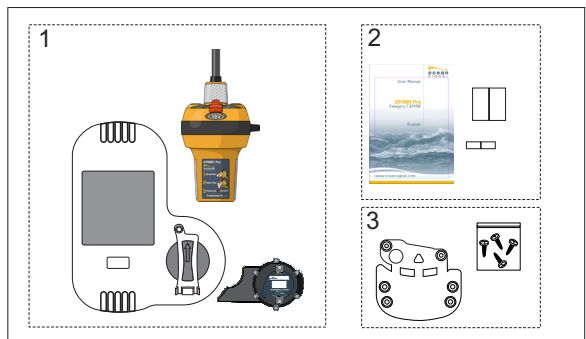

1.5 Operating Modes

Your EPIRB1 Pro may be operated in a variety of modes.

1.5.1 Automatic Release



Should the vessel sink the EPIRB1 Pro will automatically be released from its housing and float to the surface. Contact with the water will automatically activate the EPIRB1 Pro.

1.5.1 Manual activation on deck



When deploying the EPIRB1 Pro on a deck, ensure it is vertical and clear of obstructions that might impede a clear view of the sky. If the unit is thrown into the water then it will activate automatically.

1.5.1 Manual activation in a life raft



The EPIRB1 Pro may be deployed in a life-raft, where it should be held in a vertical position so that there is a clear view of the sky, preferably outside of the canopy.

2. EPIRB1 Pro Overview



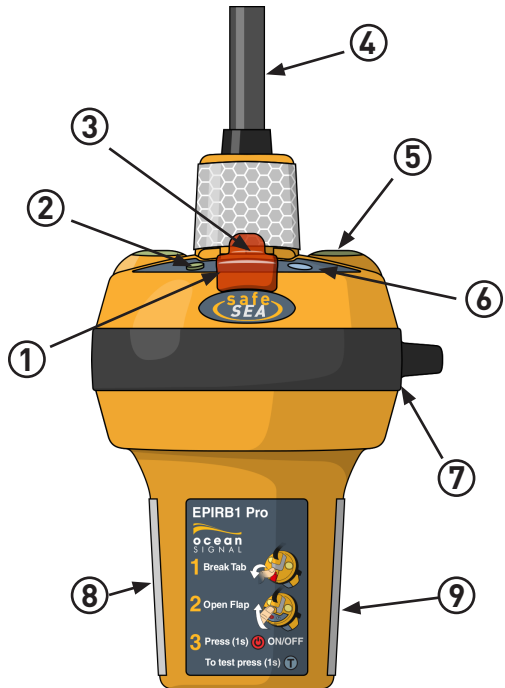

- 1) **ON/OFF** Key (Under flap)
- 2) Indicator LED
- 3) Break Off Tab
- 4) Antenna
- 5) Strobe light
- 6) **TEST** Key
- 7) Lanyard under rubber band
- 8) Serial Number/ UIN Label
- 9) Programming Details Label



! The lanyard is provided to attach the EPIRB1 Pro to the life raft or your person, once it is activated. Do not use it to attach it to the ship, as this may result in the loss of the EPIRB1 Pro if the vessel sinks.

! It is important that the vessel details are marked on the EPIRB1 Pro. Please use a fine tip UV resistant indelible pen to clearly mark the MMSI, Vessel Name and Call Sign in the spaces provided. Cover this label with the clear protective label provided to protect the text from wear.

3. Installation

-  Failure to follow the following installation guidelines may cause the EPIRB1 Pro to operate incorrectly.
-  Do not mount the EPIRB1 Pro closer than 1.0 metre to any steering compass as this may affect the accuracy of the compass.
-  Keep the EPIRB1 Pro away from any strong magnetic sources such as loudspeakers, compass compensation magnets, etc.
-  To prevent possible build up of ice within the Auto Release Housing mount the unit to a vertical surface

3.1 Location

The location selected must be sufficiently robust to support the weight of the entire unit. Exposure to the elements and surrounding hazards along with vibration should also be taken into consideration when choosing the location. Ensure that the mounting location allows easy access to the EPIRB1 Pro for maintenance and servicing.

To ensure that the EPIRB1 Pro will always float free from the sinking vessel ensure that the float free housing is located high up on the superstructure, free from any obstructions and located in a position that it will not be trapped, regardless of the angle the sinking vessel may be in. Always leave at least 150mm (6") around the Float Free Housing to ensure the cover releases reliably.

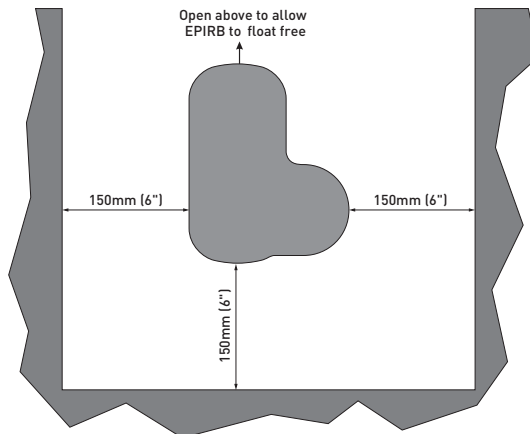

Removing the EPIRB from the Float Free Housing

Prior to installation the EPIRB must be removed from the housing.

1. Remove the pin
2. Release the safety catch from the release knob
3. Turn the knob anti-clockwise to release the cover

①

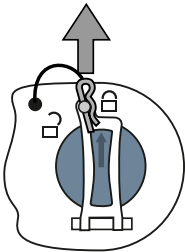

②

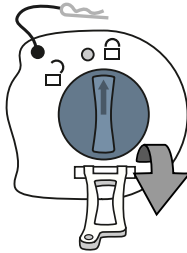

③

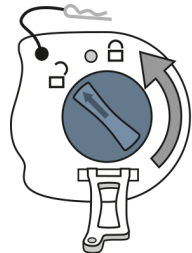

4. Pull the cover free and discard.
5. Lift the Hydrostatic clip and remove the EPIRB1 Pro from the mount

④

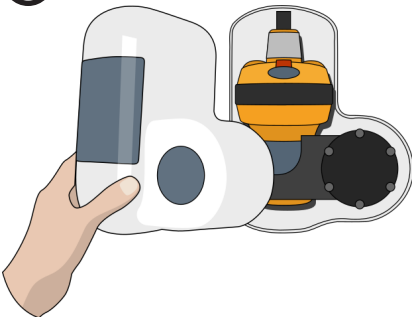

⑤



3.1.1 Fitting the Float Free Housing

Using the dimensions shown, use the four No10 x 1" screws supplied to secure the float free housing to the chosen structure using the holes marked 'O' on the diagram. For mounting surfaces constructed of a material unsuitable for these screws use suitable fixings (not supplied).

Fixing holes 'E' are provided to match the Ocean Signal E100/E100G if this product is being used to replace these older models.

3.1.2 Mounting Dimensions

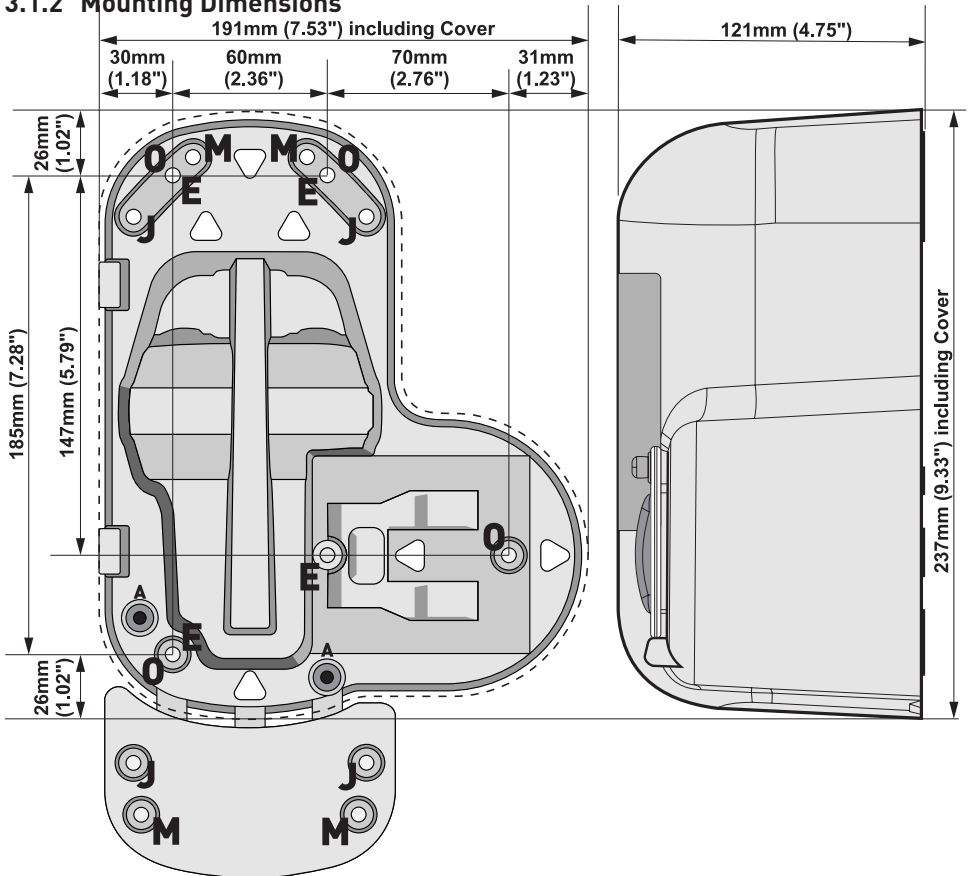

3.1.3 Retro-fit Adapter Bracket

The EPIRB1 Pro Float Free Housing comes with an adapter bracket that allows easy installation where older EPIRBs from other manufacturers have been fitted. Attach the adapter bracket to the Float Free Housing using the two holes 'A' and the self tapping screws provided.

The Adapter bracket provides fixing holes suitable for:

- **J** - Jotron Tron 60S
- **M** - McMurdo E5/G5

3.2 Loading the EPIRB1 Pro into the housing

-  **When replacing the EPIRB1 Pro in the Float Free Housing please ensure that the unit is clean and dry. The area around the activation controls and the lanyard should be free from water and dirt to ensure reliable operation.**

The EPIRB1 Pro is held in place inside the Float Free Housing by the Hydrostatic Release Unit (HRU) which locks into position using a spring.

Following installation (or after maintenance, testing, etc.) it is necessary to replace the EPIRB1 Pro into the Float Free Housing.

1. Pull back the HRU
2. Load the EPIRB1 Pro, controls facing up, into the location seat, ensuring to carefully fold the antenna back behind the EPIRB1 Pro.



3. Gently lower the HRU back into the locked position - this holds the EPIRB1 Pro securely in place.

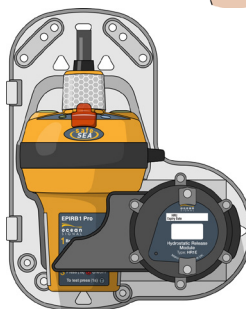

4. Place the housing cover over the back, by placing the locating holes (on the side of the housing) over the clips.

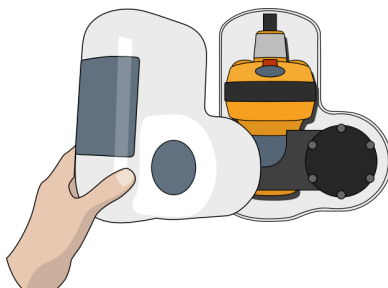

- When installing your EPIRB1 Pro for the first time, the expiry date on the HRU label (shown below) should be completed with an indelible pen .

NOTE: The expiry date should be two years from the date of installation on to your vessel, but no more than three years from the date of manufacture provided.



- Clearly mark the expiry date on to the separate label provided for use on the outside of the Housing.
- Push and rotate the housing release knob into the locked position (right).
- Fold the latch up over the release knob
- Insert the pin to retain the latch

7 Push & Turn the knob

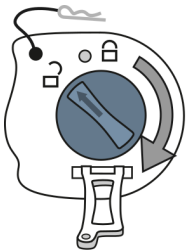

8 Close the catch

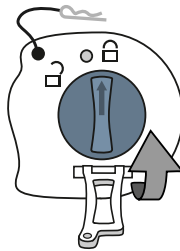

9 Insert the pin

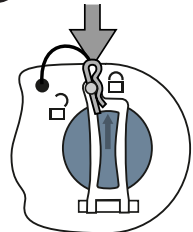

- Complete the provided identification label using a UV stable indelible pen. Fit to the side of the ARH1 Pro cover left hand side in an easily visible position and use the clear protective label to cover it. Fix the HRU Expiry label to the housing in the rectangular recess and cover with the clear protective label.

An activation instruction label is provided and should be positioned close to the installation to assist any member of the crew or passengers in the activation procedure should they need to manually remove and activate the EPIRB1 Pro.



4. Operation

IN CASE OF EMERGENCY



**USE ONLY IN SITUATIONS OF
GRAVE AND IMMINENT DANGER**



The EPIRB1 Pro is designed for best operation while floating in water. If used in other situations ensure that the EPIRB1 Pro is placed in the open, clear of any cover and kept upright. Do not place the EPIRB1 Pro close to large structures or under cover.

In the event the vessel sinks the EPIRB1 Pro will automatically be released from the housing and will activate on contact with the water.

In the case of abandoning ship, if possible, recover the EPIRB1 Pro and tie to the survival craft or person using the lanyard. For optimum operation, it is recommended that the EPIRB1 Pro be tied to the raft with the lanyard and floated in the sea.



The EPIRB1 Pro is prevented from accidental activation while mounted in the Float Free Housing. For manual activation the EPIRB1 Pro MUST be removed from the housing.

4.1 Manual Activation

4.1.1 Removing from the Enclosure

1. Remove the pin
2. Release the safety catch from the release knob
3. Turn the knob anti-clockwise to release the cover

①

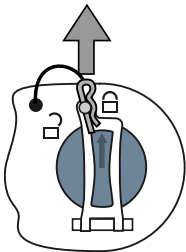

②

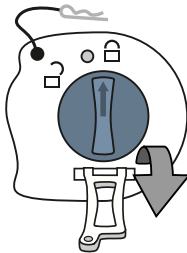

③

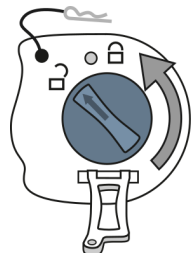

4. Pull the cover free and discard.
5. Lift the Hydrostatic clip and remove the EPIRB1 Pro from the mount

④

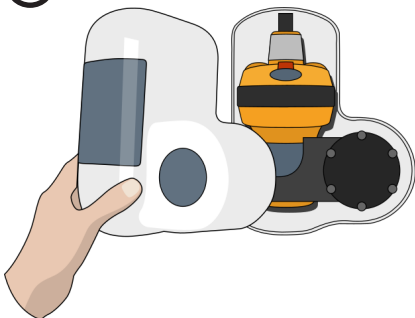

⑤



4.1.2 EPIRB1 Pro Manual Activation

1. Break off the red protective tab from the top of the EPIRB1 Pro.
2. Lift the yellow flap up to expose the Red ON/OFF button.
3. Press and hold the red button for 1 second to activate.
(Until the green LED starts to flash)

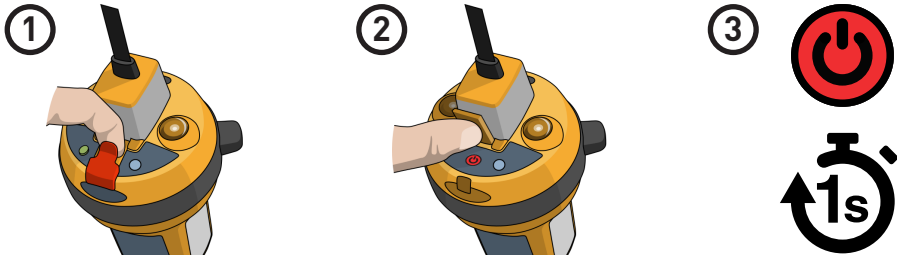

The EPIRB1 Pro will now be operational. The strobe lights will begin to flash at a rate of once every 2.5 seconds as soon as the unit is activated.

For best performance it is important that the EPIRB1 Pro is in an upright position with a clear view of the sky and as far away from any metallic structures as is possible.

The EPIRB1 Pro contains a GPS receiver, ensure that the GPS antenna is not obstructed and has a complete, unobstructed view of the sky – as indicated on the top of the EPIRB1 Pro.

A lanyard is provided to tether the EPIRB1 Pro to the lifeboat or life raft to ensure that it does not drift away. Make sure this is firmly attached.

4.1.3 EPIRB1 Pro Automatic Operation

The EPIRB1 Pro will sense when it has been placed in water and automatically begin to operate after a short delay, in the same manner as described above.

⚠ If the EPIRB1 Pro is mounted in the float free housing this function is disabled until the EPIRB1 Pro has been released.

If the EPIRB1 Pro is mounted in the float free housing in the event that the vessel sinks the EPIRB1 Pro will automatically be ejected from the housing allowing it to float to the surface and begin transmission.

EPIRB Mode	Green Indicator	Red Indicator
Initial EPIRB activation	On for 1 second	
Acquiring GPS position	1 flash every 5 seconds	
GPS position acquired *	3 quick flashes	
121.5MHz Tx		1 flash, with strobe light, every 2.5 seconds
406MHz Tx, with GPS position	5 quick flashes	
406MHz Tx, without valid GPS position		5 quick flashes

Note: The first alert is transmitted after 50 seconds to allow time to deactivate the unit if accidentally turned on . The homing beacon is not activated until the first 406MHz alert is sent.

4.2 Deactivation

4.2.1 Deactivation if Manually Activated

If the EPIRB1 Pro has been inadvertently activated or the emergency situation has passed, it can be turned off simply by pressing and holding for 2 seconds the ON/OFF  key. It is not possible for the user to replace the red protective cover. Return the EPIRB1 Pro to an Ocean Signal authorised service centre for checking and replacement.

4.2.2 Deactivation if Automatically Activated

If the EPIRB1 Pro was automatically activated by placing in water, remove from the water and dry. The EPIRB1 Pro will automatically switch off after approximately 30 seconds.

Should the EPIRB1 Pro fail to deactivate, bend the antenna down and completely wrap in several layers of aluminium foil , or place in a metal container with a tight fitting lid.

5. False Alerts

False alerts are a serious problem - they cause valuable resources to be diverted away from real emergency situations. If a false alert is initiated, by any means, it is important to contact the nearest search and rescue authority and inform them of the false alert.

Report the following information:

1. EPIRB1 Pro Hex ID.
2. Date, time and duration.
3. Cause of activation.
4. Location when the alert was activated.
5. Location at time of deactivation.

If the EPIRB1 Pro was activated by mistake then turn it off. The first emergency transmission will not occur for approximately 50 seconds, if the unit is turned off within this time then EPIRB1 Pro will not have sent an emergency distress.

The EPIRB1 Pro is fitted with water activation contacts. Although the float free housing is designed to prevent accidental activation in heavy seas and adverse weather conditions, if the EPIRB1 Pro is not correctly fitted in its housing it is possible that this may cause a false alert situation

If the unit has been dropped into the water then remove from the water and dry the case, wait approximately 30 seconds for the water contacts to de-activate. If the unit is still flashing after this period, check that the unit has not been manually activated; if so then follow the procedure to manually switch the EPIRB1 Pro off.





Once EPIRB1 Pro is switched off, it is advisable to carry out a self test before replacing the EPIRB1 Pro into the float free housing.

Should the EPIRB1 Pro fail to deactivate, bend the antenna down and completely wrap in several layers of aluminium foil , or place in a metal container with a tight fitting lid.

6. Testing

Routine testing of your EPIRB1 Pro is recommended to ensure it is in good working order if needed in an emergency. Monthly testing is recommended, but remember that each test will reduce the battery capacity slightly and reduce the operating time of your EPIRB1 Pro during an emergency.

6.1 Beacon Test

-  **Ensure the antenna is free and above the EPIRB1 Pro before commencing the test. Fold the antenna back behind the EPIRB1 Pro as you replace it in the housing.**
-  **Because the test transmits a short burst on the aircraft distress frequency of 121.5MHz, please only carry out this test in the first five minutes of each hour.**
-  **It is recommended to test your EPIRB1 Pro once a month.**
-  **The amber test result indicates the battery has been used for over one hour or the recommended number of tests has been exceeded. The EPIRB1 Pro will still operate normally in distress, but the battery should be replaced to ensure the full operating life when your EPIRB1 Pro is needed.**

To test your EPIRB1 Pro is functioning correctly, press and hold the TEST key for at least one second. The red LED will come on to indicate the switch is depressed, followed by the red LED flashing rapidly, indicating test mode is activated. The switch may now be released. The strobe light will flash once (indicating that the 406 and 121.5MHz signal has been transmitted).



After a short pause, the indicator LED will produce a flash sequence:

Green/Amber Indicator		Red Indicator Status
No. of Flashes	Test Passed No. of Hours Used	Failure Type
1 Flash	0 to 1hr (Green)	121.5MHz homer
	1 to 2hrs (Amber)	
2 Flashes	2 to 4hrs (Amber)	406MHz generation
3 Flashes	4 to 6hrs (Amber)	406MHz power
4 Flashes	6 to 8hrs (Amber)	Faulty battery
5 Flashes	8 to 10hrs (Amber)	Other failure
6 Flashes	Over 10hrs (Amber)	

-  **This flash sequence is repeated a second time after a short delay and then the EPIRB1 Pro will automatically turn off.**

The number of green/amber flashes in each group indicates the number of hours the battery has been used for as shown in the table.

6.2 GPS Test

-  **As testing the GPS receiver expends significant amounts of battery energy, do not test the GPS operation more than once a year. Testing the GPS receiver is limited to 12 tests over the lifetime of the battery, after this the GPS test will fail to activate.**
-  **This test must only be performed where the EPIRB1 Pro has a clear and unobstructed view of the sky. This is required to allow the GPS receiver to acquire a signal from sufficient satellites to allow it to determine a position. Make sure the area marked 'GPS Antenna' is not obstructed.**

Press and hold the **TEST** key. The LED will illuminate red to indicate the key has been pressed, then start flashing. After approximately ten seconds the LED will cease flashing and become a steady red light.

The **TEST** key can now be released.

Note: If the **TEST** key is released before ten seconds, the EPIRB1 Pro will enter the beacon test mode.

During the GPS test the LED will repeat a long red flash followed by a short green flash until either a position fix is obtained or the GPS test fails.

A successful test will be indicated by the strobe flashing and the green LED flashing. The number of green flashes indicates one more than the number of GPS tests remaining (e.g. 8 flashes = 7 tests remaining). The unit automatically turns off after the test indication.

If after five minutes the GPS receiver has not received a position, a failure will be indicated by the red LED flashing after which the unit will turn off.

The test can be ended at any time by holding the ON key for one second or by holding the **TEST** key for five seconds.

6.3 Inspection

During the monthly EPIRB self test it is advised that the following inspection is performed.

- Inspect the EPIRB for obvious signs of damage – including the state of the antenna. Any creases in the antenna may cause the operation of the EPIRB to be impaired.
- Confirm that the EPIRB is securely mounted on the bracket or in the float free housing.
- Inspect the lanyard to ensure it is not attached to any structures.
- Confirm the battery is within the specified expiry date.
- Confirm the HRU is within the specified expiry date (Two years after the installation date).
- Clean the EPIRB and mounting, it is recommended that the EPIRB is cleaned only using a damp cloth.

There are no user serviceable parts inside the EPIRB.



DO NOT OPEN THE EPIRB, DOING SO WILL INVALIDATE THE WARRANTY AND MAY CAUSE FALSE ALERTS

7. COSPAS/SARSAT System

The COSPAS/SARSAT system utilises two satellite arrays to provide distress alert and location data to search and rescue authorities:

- The GEOSAR system can provide near immediate alerting within the coverage of the receiving satellite.
- The LEOSAR system provides coverage of the polar region beyond the range of the GEOSAR system.

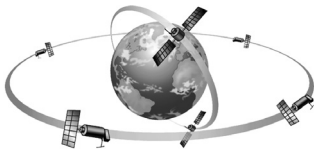

It can calculate the location of distress events using Doppler processing techniques and is less susceptible to obstructions which could block a signal in a given direction. The system is comprised of instruments on board the satellites which detect the signals from the distress beacons. Ground receiving stations, referred to as

Local Users Terminals (LUTs) receive and process the satellite downlink signal to generate the distress alerts. The distress alerts, generated by the LUTs, are then received by Mission Control Centres (MCCs) which then forward the alert to Rescue Co-ordination Centres (RCCs), Search and Rescue Points of Contacts (SPOCs) and other MCCs.

8. Appendix

8.1 HRU Replacement

The EPIRB1 Pro is mounted in a float free housing, this contains a HR1E Hydrostatic Release Unit (HRU). The HRU unit must be replaced two years after installation - the expiry date is marked on the HRU and on the front of the housing.

If this date has been reached then the HRU must be replaced with an Ocean Signal HR1E, failure to do so may result in the HRU not operating correctly during an emergency situation.

Lift the release mechanism by pulling against the spring and remove the EPIRB from the housing.

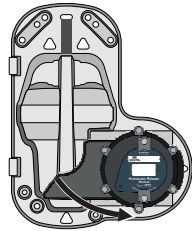

Push the HRU down against the spring and remove the locking pin. Carefully remove the HRU from the spring.

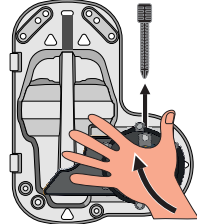

Using the new HRU, locate the two retaining ridges (at the bottom of the HRU) onto the spring. Carefully push the HRU against the spring.

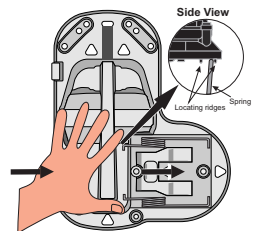

Push the HRU into position as shown. Push the locking pin home with the retaining flange pointing down. Load the EPIRB into the housing.

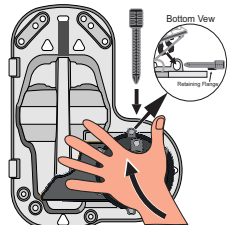

8.2 Maintenance and Troubleshooting

Your EPIRB1 Pro will require little maintenance except periodic cleaning, if required. Always use a damp cloth to clean the case and dry thoroughly. Do not use solvents or other cleaning fluids as this may cause the plastics to deteriorate.



There are no user serviceable parts inside the EPIRB1 Pro

8.3 Batteries

The EPIRB1 Pro contains Lithium batteries for long operating life. Your battery must be replaced either after the expiry date or after the EPIRB1 Pro has been activated, even if only for a short period of time. Battery replacement must be done at an Ocean Signal authorised battery replacement centre.

All Lithium batteries self discharge slowly over time at a rate that is related to temperature. Maximum performance of the battery is achieved with long term storage at an average temperature of no greater than 20°C.

8.4 Transport

When shipping your EPIRB1 Pro the following guidance and regulations should be followed, but you are advised to contact your nearest battery replacement centre or Ocean Signal prior to shipping as regulations may have changed.

- Always pack your EPIRB1 Pro securely in a stout cardboard carton. Ocean Signal advises that you keep the original packaging in case of return for service.
- For surface transport the EPIRB1 Pro may be shipped under special provision 188.
- For air transport the EPIRB1 Pro should be shipped as category UN3091 and packed under IATA packing instruction 970 section II. If you are hand carrying your EPIRB1 Pro on an aircraft please contact your airline for advice

8.5 Disposal

Care should be taken when disposing of your EPIRB1 Pro when it is no longer required. It is recommended to remove the battery from the EPIRB by removing the case lid. The case screws are covered by the top label. Dispose of the battery in accordance with local waste regulations. Please note that the EPIRB1 Pro is not user serviceable and removing the lid will invalidate the warranty.

9. Specifications

406MHz Transmitter

Frequency	406.040 MHz \pm 1KHz
Output Power	12W EIRP
Modulation	Phase \pm 1.1 Radians Pk (16K0G1D)
Encoding	Biphase L
Rate	400 bps

121.5MHz Transmitter

Frequency	121.5 MHz
Output Power	40mW \pm 2dB
Modulation	Swept Tone AM (3K20A3X)
Modulation Depth	~97%
Frequency Stability	\pm 50ppm
Duty Cycle	~35%

Low Duty Cycle Strobe

Light Type	Dual High Intensity LED
Flash Rate	20-30 per minute

Battery

Type	Lithium Manganese Dioxide (LiMnO ₂)
Operating Time	>48Hours @ -20°C
Battery Replacement Period	10 years

GPS Receiver

Satellite Channels	66 (Acquisition)
Sensitivity	-148dBm
Cold Start Re-acquisition	-163dBm
GPS Antenna	Microstrip Patch

NFC Transmitter/Receiver

Operating Frequency	13.56 MHz
---------------------	-----------

General

Dimensions of Float Free Housing	237mm x 191mm x 121mm (9.3" x 7.5" x 4.8")
Weight	422grams (14.9oz)
IEC60945 Category	Portable
Operating Temperature	Class 2 -20C to +55C
Storage Temperature	Class 2 -30C to +70C
Waterproof (EPIRB)	10m depth for 1 hour
Auto Release Depth	4m maximum

Approvals

Cospas Sarsat Standards	T.001, T.007
Test Standards	IEC61097-2, EN 62368-1, EN 301 489, RTCM SC11000-2

10. Approvals

For approval documents see: <https://oceansignal.com/approvals-documents/>
In addition to Cospas Sarsat Type Acceptance, the EPIRB1 Pro complies with the following National Approvals:

10.5.1 European Union

Hereby, OceanSignal Ltd. declares that the radio equipment type EPIRB1 Pro is in compliance with Radio Equipment Directive 2014/53/EU. The DoC can be found at the following website link: <https://oceansignal.com/approvals-documents/>

10.5.2UK

Complies with UK Radio Equipment Regulation (UKRER):2017

10.5.3USA

Complies with FCC 47 CFR Part 80 and US Coast Guard requirements

10.5.4Canada

Complies with ISSED RSS GEN and RSS182

10.5.5Australia/New Zealand

Complies with AS/NZS 4280.1-2017

11. Registration

It is a legal requirement to register your EPIRB1 Pro with your national authority. Failure to do so may result in prosecution. Accurate registration will help the authorities if your EPIRB1 Pro is activated and may speed up your rescue.

To register your beacon, contact your national registration authority via post, email or online. Provide your 15 digit HEX ID (UIN), 5 digit checksum if required, your contact details and emergency contact information. Some countries also require additional information such as boat type and identification or alternative emergency contacts.

For UK registrations go to: www.gov.uk/406beacon

For USA registrations go to: www.beaconregistration.noaa.gov

For Australia go to: www.amsa.gov.au/beacons

For New Zealand go to: www.beacons.org.nz

Details of other authorities may be found at:
www.406registration.com/countriesupported.aspx

It is important to make sure that registration details are kept up to date and that the authority is advised of change of ownership or disposal of your EPIRB1 Pro.

12. Optional Accessories

ARH1 Pro Replacement Automatic Release Housing

703S-03414

HR1E Replacement Hydrostatic Release Unit

701S-00608

13. Warranty Information

13.1 Limited Warranty

Your Ocean Signal product is warranted against manufacturing defects in materials and workmanship for a period of 2 years from the date of purchase and in accordance with the following conditions.

Ocean Signal will at its discretion, repair or replace faulty product free of charge excluding the cost of shipping. Proof of purchase shall be required in order for a warranty claim to be valid from the original purchaser. All claims shall be made in writing to Ocean Signal or an approved service dealer or distributor.

Ocean Signal shall not be liable to the buyer under the above warranty:

- for any repairs or modifications carried out on the product using parts that are not supplied or approved by the manufacturer Ocean Signal including batteries and for work carried out other than by Ocean Signal or approved service dealers,
- for any part, material or accessory that is not manufactured by Ocean Signal the consumer will be covered by the guarantee / warranty offered to Ocean Signal by the manufacturer or supplier of such a component,
- for product which has not been fully paid for,
- for any product supplied by Ocean Signal to a customer under an alternative warranty or commercial agreement,
- for the cost of shipping product to and from the customer.

The Battery is only warranted until the date of expiry and provided the unit is tested in accordance with the information in the user manual as noted by the electronic witness stored within the product. The following specific item is excluded from this warranty:

- Damage to the antenna

This warranty does not affect your statutory rights.

13.2 Extended Warranty



ENTER YOUR PRODUCT DETAILS TO GAIN THE EXTENDED WARRANTY PERIOD

Apply for free at www.oceansignal.com/warranty

By entering your product details you can add 3 years to the warranty period.
For full details on extended warranty on this product see www.oceansignal.com/warranty.

For further assistance please contact our Technical Service Department.
Email: info@oceansignal.com

Ocean Signal Ltd.
Unit 4, Ocivan Way
Margate
CT9 4NN
United Kingdom

info@oceansignal.com
www.oceansignal.com

